

**THE RADIO  
AMATEUR'S  
HANDBOOK**



**HIRAM PERCY MAXIM**

1869-1936

Father, founder and saviour of organized amateur radio, exponent of its charm and spirit, first president of the American Radio Relay League and of the International Amateur Radio Union

FOURTEENTH EDITION

•

# THE RADIO AMATEUR'S HANDBOOK

BY THE HEADQUARTERS STAFF OF  
THE AMERICAN RADIO RELAY LEAGUE



---

PUBLISHED BY  
THE AMERICAN RADIO RELAY LEAGUE, INC.  
WEST HARTFORD, CONNECTICUT

COPYRIGHT 1936 BY THE AMERICAN RADIO RELAY LEAGUE, INC.

*Copyright secured under the Pan-American Convention.*

*All rights of translation reserved.*

●

First Edition, November, 1926 . . . . .	5,000 copies
Second Edition, First Printing, January, 1927 . . . . .	5,000 copies
Second Edition, Second Printing, April, 1927 . . . . .	10,000 copies
Third Edition, First Printing, October, 1927 . . . . .	10,000 copies
Third Edition, Second Printing, April, 1928 . . . . .	10,000 copies
Fourth Edition, December, 1928 . . . . .	10,000 copies
Fifth Edition, May, 1929 . . . . .	10,000 copies
Sixth Edition, First Printing, November, 1929 . . . . .	10,000 copies
Sixth Edition, Second Printing, March, 1930 . . . . .	10,000 copies
Sixth Edition, Third Printing, June, 1930 . . . . .	7,000 copies
Seventh Edition, October, 1930 . . . . .	25,000 copies
Eighth Edition, April, 1931 . . . . .	25,000 copies
Ninth Edition, First Printing, January, 1932 . . . . .	30,000 copies
Ninth Edition, Second Printing, September, 1932 . . . . .	10,000 copies
Tenth Edition, First Printing, January, 1933 . . . . .	30,000 copies
Tenth Edition, Second Printing, July, 1933 . . . . .	8,750 copies
Eleventh Edition, First Printing, January, 1934 . . . . .	30,000 copies
Eleventh Edition, Second Printing, May, 1934 . . . . .	13,000 copies
Twelfth Edition, First Printing, November, 1934 . . . . .	40,000 copies
Twelfth Edition, Second Printing, July, 1935 . . . . .	8,000 copies
Thirteenth Edition, First Printing, October, 1935 . . . . .	40,000 copies
Thirteenth Edition, Second Printing, February, 1936 . . . . .	33,200 copies
Fourteenth Edition, First Printing, October, 1936 . . . . .	50,000 copies

---

---

PRINTED IN U. S. A. BY  
THE RUMFORD PRESS  
CONCORD, NEW HAMPSHIRE

# THE RADIO AMATEUR'S HANDBOOK

FOURTEENTH EDITION

## FOREWORD

IN PRESENTING the 1937 edition of THE RADIO AMATEUR'S HANDBOOK the publishers again express the hope that it will be found as helpful as the previous editions and enjoy as whole-hearted a reception at the hands of the amateur fraternity.

The *Handbook* is intended both as a reference work for member-operators of the American Radio Relay League and other skilled amateurs and as a source of information to those wishing to participate in amateur radio activities but having little or no idea how to get started. The choice and sequence of material have been planned with particular thought to the needs of the practising amateur but each topic has been so treated as to cover amateur practice all the way from the most simple to the most comprehensive.

As in previous editions, a particular effort has been made to restrict the material treating apparatus design and construction to examples of modern, sound and well-tried practice. Planned as a practical rather than a theoretical work, theoretical discussions have been made as simple and fundamental as possible and the chief effort directed at practical means for securing results — which, after all, is the principal aim of the amateur in radio.

The *Handbook* had its rather modest beginnings in 1925 when Mr. F. E. Handy, for many years the League's communications manager, commenced work on a small manual of amateur operating procedure in which it was deemed desirable to include a certain amount of "technical" information, since an amateur's results are so greatly influenced by the disposition and adjustment of his apparatus. When Mr. Handy completed his manuscript he had written a considerable-sized book of great value. It was published in 1926 and enjoyed an instant success. Produced in the familiar format of the League's magazine, *QST*, it was possible to distribute for a very modest charge a work which in volume of subject matter and profusity of illustration surpassed most available texts selling for several times its price. Mr. Handy revised several successive editions as reprinting became necessary. With the fourth edition, in 1928, he was joined in this duty by the undersigned, who was directing the technical development program which the A.R.R.L. was then conducting for the special purpose of developing new apparatus and new methods which would meet the difficulties imposed upon amateur radio by the provisions of the new international radio treaty which was to take effect in 1929. Three editions appeared under this joint authorship. By that time, extremely rapid technical progress was upon us and it became apparent that the *Handbook* to serve its purpose demanded a frequent and comprehensive rewriting of its technical material. Now in the headquarters establishment of the League at West Hartford there are many technically-skilled amateurs, each a specialist in his field. It was therefore but natural that with the preparation of the seventh edition in 1930 the technical chapters of the *Handbook* should be given into

their hands. Since that time the publication has been a family affair, the joint product of the headquarters staff.

To a total of twenty-two printings the fame of the *Handbook* has echoed around the world. More than three hundred and seventy thousand copies have been distributed at this writing. Its success has been really inspiring. Quantity orders have come from many a foreign land; schools and technical classes have adopted it as a text; but most important of all, it has become the right-hand guide of practical amateurs in every country on the globe. But amateur radio moves with amazing rapidity and the best practices of yesterday are quickly superseded by the developments of to-day. The very success of the book as a publication brings a new responsibility to us, the publishers — the *Handbook* must be kept up to date.

Because the present year has seen further sweeping changes in amateur practice it has been necessary again to undertake a comprehensive revision for this edition. We are happy at the same time again to expand the size of the book. Most of the chapters have been entirely rewritten. All of them have been thoroughly modernized.

This edition again represents the collaboration of many members of the A.R.R.L. staff. The first two chapters are from the pen of Mr. A. L. Budlong, the assistant secretary of the League. The several chapters on fundamental principles, on receiver design and construction and on radio-telephony are the work of Mr. James J. Lamb, the technical editor of *QST*. Mr. George Grammer, the assistant technical editor of *QST*, has again been responsible for the chapters on vacuum tubes and those treating the design and construction of transmitters. The general subject of instruments and measurements has, in this edition, been covered by Mr. Clinton B. DeSoto while the chapters on antennas, power supply and keying have been rewritten by Mr. Donald H. Mix, of the League's technical information service. Mr. Clark C. Rodimon, managing editor of *QST*, has again revised the chapter on station assembly while Mr. Handy, our communications manager, has rewritten the chapters on the A.R.R.L. Communications Department, on operating a station and on message handling. The chapters on ultra-high-frequency working have been prepared by the undersigned.

By no means the least useful feature of this edition is the quite extensive catalog advertising that accompanies it. It is not generally regarded as in good taste to make any editorial reference to the existence of advertising, but this case we believe to be different. To be truly comprehensive as a handbook — to fill all the functions one visualizes with the word "handbook" — this book must bring the reader data and specifications on the manufactured products which are the raw material of amateur radio. Our advertisers have collaborated with us in this purpose by presenting here not mere advertising but catalog technical data. The amateur constructor and experimenter should find it convenient to possess in such juxtaposition both the constructional guidance he seeks and the needed data on his *matériel*. Both are necessary ingredients of the complete standard manual of amateur high-frequency communication.

We shall all feel very happy if the present edition brings as much assistance and inspiration to amateurs and would-be amateurs as have its predecessors.

ROSS A. HULL  
EDITOR

WEST HARTFORD, October, 1936.

THE RADIO AMATEUR'S HANDBOOK  
FOURTEENTH EDITION

CONTENTS

HIRAM PERCY MAXIM. . . . .	<i>Frontispiece</i>
FOREWORD . . . . .	v
THE AMATEUR — HIS CODE OF ETHICS . . . . .	viii
CHAPTER ONE — THE STORY OF AMATEUR RADIO . . . . .	1
CHAPTER TWO — GETTING STARTED . . . . .	9
CHAPTER THREE — FUNDAMENTAL ELECTRICAL PRINCIPLES . . . . .	17
CHAPTER FOUR — RADIO CIRCUIT AND WAVE FUNDAMENTALS . . . . .	34
CHAPTER FIVE — VACUUM TUBES . . . . .	51
CHAPTER SIX — RECEIVER CIRCUIT DESIGN . . . . .	87
CHAPTER SEVEN — RECEIVER CONSTRUCTION . . . . .	114
CHAPTER EIGHT — PRINCIPLES OF TRANSMITTER DESIGN . . . . .	141
CHAPTER NINE — TRANSMITTER CONSTRUCTION . . . . .	176
CHAPTER TEN — KEYING . . . . .	205
CHAPTER ELEVEN — FUNDAMENTALS OF RADIOTELEPHONY . . . . .	216
CHAPTER TWELVE — BUILDING RADIOTELEPHONE TRANSMITTERS . . . . .	228
CHAPTER THIRTEEN — RECEIVERS FOR THE ULTRA-HIGH FRE- QUENCIES . . . . .	242
CHAPTER FOURTEEN — ULTRA-HIGH-FREQUENCY TRANSMITTERS . . . . .	258
CHAPTER FIFTEEN — POWER SUPPLY . . . . .	275
CHAPTER SIXTEEN — ANTENNAS . . . . .	300
CHAPTER SEVENTEEN — INSTRUMENTS AND MEASUREMENTS . . . . .	328
CHAPTER EIGHTEEN — ASSEMBLING THE STATION . . . . .	342
CHAPTER NINETEEN — OPERATING A STATION . . . . .	351
CHAPTER TWENTY — MESSAGE HANDLING . . . . .	366
CHAPTER TWENTY-ONE — LEAGUE OPERATING ORGANIZATION . . . . .	379
APPENDIX . . . . .	389
INDEX . . . . .	417
CATALOG ADVERTISING SECTION . . . . .	425

---

PUBLISHED BY  
THE AMERICAN RADIO RELAY LEAGUE, INC.  
WEST HARTFORD, CONNECTICUT

THE RADIO AMATEUR'S HANDBOOK  
FOURTEENTH EDITION

•

# O U R C O D E

**I**

*The Amateur is Gentlemanly.* He never knowingly uses the air for his own amusement in such a way as to lessen the pleasure of others. He abides by the pledges given by the A.R.R.L. in his behalf to the public and the Government.

**II**

*The Amateur is Loyal.* He owes his amateur radio to the American Radio Relay League, and he offers it his unswerving loyalty.

**III**

*The Amateur is Progressive.* He keeps his station abreast of science. It is built well and efficiently. His operating practice is clean and regular.

**IV**

*The Amateur is Friendly.* Slow and patient sending when requested, friendly advice and counsel to the beginner, kindly assistance and coöperation for the broadcast listener; these are marks of the amateur spirit.

**V**

*The Amateur is Balanced.* Radio is his hobby. He never allows it to interfere with any of the duties he owes to his home, his job, his school, or his community.

**VI**

*The Amateur is Patriotic.* His knowledge and his station are always ready for the service of his country and his community.

---

---

PUBLISHED BY  
THE AMERICAN RADIO RELAY LEAGUE, INC.  
WEST HARTFORD, CONNECTICUT



# I

## The Story of Amateur Radio

### HOW IT STARTED; THE PART PLAYED BY THE A.R.R.L.

AMATEUR radio represents, to upwards of fifty-five thousand people, the most satisfying, most exciting of all hobbies. Forty thousand of these enthusiasts are located in the United States, for it is this country which gave birth to the movement and which, since the beginning, has represented its stronghold.

When radio broadcasting was first introduced to the public some years ago it instantly caught the fancy of millions of people all over the world. Why? Because it fired their imagination — because it thrilled them to tune in on a program direct from some distant point, to hear speech and music that was at that moment being transmitted from a city hundreds and even thousands of miles away. To be sure there was also a certain amount of entertainment value, and it is true that as the years have passed this phase has become uppermost in the minds of most listeners; yet the thrill of "dx" is still a major factor in the minds of hundreds of thousands of people, as witness the present growing popularity of international short-wave reception of foreign programs.

That keen satisfaction of hearing a distant station is basic with the radio amateur but it has long since been superseded by an even greater lure, and that is the thrill of *talking* with these distant points! On one side of your radio

amateur's table is his short-wave receiver; on the other side is his private (and usually home-made) short-wave transmitter, ready at the throw of a switch to be used in calling and "working" other amateurs in the United States, in Canada, Europe, Australia, every

corner of the globe! Even a low-power transmitter using nothing more ambitious than one or two receiving-type tubes makes it possible to develop friendships in every State in the Union, in dozens of countries abroad. Of course, it is not to be expected that the first contacts will necessarily be with foreign amateurs. Experience in adjusting the simple transmitter, in using the right frequency band at the right time of day when foreign stations are on the air, and practice in operating are necessary before

AMATEUR radio is the means of communication with others on equal terms, of finding friendship, adventure and prestige while seated at one's own fireside. In picking his human contacts out of the air the amateur is not seen by them. He is not known by the clothes he wears but by the signals he emits. He enters a new world whose qualifications for success are within his reach. There are no century-old class prejudices to impede his progress. He enters a thoroughly democratic world where he rises or falls by his own efforts. When he is W9XYZ, a beginner, the radio elders help him willingly, and when he becomes W9XYZ the record-breaker and efficient traffic-handler, he willingly helps the younger generation. Without a pedigree, a chauffeur, or an old master decorating his living room he can become a prince — of the air. At the close of the day, filled with the monotonous routine of the machine age, he can find adventure, vicarious travel, prestige and friendship by throwing in the switch and pounding his signals into the air.

DR. RAYMOND V. BOWERS,  
Yale University

communication will be enjoyed with amateurs of other nationalities. But patience and experience are the sole prerequisites; neither high power nor expensive equipment is required.

Nor does the personal enjoyment that comes from amateur radio constitute its only benefit. There is the enduring satisfaction that comes from doing things with the apparatus put together by our own skill. The process of designing and constructing radio equipment develops real engineering ability. Operating an amateur station with even the simplest equipment like-

# The Radio Amateur's Handbook . . . . .

wise develops operating proficiency and skill. Many an engineer, operator or executive in the commercial radio field got his practical background and much of his training from his amateur work. So, in addition to the advantages of amateur radio as a hobby, the value of systematic amateur work to a student of almost every branch of radio cannot well be overlooked. An increasing number of radio services, each expanding in itself, require additional personnel, technicians, operators, inspectors, engineers and executives and in every field a background of amateur experience is regarded as valuable.

● How did amateur radio start? What developments have brought it to its present status of a highly-organized and widespread movement?

It started shortly after Marconi had astounded the world with his first experiments proving that telegraph messages actually could be sent between distant points without wires. Marconi was probably the first amateur — indeed, the distinguished inventor so likes to style himself even today. But amateur radio as we think of it was born when the first private citizen saw in the new marvel a means for personal communication with others and set about learning enough of the new art to build a home-made station, hoping that at least one of his friends would do the same so he could have someone to talk to. Object: the fun and enjoyment of “wireless” communication with a few friends. Urge: the thrill of DX (one to five miles — maybe!). That was thirty-odd years ago.

Amateur radio's subsequent development may be divided into two periods, the first before and the second after the World War.

Pre-war amateur radio bore little resemblance to the art as we know it today, except in principle. The equipment, both transmitting and receiving, was of a type now long obsolete. The range of even the highest-powered transmitters, under the most favorable conditions, would be scoffed at by the rankest beginner today. No United States amateur had ever heard the signals of a foreign amateur, nor

had any foreigner ever reported hearing an American. The oceans were a wall of silence, impenetrable, isolating us from every signal abroad. Even trans-continental DX had to be accomplished in relays. “Short waves” meant 200 meters; the entire wavelength spectrum below 200 meters was a vast silence — no signal ever disturbed it.

Years were to pass before its phenomenal possibilities were to be suspected.

Yet the period was notable for a number of accomplishments. It saw the number of amateurs in the United States increase to approximately 4,000 by 1917. It witnessed the first appearance of radio laws, licensing, wavelength specifications for the various services. (“Amateurs? — oh, yes — well, stick 'em on 200 meters; it's no good for anything; they'll never get out of their own back yards with it.”) It saw an increase in the range of amateur stations to such unheard-of distances as 500 and, in some cases, even 1,000 miles, with

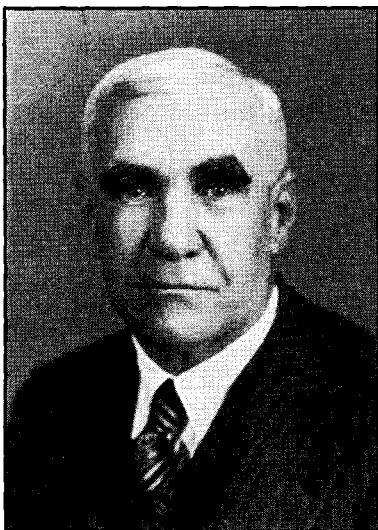

DR. EUGENE C. WOODRUFF, W8CMP  
President, A.R.R.L.

U. S. amateurs beginning to wonder, just before the war, if there were amateurs in other countries across the seas and if — daring thought! — it might some day be possible to span the Atlantic with 200-meter equipment. Because all long-distance messages had to be relayed, it saw relaying developed to a fine art — and what a priceless accomplishment that ability turned out to be later when our government suddenly needed dozens and hundreds of skilled operators for war service! Most important of all, the pre-war period witnessed the birth of the American Radio Relay League, the amateur organization whose fame was to travel to all parts of the world and whose name was to be virtually synonymous with subsequent amateur progress and short-wave development. Conceived and formed by the famous inventor and amateur, the late Hiram Percy Maxim, it was formally launched in early 1914 and was just beginning to exert its full force in amateur activities when this country declared war on Germany and by that act sounded the knell for amateur radio for the next two and one-half years. By presidential direction every amateur station was disman-

# . . . . . The Story of Amateur Radio

tled. Within a few months three-fourths of the amateurs of the country were serving with the armed forces of the United States as operators and instructors.

● Few amateurs today realize that the war not only marked the close of the first phase of amateur development but came very near marking its end for all time. The fate of amateur radio was in the balance in the days immediately following declaration of the Armistice, in 1918. The government, having had a taste of supreme authority over all communications in wartime, was more than half inclined to keep it; indeed, the war had not been ended a month before Congress was considering legislation that would have made it impossible for the amateur radio of old ever to be resumed. President Maxim rushed to Washington, pleaded, argued; the bill was defeated. But there was still no amateur radio; the war ban continued in effect. Repeated representations to Washington met only with silence; it was to be nearly a year before licenses were again to be issued.

In the meantime, however, there was much to be done. Three-fourths of the former amateurs had gone to France; many of them would never come back. What of those who had returned? Would they be interested, now, in such things as amateur radio; could they be brought back to help rebuild the League? Mr. Maxim determined to find out and called a meeting of such members of the old Board of Directors as he could locate. Eleven men, several still in uniform, met in New York and took stock of the situation. It wasn't very encouraging: amateur radio still banned by law, former members of the League scattered no one knew where, no League, no membership, no funds. But those eleven men financed the publication of a notice to all the former amateurs that could be located, hired Kenneth B. Warner as the League's first paid secretary, floated a bond issue among old League members to obtain money for immediate running expenses, bought the magazine *QST* to be the League's official organ and dunned officialdom until the wartime ban was lifted and amateur radio resumed again. Even before the ban was lifted in October, 1919, old-timers all over the country were flocking back to the League, renewing friendships, planning for the future. When licensing was resumed there was a head-long rush to get back on the air. No doubt about it now — interest in amateur radio was as great as ever!

From the start, however, it took on new aspects. The pressure of war had stimulated technical development in radio; there were new

types of equipment, principally the vacuum tube, which was being used for both receivers and transmitters. Amateurs immediately adapted the new apparatus to 200-meter work. Ranges promptly increased; soon it was possible to bridge the continent with but one intermediate relay. Shortly thereafter stations on one coast were hearing those on the other direct!

These developments had an inevitable result. Watching DX come to represent 1,000 miles, then 1,500 and then 2,000, amateurs wondered about that ole debbil ocean. Could we get across? We knew now that there were amateurs abroad. We knew, too, that their listening for our signals was still fruitless, but there was a justifiable suspicion that their unfamiliarity with 200-meter equipment had something to do with it. So in December, 1921, the A.R.R.L. sent abroad one of our most prominent amateurs, Paul Godley, with the best amateur receiving equipment available. Tests were run, and thirty American amateur stations were heard in Europe! The news electrified the amateur world. In 1922 another trans-Atlantic test was carried out; this time 315 American calls were logged by European ama-

Reprinted by QST for October 1919 (Vol. III, No. 5)

## BAN OFF!

**THE JOB IS DONE, AND THE A.R.R.L. DID IT**

See next QST for details

---

21706-65  
NAVY DEPARTMENT  
NAVAL COMMUNICATION SERVICE  
Office of the Director  
Washington, Sept. 26, 1919.

Sir:  
The Secretary of the Navy authorizes the announcement that, effective October 1, 1919, all restrictions on Amateur and amateur radio stations are removed. This applies to amateur stations, including and experimental stations of islands and vessels, and to all other stations except those used for the purpose of transmitting of transmitting commercial traffic of any character, including the business of the

service of the stations. The restrictions on station building suspended under license remain in effect until the President declares that a state of peace exists.  
Attention is invited to the fact that all licensees for transmitting stations have accepted and that it will be necessary for the licensees to apply to the Commissioner of Navigation, Department of Commerce, for new licenses. In so far as amateurs are concerned, calls previously in previous status under the Department of Commerce.  
Very respectfully,  
Capt. E. D. Westerman,  
Commander, U. S. Navy,  
Assistant Director Naval Communications

---

COMING!

The Biggest Boom in Amateur Radio History.

AMATEURS: Order your apparatus and get your licenses!  
MANUFACTURERS & DEALERS: Tell us what you have!  
NON-SUBSCRIBERS: Get in your QST subscription  
At Once - Immediately - To-day - Now!

## WE'RE OFF!

teurs and, what was more, one French and two British stations were heard on this side.

Everything now was centered on one objective: two-way communication across the Atlantic by amateur radio! It *must* be possible — but somehow we couldn't quite make it.

# The Radio Amateur's Handbook . . . . .

Further increases in power were out of the question; many amateurs already were using the legal maximum of one kilowatt. Better receivers? We already had the superheterodyne; it didn't seem possible to make any very great

conferences partitioned off various bands of frequencies for all the different services clamoring for assignments. Although thought was still centered on 100 meters, League officials at the first of these conferences, in 1924, came to the conclusion that the surface had probably only been scratched, and wisely obtained amateur bands not only at 80 meters, but at 40 and 20 and 10 and even 5 meters.

Many amateurs promptly jumped down to the 40-meter band. A pretty low wavelength, to be sure, but you never could tell about these short waves. Forty was given a whirl and responded by enabling two-way communication with Australia, New Zealand and South Africa.

How about 20? It was given a try-out and immediately showed entirely unexpected possibilities in enabling an east-coast amateur to

communicate with another on the west coast, direct, at high noon. The dream of amateur radio — daylight DX!

● From that time to the present represents a period of unparalleled accomplishment. The short waves proved a veritable gold mine. Country after country came on the air, until the confusion became so great that it was necessary to devise a system of international intermediates in order to distinguish the nationality of calls. The League began issuing what are known as WAC certificates to those stations proving that they had worked all the continents. Nearly two thousand such certificates have been issued. Representatives of the A.R.R.L. went to Paris several years ago



IN GODLEY'S TENT, ON THE SHORES OF SCOTLAND

advance in that direction.

Well, how about trying another wavelength, then? We couldn't go up, but we could go down. What about those wavelengths below 200 meters? The engineering world said they were worthless — but then, they'd said that about 200 meters, too. There have been many wrong guesses in history. So in 1922 the technical editor of *QST* carried on some tests between Hartford and Boston on 130 meters. The results were encouraging. Early in 1923 the A.R.R.L. sponsored a series of organized tests on wavelengths down to 90 meters and it was noted that as the wavelength dropped the reported results were better. A growing excitement began to filter into the amateur ranks. It began to look as though we'd stumbled on something!

And indeed we had. For in November, 1923, after some months of careful preparation, two-way amateur communication across the Atlantic finally became an actuality when Schnell, 1MO, and Reinartz, 1XAM, worked for several hours with SAB, Deloy, in France, all three stations using a wavelength of about 110 meters!

There was the possibility, of course, that it was a "freak" performance, but any suspicions in that direction were quickly dispelled when additional stations dropped down to 100 meters and found that they, too, could easily work two-way across the Atlantic. The exodus from the 200-meter region started.

By 1924 the entire radio world was agog and dozens of commercial companies were rushing stations into the 100-meter region. Chaos threatened until the first of a series of radio

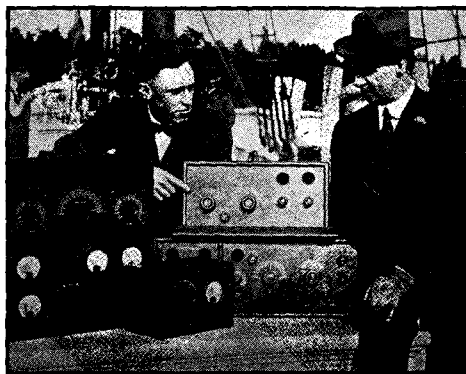

DON MIX, COMMANDER MACMILLAN, AND WNP, 1923

• • • • • **The Story of Amateur Radio**

and deliberated with the amateur representatives of twenty-two other nations. On April 17, 1925, this conference formed the International Amateur Radio Union — a union of national amateur societies. We have discovered that the amateur as a type is the same the world over.

Nor has experimental development been lost sight of in the enthusiasm incident to international amateur communication. The experimentally-minded amateur is constantly at work conducting tests in new frequency bands, devising improved apparatus for amateur receiving and transmitting, learning how to operate two and three and even four stations where previously there was room enough for only one.

In particular, the amateur experimenter presses on to the development of the higher frequencies represented by the wavelengths below 20 meters, territory only a short time ago regarded by even most amateurs as comparatively unprofitable operating ground. On ten meters, experiments sponsored by the A.R.R.L. in directive transmission resulted in signals from a Cape Cod station being logged for days on end in New Zealand and reported in England, Canada and many parts of the United States; many amateurs now devote a considerable portion of their operating time to "ten" during certain periods of the year when conditions are particularly favorable for this frequency.

The amateur's experience with five meters is especially representative of his initiative and resourcefulness, and his ability to make the most of what is at hand. In 1924 first amateur experiments in the vicinity of 56 mc. indicated the band to be practically worthless for distance work; signals at such frequencies appeared capable of being heard only to "horizon range." But the amateur turns even such apparent disadvantages to use. If not suitable for long-distance work, at least it was ideal for "short-haul" communication. Beginning in 1931, then, there took place a tremendous amount of activity in 56-mc. work by hundreds of amateurs all over the country and a complete new line of transmitters and receivers was developed to meet the special conditions incident to communicating at these ultra-high frequencies. In 1934 additional impetus was given to this band when experiments by the A.R.R.L. with directive antennas resulted in remarkably consistent two-way communication over distances of more than 100 miles, without the aid of "hilltop" locations. While atmospheric conditions appear to have a great

deal to do with 5-meter DX, many thousands of amateurs are now spending much of their time in the 56-mc. region, some having worked as many as four or five hundred different stations on that band at distances up to several hundred miles.

Most of the technical developments in amateur radio have come from the amateur ranks. Many of these developments represent valuable contributions to the art, and the articles about them are as widely read in professional circles as by amateurs. At a time when only a few broadcast engineers in the country knew what was meant by "100% modulation" the technical staff of the A.R.R.L. was publishing

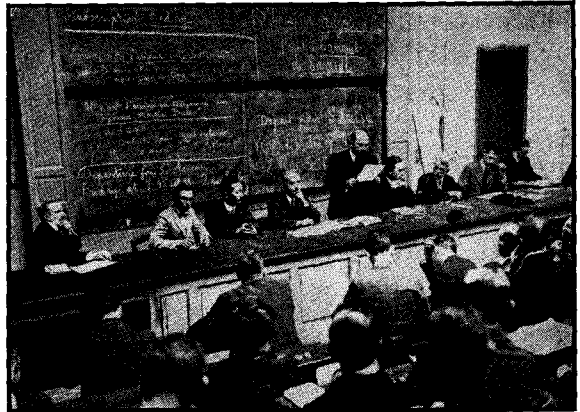

THE FIRST INTERNATIONAL AMATEUR CONGRESS, 1925

articles in *QST* urging amateur 'phones to embrace it and showing them how to do it. When interest quickened in five-meter work, and experiments showed that the ordinary regenerative receiver was practically worthless for such wavelengths, it was the A.R.R.L. that developed practical super-regenerative receivers as the solution to the receiver problem. From the League's laboratory, too, came in 1932, the single-signal superheterodyne — the world's most advanced high-frequency radiotelegraph receiver. In 1933 came another great contribution to transmitter practice in the form of the tri-tet crystal oscillator, simplifying the high-frequency crystal controlled transmitter by reducing the number of stages necessary and improving transmitter reliability, stability and efficiency. In 1934 the commercial production of r.f. power pentodes came as a result of the A.R.R.L. Hq. technical staff's urging and demonstration of their advantages. 1935 saw the development of the super-infragenerator (S.I.G.) receiver by the League's technical staff, giving to ultra-high-frequency communication a

# The Radio Amateur's Handbook . . . . .

method of reception comparable with that available from superheterodynes on lower frequencies. And in 1936 came the "noise-silencer" attachment for super-heterodynes, permitting for the first time satisfactory high-frequency reception through the more common forms of man-made electrical interference.

● Amateur radio is one of the finest of hobbies, but this fact alone would hardly merit such whole-hearted support as was given it by the United States government at recent international conferences. There must be other reasons to justify such backing. There are. One of them is a thorough appreciation by the Army and Navy of the value of the amateur as a source of skilled radio personnel in time of war. The other is best described by the words "public service."

We have already seen 3,500 amateurs contributing their skill and ability to the American cause in the Great War. After the war it was only natural that cordial relations should prevail between the Army and Navy and the amateur. Several things occurred in the next few years to strengthen these relations. In 1924, when the U. S. dirigible *Shenandoah* made a tour of the country, amateurs provided continuous contact between the big ship and the ground. In 1925 when the United States battle fleet made a cruise to Australia and the Navy wished to test out short-wave apparatus for future communication purposes, it was the League's Traffic Manager who was in complete charge of an experimental high-frequency set on the U.S.S. *Seattle*.

Definite friendly relations between the amateur and the armed forces of the Government were cemented in 1925. In this year both the Army and the Navy came to the League with proposals for amateur coöperation. The radio Naval Reserve and the Army-Amateur Net are the outgrowth of these proposals.

The public service record of the amateur is a brilliant one. These services can be roughly divided into two classes: emergencies and expeditions. It is regrettable that space limitations preclude detailed mention of amateur work in both these classes, for the stories constitute some of the high-lights of amateur accomplishment. As it is, only a general outline can be given.

Since 1913, amateur radio has been the principal, and in many cases the only, means of outside communication in nearly one hundred storm and flood emergencies in this country. Among the most noteworthy were the Florida hurricanes of 1926, 1928 and 1935, the Missis-

issippi and New England floods of 1927 and the California dam break of 1928. During 1931 there were the New Zealand and Nicaraguan earthquakes, and in 1932 floods in California and Texas; outstanding in 1933 was the earthquake in southern California. In 1934 further floods in California and Oklahoma resulted in notable amateur coöperation. In 1936 the floods of the eastern United States saw the greatest emergency effort ever performed by amateurs and the story of this work in the May and June, 1936, issues of *QST* should be read by every amateur. In all these and many others, amateur radio played a major role in the rescue work and amateurs earned world-wide commendation for their resourcefulness in effecting communication where all other means failed.

It is interesting to note that one of the principle functions of the Army-Amateur network is to furnish organized and coöordinated amateur assistance in the event of storm and other emergencies in this country. In addition, Red Cross centers in various parts of the United States are now furnished with lists of amateur stations in the vicinity as a regular part of their emergency measures program.

Amateur coöperation with expeditions started in 1923, when a League member, Don Mix, of Bristol, Conn., accompanied MacMillan to the Arctic on the schooner *Bowdoin* in charge of an amateur set. Amateurs in Canada and the United States provided the home contact. The success of this venture was such that MacMillan has never since made a trip without carrying short-wave equipment and an amateur to operate it.

Other explorers noted this success and made inquiries to the League regarding similar arrangements for their journeys. In 1924 another expedition secured amateur coöperation; in 1925 three benefited by amateur assistance, and by 1928 the figure had risen to nine for that year alone. Each year since then has seen League headquarters in receipt of more and more requests for such service, until now a total of more than a hundred voyages and expeditions have been assisted. Today practically no exploring trip starts from this country to remote parts of the world without making arrangements to keep in contact through the medium of amateur radio.

Emergency relief, expeditionary contact, and countless instances of other forms of public service, rendered as they always have been and always will be, without hope or expectation of material reward, have made amateur radio one of the integral parts of our national life.

### The American Radio Relay League

● The American Radio Relay League is today not only the spokesman for amateur radio in this country but is the largest amateur organization in the world. It is strictly of, by and for amateurs, is non-commercial and has no stockholders. The members of the League are the owners of the A.R.R.L. and *QST*.

The League is organized to represent the amateur in legislative matters. It is pledged to promote interest in two-way amateur communication and experimentation. It is interested in the relaying of messages by amateur radio. It is concerned with the advancement of the radio art. It stands for the maintenance of fraternalism and a high standard of conduct. One of its principal purposes is to keep amateur activities so well conducted that the amateur will continue to justify his existence. As an example of this might be cited the action of the League in sponsoring the establishment of a number of Standard Frequency Stations throughout the United States; installations equipped with the most modern available type of precision measuring equipment, and transmitting "marker" signals on year-round schedules to enable amateurs everywhere to accurately calibrate their apparatus.

The operating territory of the League is divided into fourteen United States and six Canadian divisions. You can find out what division you are in by consulting *QST* or the *Handbook*. The affairs of the League are managed by a Board of Directors. One director is elected every two years by the membership of each United States division, and a Canadian General Manager is elected every two years by the Canadian membership. These directors then choose the president and vice-president, who are also directors, of course. No one commercially engaged in selling or manufacturing radio apparatus or literature can be a member of the Board or an officer of the League.

The president, vice-president, secretary, treasurer and communications manager of the League are elected or appointed by the Board



THE WOUFF-HONG

of Directors. These officers constitute an Executive Committee which, under certain restrictions, decides how to apply Board policies to specific matters that arise between Board meetings.

The League owns and publishes the magazine *QST*. *QST* goes to all members of the League each month. It acts as a monthly bulletin of the League's organized activities. It serves as a medium for the exchange of ideas. It fosters amateur spirit. Its technical articles are renowned. *QST* has grown to be the "amateur's bible" as well as one of the foremost radio magazines in the world. The profits *QST* makes are used in supporting League activities. Membership dues to the League include a subscription to *QST* for the same period.

The extensive field organization of the Communications Department coordinates practical station-operation throughout North America.

### Headquarters

● From the humble beginnings recounted in the story of amateur radio, League headquarters has grown until now it occupies an entire floor in a new office building and employs more than two dozen people.

Members of the League are entitled to write to Headquarters for information of any kind, whether it concerns membership, legislation, or general questions on the construction or operation of amateur apparatus. If you don't find the information you want in *QST* or the *Handbook*, write to A.R.R.L. Headquarters, West Hartford, Connecticut, telling us your problem. All replies are directly by letter; no charge is made for the service.

If you come to Hartford, drop out to Headquarters at West Hartford. Visitors are always welcome.

### International Amateur Radio Union

The I.A.R.U. is a federation of twenty-seven national amateur radio societies in the principal nations of the world. Its purposes are the promotion and coordination of two-way communication between the amateurs of the various countries, the effecting of cooperative

# The Radio Amateur's Handbook . . . . .

agreements between the various national societies on matters of common welfare, the advancement of the radio art, the encouragement of international fraternalism, and the promotion of allied activities. Perhaps its greatest service lies in representing the amateurs of the world at international telecommunications conferences and technical consulting committee (C.C.I.R.) meetings.

The headquarters society of the Union is the American Radio Relay League. All correspondence should be addressed to 38 LaSalle Road, West Hartford, Conn., U. S. A.

The I.A.R.U. issues WAC (Worked-All-Continents) certificates to amateurs who qualify for this award. The regulations, in brief, stipulate that the applicant must have worked other amateurs in each of the six recognized continental areas of the world, supplying QSL cards or other indisputable proof of two-way contact in connection with his application; and that he must be a member of the member-society of the Union for the country in which he resides. In countries where no member-society exists the certificate may be secured upon payment of a fee of 50¢ to cover mailing costs. Two kinds of certificates are issued, one for radiotelegraph work and one for radiotelephone.

## WIMK

● For many years it was the dream of the League's officers that some day Headquarters would be able to boast a real "he-station." In 1928 this dream became an actuality, and the League today owns a thoroughly modern amateur station, operating under the call WIMK.

The current operating schedules of WIMK may be obtained by writing the Communications Department at Headquarters or by consulting the current issue of *QST*. While much of the operating time is devoted to prearranged schedules, the station is always ready at other times for a call from any amateur.

## Traditions

● As the League has come down through the years, certain traditions have become a part of amateur radio.

*The Old Man* with his humorous stories on "rotten radio" was one of amateur radio's principal figures. Beginning in 1915 his pictures of radio and radio amateurs as revealed by stories in *QST* were characteristic and inimitable. There was much speculation in ama-

teur circles concerning the identity of T.O.M., but in twenty years of writing he never once gave a clue to his real name or call.

*The Wouff-Hong* is amateur radio's most sacred symbol and stands for the enforcement of law and order in amateur operation. It came into being originally in a story by T.O.M. For some time it was not known just what the Wouff-Hong looked like, but in 1919 The Old Man himself supplied the answer by sending in to League Headquarters the one and only original Wouff-Hong, shown here. It is now framed and hangs on the wall of the Secretary's office at A.R.R.L. Headquarters.

## Joining the League

● The best way to get started in the amateur game is to join the League and start reading *QST*. Inquiries regarding membership should be addressed to the Secretary, or you can use the convenient application blank in the rear of this book. An interest in amateur radio is the only qualification necessary in becoming a member of the A.R.R.L. Ownership of a station and knowledge of the code are *not* prerequisites. They can come later. According to a constitutional requirement, however, only those members who possess an amateur station or operator license are entitled to vote in director elections.

Learn to let the League help you. It is organized solely for that purpose, and its entire headquarters personnel is trained to render the best assistance it can to you in solving your amateur problems. If, as a beginner, you should find it difficult to understand some of the matter contained in succeeding chapters of this book, do not hesitate to write the Information Service stating your trouble. Perhaps, in such a case, it would be profitable for you to send for a copy of a booklet published by the League especially for the beginner and entitled "How to Become a Radio Amateur." This is written in simple, straightforward language, and describes from start to finish the building of a single simple amateur installation. The price is 25 cents, postpaid.

Every amateur should read the League's magazine *QST* each month. It is filled with the latest amateur apparatus developments, "dope" on current expeditions which use short-wave radio for contact with this country, and the latest "ham" news from your particular section of the country. A sample copy will be sent you for 25 cents if you are unable to obtain one at your local newsstand.



# 2

## Getting Started

### THE AMATEUR BANDS—LEARNING THE CODE— OBTAINING LICENSES

HAVING related, briefly, the origin and development of amateur radio in this country, we can now go on to the more practical business of describing in detail how to get in on the amateur radio of today. Subsequent chapters will treat of receiver and transmitter construction and adjustment, station operation, etc. This chapter deals with the first two *bêtes noires* of every beginning amateur—learning the code and getting your licenses.

A high-frequency (short-wave) receiver alone will bring you hours of pleasure and will repay the little effort necessary to assemble it. Sooner or later, however, it is probable that you will build yourself either a radiotelephone or radiotelegraph transmitter. While many amateurs build 'phone transmitters, the majority both in this country and abroad operate radiotelegraph sets. There are several reasons for this. First, the code must be learned regardless of whether you operate a 'phone or telegraph set; the United States government won't issue any kind of amateur license without a code test. Secondly, radiotelegraph apparatus is far less expensive to build and less complicated to adjust than radiophone apparatus; less equipment and power are required and fewer tubes used. And lastly, code signals will usually cover four or five times the distance possible from the same or more complicated radiophone equipment, and are less susceptible to interference, fading and distortion.

There is nothing particularly difficult incident to taking your place in the ranks of licensed amateurs. The necessary steps are first, to learn the code, second, to build a receiver and a transmitter and third to get your amateur licenses and go on the air. Don't let any of these worry you. Thousands of men and women between the ages of 15 and 60 have mastered the code without difficulty by the exercise of a little patience and perseverance; these same thousands have found that only a

moderate amount of study is necessary to prepare for the examination required by the government of all applicants for the combination station-operator license which every amateur must have before actually going on the air. We will treat of both of these subjects in detail later in this chapter.

Nor should you doubt your ability to build short-wave receivers and transmitters. The simpler types of receiver and transmitter described further on in this *Handbook* can be assembled and put into operation by anyone capable of using a screwdriver, a soldering iron and a little common sense. Of course, there are advanced forms of amateur equipment that are intricate, complicated to build, and more difficult to understand and adjust, but it is not necessary to resort to them to secure results in amateur radio, and it would be best to avoid them until the rudiments of the game have been learned.

#### Our Amateur Bands

● Most people, because they have never heard anything else, are prone to think of broadcasting as the most important radio service. To such people a few nights listening in on the high frequencies (wavelengths below the broadcast band) will be a revelation. A horde of signals from dozens of different types of services tell their story to whoever will listen. Some stations send slowly and leisurely. Even the beginner can read them. Others race along furiously so that whole sentences become meaningless buzzes. There are both telegraph and telephone signals. Press messages, weather reports, transocean commercial radiotelephone and telegraph messages, high frequency international broadcasting of voice and music, transmissions from government and experimental stations including picture transmission and television services, airplane dispatching, police broadcasts, and signals from private yachts and expeditions exploring the remote

# The Radio Amateur's Handbook . . . . .

parts of the earth jam the short wave spectrum from one end to the other.

Sandwiched in among all these services are the amateurs, thousands of whose signals may be heard every night in the various bands set apart by International Treaty for amateur operation. These bands are in approximate

interference. Code practice transmissions are made in this band for beginning amateurs and many beginners may be heard in this region making their first two-way contact with each other. The band is one of our "widest" from the standpoint of the number of stations that may be comfortably accommodated. In the

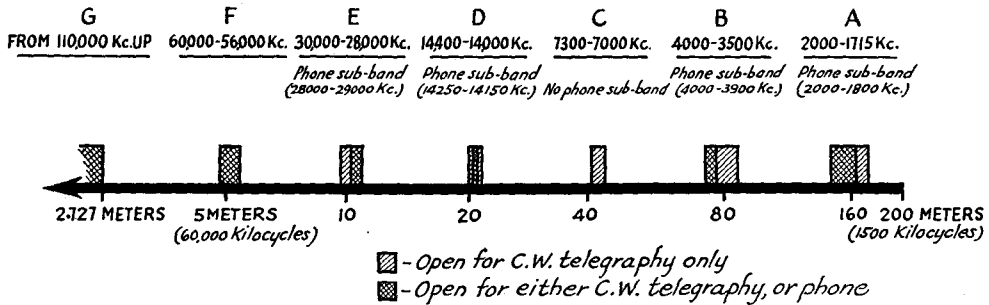

harmonic relation to each other; their position in the short wave spectrum and their relative widths are shown in the sketch.

Many factors have to be considered in picking a certain frequency band for a certain job, especially the distance and the time of day when communication is desired. But in addition to daily changes, there are seasonal changes, and in addition a long-time change in atmospheric conditions which seems to coincide closely with the cycle of sun-spot or solar activity which is completed approximately each eleven years. The reliability of communication on a given frequency at a given time of day, the suitability of a given band for traffic or DX, the desires of the individual amateur in choosing his circle of friends with whom he expects to make contact on schedule, the amount of interference to be expected at certain hours, and the time of day available for operating — all influence the choice of an operating frequency. Many amateurs can use any one of the several available frequency bands at will. Let us now discuss briefly the properties peculiar to each of them.

*The 1715-kc. band*, which carried all our activity before experimenters opened the way to each of the higher frequency bands in turn, always served amateurs well for general contact between points all over the country. There was a short period, during the height of development of the higher frequencies, when activity in this band dwindled, but it is again greatly on the increase.

The band is popular especially for radiotelephone work. The very fact that it is less congested and occupied makes it an extremely attractive band for the amateur operator who would communicate effectively and avoid

next year or so, it may be expected to take more of the present properties of the 3500-kc. region, and its use by amateurs continue to increase. The band is open to amateur television and picture transmission. If you are just getting on the air, plan to use this band. If you have been working on higher frequencies include this band in your plans for 1937 — or you will be missing an important part of amateur radio.

*The 3500-kc. band* has, in recent years, been regarded as best for all consistent domestic communication. It is good for coast-to-coast work at night all the year except for a few summer months. It has been recommended for all amateur message-handling over medium distances (1,000 miles for example). Much of the friendly human contact between amateurs takes place in the 3500-kc. band. It is the band from which we have made excursions to the higher frequencies on occasions when foreign contacts were desired. At the present time this band is exhibiting many of its former DX properties, signals from amateur stations in this country being reported from South Africa, New Zealand and other remote points, and phone signals heard in Europe. As the winter evening advances, the well-known "skip effect" (explained in detail in Chap. Four) of the higher frequencies has made itself known, the increased range of the "sky wave" brings in signals from the other coast and the increased range also brings in more stations, so that the band appears busier.

*The 7000-kc. band* has been the most popular band for general amateur DX work for some years. It is useful mainly at night for contacts with the opposite coast, or with foreign countries. Power output does not limit the range

# Getting Started

of a station to the same extent as when working on the lower frequency bands discussed above. However, the band is more handicapped by congestion in the early evenings and more subject to the vagaries of skip-effect and uncertain transmission conditions than are the lower frequency bands, but not limited in usefulness by these things to the same extent as the 14-mc. band. The 7000-kc. band is satisfactory for working distances of several hundred miles in daylight. It is generally considered the most desirable night band for general DX work in spite of difficulties due to interference. This band may be expected to continue good daylight DX characteristics during 1937 if predictions based on the sun-spot cycle are correct, and at the same time, while great possibilities will exist for evening work, it is likely to be inconsistent and unreliable occasionally during the late evenings.

The 14,000-kc. or 14-mc. band is the very best frequency to use to cover great distances in daylight. In fact it is the *only* band generally useful for daylight DX contacts (QSO's) over coast-to-coast and greater distances. Communication over long distances will usually remain good during the early evenings and surprising results can be obtained then, too.

Using these higher frequencies there is often difficulty in talking with stations within three or four hundred miles, while greater distances than this (and very short distances within ten or twenty miles of a station) can be covered with ease. The reason that 14-mc. signals are less useful for general amateur DX late evenings is because the "skip" increases during darkness until the "sky wave" covers greater than earthly distances. The band, while one of the very best for the amateur interested in working foreign stations without much difficulty from domestic interference, is sometimes subject to sudden fluctuations in transmitting conditions.

The 28,000-kc. (28-mc.) band is principally an experimental amateur band at the present time. It combines both the long-distance characteristics of the 14-mc. band and some of the local advantages of the 56-mc. band, but its long-

•••••	A
•••••	B
•••••	C
•••••	D
•••••	E
•••••	F
•••••	G
•••••	H
•••••	I
•••••	J
•••••	K
•••••	L
•••••	M
•••••	N
•••••	O
•••••	P
•••••	Q
•••••	R
•••••	S
•••••	T
•••••	U
•••••	V
•••••	W
•••••	X
•••••	Y
•••••	Z
•••••	1
•••••	2
•••••	3
•••••	4
•••••	5
•••••	6
•••••	7
•••••	8
•••••	9
•••••	0
•••••	PERIOD
•••••	INTERROGATION
•••••	BREAK (DOUBLE DASH)
•••••	WAIT
•••••	END OF MESSAGE
•••••	END OF TRANSMISSION
•••••	RECEIVED (O.K.)
•••••	INVITATION TO TRANSMIT
•••••	(GO AHEAD)
•••••	EXCLAMATION
•••••	BAR INDICATING FRACTION
•••••	(OBLIQUE STROKE)
•••••	COMMA
•••••	COLON
•••••	SEMICOLON
•••••	QUOTES
•••••	PARENTHESIS

## THE CONTINENTAL CODE

distance characteristics are generally too "spotty" for reliable communication. The result is that only a few amateurs to-day operate in this territory, though it is probable that more attention will be given to its short-distance properties as the 56-mc. band fills up. The band was "hot" from the DX standpoint for a few months during the early summer and fall of 1935 and 1936, however, and this condition may be encountered again in 1937.

The 56,000-kc. or 56-mc. band, made available for amateur experimentation at the request of the League, has for many years been regarded as strictly a local and short-distance band for distances of ten to thirty miles. Because of the cheapness, compactness and ease of construction of the necessary apparatus it has proved ideal for this purpose and many hundreds of stations have operated "locally" there. During the latter part of 1934, however, experiments with directive antennas by the technical staff of the A.R.R.L. indicated the possibility of surprisingly consistent two-way work over distances of a hundred miles or more, with the result that tremendous impetus was given to experimentation at these frequencies and is expected to continue even stronger in future.

Above 110,000 kc. but little progress has as yet been made, since it was only during the summer of 1934 that the A.R.R.L. was able to secure a regulation permitting general amateur work on all the higher frequencies above 110-mc. These frequencies have in the past been generally considered useless for communication over any appreciable distance, just as were the frequencies around 56 mc. But the developments in that region have resulted in creating considerable interest in the still higher frequencies, and during 1937 it is expected that many experimenters will endeavor to exploit them to their utmost for communication purposes.

## Memorizing the Code

● The first job you should tackle is the business of *memorizing* the code. This can be done while you are building your receiver. Thus, by the time the receiver is finished, you will know

# The Radio Amateur's Handbook . . . . .

all the characters for the alphabet, the most-used punctuation marks, and the numerals, and will be ready to practice receiving in order to acquire speed. Speed practice, either by means of a buzzer, or by listening in on your receiver, can be indulged in on odd moments while the transmitter, in turn, is being constructed. The net result of such an organized program should be that by the time the transmitter is finished you will be able to receive the ten words a minute required by the government for your amateur operator license, and can immediately proceed to studying for the "theoretical" part of your license examination without loss of time.

Memorizing the code is no job at all if you simply make up your mind you are going to apply yourself to the job and get it over with as quickly as possible. The complete Continental alphabet, punctuation marks and numerals are shown in the table given here. The alphabet and all the numerals should be learned, but only the first eight of the punctuation marks shown need be memorized by the

as they are printed. Don't think of A as "dot-dash" but think of it as the sound "dit-dah." B, of course, is "dah-dit-dit-dit," C, "dah-dit-dah-dit" and so on.

Don't think about speed yet. Your first job is simply to memorize all the characters and make sure you know them without hesitation. Good practice can be obtained, while building the receiver, if you try to spell out in code the names of the various parts you are working on at the time.

## Acquiring Speed by Buzzer Practice

● When the code is thoroughly memorized, you can start to develop speed in receiving code transmission. The most enjoyable way to do this is to have two people learn the code together and send to each other by means of a buzzer-and-key outfit. One advantage of this system is that it develops sending ability, too, for the person doing the receiving will be quick to criticize uneven or indistinct sending. If possible, it is a good idea to get the aid of an experienced operator for the first few sessions, so that you will know what well-sent characters sound like.

The diagram shows the connections for a buzzer-practice set. When buying the key of this set it is a good idea to get one that will be suitable for use in the transmitter later; this will save you money.

Another good practice set for two people learning the code together is that using an old audio transformer, a type '30 tube, a pair of 'phones, key, two No. 6 dry cells, tube-socket, a 20-ohm filament rheostat, and a 22½-volt B battery. These are hooked up as shown in the diagram to form an audio oscillator. If nothing is heard in the 'phones when the key is depressed, reverse the leads going to the two binding posts at either transformer winding. Reversing both sets of leads will have no effect.

Either the buzzer set or this audio oscillator

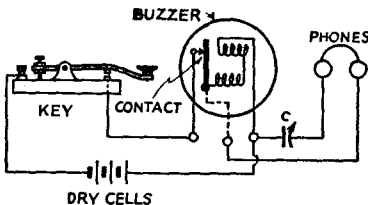

CONNECTIONS OF A BUZZER CODE PRACTICE SET WITH A TELEPHONE HEAD SET

*The intensity of the signal can be varied by changing the setting of the variable condenser. The 'phone and condenser are connected either across the coils of the buzzer or across the vibrator contacts. The condenser may be omitted and the tone may be changed by changing the number of dry cells.*

beginner. Start by memorizing the alphabet, forgetting the numerals and punctuation marks for the present. Various good systems for learning the code have been devised. They are of undoubted value but the job is a very simple one and usually can be accomplished easily by taking the first five letters, memorizing them, then the next five, and so on. As you progress you should review all the letters learned up to that time, of course. When you have memorized the alphabet you can go to the numerals, which will come very quickly since you can see that they follow a definite system. The punctuation marks wind up the schedule — and be sure to learn at least the first eight — the more commonly-used ones.

One suggestion: Learn to think of the letters in terms of *sound* rather than their appearance

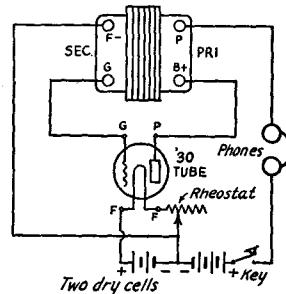

CONNECTING AN AUDIO OSCILLATOR FOR CODE PRACTICE WORK

will give good results. The advantage of the audio oscillator over the buzzer set is that it gives a fine signal in the 'phones without making any noise in the room.

After the practice set has been built, and another operator's help secured, practice sending turn and turn about to each other. Send single letters at first, the listener learning to recognize each character quickly, without hesitation. Following this, start slow sending of complete words and sentences, always trying to have the material sent at just a little faster rate than you can copy easily; this speeds up your mind. Write down each letter you recognize. Do *not* try to write down the dots and dashes; write down the letters. Don't stop to compare the sounds of different letters, or think too long about a letter or word that has been missed. Go right on to the next one or each "miss" will cause you to lose several characters you might otherwise have gotten. If you exercise a little patience you will soon be getting every character, and in a surprisingly short time will be receiving at a good rate of speed. When you think you can receive 13 words a minute (65 letters a minute) have the sender transmit code groups rather than straight English text. This will prevent you from recognizing a word "on the way" and filling it in before you've really listened to the letters themselves.

#### Learning by Listening

● While it is very nice to be able to get the help of another person in sending to you while you are acquiring code-speed, it is not always possible to be so fortunate, and some other method of acquiring speed must be resorted to. Under such circumstances, the time-honored system is to "learn by listening" on your short-wave receiver. Nor should you make the mistake of assuming that this is a more difficult and less-preferred method: it is probable that the *majority* of amateurs acquire their code speed by this method. After building a receiver and getting it in operation, the first step in "learning by listening" will be to hunt for a station sending slowly. With even the simplest short-wave receivers a number of high-power stations can be heard in every part of the world. It is usually possible to pick a station going at about the desired speed for code practice. Listen to see if you cannot recognize some individual letters. Use paper and pencil and write down the letters as you hear them. Try to copy as many letters as you can.

Whenever you hear a letter that you know, write it down. Keep everlastingly at it. *Twenty minutes or half an hour is long enough for one*

*session.* This practice may be repeated several times a day. Don't become discouraged. Soon you will copy without missing so many letters. Then you will begin to get calls, which are repeated several times, and whole words like "and" and "the." After words will come sentences. You now know the code and your speed will improve slowly with practice. Learning by this method may seem harder to some folks than learning with the buzzer. It is the opinion of the writer, who learned in this way, that the practice in copying actual signals and having real difficulties with interference, static, and fading, is far superior to that obtained by routine buzzer practice. Of course the use of a buzzer is of value at first in getting familiar with the alphabet.

In "learning by listening" try to pick stations sending slightly faster than your limit. In writing, try to make the separation between words definite. Try to "read" the whole of short words before starting to write them down. Do the writing while listening to the first part of the next word. Practice and patience will soon make it easy to listen and write at the same time. Good operators usually copy several words "behind" the incoming signals.

A word of caution: the U. S. radio communication laws prescribe heavy penalties for divulging the contents of any radiogram to other than the addressee. You may copy anything you hear for practice but you must preserve its secrecy.

#### Volunteer Code Practice Stations

● Each fall and winter season the A.R.R.L. solicits volunteers, amateurs using code only, or often a combination of voice and code transmission, who will send transmissions especially calculated to assist beginners. These transmissions go on the air at specified hours on certain days of the week and may be picked up within a radius of several hundred miles under favorable conditions. Words and sentences are sent at different speeds and repeated by voice, or checked by mail for correctness if you write the stations making the transmissions and enclose a stamped addressed envelope for reply.

The schedules of the score or more volunteer code-practice stations are listed regularly in *QST* during the fall and winter. Information at other times may be secured by writing Headquarters. Some of the stations have been highly successful in reaching both coasts with code-practice transmissions from the central part of the country.

#### Interpreting What We Hear

● As soon as we finish our receiver and hook it up we shall begin to pick up different high-

# The Radio Amateur's Handbook . . . . .

frequency stations, some of them perhaps in the bands of frequency assigned to amateurs, others perhaps commercial stations belonging to different services. The loudest signals will not necessarily be those from near-by stations. Depending on transmitting conditions which vary with the frequency, the distance and the time of day, remote stations may or may not be louder than relatively near-by stations.



U. S. AMATEUR CALL AREAS

The first letters we identify probably will be the call signals identifying the stations called and the calling stations, if the stations are in the amateur bands. Station calls are assigned by the government, prefixed by a letter (W in the United States, VE in Canada, G in England, etc.) indicating the country. In this country amateur calls will be made up of such combinations as W9GP, W8CMP, W3BZ, W1MK, etc., the number indicating the amateur call area (see map) and giving a general idea of the part of the country in which the station heard is located. The reader is referred to the chapter on "Operating a Station" for complete information on the procedure amateurs use in calling, handling messages, and the like. Many abbreviations are used which will be made clear by reference to the tables of Q Code, miscellaneous abbreviations, and "ham" abbreviations included in the Appendix. The table of international prefixes, also in the back of the book, will help to identify the country where amateur and commercial stations are located.

The commercial stations use a procedure differing in some respects from amateur procedure, and to some extent the procedure of army, naval and government stations is different from this, each service having a modified procedure meeting its own requirements. On the other hand, the International Radiotelegraph Convention has specified certain regulations, abbreviations and procedures which govern all services and insure basic uniformity

of methods and wide understanding between stations of all nations, regardless of services.

"Tape" or "machine" transmission and reception is used to speed up traffic handling to the limit fixed by relays and atmospheric conditions. Most beginners are puzzled by certain abbreviations which are used. Many code groups are sent by different commercial organizations to shorten the messages and to reduce the expense of sending messages which often runs as high as 25 cents a word. Unless one has a code book it is impossible to interpret such messages. Five- and ten-letter cypher groups are quite common and make excellent practice signals. Occasionally, a blur of code will be heard which results when tape is speeded up to 100 words per minute and photographic means are used to record the signals.

## League O.B.S. System

● Official Broadcasting Stations of the A.R.R.L. send the latest Headquarters' information addressed to members *on amateur frequencies*. The messages are often interesting and many of them are sent slowly enough for code practice between 15 and 20 words a minute. Lists and schedules appear from time to time in the membership copies of *QST*.

The very latest *official and special information of general interest*, addressed to A.R.R.L. members, is broadcast twice nightly (except Wednesday and Saturday) simultaneously on two frequency bands from the Headquarters' amateur station, W1MK/W1INF. The schedule for these transmissions is as follows:

Sun.	8:30 p.m. EST — 15 w.p.m. — 3825 and 7150 kes. 10:30 p.m. EST — 25 w.p.m. — 3825 and 7150 kes.
Mon.	8:30 p.m. EST — 20 w.p.m. — 3575 and 7150 kes. 10:30 p.m. EST — 15 w.p.m. — 3575 and 7150 kes.
Tues.	8:30 p.m. EST — 15 w.p.m. — 3575 and 7150 kes. 10:30 p.m. EST — 25 w.p.m. — 3575 and 7150 kes.
Thurs.	8:30 p.m. EST — 15 w.p.m. — 3825 and 7150 kes. 9:30 p.m. EST — 20 w.p.m. — 3825 and 7150 kes. 10:30 p.m. EST — 25 w.p.m. — 3825 and 7150 kes.
Fri.	8:30 p.m. EST — 25 w.p.m. — 3825 and 7150 kes. 10:30 p.m. EST — 15 w.p.m. — 3825 and 7150 kes.

As you can see from this schedule, W1MK sends these bulletins simultaneously on two different frequency bands, so if you are unable to hear the station on the 3500-ke. band you may be able to pick it up on the 7000-ke. band, and *vice versa*.

These transmissions are sent at the indicated rates of speed and are frequently used by advanced beginners for *code practice* work.

## Using a Key

● The correct way to grasp the key is important. The knob of the key should be about eighteen inches from the edge of the operating

## Getting Started

table and about on a line with the operator's right shoulder, allowing room for the elbow to rest on the table. A table about thirty inches in height is best. The spring tension of the key varies with different operators. A fairly heavy spring at the start is desirable. The back adjustment of the key should be changed until there is a vertical movement of about one-sixteenth inch at the knob. After an operator has mastered the use of the hand key the tension should be changed and can be reduced to the minimum spring tension that will cause the key to open immediately when the pressure is released. More spring tension than necessary causes the expenditure of unnecessary energy. The contacts should be spaced by the rear screw on the key only and not by allowing play in the side screws, which are provided merely for aligning the contact points. These side screws should be screwed up to a setting which prevents appreciable side play but not adjusted so tightly that binding is caused. The gap between the contacts should always be at least a thirty-second of an inch, since a too-finely spaced contact will cultivate a nervous style of sending which is highly undesirable. On the other hand too-wide spacing (much over one-sixteenth inch) may result in unduly heavy or "muddy" sending.

Do not hold the key tightly. Let the hand rest lightly on the key. The thumb should be against the left side of the key. The first and second fingers should be bent a little. They should hold the middle and right sides of the knob, respectively. The fingers are partly on top and partly over the side of the knob. The other two fingers should be free of the key. The photograph shows the correct way to hold a key.

A wrist motion should be used in sending. The whole arm should not be used. One should not send "nervously" but with a steady flexing of the wrist. The grasp on the key should be firm, not tight, or jerky sending will result. None of the muscles should be tense but they should all be under control. The arm should rest lightly on the operating table with the wrist held above the table. An up-and-down motion without any sideways action is best. The fingers should never leave the key knob.

### Sending

● Good sending *seems* easier than receiving, but don't be deceived. A beginner shouldn't send fast. Keep your transmitting speed down to the receiving speed, and rather bend your efforts to sending *well*.

When sending do not try to speed things up too soon. A slow, even rate of sending is the

mark of a good operator. Speed will come with time alone. Leave special types of keys alone until you have mastered the knack of properly handling the standard-type telegraph key. Because radio transmissions are seldom free from interference a "heavier" style of sending is best to develop for radio work. A rugged key of heavy construction will help in this.

When signals can be copied "solid" at a rate of 13 words a minute it is time to start practicing with a key in earnest. While learning to receive, you have become fairly familiar with good sending. Try to imitate the machine or tape sending that you have heard. This gives a good example of proper spacing values.

When beginning to handle a key do not try to send more than six or seven words a minute. A dot results from a short depression of the key. A dash comes from the same motion but the contact is held three times as long as when making a dot. A common mistake of beginners is to make it several times too long. There is no great space between the parts of a letter. Particular care should be exercised when sending letters such as *c* to make them "all at once" like this (— — —) and *not* irregularly spaced like this (— — —).

Key practice should not be extended over too long periods at first. The control of the muscles in the wrist and forearm should be developed gradually for best results.

Individuality in sending should be suppressed rather than cultivated. Speed needs to be held in check. "Copiability" is what we want. Repeats waste valuable time. When you find that you are sending too fast for the other fellow, slow down to his speed.

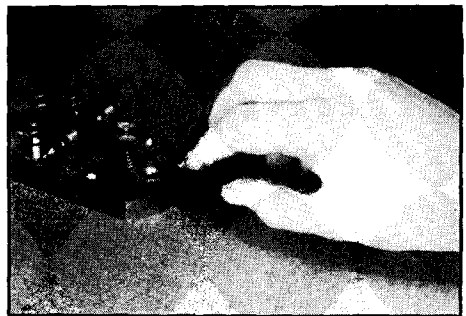

ILLUSTRATING THE CORRECT POSITION OF THE HAND AND FINGERS FOR THE OPERATION OF A TELEGRAPH KEY

A word may be said about automatic and "double-action" keys. These make dots automatically. The rate of making dots is regulated by changing the position of a weight on a

# The Radio Amateur's Handbook . . . . .

swinging armature. Dots are made by pressing a lever to the right. Dashes are made by holding it to the left for the proper interval. A side motion is used in both types of keys.

These keys are useful mainly for operators who have lots of traffic to handle in a short time and for operators who have ruined their sending arm. Such keys are motion savers. However, a great deal of practice is necessary before readable code can be sent. The average novice who uses a "bug" tries to send too fast and ruins his sending altogether. The beginner should keep away from such keys. After he has become very good at handling a regulation telegraph key, he may practice on a "bug" to advantage.

## Obtaining Government Licenses

● When you are able to copy 13 words per minute, have studied basic transmitter theory and familiarized yourself with the radio law and amateur regulations, you are ready to give serious thought to securing the government combination amateur operator-station license which is issued you, after examination, through the Federal Communications Commission, at Washington, D. C.

Because a discussion of license application procedure, license renewal and modification, exemptions, and detailed information on the nature and scope of the license examination involve more detailed treatment than it is possible to give within the limitations of this chapter, it has been made the subject of a special booklet published by the League, and at this point the beginning amateur should possess himself of a copy and settle down to a study of its pages in order to familiarize himself with the intricacies of the law and prepare himself for his test. The booklet, "*The Radio Amateur's License Manual*," may be obtained from A.R.R.L. headquarters for 25¢ postpaid. From the beginner's standpoint one of the most valuable features of this book is its list of nearly 200 representative examination questions with their correct answers.

A few general remarks:

While no government licenses are necessary to operate receivers in the United States, you positively must have the required amateur licenses before doing sending of any kind with a transmitter. This license requirement applies for any kind of transmitter on any wavelength. Attempts to engage in transmitting operation of any kind, without holding licenses, will inevitably lead to arrest, and fine or imprisonment.

Amateur licenses are free, but are issued only to citizens of the United States; this applies both to the station authorization and the

operator's personal license, with the further provision in the station license that it will not be issued where the apparatus is to be located on premises controlled by an alien. But the requirement of citizenship is the only limitation, and amateur licenses are issued without regard to age or physical condition to anyone who successfully completes the required examination. There are licensed amateurs as young as nine and as old as eighty. Many permanently bedridden persons find their amateur radio a priceless boon and have successfully qualified for their "tickets"; even blindness is no bar—several stations heard regularly on the air are operated by people so afflicted.

Persons who would like to operate at amateur stations, but do not have their own station as yet, may obtain an amateur operator license without being obliged to take out a station license. But no one may take out the station license alone; all those wishing station licenses must also take out operator licenses.

Extracts from the basic Communications Act and the complete text of the amateur regulations current at the time this Handbook went to press (October, 1936) will be found in the Appendix. Because the regulations are subject to occasional changes or additions, however, it is recommended that your study of them be from the *License Manual* already mentioned, since this latter publication is always revised, or a "change sheet" incorporated with it, whenever such alterations in our regulations take place.

## Canadian Regulations

● Canadian amateurs wishing operators' licenses must pass an examination before a radio inspector in transmission and reception at a speed of ten words per minute or more. They must also pass a verbal examination in the operation of amateur apparatus of usual types, must have a working knowledge of procedure, and must have a little operating ability prior to taking the examination. Nothing is likely to be asked which is not covered in this *Handbook* or the *License Manual*. The fee for examination as operator is 50 cents and is payable to the Radio Inspector who examines the candidate.

The form for application for station license may be obtained either from a local Radio Inspector's office or direct from the Department of Marine and Fisheries, Radio Branch, Ottawa. The applicant must also sign a declaration of secrecy which, as a matter of fact, is executed at the time of obtaining the operator's license. The annual fee for station licenses for amateur work in Canada is \$2.50.



# 3

## ***Fundamental Electrical Principles***

### **ESSENTIAL ELEMENTS IN ALTERNATING AND DIRECT CURRENT CIRCUITS**

**A**MATEUR radio is a part of the great field of electrical communication, both wire and radio, which has its foundation in the knowledge of electricity that has been in process of development for centuries. Although Marconi's actual radio communication did not come into being until the turn of the present century, its accomplishment resulted directly from the earlier scientific work of Hertz with electro-magnetic waves (in the eighteen-eighties); while this work, in turn, had as its foundation the still earlier contributions of Maxwell (in the eighteen-sixties). And preceding these developments, which we associate more directly with present-day radio, were the discoveries of Faraday and a host of others, extending back to Thales in ancient Greece. The names of many of these builders of our radio structure remain with us to-day in the familiar designations of electrical units and phenomena; the "volt" for Volta, the "am-

pere" for Ampere, the "ohm" for Ohm, the "farad" for Faraday, the "henry" for Henry, and so on.

While it is possible for the practical amateur to set up and operate a station more or less successfully by diving into the game with little or no understanding of these fundamental electrical principles, more certain progress and greater enjoyment follow when the rudiments are familiar to him. Starting without them, one is certain, sooner or later, to be stuck by problems that demand a knowledge of fundamental things for their solution, necessitating turning back to cover the neglected groundwork. Of course a thoroughly complete treatment of these principles in all their aspects would be beyond the possible scope of this book. Hence, our purpose here is to give essential information on those fundamentals which have been shown by experience to be most useful in the practical building and operating of a station.

#### **Abbreviations for Electrical and Radio Terms**

Alternating current	a.c.	Megohm	M $\Omega$
Ampere (amperes)	a.	Meter	m.
Antenna	ant.	Microfarad	$\mu$ fd.
Audio frequency	a.f.	Microhenry	$\mu$ h.
Centimeter	cm.	Micromicrofarad	$\mu\mu$ fd.
Continuous waves	c.w.	Microvolt	$\mu$ v.
Cycles per second	c.p.s.	Microvolt per meter	$\mu$ v/m.
Decibel	db	Microwatt	$\mu$ w.
Direct current	d.c.	Milliampere	ma.
Electromotive force	e.m.f.	Millivolt	mv.
Frequency	f.	Milliwatt	mw.
Ground	gnd.	Modulated continuous waves	m.c.w.
Henry	h.	Ohm	$\Omega$
High frequency	h.f.	Power	P.
Intermediate frequency	i.f.	Power factor	p.f.
Interrupted continuous waves	i.e.w.	Radio frequency	r.f.
Kilocycles (per second)	kc.	Ultra-high frequency	u.h.f.
Kilowatt	kw.	Volt (volts)	v.
Megacycle (per second)	Mc. or mc.	Watt (watts)	w.

For further study the advanced amateur is referred to the selected references given in the Appendix and listed in the "Amateur's Bookshelf" elsewhere in this volume.

## What Is Electricity?

In the not distant past the nature of electricity was considered something beyond understanding but in recent years much of the mystery has been removed. We know now that what we call electricity is the evidence of activity of electrons.

*"Electrons in motion constitute an electric current."*

But what is the electron and what is the source of those that constitute electric current? The accepted theory is that the electron does not ordinarily exist in an isolated state but normally has a sort of family life, in combination with other electrons, in the *atom*. Atoms make up *molecules* which, in turn, make up the substances familiar to us, copper, iron, aluminum, etc. Atoms differ from each other in the number and arrangement of the electrons that constitute them.

The atom has a nucleus which is considered to be composed of both positive and negative electrons, but with the positive predominating so that the nature of the nucleus is positive. For purposes of identification the positive electrons are referred to as *protons* and the negative electrons simply as *electrons*. The electrons and protons of the nucleus are intimately and closely bound together. But exterior to the nucleus are negative electrons which are more or less free agents that can leave home with little urging. Ordinarily the atom is electrically neutral, the outer negative electrons balancing the positive nucleus. It is when something happens to disturb this balance and when the foot-loose electrons begin to leave home that electrical activity becomes evident.

### Electron Flow — Electric Current

● It is considered likely that there is a continuous interchange of electrons between the atoms of a solid body, such as a piece of copper wire, but that the net effect under ordinary conditions is to make the average in any one direction practically negligible. If, however, there is an electric field through the wire, as when the ends are connected to the terminals of a battery, there sets in a consistent drift of the negatively charged electrons, from atom to atom, towards the end of the wire connected to the positive battery terminal, somewhat as shown in Fig. 301. This drift of electrons constitutes an electric current. The rate at which the current flows will be determined by the

characteristics of the conductor, of course, and by the strength of the electric field.

Each electron, and they are all alike irrespective of the kind of atom from which they come, is unbelievably minute and a measure of electric current in terms of number of electrons would be impracticable. Therefore a larger unit is used, the *ampere*.

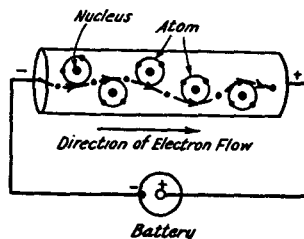

FIG. 301—ILLUSTRATING CURRENT CONDUCTION IN A SOLID SUBSTANCE SUCH AS A COPPER WIRE

*Electrons are relayed from atom to atom, from the negative towards the positive end.*

A current of 1 ampere represents  $10^{19}$  (ten million, million, million) electrons flowing past a point in 1 second; or a micro-ampere (millionth of an ampere) 10 million electrons per micro-second (millionth of second).

### Direction of Flow

● There is one point in connection with current flow which is likely to cause confusion if particular attention is not paid to it. *The drift of electrons along a conductor* (which constitutes a current flow) is always from the negative to the positive terminal. On the other hand, the conventional conception is that of electricity flowing from the positive to the negative terminal. The discrepancy results from the fact that the pioneer electrical experimenters, having no accurate understanding of the nature of electricity, arbitrarily assumed the direction to be from positive to negative. However, just so long as the facts are recognized clearly, no confusion need result.

A helpful practical rule to remember is: *The conventionally "negative" (or "—") terminal of a device, such as a direct-current meter, is always connected to the side of a circuit from which electrons are flowing.* For instance, a d.c. meter connected in the external circuit of the vacuum tube illustrating thermionic emission in Fig. 302, in series with the battery, would have its negative terminal towards the plate and its positive terminal towards the cathode, since the electrons are flowing from the plate back to the cathode in this "return" circuit.

# . . . . . *Fundamental Electrical Principles*

This would be true whether the meter was connected between the positive side of the battery and plate, or between the negative side of the battery and cathode. A voltmeter connected across the battery to measure the supply voltage would have its negative terminal connected to the negative of the battery and its positive terminal to the positive of the battery, since in this case the electron flow through the meter would be from the negative terminal of the battery to its positive, as shown by the illustration of conduction in Fig. 301.

### Conductors and Insulators

● The ease with which electrons are able to be transferred from one atom to another is a measure of the conductivity of the material. When the electrons are able to flow readily, we say that the material is a good *conductor*. If they are not able to chase off to another atom quite so readily, we say that the substance has more *resistance*. Should it be almost impossible for the electrons to break from their normal path around their own nucleus, the material is what we term an *insulator*. Copper, silver and most other metals are relatively good conductors of electricity; while such substances as glass, mica, rubber, dry wood, porcelain and shellac are relatively good insulators.

The resistance of most substances varies with changes in temperature. Sometimes the variation is so great that a body ordinarily considered an insulator becomes a conductor at high temperatures. The resistance of metals usually increases with an increase in temperature while the resistance of liquids and of carbon is decreased with increasing temperature.

### Conduction in Liquids and Gases

● Besides the case of conduction in the solid copper wire, in which there is electron drift from atom to atom but with the individual atoms remaining more or less stationary and each being but momentarily deficient in electron content, there are other forms of conduction important in radio communication. The general case of conduction in liquids is one.

### Ionization

● For instance, take that of conduction in a solution of sodium chloride (common table salt) in water. In such a solution there is a number of *molecules* of salt

that have separated into two parts, one of which has the nucleus of the sodium atom while the other has the nucleus of the chlorine atom. But the two parts are not truly atoms because the chlorine part has one excess electron and is *negative* in character while the sodium part is deficient by one electron and therefore is *positive* in character. No longer true atoms, they are now *ions* and the spontaneous process of *disassociation* in solution is one form of *ionization*. If plates connected to the terminals of a battery are now placed in the solution, the positive sodium ions travel to the negative plate where they acquire negative electrons; and the negative chlorine ions travel to the positive plate where they give up their excess electrons; and both again become neutral atoms. The energy supplied by the battery is used to move the ions through the liquid and to supply or remove electrons. Thus there is a flow of electric current through the liquid by *electrolytic conduction*. This kind of conduction plays a part in the operation of such radio equipment as electrolytic rectifiers.

Another type of conduction important in the operation of radio equipment is that which takes place in gases. This also involves ionization, although here the ionization is not spontaneous as in the electrolytic conduction just described but is produced by rapidly moving free electrons colliding with atoms, and hence, is called *ionization by collision*. Such conduction is illustrated by the ordinary neon lamp. The bulb contains a pair of plates and is filled with neon gas. In addition to the molecules of the gas, there will be a few free electrons. If a battery of sufficient voltage is connected to the two plates, the initial free electrons will make a dive for the positively charged plate, their velocity being accelerated by the electric field. In their headlong dash they collide with neon atoms and knock off outer electrons of these atoms, converting the latter to positive ions. The additional free electrons produced by collision now join the procession, and ionize more atoms. As they are freed, the electrons travel towards the positive plate. In the meantime, the more sluggish positive ions have been traveling towards the negative plate, where they acquire electrons and again become neutral atoms. The net result is a flow of electrons, and hence of current, between the

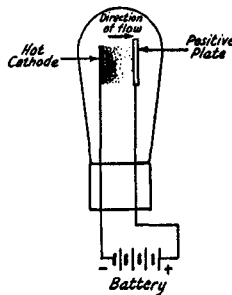

FIG. 302 — ILLUSTRATING CONDUCTION BY THERMIONIC EMISSION OF ELECTRONS IN A VACUUM TUBE

*When the cathode is heated electrons are stimulated to fly off from the cathode surface and are attracted to the positive plate. Clouding of electrons near the cathode constitutes what is known as the space charge.*

electrodes, from negative plate to positive plate. The light given off, it may be mentioned is considered incidental to the recombination of ions and free electrons at the negative plate. This kind of *conduction by ionization* is utilized in the operation of the gaseous rectifiers used in radio power supplies.

## Electron Emission

● Still another form of conduction very important in radio communication is pure *electronic conduction*. In the case of the copper wire we saw that the individual electrons did not make the complete trip from one end of the circuit to the other but that the flow was a sort of relay process. We also saw that the electrons could not leave the wire in random directions but, under the influence of the electric field, progressed only from the negative towards the positive end. They were restrained from leaving the surfaces of the conductor. But they can be made to fly off from the conductor when properly stimulated to do so, as is illustrated by the familiar radio vacuum tube. Here we have electrons being freed from the *cathode*, a conductor that would nominally retain them, and actually traveling through vacuum to the plate that attracts them because it is connected to the positive terminal of a battery, as illustrated in Fig. 302. The reason that the electrons are freed from the cathode is that it has been heated to a temperature that activates them sufficiently to enable them to break away. This is known as *thermionic electron emission*, sometimes called simply *emission*. Once free, most of the emitted electrons make their way to the plate, although some return, repelled from traveling farther by the cloud of negative electrons immediately surrounding the cathode. This electron cloud about the emitting cathode constitutes what is known as the *space charge*. A few electrons that reach the plate may have sufficient velocity to dislodge one or more electrons already on the plate. This dislodging of electrons from the plate by other fast moving electrons constitutes *secondary emission*. When it occurs there is actually simultaneous electron flow in two directions. The various phenomena connected with electronic conduction, briefly outlined here, are of such extreme importance in the operation of vacuum tubes that they cannot be emphasized too greatly.

## Photoelectric Emission

● In addition to the two types of electron emission just described, there is also a third type known as *photoelectric emission*. Such emission occurs when electrons are liberated

from matter under the influence of light rays. While it has little practical application in amateur radio, it is utilized widely in other fields where photo-electric cells or tubes are used. A photoelectric tube contains a cathode of material which liberates electrons readily when exposed to light and an anode (positive plate) which attracts the liberated electrons.

## Electromotive Force (e.m.f.)

Just as soon as electrons are removed from one body and become attached to a second one, there is created a firm desire on the part of the estranged electrons to return to their normal position. For instance, the excess electrons on the negatively charged pole of a battery, attempting to return to the positively charged pole, create an electrical pressure between the two terminals. This pressure is termed *electromotive force* and the unit of measurement, widely used in our radio work, is the *volt*. In the ordinary dry cell (when fresh) the electromotive force between the two terminals is of the order of 1.5 or 1.6 volts. Should we have two such cells, and should we connect the negatively charged terminal of one to the positively charged terminal of the second cell we would then have twice the voltage of one cell between the remaining two free terminals. In this example we have connected the cells in *series* and the combination of the two cells becomes what we know as a *battery*. In the common "B" battery, so widely used with radio receivers, a great many small cells are so connected in series to provide a relatively high electromotive force or voltage between the outer terminals.

Another method of connecting a battery of cells together is to join all the positive terminals and all the negative terminals. The cells are then said to be connected in *parallel*. The voltage between the two sets of terminals will then be just the same as that of a single cell but it will be possible to take a greater amount of current from the battery than would have been possible from the single cell.

In practical work we use meters to measure voltage and current. The *voltmeter* is connected across the points between which the unknown voltage exists while the *ammeter* is connected in series with the conductor in which the current flows. With this arrangement, the ammeter becomes a part of the conductor itself. In both cases, the reading in volts or amperes will be indicated directly on the calibrated scale of the instrument. Such instruments, and measurement methods, are treated in a later chapter.

**Direct and Alternating Current (d.c. and a.c.)**

Of course, all electric currents do not flow continuously in the same direction along a conductor. The currents produced by batteries and by some generators flow in this manner, and therefore are termed *direct currents*. Should the current, for some reason or other, increase and decrease at periodic intervals or should it stop and start frequently it is still a direct current as long as the flow is always in the same direction, though it would be a fluctuating or intermittent one.

The type of current most generally used for the supply of power in our homes does not flow in one direction only, but *reverses* its direction many times each second. The electron drift or flow in a conductor carrying such a current first increases to a maximum, falls to zero, then reverses its direction, again rises to a maximum and again falls to zero — to reverse its direction again and continue the process.

**Frequency (f)**

● In most of the power circuits, the current flows in one direction for 1/120th of a second, reverses, flows in the opposite direction for another 1/120th of a second and so on. In other words, the complete *cycle* of reversal occupies 1/60th of a second. The number of complete cycles of flow in one second is termed the *frequency* of the current. In the instance under discussion we would say that the frequency is 60 cycles per second. All currents which reverse their direction in this manner are known as *alternating currents*. We are to find that they are not by any means limited to the circuits which supply power to our homes. Telephone and radio circuits, for instance, are virtually riddled with alternating currents having a wide variety of frequencies. The currents which are produced by the voice in a telephone line may have frequencies between about 100 and 5,000 cycles per second while the alternating currents which we are to handle in the circuits of a radio transmitter may have a frequency as high as 60 million cycles per second. Because of the high frequencies used in radio work the practice of speaking in terms of cycles per second is an awkward one. It is customary, instead, to use *kilocycles per second* or, simply, *kilocycles* (kc.) — the kilocycle being one thousand cycles. Yet another widely used term is the *megacycle* (mc.) — a million cycles.

Alternating current, unlike direct current, cannot be generated by batteries. For the supply of commercial power it is almost always produced by rotating machines driven by

steam turbines. In radio work we make use of this current for the power supply of our radio apparatus, while the very high frequency alternating currents in the radio transmitter are produced by vacuum tubes connected in appropriate circuits.

**Resistance (R)**

Now that we have some conception of what an electric current really is and of the different forms in which electricity is to be found, we

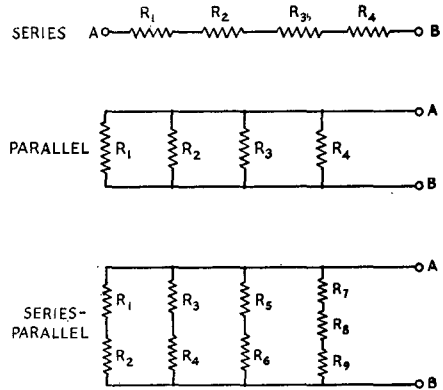

FIG. 303 — DIAGRAMS OF SERIES, PARALLEL AND SERIES-PARALLEL RESISTANCE CONNECTIONS

may proceed to examine its effects in the apparatus which is to be used in radio work.

We have already mentioned that any substance in which an electric current can flow is a conductor and we have also pointed out that some substances conduct more readily than others — they have less resistance. Most of the conductors in radio apparatus — such as wiring, coils, etc. — are required to have the greatest conductivity or the least resistance possible. They are of metal, usually copper. But many of the conductors are actually placed in the circuit to offer some definite amount of resistance. They are known under the general term of *resistors* and the amount of resistance they (or any conductor) offer is measured in *ohms*.

**Ohm's Law**

● When a current flows in any electric circuit, the magnitude of the current is determined by the electromotive force in the circuit and the resistance of the circuit, the resistance being dependent on the material, cross-section and length of the conductor. The relations which determine just what current flows are known as *Ohm's Law*. It is an utterly simple law but

# The Radio Amateur's Handbook . . . . .

one of such great value that it should be studied with particular care. With its formula, carrying terms for current, electromotive force and resistance, we are able to find the actual conditions in many circuits, providing two of the three quantities are known. When  $I$  is the current in amperes,  $E$  is the electromotive force in volts and  $R$  is the circuit resistance in ohms, the formulas of Ohm's Law are:

$$R = \frac{E}{I} \quad I = \frac{E}{R} \quad E = IR$$

The *resistance* of the circuit can therefore be found by *dividing the voltage by the current*; the *current* can be found by *dividing the voltage by the resistance*; the *electromotive force or e.m.f.* is equal to the *product of the resistance and the current*. At a later stage it will be shown just how valuable may be the practical application of this law to the ordinary problems of our radio work.

## Resistors

● The resistors used in electrical circuits to introduce a known amount of resistance are made up in a variety of forms. One common type consists of wire, of some high resistance metal, wound on a porcelain former. To obtain very high values of resistance the wire must be extremely fine. Because this introduces manufacturing difficulties, some of the high value resistors which are not required to carry heavy current are made up of some carbon compound or similar high resistance material.

### Series and Parallel Connections

● Resistors, like cells, may be connected in series, in parallel or in series-parallel. When two or more resistors are connected in series, the total resistance of the group is higher than that of any of the units. Should two or more resistors be connected in parallel, the total resistance is decreased. Fig. 303 and the following formulas show how the value of a bank of resistors in series, parallel or series-parallel may be computed, the total being between  $A$  and  $B$  in each case.

Resistances in series:

$$\text{Total resistance in ohms} = R_1 + R_2 + R_3 + R_4$$

Resistances in parallel:

$$\text{Total resistance in ohms} = \frac{1}{\frac{1}{R_1} + \frac{1}{R_2} + \frac{1}{R_3} + \frac{1}{R_4}}$$

Or, in the case of only 2 resistances in parallel,

$$\text{Total resistance in ohms} = \frac{R_1 R_2}{R_1 + R_2}$$

Resistances in series-parallel:

$$\text{Total resistance in ohms} = \frac{1}{\frac{1}{R_1 + R_2} + \frac{1}{R_3 + R_4} + \frac{1}{R_5 + R_6} + \frac{1}{R_7 + R_8 + R_9}}$$

## Quantity, Energy and Power Units

In addition to the volt (unit of pressure), ampere (unit of flow) and ohm (unit of resistance), there are three other electrical units which are to be distinguished. These are the *coulomb*, the unit of quantity (Q); the *joule*, the unit of work or energy (W); and the *watt*, the unit of power or rate of work (P).

One coulomb is the quantity of electricity represented by a current flow of 1 ampere for 1 second. In other words, 1 coulomb equals 1 ampere-second.

One joule represents the work done in moving 1 coulomb against an electrical pressure of 1 volt.

In other words, it is a current flow of 1 ampere for 1 second between two points having a potential difference of 1 volt.

Power is the rate at which work is done. Hence, one watt is equal to 1 joule per second.

In other words, it is the rate of work done when 1 ampere flows between two points having a potential difference of 1 volt. Therefore, power in watts equals volts multiplied by amperes.

### Heating Effect and Power (P)

● The heating effect of the electric current is due to molecular friction in the wire caused by the flow of electricity through it. This effect depends on the resistance of the wire; for a given time (seconds) and current (amperes) the heat generated will be proportional to the resistance through which the current flows. The power used in heating or the heat dissipated in the circuit (which may be considered sometimes as an undesired power loss) can be determined by substitution in the following equations:

Since  $P = EI$

and  $E = IR$

Therefore,  $P = IR \times I = I^2 R$

Also, since  $I = \frac{E}{R}$

$$P = \frac{E^2}{R^2} \times R = \frac{E^2}{R}$$

$P$  being the power in watts,  $E$  the e.m.f. in volts, and  $I$  the current in amperes.

It will be noted that if the current in a resistor and the resistance value are known, we can readily find the power. Or if the voltage

# • • • • • *Fundamental Electrical Principles*

across a resistance and the current through it are known or measured by a suitable voltmeter and ammeter, the product of volts and amperes will give the power. Knowing the approximate value of a resistor (ohms) and the applied voltage across it, the power dissipated is given by the last formula.

Likewise, when the power and resistance in a circuit are known, the voltage and current can be calculated by the following equations derived from the power formulas given above:

$$E = \sqrt{PR}$$
$$I = \sqrt{\frac{P}{R}}$$

Just as we can measure power dissipation in a resistance, we can determine the plate power input to a vacuum-tube transmitter, oscillator or amplifier, by the product of the measured plate voltage and plate current. Since the plate current is usually measured in *milliamperes* (thousandths of amperes), it is necessary to divide the product of plate volts and milliamperes by 1000 to give the result directly in watts.

## **Alternating Current Flow**

In all of these examples we have been assuming that direct currents are being considered. When we impress an alternating voltage on circuits such as those discussed we will cause an alternating current to flow, but this current may not be of the same value as it would be with direct current. In many instances, such as that of a vacuum tube filament connected to a source of alternating current by short wires, the behavior of the circuit would follow Ohm's Law as it has been given and if alternating current meters were used to read the current and voltage we could compute the resistance of the circuit with sufficient accuracy for all ordinary practical purposes. Should there be a coil of wire in the circuit, however, or any electrical apparatus which is not a pure resistance, it would not necessarily be possible to apply our simple formula with satisfactory results. An explanation of the reason for this involves an understanding of the characteristics of other electrical apparatus, particularly of coils and condensers, which have very important parts to play in all radio circuits.

## **Electromagnetism**

When any electric current is passed through a conductor, magnetic effects are produced. Moving electrons produce magnetic fields. Little is known of the exact nature of the forces

which come into play but it is assumed that they are in the form of lines surrounding the wire; they are termed lines of magnetic force. It is known that these lines of force, in the form of concentric circles around the conductor, lie in planes at right angles to the axis of the conductor.

The magnetic field constituted by these lines of force exists only when current is flowing through the wire. When the current is started through the wire, we may think of the magnetic field as coming into being and sweeping outward from the axis of the wire. And on the cessation of the current flow, the field collapses toward the wire again and disappears. Thus energy is alternately stored in the field and returned to the wire. When a conductor is wound into the form of a coil of many turns, the magnetic field becomes stronger because there are more lines of force. The force is expressed in terms of magneto-motive force (m.m.f.) which depends on the number of turns of wire, the size of the coil and the amount of current flowing through it. The same magnetizing effect can be secured with a great many turns and a weak current or with fewer turns and a greater current. If ten amperes flow in one turn of wire, the magnetizing effect is 10 *ampere-turns*. Should one ampere flow in ten turns of wire, the magnetizing effect is also 10 *ampere-turns*.

The length of the magnetic circuit, the material of which it is made and the cross-sectional area, determine what *magnetic flux* ( $\Phi$ ) will be present. And just as the resistance of the wire determines what current will flow in the electric circuit, the *reluctance* ( $\mu$ ) of the magnetic circuit (depending on length, area and material) acts similarly in the magnetic circuit.

$$I = \frac{E}{R} \text{ in the electric circuit; so}$$

$$\Phi = \frac{m.m.f.}{\mu} \text{ in the magnetic circuit.}$$

The magnetic field about wires and coils may be traced with a compass needle or by sprinkling iron filings on a sheet of paper held above the coil through which current is passing. When there is an iron core the increased magnetic force and the concentration of the field about the iron are readily discernible.

*Permeability* is the ratio between the flux density produced in a material by a certain m.m.f. and the flux density that the same m.m.f. will produce in air. Iron and nickel have higher permeability than air. Iron has a permeability some 3000 times that of air, is of low cost, and is therefore very commonly used in magnetic circuits of electrical devices. The permeability of iron varies somewhat depend-

ing on the treatment it receives during manufacture. Soft iron has low *reluctivity*, another way of saying that its permeability is extremely high. The molecules of soft iron are readily turned end to end by bringing a current-carrying wire or a permanent magnet near. When the influence is removed they just as quickly resume their former positions.

When current flows around a soft iron bar we have a *magnet*. When the circuit is broken so the current cannot flow, the molecules again assume their hit-or-miss positions. Little or no magnetic effect remains. When a steel bar is subjected to the same magneto-motive force in the same way, it has less magnetic effect. However, when the current is removed, the molecules tend to hold their end-to-end positions and we have produced a *permanent magnet*. Compass needles are made in this way. Permanent magnets lose their magnetism only when subjected to a reversed m.m.f., when heated very hot or when jarred violently.

## Inductance (L)

● The thought to be kept constantly in mind is that whenever a current passes through a coil it sets up a magnetic field around the coil; that the strength of the field varies as the current varies; and that the direction of the field is reversed if the direction of current flow is reversed. It is of interest now to find that the converse holds true — that if a magnetic field passes through a coil, an electro-motive force is *induced* in the coil; that if the applied field varies, the induced voltage varies; and that if the direction of the field is reversed, the direction of the current produced by the induced voltage is reversed. This phenomenon provides us with an explanation of many electrical effects. It serves in the present instance to give us some understanding of that valuable property of coils — *self-inductance*. Should we pass an alternating current through a coil of many turns of wire, the field around the coil will increase and decrease, first in one direction and then in the other direction. The varying field around the coil, however, will induce a varying e.m.f. in the coil and the current produced by this induced e.m.f. will always be in the opposite direction to that of the current originally passed through the wire. The result, therefore, is that because of its property of self-induction, the coil tends constantly to prevent any change in the current flowing through it and hence to limit the amount of alternating current flowing. The effect can be considered as electrical inertia.

The unit of self-inductance is the *henry*. A coil has a self-inductance of 1 henry when a

rate of current change of 1 ampere per second causes an induced voltage of 1 volt. This basic unit is generally used with iron-core coils (as in power-supply filter circuits), but is too large for convenience in many radio applications. Therefore, smaller units are also used. These are the *millihenry* (*mh*), equal to one-thousandth henry; and the *microhenry* ( $\mu h$ ), one-millionth henry. The practical formula for computing the inductance of radio coils is given in the Appendix, while data for iron-core coils are given in Chapter Fifteen. Stated generally, *the self-inductance of a coil is inversely proportional to the reluctance of its magnetic circuit and is proportional to the square of the number of turns*. If the magnetic circuit is a closed iron core, for instance, the inductance value might be several thousand times what it would be for the same coil without the iron core, the reluctance being that much less than with an air-core. Also, doubling the number of turns would make the inductance 4 times as great. ✕

## Inductances in Series and in Parallel

● Coils may be connected in series, in parallel, or in series-parallel. If connected in series, the total inductance is increased just as the total resistance is increased with resistances in series, *provided the magnetic flux of either coil does not link with the turns of the other*. With the same restriction, the total inductance of coils connected in parallel is reduced just as the total resistance is reduced with resistors connected in parallel. Correspondingly, coils may be connected in series-parallel combinations. The equations for inductances in series, in parallel and in series-parallel are the same as those given for resistances, with the proper inductance values substituted for resistance values.

## Transformer Action

● We have seen that if a magnetic field passes through a coil, an electromotive force is induced in the coil. Not only does this phenomenon provide us with an explanation of self-inductance in coils but it also permits an understanding of how transformers operate. Transformers are very widely used in radio work. In many applications their essential purpose is to convert an alternating current supply of one voltage to one of higher or lower voltage. In transmitters, for instance, there will be one or more transformers serving to step down the 110-volt supply voltage to 2.5, 6.3, 7.5 or 10 volts for the filaments of the transmitting tubes. Then there will be another transformer to step up the 110-volt supply to 500, 1000 or



## . . . . . *Fundamental Electrical Principles*

perhaps several thousand volts for the plate supply of the transmitting tubes. These transformers will consist of windings on a *core* of thin iron laminations. The 110-volt supply will flow through a primary winding and the magnetic field created by this current flow, because it is common to all windings on the core, will induce voltages in all the windings. Should one of the secondary windings have twice the number of turns on the primary winding, the secondary voltage developed will be approximately twice that of the primary voltage. Should one of the secondary windings have one third of the primary turns, the voltage developed across the secondary will be one third the primary voltage. Direct current flowing in the primary of such a transformer would build up a magnetic field as the current started to flow but the field would be a fixed one. So long as the primary current remained steady there would be no voltages developed in the secondaries. This is the reason why transformers cannot be operated from a source of continuous direct current.

Of course all transformers used in radio circuits are not of the iron-core type. Many air-core transformers are employed; and, in more recent times, cores having powdered iron molded in insulating materials also have come into use. More concerning such coils for radio frequencies will be found in the following chapters.

### Magnetic Energy Storage (W)

● The above-mentioned tendency of coils to prevent change in current flow gives them the ability to store energy. This energy storage is proportional to the inductance of the coil and to the square of the current.

$$\text{Energy stored in coil} = \frac{LI^2}{2}$$

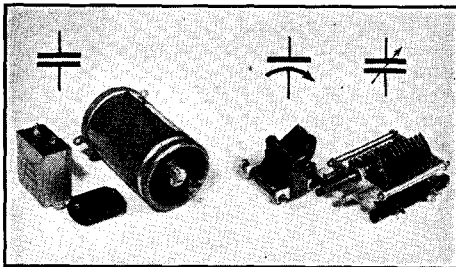

FIG. 304 — TYPES OF FIXED CONDENSERS (LEFT) AND VARIABLE CONDENSERS (RIGHT) WHICH ARE USED IN RADIO CIRCUITS

*The schematic symbols are drawn in above the respective groups. Note that two alternative symbols are shown for variable condensers, the curved-arrow indicating the rotor plates in the one at the left.*

where the energy is in joules or watt seconds.  $L$  is the inductance in henrys,  $I$  is the current in amperes.

This property is of particular importance in the filter systems used for transmitter and receiver power supply which are described in a later chapter.

### Inductive Reactance ( $X_L$ )

● As we have learned, a coil tends to limit the amount of current which an alternating voltage can send through it. A further very important fact is that a given coil with a fixed amount of inductance will retard the flow of a high frequency alternating current much more than a low frequency current. We know, then, that the characteristic of a coil in retarding an alternating current flow depends both on the inductance of the coil and on the frequency of the current. This combined effect of frequency and inductance in coils is termed *reactance*, or *inductive reactance*.

The inductive reactance formula is:

$$X_L = 2\pi fL$$

where:  $X_L$  is the inductive reactance in ohms

$\pi$  is 3.1416

$f$  is the frequency in cycles per second

$L$  is the inductance in henrys

From this it is evident that inductive reactance is directly proportional to frequency and also directly proportional to the value of inductance.

### *The Condenser or Capacitor*

● In radio circuits condensers play just as important a part as coils. Condensers and coils, in fact, are almost always used together. The condenser consists essentially of two or more metal plates separated by a thin layer of some insulating medium from a second similar plate or set of plates. The insulating medium between the metal elements of the condenser is termed the *dielectric*. Unvarying direct current cannot flow through a condenser because of the insulation between the plates. But a steady voltage applied to the terminals of such a condenser will cause it to become charged. The effect, to return to a discussion of electrons, is simply that one element of the condenser is provided with an excess of electrons — thus becoming negatively charged — while the other plate suffers a deficiency of electrons and is therefore positively charged. Should the charging voltage be removed and the two elements of the condenser be joined with a conductor, a flow of electrons would take place from the negative to the positive plate. In other words, a current would flow.

## Capacity or Capacitance (C)

● The characteristic which permits a condenser to be charged in this manner is termed *capacity* or *capacitance*. The capacity of a condenser depends on the number of plates in each element, the area of the plates, the distance by which they are separated by the dielectric and the nature of the dielectric. Glass or mica as the dielectric in a condenser would give a greater capacity than air — other things being equal. The *dielectric constants* for different materials and the formula used for computing the capacity of condensers are to be found in the Appendix.

The unity of capacity is the *farad*. A condenser of one farad, however, would be so large that its construction would be impractical. A more common term in practical work is the *microfarad* (abbreviated  $\mu\text{fd.}$ ) while another (used particularly for the small condensers in high-frequency apparatus) is the *micromicrofarad* (abbreviated  $\mu\mu\text{fd.}$ ). The  $\mu\text{fd.}$  is one millionth of a farad; the  $\mu\mu\text{fd.}$  is one millionth of a microfarad.

## Types of Condensers

● A considerable variety of types of condensers is used in radio work. Perhaps the most commonly known type is the variable condenser — a unit comprising two sets of metal plates, one capable of being rotated and the other fixed and with the two groups of plates interleaving. In this case, the dielectric is almost invariably air. Fixed condensers are also widely used. One type consists of two sets of metal foil plates separated by thin sheets of mica, the whole unit being enclosed in molded bakelite. Yet another type — usually of high capacity — consists of two or more long strips of metal foil separated by thin waxed paper, the whole thing being rolled into compact form and enclosed in a metal can. Paper impregnated with oil or Pyranol is used as the dielectric in compact high-voltage units. Units of this type have capacities of from a fraction of a microfarad to four microfarads or more, and voltage ratings ranging from several hundred to several thousand volts.

Still another type is the electrolytic condenser, widely used in filters of low-power transmitter plate supplies and in receivers. One plate of these condensers consists of sheets of aluminum or aluminum alloy on which a thin insulating film of aluminum oxide is formed by polarization; that is, by connecting this plate to the positive of a d.c. supply. This electrode is immersed in a liquid electrolyte in a "wet" type condenser, the electrolyte

actually serving as the other "plate", to which a conductive connection is made by a second aluminum electrode immersed in the electrolyte. The latter electrode is negative. The electrolyte is usually a solution of borax and boric acid. The "dry" type electrolytic condenser is similar but has its electrolyte soaked into a strip of gauze separating the filmed and non-filmed electrodes. In both types the thin film is the dielectric which, together with the relatively large plate area achieved by the various methods of construction, gives the electrolytic condenser a very high capacitance in small space. But there is one important difference between electrolytic condensers and the other fixed condensers previously described. *The plate on which the film is formed always must be maintained at a positive potential with respect to the other electrode.* Hence, these condensers can be used only with d.c. or pulsating d.c. voltage applied. Unlike other types of fixed condensers, *they cannot be used in circuits carrying only alternating current.* They are ordinarily used in capacitances ranging from 5 to 16 microfarads per unit, although a few types have capacitance of 100  $\mu\text{fd.}$  or more, and have voltage ratings of 25 to 500 volts or slightly higher.

The various types of condensers are usually designated by their dielectric material, or some distinguishing component of the dielectric. Hence, an air-dielectric type is called an "air" condenser, one having paper impregnated with Pyranol is called a "Pyranol" condenser, and so on.

## Capacitive Reactance ( $X_C$ )

● We can readily understand how very different will be the performance of any condenser when direct or alternating voltages are applied to it. The direct voltages will cause a sudden charging current, but that is all. The alternating voltages will result in the condenser becoming charged first in one direction and then the other — this rapidly changing charging current actually being the equivalent of an alternating current through the condenser. Many of the condensers in radio circuits are used just because of this effect. They serve to allow an alternating current to flow through some portion of the circuit but at the same time prevent the flow of any direct current.

Of course, condensers do not permit alternating currents to flow through them with perfect ease. They impede an alternating current just as an inductance does. The term *capacitive reactance* is used to describe this effect in the case of condensers. Condensers have a reactance which is *inversely* proportional to the

# . . . . . Fundamental Electrical Principles

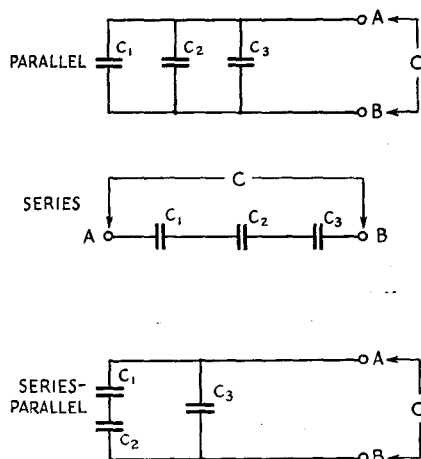

**FIG. 305—DIAGRAMS OF SERIES, PARALLEL AND SERIES-PARALLEL CAPACITANCE CONNECTIONS**

capacitance and to the frequency of the applied voltage. The formula for capacitive reactance is

$$X_C = \frac{1}{2\pi f C_{fd}}$$

where  $X_C$  is the capacitive reactance in ohms  
 $\pi$  is 3.1416

$f$  is the frequency in cycles per second

$C_{fd}$  is the condenser capacitance in farads.

Where the capacitance is in microfarads ( $\mu\text{fd.}$ ), as it is in most practical cases, the formula becomes

$$X_C = \frac{10^6}{2\pi f C_{\mu\text{fd.}}}$$

$10^6$  being 1,000,000.

### Condensers in Series and Parallel

● Capacitances can be connected in series or in parallel like resistances or inductances, as shown in Fig. 305. However, connecting condensers in parallel makes the total capacitance *greater* while in the case of resistance and inductance, the value is lessened by making a parallel connection.

The equivalent capacity of condensers connected in parallel is the sum of the capacities of the several condensers so connected:

$$C = C_1 + C_2 + C_3$$

The equivalent capacity of condensers connected in series is expressed by the following formula:

$$\frac{1}{C} = \frac{1}{C_1} + \frac{1}{C_2} + \frac{1}{C_3}$$

When but two condensers are connected in series, the following expression can be used

$$C = \frac{C_1 C_2}{C_1 + C_2}$$

Where the net capacitance of a series-parallel combination is to be found, the capacitance of the series groups can be worked out separately and then added in parallel combination. As is also true in the case of resistances in parallel, the Series-Parallel type "Lightning" Calculator is a useful aid in making such determinations.

Connecting condensers in series increases the breakdown voltage of the combination although, of course, it decreases the capacity available. Condensers of identical capacitance are most effectively connected in series for this purpose. Voltage tends to divide across series condensers in inverse proportion to the capacity, so that the smaller of two series condensers will break down first if the condensers are of equal voltage rating. Before selecting filter condensers the operating conditions, voltage peaks and r.m.s. values should be carefully considered. For complete information on this matter the chapter on Power Supply should be consulted.

### Energy Stored in Condensers (W)

● As has been previously shown, magnetic energy is stored in coils. Likewise, energy is stored in condensers. But where the amount of energy was associated with current value in the case of the coil, it is associated with e.m.f. in the instance of the condenser. Hence, it is termed *electrostatic* energy. The amount of energy stored by a condenser is given by this equation:

$$\text{Energy stored in condenser} = \frac{CE^2}{2},$$

where the energy is in joules (or watt-seconds),  $C$  is the capacitance in farads, and  $E$  is the e.m.f. in volts. When the capacitance is in microfarads, as is usual in practical cases, the equation is

$$\text{Energy stored} = \frac{C_{\mu\text{fd.}} E^2}{2 \times 10^6},$$

$10^6$  being 1,000,000 and the answer being in joules.

This energy storage relation for condensers, like the energy storage relation for coils, is of importance in filter circuits.

### Resistance-Capacitance Time Constant (RC)

● If a charged condenser had infinite resistance between its plates, it would hold the charge indefinitely at its initial value. However,

# The Radio Amateur's Handbook . . . . .

since all practical condensers do have more or less definite resistance (through the dielectric and between the connecting terminals), the charge gradually leaks off. Good condensers have a very high "leakage resistance," however, and will hold a charge for days if left undisturbed.

In a circuit containing only capacitance and resistance, the time required for the potential difference between the charged plates of a condenser to fall to a definite percentage of its initial value is determined by the capacitance of the condenser and the value of the resistance. The relation is of practical importance in many circuit applications in amateur transmission and reception, as in time delay with automatic volume control, resistance-capacitance filters, etc. For the voltage to fall to 37% (0.37) of its initial value,

$$t = RC,$$

where  $t$  is the time in *microseconds* (millionths of a second),  $R$  is the resistance in ohms, and  $C$  is the capacitance in microfarads.  $RC$  should be divided by 1 million to give the answer in seconds. This is called the *time constant* of the combination. The time required for the voltage to fall to one-tenth (10%) of its initial value can be found by multiplying  $RC$ , as given above, by 2.4.

Time constant,  $t$ , for 90% fall in voltage

$$= 2.4 \frac{RC}{10^6}, t \text{ being in seconds, } R \text{ in ohms and } C \text{ in } \mu fd.$$

### Distributed Inductance, Capacity and Resistance

● So far we have considered three very important properties of electrical circuits and apparatus: Resistance, inductance and capacity. Resistors, coils and condensers usually are all built to have as much as possible of one of these properties with as little as possible of the other two. These "lumped" properties can then be utilized in a circuit to produce the required effect on the current and voltage distribution. In every sort of coil and condenser, however, we find not just the one property for which the instrument is used but a combination of all the electrical properties we have mentioned. And for this reason most design work is somewhat of a compromise. Every coil and transformer winding has resistance and distributed capacity between the turns in addition to the inductance that makes it a useful device. Then, every condenser has some resistance and more or less inductance. Resistors, as another example, quite often have appreciable inductance and distributed capacity.

### Impedance (Z)

● We start to realize the importance of these characteristics just as soon as we endeavor to apply Ohm's Law to circuits in which alternating current flows. If inductances did not have any resistance we could assume that the current through the coil would be equal to the voltage divided by the reactance. But the coil will have resistance, and this resistance will act with the reactance in limiting the current flow. The combined effect of the resistance and reactance is termed *impedance* in the case of both coils and condensers. The symbol for impedance is  $Z$  and it is computed from this formula:

$$Z = \sqrt{R^2 + X^2}$$

where  $R$  is the resistance of the coil and where  $X$  is the reactance of the coil. The terms  $Z$ ,  $R$  and  $X$  are all expressed in ohms. Ohm's Law for alternating current circuits then becomes

$$I = \frac{E}{Z} \quad Z = \frac{E}{I} \quad E = IZ$$

When a circuit contains resistance, capacitance and inductance, all three in series, the value of reactance will be the difference between that of the coil and that of the condenser. Since for a given coil and condenser the inductive reactance increases with frequency and capacitive reactance decreases with frequency,  $X_L$  is conventionally considered positive and  $X_C$  negative.

In finding the current flow through a condenser in an alternating current circuit we can usually assume that  $I = \frac{E}{\sqrt{X_C}}$  ( $X_C$  being the capacitive reactance of the condenser). The use of the term  $Z$  (impedance) is, in such cases, made unnecessary because the resistance of the usual good condenser is not high enough to warrant consideration. When there is a resistance in series with the condenser, however, it can be taken into account in exactly the same

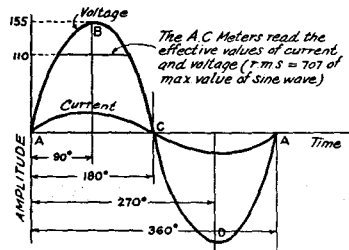

FIG. 306 — REPRESENTING SINE-WAVE ALTERNATING VOLTAGE AND CURRENT

# . . . . . *Fundamental Electrical Principles*

manner as was the resistance of the coil in the example just given. The impedance of the condenser-resistance combination is then computed and used as the  $Z$  term in the Ohm's Law formulas.

### The Sine Wave

In Fig. 306 a curve describing the voltage developed by an alternating-current generator during one complete cycle is shown. This curve is actually a graph of the instantaneous values of the voltage amplitude, plotted against time, assuming a theoretically perfect generator. It is known as a *sine curve*, since it represents the equation

$$e = E_{\max} \sin \omega t,$$

where  $e$  is the instantaneous voltage,  $E_{\max}$  is the maximum voltage and  $t$  is the time from the beginning of the cycle. The term  $\omega$ , or  $2\pi f$ , represents the *angular velocity*, there being  $2\pi$  radians in each complete cycle and  $f$  cycles per second. All the formulas given for alternating current circuits have been derived with the assumption that any alternating voltage under consideration would follow such a curve.

It is evident that both the voltage and current are swinging continuously between their positive maximum and negative maximum values, and it might be wondered how one can speak of so many amperes of alternating current when the value is changing continuously. The problem is simplified in practical work by considering that an alternating current has an effective value of one ampere when it produces heat at the same average rate as one ampere of continuous direct current flowing through a given resistor. This effective value is the square root of the mean value of the instantaneous current squared. For the sine-wave form,

$$E_{\text{eff}} = \sqrt{\frac{1}{2} E_{\max}^2}.$$

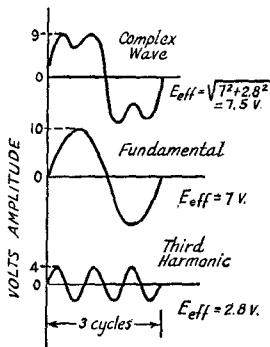

FIG. 307 — A COMPLEX WAVE AND ITS SINE-WAVE COMPONENTS

For this reason, the effective value of an alternating current, or voltage, is also known as the *root-mean-square* or *r.m.s.* value. Hence, the effective value is the square root of  $\frac{1}{2}$  or 0.707 of the maximum value — practically considered, 70% of the maximum value.

Another important value, involved where alternating current is rectified to direct current, is the *average*. This is equal to 0.636 of the maximum (or peak) value of either current or voltage. The three terms *maximum* (or *peak*), *effective* (or *r.m.s.*) and *average* are so important and are encountered so frequently in radio work that they should be fixed firmly in mind right at the start.

They are related to each other as follows:

$$\begin{aligned} E_{\max} &= E_{\text{eff}} \times 1.414 = E_{\text{ave}} \times 1.57 \\ E_{\text{eff}} &= E_{\max} \times .707 = E_{\text{ave}} \times 1.11 \\ E_{\text{ave}} &= E_{\max} \times .606 = E_{\text{eff}} \times .9 \end{aligned}$$

The relationships for current are the same as those given above for voltage. The usual alternating current ammeter or voltmeter gives a direct reading of the effective or r.m.s. (root mean square) value of current or voltage. A direct current ammeter in the plate circuit of a vacuum tube approximates the average value of rectified plate current. Maximum values can be measured by a peak vacuum-tube voltmeter. Instruments for making such measurements are treated in Chapter Seventeen.

### Complex Waves

● Alternating currents having the ideal sine-wave form just described are practically never found in actual radio circuits, although waves closely approximating the perfectly sinusoidal can be generated with laboratory-type equipment. Even the current in power mains is somewhat non-sinusoidal, although it can be considered sinusoidal for most practical purposes. In the usual case, such a current actually has components of two or more frequencies integrally related, as shown in Fig. 307. The lowest and principal frequency is the *fundamental*. The additional frequencies are whole-number multiples of the fundamental frequency (twice, three times, etc.), and are called *harmonics*. One of double frequency is the second harmonic, one of triple frequency the third harmonic, etc. Although the wave resulting from the combination is non-sinusoidal the wave-form of each component taken separately has the sine-wave form.

The effective value of the current or voltage for such a complex wave will not be the same as for a pure sine wave of the same maximum value. Instead, *the effective value for the complex wave will be equal to the square root of the*

# The Radio Amateur's Handbook . . . . .

sum of the squares of the effective values of the individual frequency components. That is,

$$E = \sqrt{E_1^2 + E_2^2 + E_3^2},$$

where  $E$  is the effective value for the complex wave, and  $E_1, E_2$ , etc., are the effective values

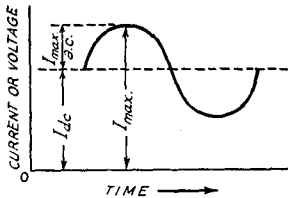

FIG. 308 — PULSATING CURRENT COMPOSED OF ALTERNATING CURRENT SUPERIMPOSED ON DIRECT CURRENT

of the fundamental and harmonics. The same relation also applies where currents of different frequencies not harmonically related flow in the same circuit. Further aspects of complex waves are discussed in connection with distortion in the following chapter. The subject is of particular importance in phone transmission, as shown in Chapters Eleven and Twelve.

### Combined A.C. and D.C.

● There are many practical instances of simultaneous flow of alternating and direct current in a circuit. When this occurs there is a *pulsating* current and it is said that an alternating current is *superimposed* on a direct current. As shown in Fig. 308, the maximum value is equal to the d.c. value plus the a.c. maximum, while the minimum value (on the negative a.c. cycle) is the difference between the d.c. and the maximum a.c. values. If a d.c. ammeter is used to measure the current, only the average or direct-current component will be indicated. An a.c. meter, however, will show the effective value of the combination. But this effective value is *not* the simple arithmetical sum of the effective value of the a.c. and the d.c., *but is equal to the square root of the sum of the effective a.c. squared and the d.c. squared.*

$$I = \sqrt{I_{ac}^2 + I_{dc}^2}$$

where  $I_{ac}$  is the effective value of the a.c. component,  $I$  is the effective value of the combination and  $I_{dc}$  is the average (d.c.) value of the combination. If the a.c. component is of sine-wave form, its maximum value will be its effective value, as determined above, multiplied by 1.414. If the a.c. component is not sinusoidal the maximum value will have a different ratio to the effective value, of course,

depending on its wave form, as discussed in the preceding section.

### Power With Pulsating Current

● In a resistance circuit, the power developed by a pulsating current will be  $I^2R$  watts,  $I$  being the effective or r.m.s. value of the current and  $R$  the resistance of the circuit in ohms. In the special case of sine-wave a.c. having *maximum* value equal to the d.c., which represents 100% modulation of the d.c. by the a.c., the effective value of the a.c. component is 0.707 (70%) of its maximum a.c. value and likewise of the d.c. value. If the two maximum values are each 1 ampere,

$$\begin{aligned} I &= \sqrt{1^2 + .707^2} \\ &= \sqrt{1.5} \\ &= 1.226 \\ P &= I^2 R \\ &= 1.5 R \end{aligned}$$

Hence, when sine-wave alternating current is superimposed on direct current in a resistance circuit *the average power is increased 50% if the maximum value of the a.c. component is equal to the d.c. component.* If the a.c. is not sinusoidal, the power increase will be greater or less, depending on the alternating-current wave form. This point is discussed further in connection with speech modulation in Chapter Eleven.

### Phase

● It has been mentioned that in a circuit containing inductance, the rise of current is

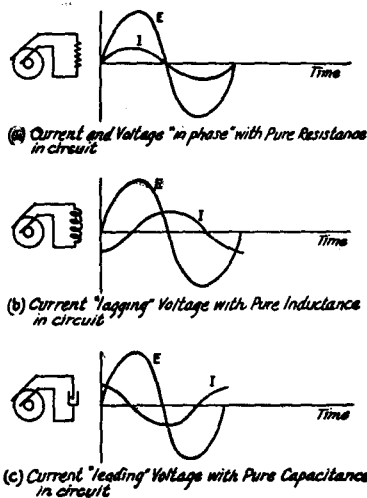

FIG. 309 — VOLTAGE AND CURRENT PHASE RELATIONS WITH RESISTANCE AND REACTANCE CIRCUITS

# . . . . . Fundamental Electrical Principles

delayed by the effect of electrical inertia presented by the inductance. Both increases and decreases of current are similarly delayed. It is also true that a current must flow into a condenser before its elements can be charged and so provide a voltage difference between its terminals. Because of these facts, we say that a current "lags" behind the voltage in a circuit which has a preponderance of inductance and that the current "leads" the voltage in a circuit where capacity predominates. Fig. 309 shows three possible conditions in an alternating current circuit. In the first, when the load is a pure resistance, both voltage and current rise to the maximum values simultaneously. In this case the voltage and current are said to be *in phase*. In the second instance, the existence of inductance in the circuit has caused the current to lag behind the voltage. In the diagram, the current is lagging one quarter cycle behind the voltage. The current is therefore said to be 90 degrees *out of phase* with the voltage (360 degrees being the complete cycle). In the third example, with a capacitive load, the voltage is lagging one quarter cycle behind the current. The *phase difference* is again 90 degrees. These, of course, are theoretical examples in which it is assumed that the inductance and the condenser have

no resistance. Actually, the angle of lag or lead depends on the ratio of reactance to resistance in the circuit.

Another kind of phase relationship frequently encountered in radio work is that between two alternating currents of identical frequency flowing simultaneously in the same circuit. Even in a circuit of pure resistance the two currents will augment or nullify each other, depending on whether they are in phase or out of phase. When two such currents are of the same frequency and in phase they are said to be *synchronized*, the maximum amplitude of the combination then being the arithmetical sum of the two separate amplitudes. The maximum amplitude will be lessened as the phase differs, reducing to zero amplitude with two equal currents when the phase angle becomes 180 degrees. The latter condition is known as *phase opposition*.

## Power Factor

● In a direct current circuit, or in an alternating current circuit containing only resistance, the power can be computed readily by multiplying the voltage by the current. But it is obviously impossible to compute power in this fashion for an alternating current circuit in which the current may be maximum when the voltage is zero; or for any case in which the voltage and current are not exactly in phase. In computing the power in an a.c. circuit we must take into account any phase difference between current and voltage. This is made possible by the use of a figure representing the *power factor*.

The *power factor* is equal to the *actual power in the circuit (watts) divided by the product of the current and voltage (volt-amperes)*. In terms of a circuit property, it is equal to the *resistance divided by the impedance in the circuit*. In the case of a circuit containing resistance only, the ratio is 1 and, hence, the power factor, is 100% (unity). If there is reactance only in the circuit (zero resistance), then the power factor is zero. In circuits containing both resistance and reactance the power factor lies between these two values. As instances, a good condenser should have nearly zero power factor as should a good choke coil. Resistors for use in a.c. circuits should, on the other hand, have a power factor approaching 100%.

### SCHEMATIC SYMBOLS USED IN CIRCUIT DIAGRAMS

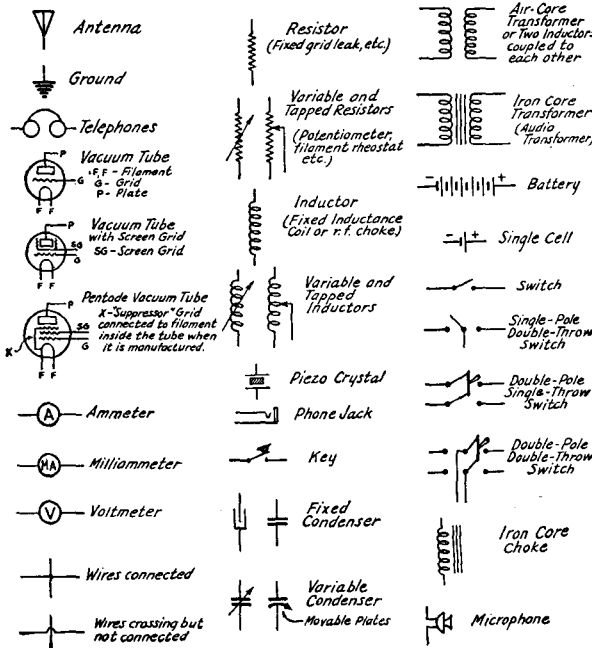

# The Radio Amateur's Handbook . . . . .

## Reading Diagrams — Schematic Symbols

● Schematic diagrams show the different parts of a circuit in skeleton form. Pictures show the apparatus as it actually appears in the station or laboratory. A little study of the symbols used in schematic diagrams will be helpful in understanding the circuits that appear in this book, *QST* and in other radio publications. The diagrams are easy to understand once we have rubbed shoulders with some real apparatus and read about it. Schematic diagrams are used in all electrical work because they save so much space and time when discussing the various circuits. Photographs of apparatus show the actual arrangement used but the wiring is not as clear as in the schematic diagrams. In building most apparatus a schematic diagram and a photograph will make everything clear. It is suggested that the beginner carefully compare a few pictures and schematic diagrams if not entirely familiar with the latter.

The symbols used in schematic diagrams throughout this book will be easily understood by reference to the accompanying figure. Most of the diagrams shown are plainly labelled or worded so that it is only necessary to know the general scheme which differentiates coils, condensers, and resistors to read the diagram. Reference to the text will help in understanding fully what is intended, since diagrams and text have been prepared to complement each other. In general, coils are indicated by a few loops of wire, resistances by a jagged line, and variable elements in the circuit by arrowheads. If a device has an iron core it is usually shown by a few parallel lines opposite the loops indicating coils or windings.

When you can draw and talk about circuits in terms of the various conventional symbols you are on what is familiar ground to every amateur and experimenter. Then you can meet the dyed-in-the-wool expert and understand what he talks about.

## Practical Examples

● There is no greater aid to the understanding of principles than their actual application to practical problems. The following typical examples, involving only simple arithmetic, show how the principles outlined in this chapter are directly useful in giving the right answers to many of the problems which arise in designing and building amateur equipment. It is suggested that they be worked through by the reader in connection with study of the various topics throughout the chapter. The calculations have been made with practical "slide-rule" accuracy.

## Ohm's Law Calculations

● 1. *Q.* — With 10 volts applied across a resistance of 1000 ohms, how much current will flow?

$$A. — I = \frac{E}{R} = \frac{10}{1000} = .01 \text{ amp.} = 10 \text{ ma.}$$

2. *Q.* — What value of resistance should be used to reduce voltage from 1000 v. to 250 v. when the current is 50 ma. (.05 amp.)?

*A.* — The necessary voltage drop is 1000 v. — 250 v. = 750 v.

$$R = \frac{E}{I} = \frac{750}{.05} = 15,000 \text{ ohms.}$$

3. *Q.* — If the grid-leak resistance of a transmitting tube is 10,000 ohms and the grid current measured with a d.c. milliammeter is 15 ma. (.015 amp.), what is the grid-bias voltage developed across the resistor?

*A.* —  $E = IR = .015 \times 10,000 = 150 \text{ volts.}$

4. *Q.* — What power is dissipated by the grid-leak resistor of *Q.* 3?

*A.* —  $P = I^2R = .015^2 \times 10,000 = 2.25 \text{ watts}$

or  $P = EI = 150 \times .015 = 2.25 \text{ watts.}$

5. *Q.* — What resistance ( $R_2$ ) should be connected in series with 7500 ohms ( $R_1$ ) to give a total resistance ( $R$ ) of 10,000 ohms?

*A.* —  $R = R_1 + R_2$

Therefore,  $R_2 = R - R_1 = 10,000 - 7500 = 2500 \text{ ohms.}$

6. *Q.* — What resistance ( $R_1$ ) should be connected in parallel with a resistance ( $R_2$ ) of 5000 ohms to give a total resistance ( $R$ ) of 4000 ohms?

$$A. — \frac{1}{R} = \frac{1}{R_1} + \frac{1}{R_2}$$

Therefore,  $R_1 = \frac{RR_2}{R_2 - R} = \frac{4000 \times 5000}{5000 - 4000} = 20,000 \text{ ohms.}$

7. *Q.* — If the power input to a load circuit is 25 watts and the load resistance is 10,000 ohms, what will be the voltage and current?

*A.* —  $E = \sqrt{PR} = \sqrt{25 \times 10,000} = 500 \text{ volts.}$

$$I = \sqrt{\frac{P}{R}} = \sqrt{\frac{25}{10,000}} = .05 \text{ amp.} = 50 \text{ ma.}$$

(Check:  $500 \text{ v.} \times .05 \text{ amp.} = 25 \text{ watts.}$ )

## Coil Calculations

● 8. *Q.* — What will be the total inductance of a filter choke of 30-henry inductance in



# . . . . . *Fundamental Electrical Principles*

series with another of 20-henry inductance, the two being separated to eliminate magnetic interaction?

A. —  $L = L_1 + L_2 = 30 + 20 = 50$  henrys.

9. Q. — What will be the inductance with the two chokes of Q. 3 connected in parallel?

A. —  $L = \frac{L_1 L_2}{L_1 + L_2} = \frac{30 \times 20}{30 + 20} = 12$  henrys.

(NOTE. — As pointed out in Chapter Fifteen, the inductance of chokes is reduced by d.c. flowing through the windings. Therefore the series inductance would tend to be less than the calculated value, while the parallel inductance might be higher than that calculated if the total direct current should be the same in both cases.)

10. Q. — What would be the approximate number of turns on the 6.5-volt secondary of a small filament transformer having a 115-volt primary of 865 turns?

A. — The secondary-to-primary voltage ratio is  $\frac{6.5}{115}$ . This is also the approximate secondary-to-primary turn ratio. Therefore, No. secondary turns =  $865 \times \frac{6.5}{115} = 49$  turns.

11. Q. — How much energy is stored in a 30-henry choke with a current flow of 100 ma. (0.1 amp.)?

A. — Energy stored =  $\frac{LI^2}{2} = \frac{30 \times 0.1^2}{2} = 0.15$  watt-second.

12. Q. — What is the reactance of a 30-henry choke at a frequency of 100 cycles per second?

A. —  $X_L = 2\pi fL = 2 \times 3.14 \times 100 \times 30 = 18,850$  ohms.

### Condenser Calculations

● 13. Q. — What is the approximate reactance of a 2- $\mu$ fd. condenser at 100 cycles per second?

A. —  $X_C = \frac{10^6}{2\pi fC} = \frac{1,000,000}{6.28 \times 100 \times 2} = 796$  ohms.

14. Q. — What is the total capacitance of a 0.001- $\mu$ fd. condenser ( $C_1$ ) and a 150- $\mu$ fd. condenser ( $C_2$ ) in parallel?

A. —  $C = C_1 + C_2 = .001 \mu\text{fd.} + .0015 \mu\text{fd.} = .00115 \mu\text{fd.}$

(Note that both capacitance values must be converted to the same units.)

15. Q. — What is the total capacitance

when the same two condensers are connected in series?

A. —  $C = \frac{C_1 C_2}{C_1 + C_2} = \frac{1000 \times 150}{1000 + 150} = 130 \mu\text{fd.}$

16. Q. — What is the energy stored in 2- $\mu$ fd. condenser with 1000 volts applied?

A. — Energy stored =  $\frac{CE^2}{2 \times 10^6} = \frac{2 \times (1000)^2}{2,000,000} = 1$  watt-second.

17. Q. — After the 1000-volt supply was shut off, what time would be required for the voltage across this condenser to drop to 370 volts with a 20,000 ohm resistance connected between its terminals? To drop to 100 volts?

A. — The time required for the voltage to fall to 37% is the time constant.

Time constant =  $\frac{RC}{10^6} = \frac{20,000 \times 2}{1,000,000} = .04$  sec.

Time for 90% voltage fall =  $\frac{RC}{10^6} \times 2.4 = .096$  second.

NOTE. — A painful shock can be obtained by touching the terminals of an *unloaded* filter condenser long after the power has been shut off. Without a bleeder resistor the time constant may be as great as several days!

18. Q. — What would be the approximate impedance at 100 cycles of a series circuit consisting of a 30-henry choke having 100 ohms resistance, a 2- $\mu$ fd. condenser of negligible resistance and a 10,000-ohm resistor?

A. — From Q. 12 the reactance of this choke is 18,850 ohms, and from Q. 13 the reactance of the condenser is 796 ohms. The net reactance is 18,850 - 796 = 18,054 ohms (inductive).

$Z = \sqrt{R^2 + X^2} = \sqrt{(10,100)^2 + (18,054)^2} = 20,650$  ohms.

### Complex Wave Calculation

● 19. Q. What would be the effective voltage of a complex wave consisting of a fundamental and third harmonic, when the maximum value of the fundamental is 10 volts and the maximum value of the third harmonic is 4 volts?

A. The effective values of the respective components will be practically 70% of their maximum values, or 7 and 2.8 volts. The effective value of the complex wave is then:

$E = \sqrt{E_1^2 + E_2^2} = \sqrt{7^2 + 2.8^2} = \sqrt{56.84} = 7.54$  volts.

# 4

## Radio Circuit and Wave Fundamentals

### PRACTICAL PRINCIPLES OF TUNED CIRCUITS— COUPLED CIRCUITS—IMPEDECE MATCHING— FILTERS—BRIDGE CIRCUITS—LINE CIRCUITS— ANTENNAS—RADIO WAVES

IN OUR discussion of fundamental electrical principles, we have seen how a flow of electrons through a wire constitutes an electric current, and how this current, under certain conditions, gives rise to electric and magnetic effects as changes in the current flow take place. In addition to the effect which resistance produces in direct and alternating current circuits, we have learned how an inductance or coil tends to prevent any change in the current flowing through it because of the existence, around the coil, of a magnetic field, which varies in strength with every variation in the current flow. We have also seen how this field around a coil can link with the turns of a second coil, so inducing voltages in it — voltages which vary in accordance with the changes in the original current flow. Further, we have seen how a condenser can be charged by an applied voltage and how the energy represented by this charge can cause a current to flow in any conductor which is connected across the condenser terminals. Lastly, we have learned that in an alternating current circuit, inductance causes the current to lag behind the voltage while capacity causes the current to lead the voltage.

Equipped with an understanding of these principles we are now ready to study inductance, capacitance and resistance as combined in the circuits of our radio transmitters, receivers and other equipment. Examination of the circuit diagram of almost any piece of radio equipment will reveal one or more combinations of coil and condenser (inductance and capacitance) and, hence, of inductive reactance and capacitive reactance. Let us now consider how they work together to form the *tuned circuit*.

### The Tuned Circuit

Let us assume that a condenser  $C$  and coil  $L$  are connected as shown in Fig. 401, and that the condenser is initially charged as indicated

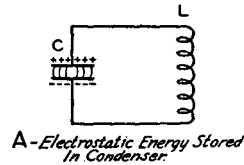

A - Electrostatic Energy Stored In Condenser.

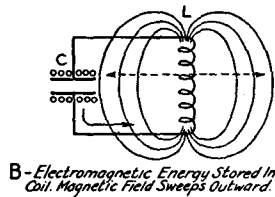

B - Electromagnetic Energy Stored In Coil. Magnetic Field Sweeps Outward.

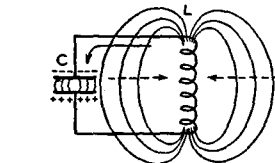

C - Electromagnetic Field of Coil Collapses Energy returned to Condenser, charging it in reverse of initial polarity.

FIG. 401 — THE SEQUENCE IN A HALF-CYCLE OF OSCILLATION IN A RESONANT CIRCUIT

in A, one plate having a surplus of electrons and therefore being negative while the other plate, being correspondingly deficient in elec-

## . . . . Radio Circuit and Wave Fundamentals

trons, is positive. The instant that the condenser plates are connected together through the coil  $L$  there will start a flow of current as shown by the arrow in B. The rate of flow of current will be retarded by the inductive reactance of the coil and the discharge of the condenser will not be instantaneous even though the velocity of flow is constant. As the current continues to flow from the condenser into the coil, the energy initially stored in the condenser as an electrostatic field will become stored in the electromagnetic field of the coil. When substantially all the energy in the circuit has become stored in this field the lines of force about the coil begin to collapse, and thus cause a continued flow of current through the circuit, the flow being in the same direction as the initial current. This again charges the condenser *but in opposite polarity to the initial charge*. Then, when all the energy again has been stored in the condenser, the sequence is repeated in the opposite direction. The process is one of *oscillation*. During one complete cycle the energy is alternately stored in the condenser and in the coil twice, and there is one reversal in the direction of current flow. This represents a complete cycle of alternating current. The process would continue indefinitely were there only inductance and capacitance in the circuit but, as has been pointed out in Chapter Three, all circuits contain some resistance. Therefore during each cycle a part of the energy will be dissipated in the resistance as heat, each cycle will be of lesser amplitude than the preceding one and the process will finally stop because there is no longer energy to sustain it. This *damping* caused by resistance is overcome in practical circuits by continuously supplying energy to replace that dissipated in resistance of one form or another, as will be shown later.

### Oscillation Frequency

● In such an oscillatory circuit, the larger the coil is made the greater will be its inductance and the longer will be the time required for the condenser to discharge through it. Likewise, the larger the condenser and the greater its capacitance, the longer it will take to charge or discharge it. Since the velocity of the current flow is substantially constant, it is clear that the circuit with the larger coil or condenser is going to take a longer period of time to go through a complete cycle of oscillation than will a circuit where the inductance and capacitance are small. Putting it differently, the number of cycles per second will be greater as the inductance and capacitance values become smaller. *Hence the smaller the coil or condenser,*

*or both, in the tuned circuit, the higher will be the frequency of oscillation.*

### Resonance

● The important practical aspect of all this is that in any circuit containing capacitance, inductance and not too much resistance, the introduction of a pulse of electrical energy will cause an alternating current oscillation of a frequency determined solely by the values of inductance and capacitance; and that for any combination of inductance and capacitance there is one particular frequency of applied voltage at which current will flow with the greatest ease. Recalling the explanations of inductive reactance and capacitive reactance given in Chapter Three, this becomes readily understandable. It has been shown that the inductive reactance of the coil and the capacitive reactance of the condenser are oppositely affected with frequency. Inductive reactance increases with frequency; capacitive reactance decreases as the frequency increases. In any combination of inductance and capacitance, therefore, there is one particular frequency for which the inductive and capacitive reactances are equal and, since these two reactances oppose each other, for which the net reactance becomes zero, leaving only the resistance of the circuit to impede the flow of current. The frequency at which this occurs is known as the *resonant frequency* of the circuit and the circuit is said to be *in resonance* at that frequency or *tuned* to that frequency.

In practical terms, since at resonance the inductive reactance must equal the capacitive reactance, then

$$X = X_C \text{ or } 2\pi fL = \frac{1}{2\pi fC}$$

The resonant frequency is, therefore,

$$f = \frac{1}{2\pi\sqrt{LC}} \times 10^6$$

where

$f$  is the frequency in kilocycles per second

$2\pi$  is 6.28

$L$  is the inductance in microhenrys ( $\mu\text{h}$ .)

$C$  is the capacitance in micro-microfarads ( $\mu\mu\text{f.d.}$ )

### LC Constants

● From this it is evident that the product of  $L$  and  $C$  is a constant for a given frequency and that *the frequency of a resonant circuit varies inversely as the square root of the product of the inductance and capacitance*. In other words, doubling both the capacitance and the inductance (giving a product of 4 times) would halve

the frequency; or, reducing the capacitance by one-half and the inductance by one-half would double the frequency; while leaving the inductance fixed and reducing the capacitance to one-half would increase the frequency only 40%. To double the frequency, it would be

## LC Constants for Amateur and Intermediate Frequencies

Frequency Band	L μh.	C μfd.	LXC
1750-kc.	90	90	8100
3500-kc.	45	45	2025
7000-kc.	22.5	22.5	506.25
14-mc.	11.25	11.25	126.55
28-mc.	5.63	5.63	31.64
56-mc.	2.82	2.82	7.91
450-kc.	355	355	126,025

necessary to reduce either the capacitance or the inductance to one-fourth (leaving the other fixed).

The accompanying table gives LC values for reference at amateur-band and superhet intermediate frequencies. This table, in combination with the above general rules, will be of practical use in estimating the constants of tuned circuits for amateur transmitters and receivers. Note that the numerically equal inductance and capacitance values listed are in microhenrys and micro-microfarads, respectively, giving L/C ratios for the three lower frequency amateur bands approximating those usual in receiver tuned circuits. These ratios would be considered relatively "low-C" or "high-L" in transmitter practice (low ratio of capacitance to inductance, or high ratio of inductance to capacitance). Extremely high-C

necessarily have to have smaller inductance values because the minimum capacitances attainable in circuits would be larger than those indicated. Practical values are given in the later chapters describing apparatus.

## Series and Parallel Resonance

All practical tuned circuits can be treated as either one of two general types. One is the *series resonant* circuit in which the inductance, capacitance, resistance and source of voltage are in series with each other. With a constant-voltage alternating current applied as shown in A of Fig. 402 the current flowing through such a circuit will be maximum at resonant frequency. The magnitude of the current will be determined by the resistance in the circuit. The curves of Fig. 402 illustrate this, curve *a* being for minimum resistance and curves *b* and *c* being for greater resistances.

The second general case is the parallel resonant circuit illustrated in B of Fig. 402. This also contains inductance, capacitance and resistance in series, but the voltage is applied in parallel with the combination instead of in series with it as in A. Here we are not primarily interested in the current flowing through the circuit but in its characteristics as viewed from its terminals, especially in the *parallel impedance* it offers. The variation of parallel impedance of a parallel resonant circuit with frequency is illustrated by the same curves of Fig. 402 that show the variation in current with frequency for the series resonant circuit. The parallel impedance is maximum at resonance and increases with decreasing series resistance. Although both series and parallel resonant circuits are generally used in radio work, the parallel resonant circuit is most frequently found, as inspection of the diagrams of the equipment described in subsequent chapters will show.

High parallel impedance is generally desirable in the parallel resonant circuit and low series impedance is to be sought in series resonant circuits. Hence low series resistance is desirable in both cases.

### Sharpness of Resonance (Q)

● It is to be noted that the curves become "flatter" for frequencies near resonance frequency as the internal series resistance is increased, but are of the same shape for all resistances at frequencies further removed from resonance frequency. The relative sharpness of the resonance curve near resonance frequency is a measure of the *sharpness of tuning or selectivity* (ability to discriminate between voltages of different frequencies) in such cir-

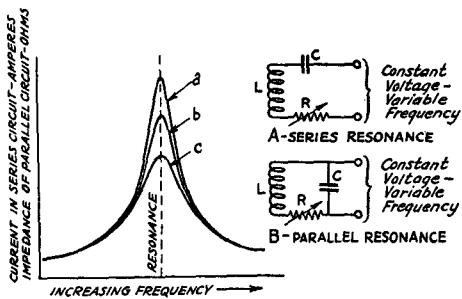

FIG. 402 — CHARACTERISTICS OF SERIES-RESONANT AND PARALLEL-RESONANT CIRCUITS

cuits for these bands would have capacitances greater by 10 times or so, and inductances proportionately smaller. Actual circuits for the three higher-frequency bands would

# . . . . Radio Circuit and Wave Fundamentals

cuits. This is an important consideration in tuned circuits used for radio work. Since the effective resistance is practically all in the coil, the condenser resistance being negligible, the efficiency of the coil is the important thing

low-frequency alternating current. This is largely due to the *skin effect*, so called because the current tends to concentrate on the outside of the conductor, leaving the inner portion carrying little or no current. It is for this reason that hollow copper tubing is widely used in the coils and connections of high-frequency circuits. However, the current may not be distributed uniformly over the surface. With flat conductors the current tends to concentrate at the edges and with square conductors it tends to concentrate at the corners. In addition to the skin effect, dielectric losses due to insulators and resistance losses in other conductors in the field of the conductor contribute to its effective resistance. *The effective resistance is measured as the power in the circuit divided by the square of the maximum effective radio-frequency current.*

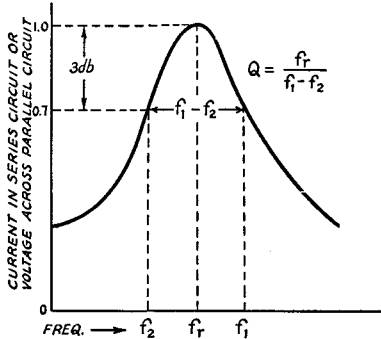

FIG. 403 — HOW THE VALUE OF  $Q$  IS DETERMINED FROM THE RESONANCE CURVE OF A SINGLE CIRCUIT

determining the "goodness" of a tuned circuit. A useful measure of coil efficiency, and hence of tuned circuit selectivity, is the ratio of the coil's reactance to its effective series resistance. This ratio will be recognized as approximately the reciprocal of the circuit property of power factor discussed in Chapter Three, and is designated by  $Q$ .

$$Q = \frac{2\pi fL}{R}$$

The value of  $Q$  is determined directly from the resonance curve of either a series-resonant or parallel-resonant circuit as shown in Fig. 403. It is given by the ratio of the resonance frequency to the difference between the frequencies at which the series current (for the series-resonant circuit) or the parallel voltage (for the parallel-resonant circuit) becomes 70% of the maximum value. A  $Q$  of 100 would be considered good for coils used at the lower amateur frequencies, while the  $Q$  of coils for the higher frequencies may run to several hundred. It must be remembered, however, that  $Q$  represents a ratio, so that the actual frequency width of the resonance curve would be proportionately greater for a high-frequency circuit than for a low-frequency circuit having the same value of  $Q$ .

### Radio Frequency Resistance — Skin Effect

● The effective resistance of conductors and coils at radio frequencies may be many times the "ohmic" resistance of the same conductors as it would be measured for direct current or

### Parallel-Resonant Circuit Impedance ( $Z$ )

● The parallel-resonant circuit offers pure resistance (its resonant impedance) between

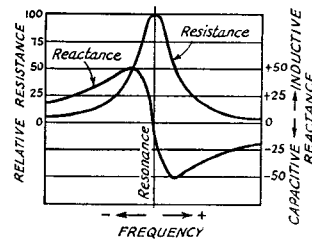

FIG. 404 — THE IMPEDANCE OF A PARALLEL-RESONANT CIRCUIT SEPARATED INTO ITS REACTANCE AND RESISTANCE COMPONENTS. THE PARALLEL RESISTANCE IS EQUAL TO THE PARALLEL IMPEDANCE AT RESONANCE

its terminals at resonance frequency, and becomes reactive for frequencies higher and lower. The manner in which this reactance varies with frequency is shown by the indicated curve in Fig. 404. This figure also shows the *parallel resistance* component which combines with the reactance to make up the impedance. The reactive nature of parallel impedance at frequencies off resonance is important in a number of practical applications of parallel-tuned circuits, in both transmitters and receivers, and it will be helpful to keep this picture in mind. Note that the reactance component becomes practically equal to half the resistance component, capacitively above and inductively below resonance. This occurrence is especially important in the variable-selectivity action of the quartz crystal filter circuit used in Single-Signal superhet receivers, as described in Chapter Six.

The maximum value of parallel impedance which is obtained at resonance is proportional to the square of the inductance and inversely proportional to the series resistance. (This resistance should not be confused with the resistance component of parallel impedance which has just been mentioned.)

$$\text{Resonant impedance} = \frac{(2\pi f_r L)^2}{R}$$

$$\text{Since } \frac{2\pi f_r L}{R} = Q,$$

$$\text{Resonant impedance} = (2\pi f_r L)Q$$

In other words, the impedance is equal to the inductive reactance of the coil (at resonant frequency) times the  $Q$  of the circuit. Hence, the voltage developed across the parallel resonant circuit will be proportional to its  $Q$ . For this reason the  $Q$  of the circuit is not only a measure of the selectivity, but also of its gain or amplification, since the voltage developed across it is proportional to  $Z$ . Likewise, the  $Q$  of a circuit is related to the frequency stability of an oscillator in which it is used, the frequency stability being generally better as the circuit  $Q$  is higher. This is illustrated in practical applications described in subsequent chapters.

### The Piezo-Electric Crystal Circuit

- All of the tuned circuits used in radio transmitters and receivers are not purely electrical

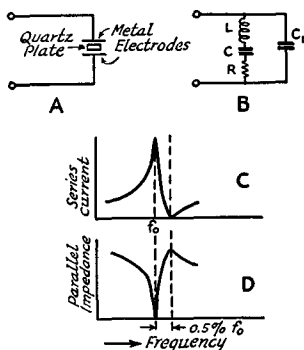

FIG. 405 — THE EQUIVALENT ELECTRICAL CIRCUIT OF THE QUARTZ CRYSTAL PLATE

in nature. Electro-mechanical or piezo-electric types are used as well. Of the latter, the quartz crystal is most generally employed. The schematic representation of a quartz crystal plate mounted between a pair of metal electrodes is

shown in Fig. 405-A and the equivalent electrical circuit is shown in Fig. 405-B. It consists of inductance,  $L$ , capacitance,  $C$ , and resistance  $R$ , in the series combination, paralleled by  $C_1$ , which is the capacitance between the electrodes with the quartz as dielectric.

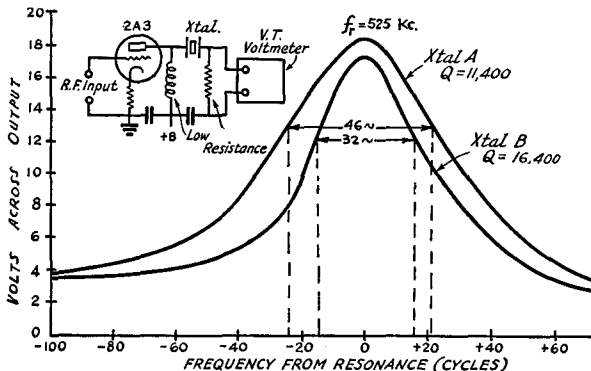

FIG. 406 — RESONANCE CURVES OF TWO PRACTICAL CRYSTAL RESONATORS, SHOWING THEIR HIGH  $Q$

As with any series circuit containing inductance and capacitance, resonance occurs at the frequency for which the inductive and capacitive reactances are equal. This frequency ( $f_r$ ) is termed the *natural frequency* of the crystal. In contrast to the parallel-resonant case, at frequencies below resonance the series circuit has capacitive reactance and above resonance it has inductive reactance. At a certain frequency above series resonance in the crystal circuit, the inductive reactance of the series combination becomes equal to the capacitive reactance of the parallel capacitance  $C_1$ . At this frequency parallel resonance occurs and the crystal acts as an anti-resonant circuit.

The ratio of the parallel capacitance  $C_1$  to the series capacitance  $C$  is approximately 125-to-1, irrespective of the constants of the crystal, so that this anti-resonant frequency is always approximately 0.5 percent higher than the natural series-resonance frequency, as shown by Curves C and D of Fig. 405. The value of this frequency is determined by the dimensions of the quartz plate and the angle of its cut with respect to the axes of the natural crystal. Data on cuts and frequencies are given in Chapters Six and Eight, along with practical information on the use of quartz crystals as series circuits in receivers and parallel circuits in transmitters.

The ratio of equivalent inductance to resistance is very large in a quartz crystal, which gives it an extraordinarily high  $Q$ . This is

# . . . Radio Circuit and Wave Fundamentals

illustrated by the series resonance curves of Fig. 406, taken for frequencies near resonance with two apparently identical 525-kc. crystals. The difference between the two is probably the result of slight variations in their cutting and

inductance in each determine the *coefficient of coupling*. Many turns in two coils very close together give us tight coupling and a big transfer of power. Few turns at right angles or far apart give us loose coupling with little actual energy transfer.

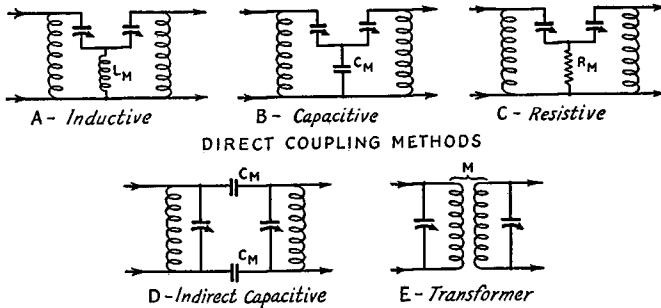

FIG. 407 — BASIC TYPES OF CIRCUIT COUPLING

grinding. But both show  $Q$  values running 50 or more times higher than could be obtained with a good coil at the same frequency. Hence the wide use of crystals as selective radio-frequency circuits and for stabilizing oscillators.

### Coupled Circuits

Resonant circuits are not used alone in very many instances but are usually associated with other resonant circuits or are *coupled* to other circuits. It is by such coupling that energy is transferred from one circuit to another. Such coupling may be *direct*, as shown in A, B and C of Fig. 407, utilizing as the mutual coupling element, inductance (A), capacitance (B) or resistance (C). These three types of coupling are known as *direct inductive*, *direct capacitive* or *direct resistive*, respectively. Current circulating in one  $LC$  branch flows through the common element ( $C$ ,  $R$  or  $L$ ) and the voltage developed across this element causes current flow in the other  $CL$  branch. Other types of coupling are the *indirect capacitive* and *transformer* or *inductive* shown below the others. The coupling most common in high-frequency circuits is of the latter type. In such an arrangement the coupling value may be changed by changing the number of active turns in either coil or by changing the relative position of the coils (distance or angle between them). The arrangement then performs in a manner similar to the transformer described in the previous chapter.

All of the above coupling schemes may be classified as either tight or loose. Coupling cannot, however, be measured simply in "inches" separation of coils. The separation between the coils (distance and angle between axes) and the

### Coefficient of Coupling ( $k$ )

● The common property of two coils which gives transformer action is their *mutual inductance* ( $M$ ). Its value is determined by self-inductance of each of the two coils and their position with respect to each other. In practice, the coupling between two coils is given in terms of their *coefficient of coupling*, designated by  $k$ .

As was shown for closed iron-core transformer in Chapter Three, the coupling is maximum (unity or 100%) when all of the flux produced by one coil links with all of the turns of the other. With air-core coils in radio-frequency circuits the coupling is much "looser" than this, however. It is generally expressed by the following relation:

$$k = \frac{M}{\sqrt{L_1 L_2}}$$

in which  $k$  is the coefficient of coupling expressed either as a decimal part of 1, or, when multiplied by 100, as a percentage;  $M$  is the mutual inductance;  $L_1$  is the self-inductance of one coil; and  $L_2$  is the self-inductance of the other coil.  $M$ ,  $L_1$  and  $L_2$  must be in the same units (henrys, millihenrys or microhenrys).

*Critical coupling* is that which gives the maximum transfer of energy from the primary to the secondary. However, the sharpness of resonance for the combination is considerably lessened under this condition, the resonance curve usually having two "humps" appreciably separated. For good selectivity the coupling is therefore made considerably less than the critical value, even though this reduces the amplification or gain. With the coil combinations used in radio receivers, coupling of the order of  $k=0.05\%$  or less is representative, whereas for critical coupling the coefficient might be 0.5% to 1.0%. The value of the coefficient for critical coupling is also related to the respective  $Q$ 's of the two coils:

$$k_{\text{crit.}} = \frac{1}{\sqrt{Q_p Q_s}}$$

where the two  $Q$  values are for the primary and secondary, respectively. For instance, if the

primary and secondary  $Q$ 's are equal, the value of critical  $k$  is the reciprocal of the  $Q$  for one coil — 0.01 or 1% where each has a  $Q$  of 100. Therefore, for the same values of self-inductance,  $k$  becomes smaller as  $Q$  becomes higher.

It should be kept in mind that, as has been previously mentioned, both single resonant circuits and coupled circuits are used in conjunction with other circuit elements. These other elements introduce resistance into the resonant circuits we have been discussing, and modify the constants that they would have by themselves. In practice it is seldom possible for the amateur to pre-calculate the effect of such reactions, since the other quantities are usually unknown. In any case, it is usually necessary to arrive at "best conditions" by the practical process of adjustment. However, the foregoing general information is helpful in preliminary design or choice of tuned circuit combinations, and in understanding why certain changes are likely to cause different behavior in circuit performance.

## Impedance Matching

It is a well-known principle in radio circuit design that the maximum gross power of a generator, such as a vacuum tube, will be delivered to its load when the load resistance is equal to the internal resistance of the generator. In other words, maximum power will be taken from the generator when its resistance was *matched* by the load resistance. Although this particular statement is literally true, it might not describe the most desirable condition for loading the tube. For one thing, the efficiency would be only 50%, half the power being consumed in the generator and half in the load. From the principle, however, has grown up a system of more or less standard practice in designing radio circuits which comes under the broad heading of *impedance matching*. The term means, generally, *that the load impedance*

audio-frequency amplifiers, for instance. In such cases the value of proper load resistance (load impedance) for maximum undistorted power output will be given for the tube. This *load resistance*, it will be noted, is not the same as the rated *plate resistance* of the tube, which is equivalent to its internal resistance as

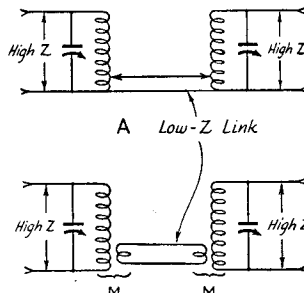

FIG. 409 — METHODS OF USING LINK COUPLING FOR IMPEDANCE MATCHING

a generator. A second figure will be given for the actual impedance of the load device to which the tube must supply undistorted power. The matching of this load to the given requirements of the tube is the job of the coupling transformer, the job being to make the actual impedance of the load device look like the rated load impedance of the tube, so far as the tube is concerned. This requires that the transformer have the proper ratio of secondary to primary turns. *The turn ratio will be equal to the square root of the impedance ratio.*

$$\frac{N_s}{N_p} = \sqrt{\frac{Z_s}{Z_p}}$$

where  $N_s$  and  $N_p$  are the numbers of secondary and primary turns,  $Z_s$  is the impedance of the load device and  $Z_p$  is the rated load resistance of the tube. This will also be the voltage ratio of the transformer, incidentally, as was shown in Chapter Three.

Transformers are also used to provide proper impedance matching in radio-frequency circuits, although here the problem is not one of simply choosing a calculated turn ratio. Rather, the right condition is arrived at by adjustment of turns and distance between coils, as shown in the later chapters on transmitters.

### Matching by Tapped Circuits

● In addition to impedance matching by inductive coupling with tuned circuits, frequent use is made of tapped resonant circuits. Two

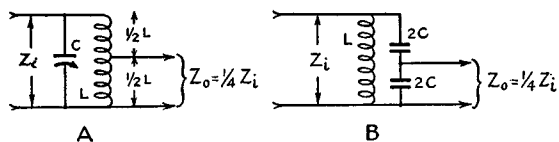

FIG. 408 — METHODS OF TAPPING THE PARALLEL IMPEDANCE OF RESONANT CIRCUITS FOR IMPEDANCE MATCHING

presented to the source is transformed to suit given requirements. This is accomplished by transformers and other coupling devices.

Iron-core transformers are widely used for coupling between load and vacuum-tube in



# . . . . Radio Circuit and Wave Fundamentals

methods for parallel resonant circuits are illustrated in Fig. 408. In one case (A) the tapping is across part of the coil, while in the other (B) it is across one of two tuning condensers in series. In both cases the impedance between the tap points will be to the total imped-

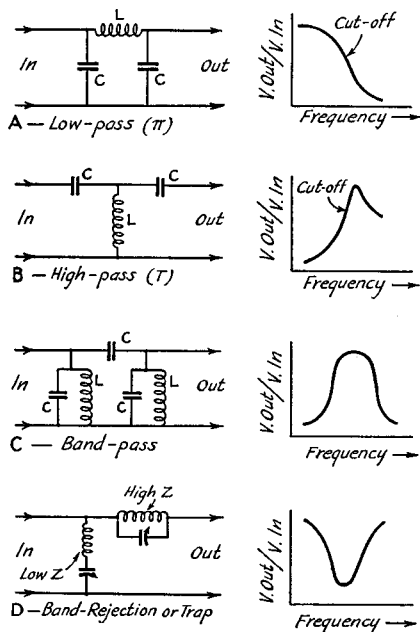

FIG. 410 — TYPES OF FILTERS AND APPROXIMATE CHARACTERISTICS OF EACH

ance practically as the square of the reactance between the tap points is to the total reactance of the branch in which the tapping is done. That is, if the coil is tapped in the center the reactance between the tap points will be one-half the total inductive reactance and the impedance between these points will be  $(\frac{1}{2})^2$  or one-fourth the total parallel impedance of the circuit. The same will apply if the tap is made across one of two equal capacitance condensers connected in series. If the condenser across which the tap was made had twice the capacitance of the other, however, the impedance  $Z_0$  would be one-ninth the total, since the reactance between the tap points would then be but a third — capacitive reactance decreasing as the capacitance is increased.

### Link Coupling

● Another coupling arrangement used for impedance matching radio-frequency circuits is that known as *link coupling*. It is used for transferring energy between two tuned circuits

which are separated by space so that there is no direct mutual coupling between the two coils. It is especially helpful in minimizing incidental capacitive coupling between the two circuits due to the distributed capacitance of the windings, thereby minimizing the transfer of undesired harmonic components of the desired fundamental. Two typical versions of link coupling are shown in Fig. 409. Both represent an impedance step-down from one tuned circuit to the coupling line, and then an impedance step-up from the line to the other tuned circuit.

The arrangement of Fig. 409-A will be recognized as an adaptation of the impedance-tapping method previously shown in Fig. 408-A. It is sometimes called auto-transformer link coupling, because the link turns are also included in the tuned-circuit turns. The arrangement of 409-B differs only in that the link turns are separate and inductively coupled to the tuned-circuit turns. The latter system is somewhat more flexible in adjustment than the

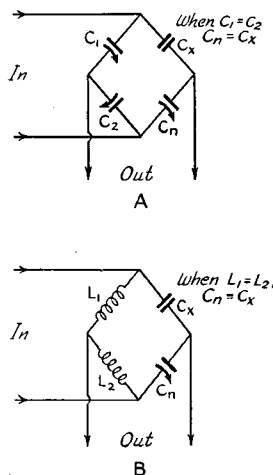

FIG. 411 — CAPACITANCE AND INDUCTANCE-CAPACITANCE BRIDGE CIRCUITS WIDELY USED FOR NEUTRALIZING IN TRANSMITTERS AND RECEIVERS

tapping method, since the coupling at either end of the line can be adjusted in small steps by moving the link turns with respect to the tuned-circuit coils. Practical applications of such link coupling in various forms are described in Chapters Eight and Nine.

### Filter Circuits

Although any resonant circuit is useful for selecting energy of a desired frequency and rejecting energy of undesired frequencies, cer-

tain combinations of circuit elements are better adapted to transmitting more or less uniformly over a *band* of frequencies, or to rejecting over a *band* of frequencies. Such rejecting action is known as *attenuation* and such combinations are called *filters*. Filter combinations are basically of three types, as illustrated in the simple forms of Fig. 410. A *low-pass* filter, as shown in *A*, is used to transmit energy below a given frequency limit and to attenuate energy of higher frequencies. Filters of this type are generally used with iron-core coils or filter chokes in plate power supply systems for transmitters and receivers. A combination of inductance and capacitance elements of the arrangement of *A* is known as a " $\pi$ " or " $\pi$ " section because its appearance resembles that of the Greek letter. A section of the type illustrated in *B* is of opposite character to that shown in *A*, passing frequencies above a designated cut-off limit and attenuating lower frequencies and therefore being designated *high-pass*. The one shown is known as a "T" section, because its form resembles that letter. Such filters are not used to any great extent in amateur work.

A type of filter for transmitting over a band of frequencies and attenuating outside this band is shown in *C*. A combination giving this action is termed a *band-pass filter*. The particular section shown will be recognized as having the same form as the indirect-capacitive coupling arrangement of Fig. 407. Similar performance is also obtainable with two tuned circuits inductively coupled. Therefore, such tuned transformers with proper coupling are used as band-pass filters, particularly in the intermediate-frequency circuits of superheterodyne receivers.

A particular combination of series-resonant and parallel-resonant circuits intended to attenuate over a narrow band of frequencies and transmit at frequencies outside that band is shown in *D* of Fig. 410. The series-resonant circuit would give a very low shunt path impedance at one particular frequency, while the parallel-resonant circuit in the series path would have high impedance at that frequency. Both would therefore combine to reject or trap out energy over a narrow band of frequencies. Such action is used in wave traps, as described for use with receivers further on.

A given type of filtering action is increased by using more sections in cascade, or combined effects are obtained by combining different types of filter sections. The subject of filters in all their variations is a highly specialized and complex matter, however, and cannot be covered in further detail here. The interested

reader may refer to any standard communication or radio engineering text for further information.

## Bridge or Neutralizing Circuits

Another special type of circuit widely used in transmitters, and to some extent in receivers, is the *bridge circuit*. Employing combinations of inductance and capacitance, it is used especially to neutralize the undesired coupling effect of a capacitance while permitting desired coupling. For instance, bridge combinations are generally used for neutralizing the grid-plate capacitance of triode tubes in transmitter r.f. amplifiers to prevent the feed-back of energy from the plate to the grid circuit. A bridge circuit is also used in the crystal filter of the Single-Signal type superheterodyne to modify the effective shunt capacitance of the crystal. Such bridge circuits are generally of the forms shown in Fig. 411. When the bridge is balanced, there will be no voltage across one pair of terminals when excitation is applied to the other terminals. In most practical cases two arms of the bridge will be capacitances  $C_1$  and  $C_2$  as shown in *A*, or inductances  $L_1$  and  $L_2$  shown in *B*. In both cases  $C_x$  is the capacitance to be neutralized, while  $C_n$  is the capacitance adjusted to obtain the balance. With the capacitance arms of *A*, balance will be obtained when

$$C_n = \frac{C_2 C_x}{C_1},$$

while with inductance arms of *B*, balance will be obtained when

$$C_n = \frac{L_1 C_x}{L_2}$$

When  $L_1 = L_2$  in *A*, or when  $C_1 = C_2$  in *B*, then  $C_n = C_x$ . This represents a desirable condition in practical neutralizing circuits, because balance will be maintained over a wider frequency range of  $L_1$ ,  $L_2$  or  $C_1$ ,  $C_2$  tuning.

Bridge circuits are also generally used in resistance, inductance and capacitance measurement. Such bridges usually have calibrated resistances in two arms, and a calibrated resistance, inductance or capacitance in the " $n$ " arm, the unknown being connected in the " $x$ " arm. Another field in which bridges find important applications is wire communication. Standard texts describe a number of these interesting applications. Those just explained are the ones of greatest practical use to amateurs, however.

# . . . . Radio Circuit and Wave Fundamentals

## Circuits with Distributed Constants

### Antennas and R.F. Chokes

● In addition to resonant circuits containing lumped capacitance and inductance, there are important tuned circuits in which no condensers and coils are to be found. Such circuits utilize the distributed capacitance and inductance that are inevitable even in a circuit consisting of a single straight conductor. Our transmitting and receiving antennas are such circuits and depend on their distributed capacitance and inductance for tuning. A peculiarity of such a circuit is that when it is excited at its resonant frequency the current or voltage, as measured throughout its length, will have different values at different points. For instance, if the wire happens to be one in "free space" with both ends open circuited, when it is excited at its resonant frequency the current will be maximum at the center and zero at the ends. On the other hand, the voltage will be maximum at the ends and zero at the center. The explanation of this is that the traveling waves on the wire are reflected when they reach an end. Succeeding waves traveling toward the same end of the wire (the incident waves) meet the returning waves (reflected waves) and the consequence of this meeting is that currents add up at the center and voltages cancel at the center; while voltages add up at the ends and currents cancel at the ends. A continuous succession of such incident and reflected waves therefore gives the effect of a standing wave in the circuit.

A similar standing-wave or straight-line resonance effect is experienced even when the conductor is wound in a long spiral, or coil having diameter small in proportion to its length. A single-layer radio-frequency choke is such a coil. It offers particularly high impedance between its ends at its resonant frequency and also, as will be presently shown for antennas, at multiples of its fundamental resonant frequency. Either side of these resonance peaks it has fairly high impedance, if it is a good choke, and therefore is useful over a considerable band of frequencies. Practically the same results are obtained with chokes consisting of a number of layer-wound sections, with all the sections connected in series. Several types of compact multi-section r.f. chokes are available from manufacturers and have largely displaced bulkier single-layer chokes in recent times.

### Frequency and Wavelength

● Although it is possible to describe the constants of such line circuits in terms of in-

ductance and capacitance, or in terms of inductance and capacitance per unit length, it is more convenient to give them simply in terms of fundamental resonant frequency or of length. In the case of a straight-wire circuit, such as an antenna, length is inversely proportional to lowest resonant frequency. Since the velocity of the waves on the wire is nearly the same as the velocity in space, which is 300,000 kilometers or 186,000 miles per second, the wavelength of the waves is

$$\lambda = \frac{300,000}{f_{\text{kc.}}}$$

where  $\lambda$  is the wavelength in meters and  $f_{\text{kc.}}$  is the frequency in kilocycles. The length of an antenna is specified in terms of the wavelength corresponding to the lowest frequency at which it will be resonant. This is known as its fundamental frequency or wavelength. As will be shown in the chapter on Antennas, this length is (very nearly) a half-wavelength for an ungrounded (Hertz) antenna and a quarter-wavelength for a grounded (Marconi) antenna. Therefore it is common to describe antennas as half-wave, quarter-wave, etc., for a certain frequency ("half-wave 7000-ke. antenna," for instance).

Wavelength is also used interchangeably with frequency in describing not only antennas but also for tuned circuits, complete transmitters, receivers, etc. Thus the terms "high-frequency receiver" and "short-wave receiver," or "75-meter fundamental antenna" and "4000-kilocycle fundamental antenna"

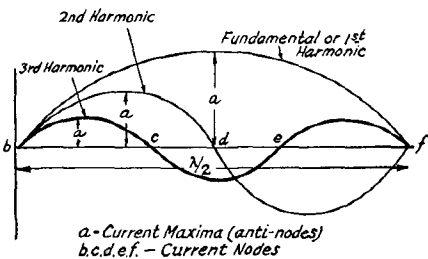

FIG. 412 — STANDING-WAVE CURRENT DISTRIBUTION ON AN ANTENNA OPERATING AS AN OSCILLATORY CIRCUIT AT ITS FUNDAMENTAL, SECOND HARMONIC FREQUENCIES AND THIRD HARMONIC FREQUENCIES

are synonymous. A chart showing the relationship between frequencies and wavelengths, including those of the amateur bands, is given in the Appendix. The resonance equation of a tuned circuit, previously given for frequency, is expressed in terms of wavelength as follows:

$$\lambda = 1.885\sqrt{L_{\mu h}C_{\mu\mu fd}}$$

where

- $\lambda$  is the wavelength in meters
- $L_{\mu h}$  is the inductance in microhenrys
- $C_{\mu\mu fd}$  is the capacitance in micro-microfarads.

### Harmonic Resonance

● Although a coil-condenser combination having lumped constants (capacitance and in-

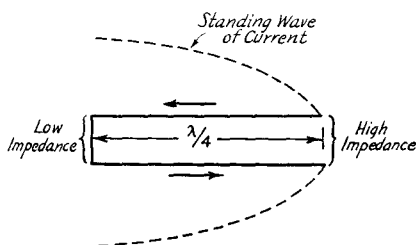

FIG. 413 — STANDING WAVE AND INSTANTANEOUS CURRENT CONDITIONS OF A FOLDED RESONANT-LINE CIRCUIT

ductance) resonates at only one frequency, circuits such as antennas containing distributed constants resonate readily at frequencies which are integral multiples of the fundamental frequency (or wavelengths that are integral fractions of the fundamental wavelength). These frequencies are therefore in *harmonic* relationship to the fundamental frequency and, hence, are referred to as *harmonics*. In radio practice the fundamental itself is called the *first harmonic*, the frequency twice the fundamental is called the *second harmonic*, and so on. For example, a Hertz antenna having a fundamental of 1790 kc. (in the amateur 1750-kc. band) also will oscillate at the following harmonic frequencies: 3580 kc. (2nd), 5370 kc. (3rd), 7160 kc. (4th), 8950 kc. (5th), 10,740 kc. (6th), 12,530 kc. (7th) and 14,320 kc. (8th). Hence the one antenna can be used for four amateur bands, resonating at its first, second, fourth and eighth harmonics. A "free" antenna (Hertz) may be operated at the fundamental or any harmonic frequency, odd or even; a grounded (Marconi) type only at its fundamental or harmonics that are *odd* multiples of the fundamental frequency.

Fig. 412 illustrates the distribution of the standing waves on a Hertz antenna for its fundamental, second and third harmonics. There is one point of maximum current with fundamental operation, there are two when operation is at the second harmonic and three at the third harmonic; the number of current maxima corresponds to the order of the har-

monic and the number of standing waves on the wire. As noted in the figure, the points of maximum current are called *anti-nodes* (also known as "loops") and the points of zero current are called *nodes*.

### Radiation By Antennas

● So far we have discussed the antenna with respect to its ability to perform as a resonant circuit. We now come to the practical use that is made of the energy that oscillates in the antenna. It will be remembered that in the preceding chapter it was shown that current flow in a conductor was accompanied by a magnetic field about the conductor; and that with an alternating current the energy was alternately stored in the field in the form of lines of magnetic force and *returned to the wire*. Now this is quite true when the alternating current is of low frequency, such as the 60-cycle kind commonly used. But when the frequency becomes higher than 15,000 cycles or so (radio frequency) all the energy stored in the field is not returned to the conductor but some escapes in the form of electro-magnetic waves. In other words, energy is radiated. This we know. Just how radiation occurs is not clearly understood at the present time. But we know enough for practical purposes about what happens in the antenna and about how the waves behave after leaving the antenna.

Some radiation will occur with any conductor that has high-frequency current flowing in it but the radiation is greatest when the antenna is resonant to the frequency of the current. If the antenna is essentially "in free space" (isolated from other wires, pipes, trees, etc., that might absorb energy from it), nearly all the energy put into it will be radiated as radio waves. As was seen in the paragraph on "Radio-Frequency Resistance," *the radio-frequency resistance is equal to the actual power in the circuit divided by the square of the maximum effective current*. Energy radiated by an antenna is equivalent to energy dissipated in a resistor. The value of this equivalent resistance is known as *radiation resistance*. Its average value for a Hertz (ungrounded) antenna operating at its fundamental frequency is approximately 70 ohms; and for a Marconi (grounded) antenna operating at its fundamental is about half this value, or 35 ohms. Since it is impossible to measure radio-frequency power directly with ordinary instruments, the approximate value of the power in an antenna can be computed by multiplying its assumed radiation resistance by the square of the maximum current (the current at the center of a fundamental Hertz antenna).

# . . . . Radio Circuit and Wave Fundamentals

Antenna power (watts) — Radiation resistance (ohms)  $\times$  Current Squared (Amperes<sup>2</sup>)

The antenna must, of course, be coupled to the transmitting equipment that generates the radio-frequency power. Practical methods of doing this are described in Chapter Twelve, together with details of the antenna systems most useful in amateur transmission.

The receiving antenna is the reciprocal of the transmitting antenna in operation. Whereas radio-frequency current in the transmitting antenna causes the radiation of electro-magnetic waves, the receiving antenna intercepts such waves and has a voltage induced in it. This voltage causes a flow of radio-frequency current of identical frequency to the radio receiver and through its tuned circuits. Generation of radio-frequency power by the transmitter and reception of radio-frequency waves will be discussed in succeeding chapters.

## Folded Resonant-Line Circuits

● The effective resistance of a resonant straight wire — that is, of an antenna — is seen to be considerable. Because of the power radiated, or “coupled” to the surrounding medium, the resonance curve of such a straight-line circuit is quite broad. In other words, its  $Q$  is relatively low. However, by folding the line, as suggested by Fig. 413, the fields about the adjacent sections largely cancel each other and very small radiation results. The radiation resistance is greatly reduced and we have a line-type circuit which can be made to have a very sharp resonance curve or high  $Q$ .

A circuit of this type will have a standing wave on it, as shown by the dash-line of Fig. 413, with the instantaneous current flow in each wire opposite in direction to the flow in the other, as indicated by the arrows on the diagram. This opposite current flow accounts for the cancellation of radiation. Furthermore, the impedance across the open ends of the line will be very high, thousands of ohms, while the impedance across the line near the closed end will be very low, as low as 25 ohms or so at the lowest. Hence, such lines can be used for impedance matching, as shown for antenna systems in Chapter Sixteen, as well as for stable oscillator circuits in ultra-high frequency transmitters, as shown in Chapter Fourteen. Resonant lines having effective lengths of odd multiples of a quarter-wavelength, or multiples on a half-wavelength, are also widely used by amateurs for coupling between the transmitter and the radiating portion of the antenna system, as is also shown in the later chapter on antenna systems.

## Non-Resonant Transmission Lines

● If a two-wire line were made infinitely long there would be no reflection from its far end when radio-frequency energy was supplied to the input end. Hence, there would be no standing waves on the line and it would be, in effect, non-resonant. The input impedance of such a line would have a definite value of impedance

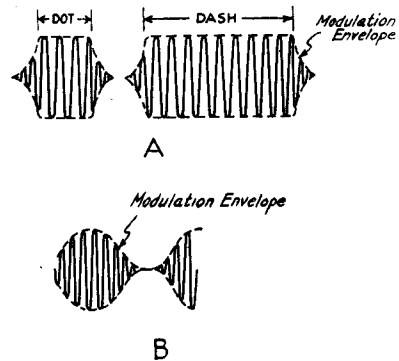

FIG. 414 — REPRESENTING THE MODULATED CURRENT OF A TELEGRAPH WAVE (A) AND SINUSOIDALLY MODULATED SPEECH WAVE (B), AMPLITUDE MODULATION

determined, practically, by the size of the wires, their spacing and the dielectric between them. This impedance is called the *surge impedance* or *characteristic impedance*. If this line were cut and it was terminated, at a definite distance from the input end, by an impedance equal to the surge impedance of the infinite line, again there would be no reflections from the far end and, consequently, no standing waves. Hence, suiting the surge impedance of the line by the proper terminating load impedance is a practical case of impedance matching. As with the resonant lines mentioned above, matched-impedance lines are also used for coupling amateur transmitters to antenna-system radiators. Although somewhat less adaptable than the resonant type line, they are considered more efficient for transmission at radio-frequency power when the line length is a wavelength or more, the line losses and incidental radiation being less with the standing waves eliminated. The practical design features of these lines also are discussed in Chapter Sixteen.

## Modulation and Detection

For practical communication between our stations it is not enough simply to generate radio frequency power continuously and

# The Radio Amateur's Handbook . . . . .

radiate it from an antenna. Something must be done before the waves are transmitted to make them carry the messages we wish to convey. Application of this intelligence to the transmitted wave is accomplished by a process of *modulation*. Without such modulation the radio wave would carry no more intelligence to the receiver than would a mail letter containing only a blank sheet of paper. A further processing of the wave must occur in the receiver to make the message understandable to our human senses. This is accomplished by a process of *detection* or, as it is sometimes known, *demodulation*. It is necessary because the modulated radio wave in its transmitted form cannot be detected directly by our ears, eyes, feeling or smell, as would be possible with sound or light waves, slow mechanical vibrations — or even “modulated” odors! Practical methods of modulation and detection by vacuum-type circuits are described separately in the next and subsequent chapters. Only a generalized explanation which suggests their broad general principle and shows their kindred nature will be given here.

*Modulation is the process of varying the radio wave to impart to it the signal which we wish to transmit; while detection is the process of extracting from the wave the signal imparted to it in the modulating process.* In amateur communication the variation applied is in amplitude; that is we use *amplitude modulation*. The signal may be either speech, for telephony, or the dot-and-dash combinations of the telegraph code. Variations in radio-frequency current generally representative of amplitude

Chapter Three, do not tell the whole story. They only picture the *synthesis wave* which actually contains components of more than one frequency.

In reality, each modulated wave shown would contain components of at least three

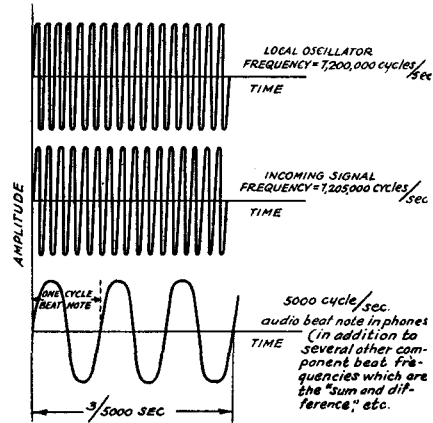

FIG. 416—A COMBINATION OF TWO RADIO-FREQUENCY WAVES OF DIFFERENT FREQUENCIES TO PRODUCE A BEAT NOTE BY HETERODYNE ACTION

The two waves would have to be simultaneously detected in the same circuit to produce the beat note, which would not be of sinusoidal wave form unless one of the combining waves was considerably greater in amplitude than the other.

radio frequencies. It is a physical fact that any change in amplitude of a wave results in additional components having frequencies equal to the sum of the original frequency and the modulation frequency, and equal to the difference between the original frequency and the modulation frequency. These additional frequencies are called *side-band frequencies*, while the original frequency component is called the *carrier*. With hand keying the modulation frequency for telegraphy is relatively low, averaging only a few cycles per second, so that the side-band frequencies differ but the same few cycles from the carrier frequency. Hence a telegraph wave in amateur communication requires a relatively narrow *communication band* (50 cycles and less). With speech, however, the essential modulation frequencies range up to approximately 3000 cycles per second and the side-

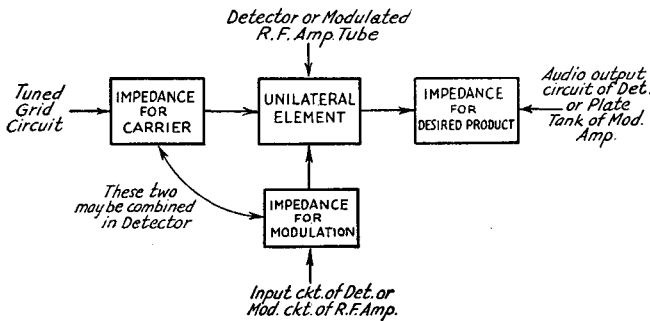

FIG. 415—GENERALIZED SYSTEM FOR MODULATION OR DETECTION, INDICATING THE ESSENTIAL ELEMENTS

modulation by these two types of signal are shown in Fig. 414. Telegraph modulation to form the letter “A” is shown in diagram A, while modulation by a sinusoidal sound is shown in B. It must be emphasized that these pictures, like the one of a complex wave in

# . . . . Radio Circuit and Wave Fundamentals

bands extend correspondingly either side of the carrier. With such amplitude modulation the communication band is twice the highest modulation frequency, so that speech telephony requires a communication band width as great as 6000 cycles (6 kc.).

To accomplish modulation the four essential circuit elements shown in the block diagram of Fig. 415 are necessary. The heart of the system is a detecting element having unilateral or one-way current flow properties. The vacuum tube is such a device, and is universally used for the purpose. A similar combination is required for detection when the modulated wave is received, also shown by Fig. 415. In reception of speech modulated waves the side-band components intermodulate or *beat* with the carrier to reproduce the original modulating signal (speech) in the output of a circuit which is essentially a counterpart of that used for transmission, as is also indicated in Fig. 415.

## Heterodyne Action

● For reception of telegraph waves modulated only by keying, however, an additional modulation to make the dots and dashes come out with continuous tone is necessary, because the side-band components resulting from keying occur only at the times when the wave amplitude is being changed (at the beginning and end of each dot and dash). Only a "click" would be heard at these times and there would be no sound in between if there were no additional modulation. This tone is obtained by applying to the detector circuit a modulating signal from a local source, this signal differing from the received radio wave frequency by a frequency equal to the desired tone — say 1000 cycles per second. There will then be produced in the detector output audible dots and dashes, corresponding to those transmitted, having a pitch of this frequency. This

process is called *heterodyne* detection, and the tone produced is known as the *beat note*. The production of such a beat note by combining two waves of slightly different frequency is suggested by Fig. 416. The beat product is not likely to be of sinusoidal wave-form, however, unless the locally generated signal is much greater in amplitude than the wave with which it is heterodyned.

## Polarization and Reflection of Radio Waves

Radio waves are of the same nature as light waves, traveling with the same velocity of 186,000 miles or 300,000 kilometers per second. They are *electro-magnetic* waves, having an electric component and an accompanying magnetic component. These vector components are in phase *quadrature*, or at a phase angle of 90 degrees, in space. The waves are *plane waves*; the plane of the electric and magnetic vectors is always at right angles to the line along which the waves are traveling. The waves are said to be *vertically polarized* when the wave travels with its electric vector perpendicular to the earth, and are said to be *horizontally polarized* when the electric vector is parallel to the earth. The polarization at transmission will correspond to the position of the antenna which radiates the waves, vertical or horizontal, although the polarization may shift as the wave travels through space or encounters incidental conductors in its path. The polarization of the waves at the receiving point is of practical importance because the voltage induced in the receiving antenna will be greatest when the antenna is placed to suit the particular polarization of the wave — vertical for vertically polarized waves and horizontal for horizontally polarized waves.

Radio waves, like light waves, can be re-

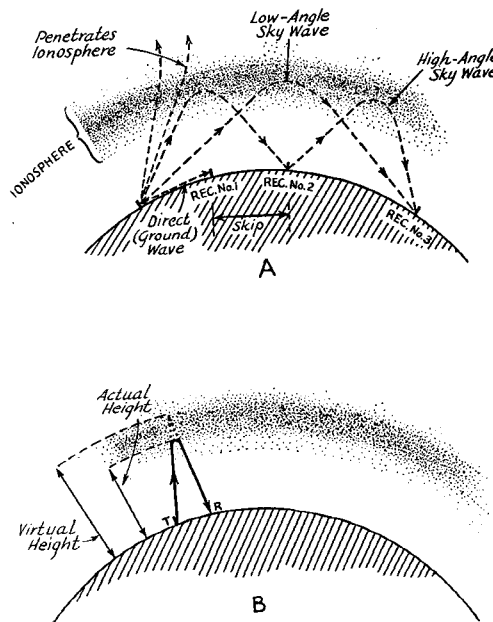

FIG. 417 — ILLUSTRATING GROUND-WAVE AND SKY-WAVE TRANSMISSION OF RADIO WAVES  
The density of the dots indicates that the electron density in the ionosphere increases and then decreases as the altitude becomes greater.

lected and refracted. Reflection occurs when the wave strikes a conductor, such as a wire. A current is consequently set up in the wire, which causes the wire to radiate an electromagnetic wave of its own. If the reflector wire is placed near to the antenna giving the primary radiation, the radiation from the reflector may be made to cancel that from the primary antenna in the direction toward the reflector. Practical use of such reflection is described in Chapters Fourteen and Sixteen. Reflection also can occur in the upper atmosphere, as described in the following paragraphs.

## Radio Waves in Space

Radio waves not only travel along the surface of the earth in the more or less dependable lower atmosphere, for short-distance communication; they also travel through the upper regions far above the earth in the highly variable *ionosphere*, for long-distance communication.

The general idea of the paths followed by radio waves for both direct-ray and indirect-ray communication is illustrated in Fig. 417-A. As would be expected, a direct ray travels out from the transmitter along the surface of the earth and will be received strongly at a relatively near-by point. This part of the radiation is commonly called the *ground wave*. But it is rapidly weakened or *attenuated* as it progresses, until finally it is no longer of useful strength. Moreover, the rapidity with which the ground wave is attenuated is greater as its frequency is higher (or as its wavelength is shorter). This is shown by the "ground wave" curve of Fig. 418. The short-distance nature of this direct wave is apparent.

But not all the energy radiated by the antenna is in waves along the surface. The greater part is likely to be at angles considerably above the horizontal, in fact. These higher-angle *sky waves*, however, would travel on outward into space indefinitely, and would be of no practical use for our communication, if they were not bent back to earth again. Just such bending is what makes our long-distance communication possible. This bending action is explained by the existence of a region of ionized atmosphere, known as the *ionosphere*, surrounding the earth. The possibility of radio waves being returned from such an ionized region was proposed almost simultaneously by A. E. Kennelly in America and by Oliver Heaviside in England in 1902, many years before long-distance short-wave communication demonstrated its proof. In honor

of these two scientists, the ionosphere has been long known also as the *Kennelly-Heaviside layer*. The ionosphere is not strictly a single layer, however. Dr. Kennelly suggested this in his original proposal and more recent investigations have shown that there are several virtual layer heights, as will be explained in the following paragraphs.

## How Sky Waves Are Bent by Refraction

● The ionization of air molecules mentioned above is the result of bombardment by cosmic and solar radiation. As has been previously

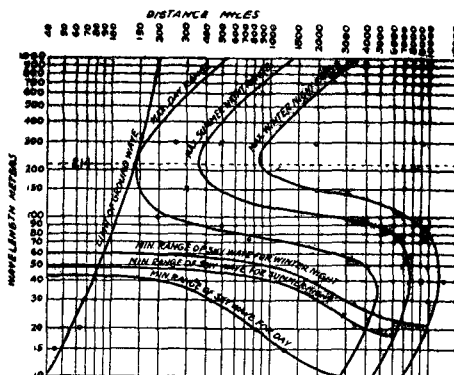

FIG. 418 — APPROXIMATE AVERAGE TRANSMISSION PERFORMANCE OF DIFFERENT WAVELENGTHS AT DIFFERENT DISTANCES

The received signal is assumed to have a field-strength of 10 microvolts per meter at the receiving point. The transmitter is assumed to have 5000 watts in the antenna. The chart is explained as follows. To the left of the line marked "limit of ground wave" it should be possible to receive at all times. After that, one must pick a pair of curves of the same sort (that is for the same time) and if the distance is between the curves one should hear the signal. Thus, a 30-meter wave should be reliable at all times to 70 miles for the conditions mentioned. From there to 400 miles its daylight performance will probably be uncertain while from 400 on it will gradually die down until at 4600 it will again be below 10 microvolts per meter. There are, of course, numerous exceptions where one does hear the signal when it should be absent. The curves are based on skip-distance observations, mainly from data by A. H. Taylor.

pointed out, such ionization by collision makes free electrons and positive ions. These continuously recombine into neutral molecules as other molecules are ionized, then recombine, and so on. This ionization is inappreciable in the air near the earth's surface, to which the ionizing radiations penetrate to only a slight extent and in which the electrons and ions recombine so quickly as to permit the electrons practically no free path. It is considerable in the thin atmosphere at heights



## . . . . *Radio Circuit and Wave Fundamentals*

extending between approximately 40 and 250 miles (70 to 400 kilometers). It is the presence of the free electrons resulting from ionization in this region, and the relatively long free path there allowed the electron before recombination, which is principally responsible for bending of the sky waves.

For the amateur frequencies between 7000 kc. (40-meter band) and 30,000 kc. (10-meter band), the bending is practically all *refraction*. That is, a wave entering the increasingly ionized region from the lower atmosphere has its velocity increased by the increased conductivity due to the presence of the free electrons, and more or less gradually has its course turned away from the ionized region, back towards the earth. One way of visualizing this is to consider the wave as two adjacent rays, one above the other. The upper ray travels faster than the lower ray as it progresses into the ionosphere because it is in the denser electron atmosphere. Hence, it tends to gain on the lower ray, with the consequence that the path of the wave is curved downward to earth — somewhat as the left wheel of a vehicle turning faster than the right will cause a change of direction to the right. A suggestion of this refracting action is given for sky waves in Fig. 417.

### Skip Distance

● The sharpness with which this bending occurs is the greater as the frequency of the wave is lower. At 3500 kc. (80-meter band) and lower frequencies the sky wave usually will return quite close to the transmitting point, within the range covered by the ground wave, as well as at greater distances. At 7000 kc., however, the sky wave usually will not return this close to the transmitter, and there will be a zone of silence from the farther limit of the ground wave to the closest point at which the sky wave returns. This no-signal interval is known as the *skip distance*, from the fact that the signals seem to skip over. The skip distance increases with frequency, as indicated by the curves of Fig. 418, until at frequencies in the 28-mc. (10-meter) band it becomes so great that the returning signal is likely to miss the earth and not to be heard under ionosphere conditions prevailing most of the time.

### Layer Height

● When the skip distance becomes so short that the sky wave returns literally at the transmitting point, the effect is that of *reflection*. This occurs commonly at frequencies in the 3500-kc. band and generally in the 1750-kc. (160-meter) band and on lower frequencies. Of

course less-sharp refraction is also probable at these frequencies, for waves radiated at lower angles than the vertical and striking the ionosphere at angles correspondingly smaller than 90 degrees. Such effective reflection has made possible determination of the effective ionosphere layer heights by direct measurement of the difference in time between receipt of the direct wave from a transmitter and receipt of the sky wave which has traveled up to the ionosphere and back. Assuming the velocity to be 186,000 miles per second, the height is directly proportional to the time difference. This gives what is called the *virtual height*, or the height the wave would reach if it were completely reflected by a perfect reflector. The actual height reached by the wave may be somewhat less than the virtual height as measured. Fig. 417-B illustrates the difference between the two. At present the only height which can be measured experimentally is the virtual height, of course.

These measurements have shown that there are three layers of a major nature, with others occasionally making an appearance. The three are called the *E layer*, the *F<sub>1</sub> layer* and the *F<sub>2</sub> layer*. Measurements made at Washington, D. C., by the U. S. Bureau of Standards on frequencies between 2500 and 4400 kc. show that the *E* layer has a virtual height of approximately 70 miles for the lower frequencies in this range during daytime. At mid-frequencies the waves penetrate this layer and are returned from the *F<sub>1</sub>* layer at a height of approximately 125 miles. At the higher frequencies (towards 4000 kc.) the waves penetrate both the *E* and *F<sub>1</sub>* layers and are returned from the *F<sub>2</sub>* layer at a height of approximately 180 miles. Towards evening the *F<sub>1</sub>* and *F<sub>2</sub>* layers appear to merge, leaving only the one layer in the *F* region at a virtual height of approximately 150 miles or higher during the night. At this time the *E* layer becomes increasingly unable to reflect even the lower frequency (2500 kc.) in this range, as the ionization in this region decreases. Later at night even the *F* layer becomes less able to give direct reflection, so that the frequencies around 4000 kc. penetrate it so far as reflection is concerned. Occasionally it will not reflect the lower frequency, either.

From this it is evident that the layer principally effective for long-distance communication at night is the *F* layer, while any one of the three may be effective for indirect sky-wave transmission during the daytime, depending on the frequency and degree of ionization. It must be remembered, however, that these height figures are mean averages and may vary

# The Radio Amateur's Handbook . . . . .

widely as ionization conditions change with seasons, and as variations in solar radiation accompany different degrees of sunspot activity.

## Angle of Radiation

● An important practical lesson to be learned from these peculiarities of radio wave travel is that transmission will be most effective when the energy radiated from the antenna is concentrated on the ionosphere at an angle which will put the best signal down at the receiving point. For long distance communication this means that the transmitting antenna should concentrate the energy more nearly horizontal than vertical. That is, *low-angle* radiation is preferable, especially on the 7- and 14-mc. bands where radiation at angles below approximately 20 degrees is desirable. Certain types of antennas are more suitable for giving low-angle radiation than others, as shown in Chapter Sixteen. Lower-frequency transmission for intermediate distances may be better suited by higher-angle radiation, however, something like 45 degrees being considered more generally satisfactory for frequencies in the 3500-kc. band.

Another practical point should be mentioned with reference to the receiving antenna and polarization of the waves. On the 7- and 14-mc. band frequencies it has been found that the sky waves arrive at the receiving point with horizontal polarization, irrespective of how they were polarized at transmission. It is thought that this "ironing out" of the polarization occurs when the wave is refracted in the ionosphere, perhaps also as the result of influence of the ground near the receiving antenna. For this reason a horizontal receiving antenna is generally preferable. Also, it appears that most local electrical interference (from machines, etc.) is vertically polarized. The horizontal antenna therefore discriminates against such interfering waves and further aids reception.

## Ultra-High Frequency Waves

● Although waves of ultra-high frequency (above 30 mc.) are only rarely bent back to earth by the ionosphere, recent studies in reception of 56-mc. transmissions over distances of 100 miles or so, which are greater than the ground wave or optical range, have shown evidence of bending in the lower atmosphere. Investigations by the A.R.R.L. technical staff during 1934 and 1935 show that this bending accompanies the presence below 10,000-foot altitude of warmer air layers over cooler surface air, or that it accompanies the occurrence of temperature inversions in the lower atmosphere. Apparently there is cause for suffi-

cient refraction at 56 mc., and at 112 mc., to give "air-wave" communication at distances greater than would be possible with only ground wave transmission. Communication on these frequencies is treated more fully in Chapters Thirteen and Fourteen.

## Fading

● Whenever radio waves can travel between the transmitting and receiving points over more than one path, there is opportunity for simultaneously transmitted oscillations to arrive at the receiver at slightly different times, since one path is likely to be longer than the other. This is especially so when the short-distance ground wave and the longer-path up-and-down sky wave are simultaneously received, or when two sky-wave paths differ as shown in Fig. 417-A. As a result of this time difference, there will be a difference in phase. As we saw in Chapter Three, two voltages of different phase but of the same frequency will augment or cancel each other in effect when detected. Such action is the cause of what is known as *fading* in radio reception. The two paths may not have a constant difference, because there are continuously changing ionization conditions in the upper atmosphere for high frequencies (and of temperature conditions in the lower atmosphere for ultra-high frequencies). Therefore the phase difference between the two sets of waves will shift from instant to instant, causing more or less rapid fluctuations in the effective received signal. The difference in path lengths does not have to vary much to give this effect, since a phase change of 180 degrees would make the difference between inphase aiding and out-of-phase opposition. That is, the corresponding variation in path length could be only one-half wavelength. Shifting polarization also can cause fading effect, although this does not appear to be so important.

Fading is not always evidenced by a simple variation up and down in the strength of the complete signal, but often has this along with disagreeable distortion or poor quality. The latter effect is known as *selective fading* and results because all the frequency components, in a speech modulated wave for instance, do not differ uniformly in path length, some cancelling more than others.

Many methods of attempting to overcome fading have been devised, such as the use of receiving antennas that respond only to waves arriving over one path, automatic gain control in receivers, diversity reception, and so on. Several of these are described in later chapters in this book.

# 5

## Vacuum Tubes

### OPERATING PRINCIPLES—TYPES OF AMPLIFIERS— RECTIFIERS—TUBE TYPE DATA

IT CAN be truthfully said that the art of radio communication as now practiced is based fundamentally upon the vacuum tube. The vacuum tube works to change alternating to direct current in our power supplies, to amplify sound from a whisper to a roar, to generate the radio-frequency power used in transmission and to amplify and detect weak radio waves in our receivers. Vacuum tubes appear in many sizes and in a variety of structures, but all operate on the same principle. Most commonly, the vacuum tube has a glass bulb from which practically all air and other gas has been removed, and within which there are two or more elements, ranging from a filament (cathode) and plate (anode) on up to these two in combination with three, four and even more elements.

The simplest type of vacuum tube is that shown in Fig. 501. It has but two elements, cathode and plate, and is therefore called a *diode*. As was explained in Chapter Three, the hot cathode emits electrons which flow from cathode to plate within the tube when the plate is positive with respect to the cathode. The tube is a conductor in one direction only. If there should be a battery connected with its negative terminal to cathode and positive to plate (the "B" battery in Fig. 501) this flow of electrons would be continuous. But if a source of alternating current is connected between the cathode and plate, then electrons will flow only on the positive half-cycles of alternating voltage. There will be no electron flow, and hence no current flow, during the half cycle when the plate is negative. Thus the tube can be used as a *rectifier*, to change alternating current to pulsating direct current. This alternating current can be anything from the 60-cycle kind to the highest radio frequencies, making it possible to use the diode as a rectifier in power supplies furnishing direct current for our transmitters and receivers, as described in Chapter Fifteen, or even to use it as a rectifier (detector) of radio-frequency current in receivers.

#### Characteristic Curves — Space Charge

● The performance of the tube can be reduced to easily-understood terms by making use of what are known as *tube characteristic curves*. A typical characteristic curve for a diode is shown at the right in Fig. 501. A characteristic curve is one which shows the currents flowing between the various tube elements and cathode (usually only between plate and cathode, since the plate current is of chief interest in determining the output of the tube) with different d.c. voltages applied to the elements. The curve of Fig. 501 shows that, with fixed cathode temperature, the plate current increases as the voltage between cathode and plate is raised. For an actual tube the values of plate current and plate voltage would be plotted along their respective axes.

With the cathode temperature fixed, the total number of electrons emitted is always the same regardless of the plate voltage. The sample curve of Fig. 501 shows, however, that despite the fact that the same number of electrons always is available, less plate current

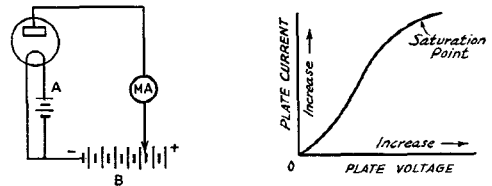

FIG. 501 — THE DIODE OR TWO-ELEMENT TUBE AND A TYPICAL CHARACTERISTIC CURVE

will flow at low plate voltages than when the plate voltage is large. The reason for this is that the electrons emitted from the cathode form a "cloud" between cathode and plate, much the larger proportion of them occupying the space immediately surrounding the cathode. With low plate voltage only those electrons nearest the plate are attracted to the plate. The electrons in the space near the cathode, being

themselves negatively charged, tend to repel the similarly charged electrons leaving the cathode surface and cause them to fall back on the cathode. The repulsion of electrons by the electron cloud is called the *space charge* effect. As the plate voltage is raised, more and more electrons are attracted to the plate until finally the space charge effect is completely overcome and all the electrons emitted by the cathode are attracted to the plate. When this point is reached a further increase in plate voltage can cause no increase in plate current, as shown by the flattening of the characteristic. The point at which all electrons are attracted to the plate is called the *saturation point*.

**How Vacuum Tubes Amplify —  
Tube Characteristics**

● If a third element, called the *control grid* or simply the *grid*, is inserted between the cathode and plate of the diode the space-charge effect can be controlled. The tube then becomes a *triode* (three-element tube) and acquires utility for more things than rectification. The grid is usually in the form of an open spiral or mesh of fine wire. With the grid connected externally to the cathode and with a steady voltage from a d.c. supply applied between the cathode and plate (the positive of the plate of "B" supply is always connected to the plate), there will be a constant flow of electrons from cathode to plate, through the openings of the grid, much as in the diode. But if a source of variable voltage is connected between the grid and cathode there will be a variation in the flow of electrons from cathode to plate (a variation in plate current) as the voltage on the grid changes about a mean value. When the grid is made less negative (more positive) with respect to the cathode the space charge is partially neutralized and there will be an increase in plate current; when the grid is made more negative with respect to the cathode the space charge is reinforced and there will be a decrease in plate current. The important thing about this is that when a resistance or impedance is connected in the plate circuit, the variation in plate current will cause a variation in voltage across this load that will be a magnified version of the variation in grid voltage. In other words there is *amplification* and the tube is an *amplifier*.

The measure of the amplification of which a tube is capable is known as its *amplification factor*, designated by  $\mu$  (mu), an important *tube characteristic*. The amplification factor is the ratio of plate-voltage change required for a given change in plate current to the grid-voltage change necessary to produce the same

change in plate current. Another important characteristic involving plate current change caused by grid voltage change over a very small range is a tube's *mutual conductance*, designated by  $g_m$  and expressed either in milliamperes plate current change per volt grid voltage change (ma. per volt), or as the current to voltage ratio in *mhos* (inverse of ohms).

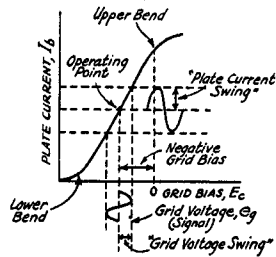

FIG. 502 — OPERATING CHARACTERISTICS OF A VACUUM-TUBE AMPLIFIER  
Class-A amplifier operation is depicted.

Since the plate current changes involved are often very small, the mutual conductance is also expressed in *micromhos*, the ratio of amperes plate current change to volts grid voltage change, multiplied by one million. Still another important characteristic used in describing the properties of a tube is the *plate resistance*, designated  $r_p$ . This is the ratio of a small plate voltage change to the plate current change it effects. It is expressed in *ohms*. These tube characteristics are inter-related and are different with tubes of different types, being dependent primarily on the tube structure (spacing between elements, spacing and size of wires in grid, etc.).

**Amplifier Operation**

● The operation of a vacuum tube amplifier is graphically represented in Fig. 502. The sloping line represents the variation in plate current obtained at a constant plate voltage with grid voltages from a value sufficiently negative to reduce the plate current to zero to a value slightly positive. It should be kept in mind that grid voltage is with reference to the cathode or filament. This is known as the *static grid-voltage plate-current characteristic*. Notable things about this curve are that it is essentially a straight line (is *linear*) over the middle section and that it bends towards the bottom (near *cut off*) and near the top (*saturation*). In other words, the variation in plate current is directly proportional to the variation in grid voltage over the region between the two bends. With a fixed grid voltage (*bias*) of proper value

the plate current can be set at any desired value in the range of the curve.

With negative grid bias as shown in Fig. 502 this point (the *operating point*) comes in the middle of the linear region. If an alternating voltage (*signal*) is now applied to the grid in series with the grid bias, the grid voltage swings more and less negative about the mean bias voltage value and the plate current swings up (positive) and down (negative) about the mean plate current value. This is equivalent to an alternating current superimposed on the steady plate current. With this operating point it is evident that the plate current *wave shapes* are identical reproductions of the grid voltage wave shapes and will remain so long as the grid voltage amplitude does not reach values sufficient to run into the lower- or upper-bend regions of the curve. If this occurs the output waves will be flattened or be *distorted*. If the

audio-frequency amplifier using a triode is shown in Fig. 503. The alternating grid voltage is applied through the transformer  $T_1$  to the grid circuit, in series with negative grid bias furnished by a battery. The a.c. component of the plate current induces an alternating voltage in the secondary of the output transformer,  $T_2$ . This output might go on to another similar audio amplifier for further amplification. In lieu of the output transformer, a pair of 'phones could be connected in place of the primary in the plate circuit, in which case the alternating component of the plate current would be reproduced immediately as sound.

### Static and Dynamic Characteristics

● A tube characteristic of the type shown in Fig. 502 is meaningless for design purposes unless certain operating conditions not shown by the curve itself are specified. For instance, if the curve illustrated is a *static characteristic*, it will show only the plate current that will flow at specified plate and grid voltages in the absence of any output device or load in the plate circuit. Fig. 504-A illustrates a sample static characteristic and indicates the method by which the data are obtained. With the plate voltage  $E_b$  fixed, the grid voltage  $E_g$  is varied, plate current readings being taken for each change in grid voltage. A complete series of readings will give one of the curves at the left. Several of these may be taken with a number of different plate voltage values. Since the path for the flow of plate current consists only of the plate battery and the plate-cathode circuit of the

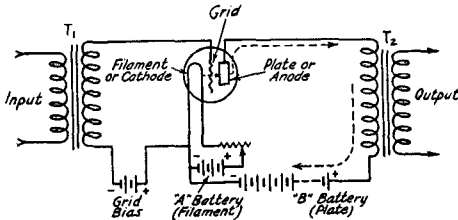

FIG. 503—A TYPICAL AUDIO-FREQUENCY AMPLIFIER USING A TRIODE TUBE

operating point is set towards the bottom or towards the top of the curve there will also be distortion of the output wave shapes because part or all of the lower or upper half-cycles will be cut off. This kind of distortion may be undesirable or desirable, as will be shown later.

The major uses of vacuum tube amplifiers in radio work are to amplify at audio frequencies (approximately 30 to 15,000 cycles per second) and to amplify at radio frequencies (up to 60,000 kc. or higher). The audio-frequency amplifier is generally used to amplify without discrimination at all frequencies in a considerable range (say from 100 to 3000 cycles for voice communication), and is therefore associated with non-resonant or untuned circuits. The radio-frequency amplifier, on the other hand, is generally used to amplify selectively at a single radio frequency, or over a small band of frequencies at most, and is therefore associated with resonant circuits tunable to the desired frequency.

The circuit arrangement of a typical

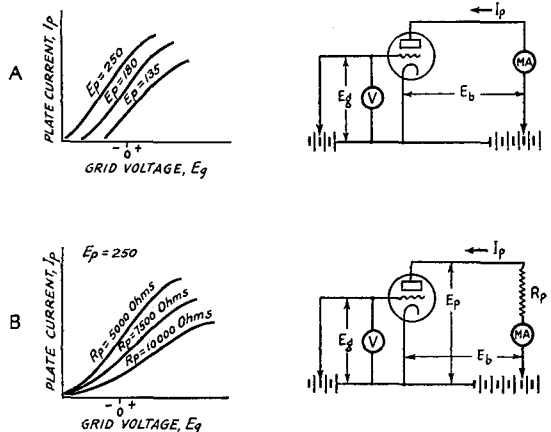

FIG. 504—STATIC (A) AND DYNAMIC (B) CHARACTERISTICS

*The values shown on the curves are purely arbitrary, and are used simply to illustrate the relative behavior with different applied voltages or with different load impedances.*

the tube itself, it is plain that no provision has been made for transferring the plate current variations with signal input, illustrated in Fig. 502, to an external circuit. Obviously the utility of such a characteristic is limited.

A more useful type of curve is the *dynamic characteristic*, illustrated in Fig. 504-B. In plotting this form of curve a resistance,  $R_p$ , is connected in series with the battery and plate-cathode circuit of the tube; it represents a *load* or output circuit. Plate current flowing through  $R_p$  causes a voltage drop in the resistor; if the grid voltage is varied, causing a variation in plate current, the voltage drop across  $R_p$  likewise will vary. If an alternating voltage is applied to the grid-cathode circuit the alternating plate current causes an alternating voltage to be developed across the terminals of  $R_p$ ; this voltage is the useful output of the tube.

The *load impedance* or *load resistance*,  $R_p$ , may be an actual resistor or may be a device such as a headset or loud-speaker having a self-impedance, at the frequency being amplified, of a value suitable to be connected in the plate circuit of the tube. In general, there will be one value of  $R_p$  which will give optimum results for a given type of tube and set of operating voltages; its value also depends upon the type of service for which the amplifier is designed. If the impedance of the actual device used is considerably different from the optimum load impedance, the tube and output device must be coupled through a transformer having a turns ratio such that the impedance reflected into the plate circuit of the tube is the optimum value. Several different values of load impedance may be used in making up a set of dynamic characteristics, as shown in Fig. 504-B, giving the designer a choice of several values.

In making up a characteristic of this type, the plate battery voltage,  $E_b$ , usually is chosen so that the voltage actually operating between plate and cathode,  $E_p$ , is the rated value for the tube at the normal operating plate current.  $E_b$  must therefore equal the sum of  $E_p$  plus the drop through  $R_p$  at rated plate current. To illustrate, suppose the tube is rated at 250 volts and 30 milliamperes plate, and the load impedance is 5000 ohms. The voltage drop in  $R_p$  is  $5000 \times 0.03$ , or 150 volts,  $E_p$  is 250 volts;  $E_b = 150 + 250$ , or 400 volts. If the grid bias is made more negative, the plate current will decrease and the drop in  $R_p$  also will decrease, leaving more voltage effective at the plate itself. If the grid bias is made more positive with respect to the cathode, the converse will be true. The limit in the negative-grid

direction would be the cut-off grid voltage, when the plate current would be zero, the drop in  $R_p$  likewise zero, and  $E_p$  would equal  $E_b$ , or 400 volts. The limit in the positive-grid direction would be reached at saturation, when the plate current is maximum, the drop in  $R_p$  also is maximum, and the plate voltage,  $E_p$ , reaches its lowest value. When the grid voltage is high (positive) the plate voltage is low (negative swing of a.c. component). The alternating components of the grid and plate voltages are therefore opposite in phase, or  $180^\circ$  out of phase.

If the load has high a.c. impedance but low d.c. resistance,  $E_b$  may equal  $E_p$  at normal grid voltage and plate current, since in the absence of signal the d.c. drop through the load will be small. The increase and decrease of plate voltage with changing grid voltage then comes about because of the reactive voltage developed in the impedance. For example, if the load is assumed to have an a.c. impedance of 5000 ohms but negligible d.c. resistance, the battery voltage  $E_b$  in our previous example would be 250 instead of 400 volts, the whole 250 volts being effective at the plate under no-signal conditions. When a signal of suitable amplitude is applied to the grid, the plate voltage would swing between the same values as before, reaching a peak of 400 volts at cut off, even though the supply voltage is only 250, because of the reactive voltage induced in the load. This would occur only when an alternating voltage is applied to the grid, how-

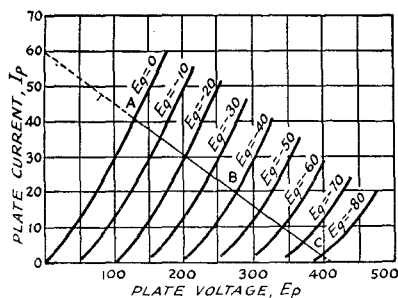

FIG. 505 — A TYPICAL "PLATE FAMILY," SHOWING THE METHOD OF DRAWING A LOAD LINE

ever, and could not be reproduced with fixed values of grid voltage.

### The Plate Characteristic Family

● The type of characteristic shown in Fig. 504-B is somewhat inconvenient to use because a separate curve must be plotted for each value of load impedance considered. A more general type of characteristic, known as the

plate-voltage plate-current type, or commonly called the *plate family*, is shown in Fig. 505. In this characteristic, plate voltage is plotted against plate current for different fixed values of grid voltage throughout the usable range for the tube. The load impedance on such a characteristic can be represented by a line drawn through the operating point chosen, as shown. The impedance represented by the line is determined by its slope; if the line is extended so that it intersects both the vertical and horizontal reference lines, the plate voltage at the point of intersection divided by the plate current at its point of intersection will be the impedance. In the drawing these values are 420 volts and 60 milliamperes, giving an impedance of  $420/.06$ , or 7000 ohms.

The voltage developed across the load and the value of alternating plate current can be found from the points of intersection of the load line with the various grid voltage values. For instance, if the peak grid voltage swing about the operating point, B, is 20 volts, the peak positive grid voltage will be  $40 - 20$ , or 20 volts, and the peak negative voltage will be  $40 + 20$ , or 60 volts. The plate voltage and plate current at  $E_g = -20$  volts are 200 volts and 30 ma. respectively; at  $E_g = -60$  volts, 340 volts and 10 ma. The plate voltage swing is therefore  $340 - 200$  volts/2, or 70 volts (it is necessary to divide by 2 because the two values so obtained are the extremes of the positive and negative — or “up” and “down” — swings, while an alternating voltage is measured with respect to the zero point, which is the operating point in this case). Similarly, the plate current swing is  $30 \text{ ma.} - 10 \text{ ma.}/2$ , or 10 ma.

In the figure, if it is assumed that the grid voltage is not to go beyond zero in the positive direction, the maximum grid voltage swing from the bias of 40 volts would likewise be 40 volts. It is evident that the maximum total output voltage and current swings under the assumed operating conditions would then be  $394 - 130$  volts and  $41 - 2$  milliamperes. The *power output* of the tube is then equal to these two values multiplied together and divided by 8, or

$$PO = \frac{(E_{pmax.} - E_{pmin.}) \times (I_{pmax.} - I_{pmin.})}{8}$$

In our example, the power output would be  $265 \times .039/8$ , or 1.3 watts, approximately.

### Distortion — Harmonics

● If the output wave shape is not an exact reproduction of the signal applied to the grid-cathode circuit, the wave-shape is said to be

*distorted*, as already described. It can be shown that any periodic wave, regardless of its shape, can be resolved into a number of simple sine waves of various amplitudes and phase relationships, but all in harmonic frequency relationship. The term “harmonic” already has been explained in Chapter Three. If the exciting signal is a sine wave, the output wave, when distortion is present, will consist of a fundamental plus second and higher harmonics. In triode amplifiers the second harmonic is the one of most importance.

It has been found by listening tests that the presence of a second harmonic having an amplitude as high as 5% of the fundamental amplitude is undetectable aurally. The greater the harmonic content tolerable in the output, the greater is the permissible voltage or power output of the tube. For this reason triode power amplifiers usually are given an output rating based on the presence of a second harmonic having 5% of the amplitude of the fundamental rather than on the lowest distortion obtainable; commonly, the output is said to have 5% distortion. This means that, considering Fig. 504-B, the load resistance and grid swing are chosen so that a small part of the curved portion of the characteristic is used. Similarly, in Fig. 505 the up-voltage swing along the load line may be smaller than the down swing, the difference, if any, between these two values representing distortion. If the up-swing (to the right along the load line) is not less than 9/11ths of the down swing, the distortion will not exceed 5%.

The load line shown in Fig. 505 represents 5% distortion, because with a peak grid swing of 40 volts on either side of the operating point, the length of line BA is 11/9ths of line BC. As the load resistance is increased by making the slope of the load line less, line BC will approach AB in length and the distortion decreases; conversely a lower load resistance than that shown (greater slope to the load line) will give more than 5% distortion.

### Parallel and Push-pull Amplifiers

● It is sometimes necessary to obtain more power output than one tube is capable of giving. To do this without going to a larger tube structure, two or more tubes may be connected in *parallel*, in which case the similar elements in all tubes are connected together. When this is done the power output will be in proportion to the number of tubes used; the exciting voltage required, however, is the same as for one tube. Parallel operation of tubes involves certain considerations which will be considered more fully in later chapters. It is

seldom that more than two tubes are connected in parallel because of circuit considerations.

An increase in power output also can be secured by connecting two tubes in *push-pull*, in which the grids and plates of the two tubes are connected to opposite ends of the circuit, respectively. Parallel and push-pull operation are illustrated in Fig. 506. A "balanced" circuit, in which the cathode returns are made to

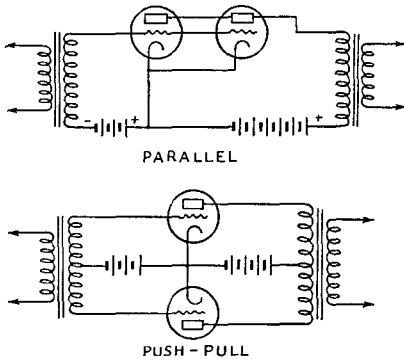

FIG. 506 — PARALLEL AND PUSH-PULL AMPLIFIER CONNECTIONS

the midpoint of the input and output devices, is necessary with push-pull operation. An alternating current flowing through the primary of the input transformer in the push-pull diagram will cause an alternating voltage to be induced in the secondary winding; since the ends of the winding will be at opposite potentials with respect to the cathode connection the grid of one tube is swung positive at the same instant that the grid of the other is swung negative. The plate current of one tube therefore is rising while the plate current of the other is falling, in the same way that the motion of the familiar child's "see-saw" is distributed. Hence the name "push-pull." The power output with two tubes in push-pull is the same as with two tubes in parallel, assuming the same operating conditions, but twice as much exciting voltage is required. However, in push-pull operation the second-harmonic distortion is cancelled in the symmetrical plate circuit, so that for the same output the distortion will be less than with parallel operation. It follows, of course, that for a given degree of distortion, the push-pull amplifier is therefore capable of delivering more power than a parallel amplifier. Only odd harmonics are present in the output of a push-pull amplifier, and since these harmonics are of small amplitude with triode tubes, the power output from a pair of tubes in push-pull can be made considerably greater than with the same

tubes in parallel before distortion becomes objectionable.

**Methods of Coupling**

● In multi-stage amplifiers a variety of coupling methods may be used between stages. Three fundamental forms of coupling are shown in Fig. 507. That at *A* is known as *transformer coupling*, because a transformer is used to convey the signal from the output circuit of the first tube to the input or grid circuit of the second. The grid of the second tube cannot be connected directly to the plate of the first because of the wide difference in their steady d.c. operating potentials. The method shown at *B* is called *resistance coupling*; the output voltage of the first tube is developed across the resistor in its plate circuit and transferred to the grid of the second tube through the coupling condenser *C*, appearing across the resistor in the grid circuit of the second tube. The third method, at *C*, is known as *impedance coupling* because a choke coil is used as the coupling element. There are many variations of these three circuits. The iron-core transformer of *A* may be replaced by a tuned air-core transformer in radio-frequency circuits, the impedance and resistor in *C* may be interchanged, etc. Coupling methods will be considered fully in the following chapters.

**Voltage and Power Amplifiers**

● Amplifiers may be divided broadly into two general types, those whose chief purpose is to

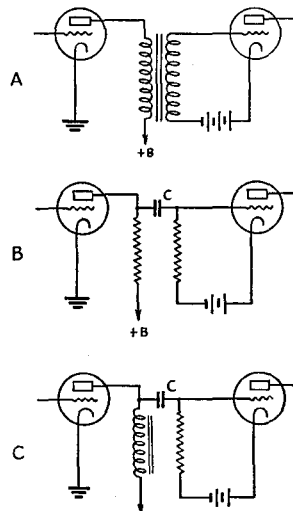

FIG. 507 — METHODS OF COUPLING BETWEEN AMPLIFIER TUBES  
*A*, transformer coupling; *B*, resistance coupling, *C*, impedance-resistance coupling.



give a greatly magnified reproduction of the input signal without regard to the power delivered, and those which are intended to deliver a relatively large amount of power to a load (for example, a loud-speaker, in the case of an audio amplifier, or an antenna, in the case of a radio-frequency amplifier). The former is known as a *voltage amplifier*, while the latter is called a *power amplifier*.

Generally speaking, the last stage of any amplifier, whether audio or radio, is a power amplifier, since power is required for the operation of sound-reproducing devices and for the excitation of antennas. Amplifier stages preceding the last may be either voltage or power amplifiers, depending upon the purpose for which the equipment is designed. In audio circuits, the power tube or output tube in the last stage usually is especially designed to deliver a considerable amount of audio power, while requiring but negligible power from the input or exciting signal. The *power amplification* — ratio of output power to power supplied the grid circuit — is consequently very high. Such tubes generally require a large grid voltage swing for full power output, however, so that the *voltage amplification* — ratio of output voltage to signal voltage — is quite low. Triode audio power amplifiers of this type often will give a power amplification ratio almost infinite, while the voltage amplification ratio may be less than 3 to 1. To get the voltage swing required for the grid circuit of such a power tube it becomes necessary to use voltage amplifiers, employing tubes of high  $\mu$  which will greatly increase the amplitude of the signal. Although such tubes are capable of relatively-high voltage output, the power obtainable from them is small. Voltage amplifiers are used in the radio-frequency stages of receivers as well as in audio amplifiers.

As explained in the preceding sections, the portion of the tube characteristic which can be utilized for distortionless amplification is limited. In radio-frequency circuits, where the input and output circuits are resonant, harmonic distortion of the r.f. wave form often can be neglected, since most of the harmonics so generated are filtered out in the tuned circuits, with the result that the whole tube characteristic can be used. This leads to increased efficiency and higher power output for a given tube capacity. To obtain high efficiency in the plate circuit it is necessary that the grid be driven positive during part of the exciting signal cycle; during the time that the grid is positive with respect to the cathode electrons are attracted to the grid and a flow of grid current results. This in turn requires that the

source of the exciting signal be capable of supplying power. For this reason it is usually found that all the amplifier stages in a transmitter, where high efficiency and maximum power output are desirable, are power stages. The voltage amplification in such a case is secondary. Certain types of high-efficiency audio amplifiers to be discussed later also require some power in the grid input circuit, so that such amplifiers often will be preceded by a smaller power amplifier.

## Amplifier Classifications — Class A Amplifiers

● An amplifier operated as shown in Fig. 502, in which the output wave shape is a faithful reproduction of the input wave shape, is known as a *Class A* amplifier. It is one of three fundamental types of amplifiers, the other two being designated as *Class B* and *Class C*.

Certain operating conditions distinguish the *Class A* amplifier from other types. As most generally used, the grid never is driven positive with respect to the cathode by the exciting signal, and never is driven so far negative that plate-current cut-off is reached. The plate current is constant both with and without an exciting signal. The chief characteristics of the *Class A* amplifier are low distortion, low power output for a given size of tube, and a high power-amplification ratio. The plate efficiency — ratio of a.c. output power to steady d.c. input power — is relatively low, being in the vicinity of 20 to 35 percent at full output, depending upon the design of the tube and the operating conditions.

Specially designed tubes, capable of being excited or driven by voltage amplifiers, are used for *Class-A* power amplification. In general, a relatively large signal is required to drive them to full output, even though no power is consumed in the grid circuit. It should be understood, however, that any tube operated so that the output signal is a distortionless reproduction of the input signal, and whose operating conditions are such that plate current flows during the entire cycle of exciting grid voltage, is a *Class A* amplifier, regardless of whether or not grid current is drawn, and whether the tube is used as a power or voltage amplifier.

*Class A* amplifiers of the power type find their chief application as output amplifiers in audio systems, operating loud speakers in radio receivers and public-address systems, and as modulators in radio telephone transmitters. *Class A* voltage amplifiers are found in the stages preceding the power stage in the same applications, and as radio-frequency amplifiers in receivers.

**Class-B Amplifiers**

● The Class-B amplifier is primarily one in which the output current, or alternating component of the plate current, is proportional to the amplitude of the exciting grid voltage. Since power is proportional to the square of the

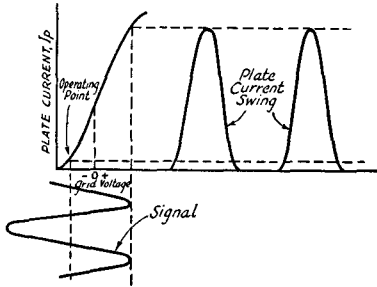

FIG. 508 — OPERATION OF THE CLASS-B AMPLIFIER

current, this can be put in another way by saying that the power output of a Class-B amplifier is proportional to the square of the exciting grid voltage.

The distinguishing operating conditions of Class-B service are that the grid bias is set so that the plate current is very nearly zero or cut-off; the exciting signal amplitude can be such that the entire linear portion of the tube's characteristic is used. Fig. 508 illustrates Class-B operation. Plate current flows only during the positive half-cycle of excitation voltage. Since the plate current is set practically to zero with no excitation, no plate current flows during the negative swing of the excitation voltage. The shape of the plate current pulse is essentially the same as that of the positive swing of the signal voltage. Since the plate current is driven up toward the saturation point, it is usually necessary for the grid to be driven positive with respect to the cathode during part of the grid swing, as indicated on the drawing. Grid current flows, therefore, and the driving source must be capable of furnishing power to supply the grid losses.

Class-B amplifiers are characterized by medium power output, medium plate efficiency (50% to 60% at maximum signal) and a moderate ratio of power amplification.

Class-B amplifiers are used for both audio and radio-frequency amplification. As radio frequency amplifiers they are used as *linear amplifiers* to raise the output power level in radio telephone transmitters after modulation has taken place. For this service it is essential that the output power be proportional to the square of the excitation voltage, which varies

at an audio-frequency rate. The tube can be driven into the upper-bend region of its characteristic, giving some flattening of the plate current pulse at the top, but since the distortion is only present in the radio-frequency wave and not in the audio-frequency modulation, it can be filtered out in the resonant plate circuit.

In transmitters, Class-B r.f. amplifiers often are used where a fairly high power gain is required even though it is not essential that the amplification be linear. With the bias set to cut-off the excitation requirements are not as severe as with the high-efficiency Class-C amplifier.

**Class-B Audio Amplifiers**

● For audio-frequency amplification, two tubes must be used to permit Class-B operation. It is apparent from Fig. 508 that al-

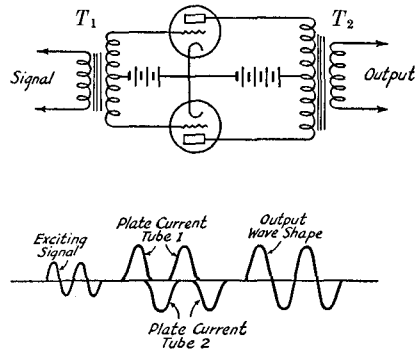

FIG. 509 — THE CLASS-B AUDIO AMPLIFIER, SHOWING HOW THE OUTPUTS OF THE TWO TUBES ARE COMBINED TO GIVE DISTORTION-LESS AMPLIFICATION

though the plate current pulses are of the same shape as the positive signal swing, yet considerable distortion at audio frequencies would be introduced if only one-half of each cycle were present in the output. For this reason a second tube, working alternately with the first, must be included in the amplifier circuit so that both halves of the cycle will be present in the output. A typical method of arranging the tubes and circuit so that this end is achieved is shown in Fig. 509. The circuit resembles that of the push-pull Class-A amplifier; the difference lies in the method of operation. The signal is fed to a transformer  $T_1$  whose secondary is divided into two equal parts, with the tube grids connected to the outer terminals and the grid bias fed in at the center. A transformer  $T_2$  with a similarly-divided primary is connected to the plates of the tubes, the plate voltage

being fed in at the center-tap. When the signal swing in the upper half of  $T_1$  is positive, Tube No. 1 draws plate current while Tube No. 2 is idle; when the lower half of  $T_1$  becomes positive, Tube No. 2 draws plate current while Tube No. 1 is idle. The corresponding voltages induced in the halves of the primary of  $T_2$  combine in the secondary to produce an amplified reproduction of the signal wave-shape with negligible distortion. The Class-B amplifier is capable of delivering much more power output, for a given tube size, than is obtainable from a Class-A amplifier. In contrast to the Class-A amplifier with its steady plate current, the average plate current drawn by the Class-B audio amplifier is proportional to the amplitude of the exciting voltage. Tubes most suitable for Class-B audio service are generally those with high  $\mu$ 's, for reasons to be discussed in a later chapter in connection with the design of Class-B modulators.

**Class-C Amplifiers**

● The third type of amplifier is that designated as Class-C. Fundamentally, the Class-C amplifier is one operated so that the alternating component of the plate current is directly proportional to the plate voltage. The output

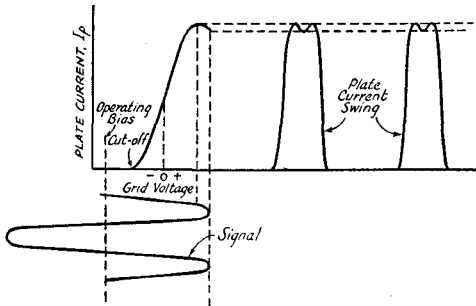

FIG. 510 — CLASS-C AMPLIFIER OPERATION

power is therefore proportional to the square of the plate voltage. An amplifier so operated is capable of being modulated linearly by plate voltage variation, as will be described in Chapter Eleven. Other characteristics inherent to Class-C operation are high plate efficiency, high power output, and a relatively low power-amplification ratio.

The grid bias for a Class-C amplifier is ordinarily set at approximately twice the value required for plate current cut-off without grid excitation. As a result, plate current flows during only a fraction of the positive excitation cycle. The exciting signal should be of sufficient amplitude to drive the plate current to the saturation point, as shown in Fig. 510.

Since the grid must be driven far into the positive region to cause saturation, considerable numbers of electrons are attracted to the grid at the peak of the cycle, robbing the plate of some that it would normally attract. This causes the droop at the upper bend of the characteristic, and also causes the plate current pulse to be indented at the top, as shown. Although the output wave-form is badly distorted, at radio frequencies the distortion is largely eliminated by the filtering or flywheel effect of the tuned output circuit.

Class-C amplifiers are used principally as radio-frequency power amplifiers, since the Class-C type of operation has very little audio-frequency application. Although requiring considerable driving power because of the relatively large grid swing and grid-current flow, the high plate efficiency of the Class-C amplifier makes it an effective generator of radio-frequency power.

**Other Amplifier Classifications**

● Since the three fundamental amplifier classifications represent three distinct steps in the operation of vacuum tubes, it naturally becomes possible to adopt a set of operating conditions which partakes of the nature of two of the classifications although not adhering strictly to either. Such "midway" methods of operation can be classified as "AB" and "BC". Only the "AB" type of operation is in general use. The Class-AB amplifier is a push-pull amplifier in which each tube operates during more than half but less than all the exciting-voltage cycle. Its bias is set so that the tubes draw more plate current than in Class-B operation, but less than they would for Class-A. The plate current of the amplifier varies with the signal voltage, but not to as great an extent as in Class-B operation. The Class-AB amplifier is also occasionally called Class-A Prime.

The efficiency and output of the Class-AB amplifier lie between those obtainable with pure Class-A or Class-B operation. Class-AB amplifiers tend to operate Class-A with low signal voltages and Class-B with high signal voltages, thus overcoming the chief objection to Class-B operation — the distortion present with low-input-signal voltages. The Class-AB amplifier is widely used where it is necessary to obtain a power output of considerable magnitude with a minimum of distortion.

**Harmonic Generation**

● It has been stated that distortion is equivalent to combining the original wave shape with one or more harmonics of the fundamental

frequency. Although harmonic generation is undesirable in audio amplifiers, it has a very important place in radio-frequency amplification, as we shall see in the chapters on transmitters. Hence it is advantageous in some applications to adjust the tube operating conditions so that the output wave shape is greatly

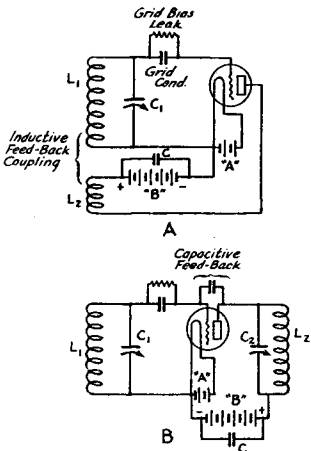

FIG. 511 — TWO GENERAL TYPES OF OSCILLATOR CIRCUITS

distorted. High input-signal amplitude or grid swing and high negative bias are favorable to the production of harmonics, as is evident from study of Fig. 510 in comparison with Figs. 508 and 502. By proper choice of operating conditions and tuning the output circuit to the desired harmonic frequency, a vacuum tube may be operated as a frequency doubler or frequency tripler, etc. Harmonics cannot be generated at frequencies below the fundamental but always occur at higher frequencies.

### Generating Radio Frequency Power — Oscillators

● Because of its ability to amplify, the vacuum tube can oscillate, or generate alternating current power. To make it do this, it is only necessary to couple the plate (output) circuit to the grid (input) circuit so that the alternating voltage supplied to the grid of the tube is opposite in phase to the voltage on the plate. Typical circuits for this condition are shown in Fig. 511. In A the feed-back coupling between the grid and plate circuits is inductive (by means of coils), while in B the coupling is capacitive (through a condenser). In the circuit of A the frequency of oscillation will be very nearly the resonant frequency of the tuned circuit  $L_1C_1$ , while in B the frequency of oscillation will be determined jointly by  $L_1C_1$

and  $L_2C_2$ . To insure the proper phase relationship between plate and grid voltage, with the inductive feed-back of A the grid and plate should be connected to the opposite ends of the plate and grid coils when these coils are wound in the same direction, while in the arrangement of B the plate circuit should be tuned to a slightly higher resonant frequency than the grid circuit (plate circuit reactance inductive with respect to the grid circuit). At the high radio frequencies used in amateur work the inherent plate-grid capacitance of the usual triode tube is sufficient for feed-back in the tuned-grid tuned-plate type circuit of B, so the feed-back condenser shown connected between grid and plate is not necessary.

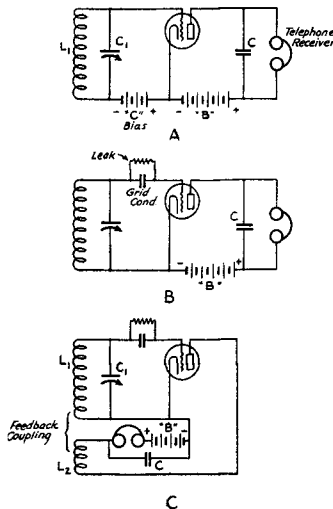

FIG. 512 — DETECTOR CIRCUITS OF THREE TYPES

A, plate detection; B, grid detection; C, Regenerative grid detection.

There are many other arrangements of oscillator circuits but all utilize either the inductive or capacitive feed-back typified in the two shown here. Several of these other types are treated in Chapter Eight. A special type of oscillator of exceptional frequency stability is the piezo-electric or crystal-controlled type. Most commonly it resembles the tuned-grid tuned-plate circuit of B with the exception that the tuned grid circuit is replaced by a plate of quartz crystal mounted between metal electrodes. This crystal acts like a tuned circuit, its electrical equivalent being shown in Chapter Four.

Power type oscillators and amplifiers are used in combination in radio transmitters, both for radiotelegraphy and radiotelephony, and

later chapters will describe practical aspects of these applications.

## Detection

● Since the frequencies used in radio transmission are much higher than those audible to the ear, it is necessary to provide a means for making the signals intelligible. The process for doing this is called *detection* or *demodulation* — the latter because the modulation envelope is in effect detached from the carrier wave and made audible. Taking the case of a modulated wave, such as a radiotelephone transmission, we find there are three ways of operating tubes to perform the function of demodulation. All are essentially the process of *rectification*, in which the radio-frequency input is converted into direct current which in turn varies in accordance with the audio-frequency modulation envelope. The first type of detector is the diode, or simple rectifier, the operation of which already has been explained. Multi-element tubes can be operated either as “grid” or “plate” detectors, depending upon whether the rectification takes place in the grid circuit or plate circuit.

## Plate Detectors

● The circuit arrangement of a typical plate detector is shown at A of Fig. 512. Its operating characteristics are illustrated at A of Fig. 513. The circuit  $L_1C_1$  is tuned to resonance with the

radio frequency and the voltage developed across it is applied between the grid and cathode in series with the grid-bias battery. A telephone headset (or the primary of a transformer feeding an audio amplifier) is connected in the plate circuit, a small fixed condenser  $C$  being connected across the plate load to bypass radio frequency. As shown at A in Fig. 513, the negative grid bias voltage is such that the operating point is in the lower-bend region of the curve, near cut-off. With a modulated signal as shown there will be a variation in plate current conforming to the average value of the positive half-cycles of radio frequency. This variation corresponds to the envelope, representing an audio-frequency current superimposed on the steady plate current of the tube, and constitutes the useful audio output of the detector. When this pulsating current flows through the 'phones their diaphragms vibrate in accordance with it to give a reproduction of the modulation put on the signal at the transmitter.

It is apparent from the drawing that a carrier signal will cause an increase in the average plate current.

This type of detection is called plate detection because the rectification takes place in the plate circuit after radio-frequency amplification from grid to plate.

## Grid Detectors

● The circuit arrangement of a triode used as a *grid detector* (also called *grid leak detector*) is shown in B of Fig. 512. Here again we have an input circuit tuned to the frequency of the radio wave and connected so that the r.f. voltage developed across it is applied between the grid and cathode. However, there is no fixed negative grid bias, as in the case of the plate detector, but instead a small fixed condenser (*grid condenser*) and resistor of high value (*grid leak*) in parallel are connected between tuned circuit and grid. The plate circuit connections are the same as for the plate detector.

The action of the grid detector is illustrated by the grid voltage — grid current curve of Fig. 510-B. A modulated radio-frequency voltage applied to the grid swings it alternately positive and negative about the operating point. The grid attracts electrons from the cathode, the consequent grid current increasing more during the positive half cycles than it decreases during the negative half cycles of grid swing. Hence there is a rectified grid current flow at modulation frequency whose average value develops a voltage across the grid leak. This audio-frequency variation in voltage across the grid leak causes corresponding varia-

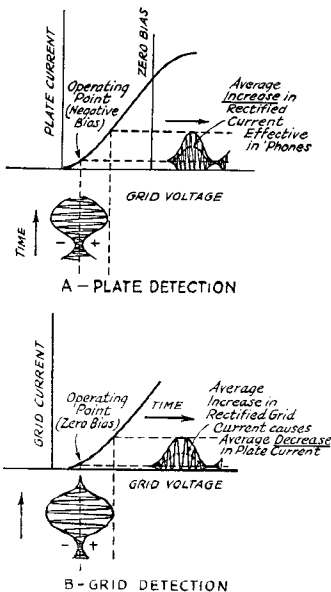

FIG. 513 — OPERATING CHARACTERISTICS OF PLATE AND GRID DETECTORS

tions in plate current which are reproduced in the 'phones. In contrast to plate detection, with grid detection the rectification takes place in the grid circuit and there is audio-frequency

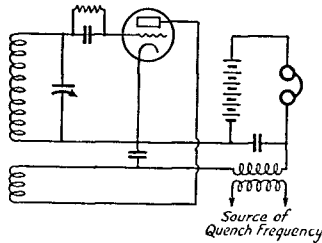

FIG. 514—AN ELEMENTARY SUPERREGENERATIVE CIRCUIT

amplification to the plate circuit. With grid rectification as shown, the increase in grid current when a carrier signal is applied causes an increase in grid voltage in the negative direction, consequently the average plate current of the grid detector decreases when a signal is applied.

Grid detection is generally used in amateur receivers of limited r.f. amplification because grid detectors are capable of greater sensitivity for small signals than plate detectors, using similar tubes. Plate detection is more commonly used where detector sensitivity is of minor importance, since a larger signal can be handled with less distortion than with grid detection.

### Regenerative Detectors

● With both the grid and plate detectors just described it will be noted that a condenser is connected across the plate load circuit to bypass radio-frequency components in the output. This radio-frequency can be fed back into the grid circuit, as shown in *C* of Fig. 512, and re-amplified a number of times. This *regeneration* gives a tremendous increase in detector sensitivity and is used in most amateur receivers. If the regeneration is sufficiently great the circuit will break into oscillation, which would be expected since the circuit arrangement is almost identical with that of the oscillator shown in Fig. 507-A. Therefore a control is necessary so that the detector can be operated either regenerating to give large amplification without oscillation, or to oscillate and regenerate simultaneously. Methods of controlling regeneration are described in Chapter Six.

### Superregeneration

● The limit to which regenerative amplification can be carried is the point at which the

tube starts to oscillate, because when oscillations commence, further regenerative amplification ceases. To overcome this limitation and give still greater amplification, the *superregenerative* circuit has been devised. Essentially, the superregenerative detector is similar to the ordinary regenerative type but with a comparatively low, but super-audible (above audibility) signal introduced in such a way as to vary the detector's operating point at a uniform rate. As a consequence of the introduction of this *quench* or *interruption frequency* the detector can oscillate at the signal frequency only when the moving operating point is in a region suitable for the production of oscillations. Because the oscillations are constantly being interrupted, the signal can build up to relatively tremendous proportions, and the superregenerative detector therefore is extremely sensitive. An elementary form of superregenerative circuit is shown in Fig. 514.

Superregeneration is relatively difficult to attain at ordinary frequencies, and does not possess the property of discriminating between signals of different frequencies characteristic of other types of detectors — in other words, the selectivity is poor. For this reason the superregenerative circuit finds its chief field in the reception of ultra-high-frequency signals, for which purpose it has proved to be eminently successful.

### Multi-Element Tubes

● So far only tubes with two and three elements have been considered. Other elements may be added to the structure to make a tube particularly suitable for certain specialized applications; likewise two or more sets of elements may be combined in one bulb so that a single tube may be used to perform two or three separate functions.

Tubes having four elements are called *tetrodes*, while if a fifth element is added the tube is known as a *pentode*. Many element

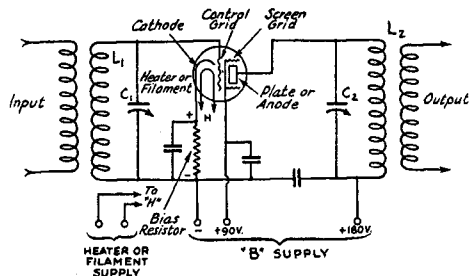

FIG. 515—A TUNED RADIO-FREQUENCY AMPLIFIER CIRCUIT USING A SCREEN-GRID TETRODE

combinations and structures become possible as the number of electrodes is increased, but only a few have practical applications. Of the possible four-element arrangements, the only one in general use is that known as the *screen-grid* type.

### Screen-Grid Tetrodes

● In the section on tube oscillators it was explained that oscillations could be sustained through transfer of energy from the plate to the grid through the electrostatic capacity existing between plate and grid, the circuit of Fig. 511-B being used as an illustration. This circuit without the feed-back condenser is exactly the one we would want to use if the tube is intended to amplify, but not oscillate, at radio frequencies; that is, the input and output circuits must be tuned to the same frequency. However, the grid-plate capacity of the triode returns so much energy to the grid circuit from the plate that it is impossible to prevent the tube from oscillating. Consequently a triode cannot be used as an amplifier at radio frequencies without the use of special circuits. These are not very satisfactory when a considerable frequency range is to be covered, as in a receiver.

If a second grid, made in the form of an electrostatic shield between the control grid and plate, is added to the tube the grid-plate capacity can be reduced to a value which will not permit oscillations to occur. The *screen grid*, as it is called, has a definite effect on the characteristics of the tube. It increases the amplification factor and plate resistance of the tube to values much higher than are attainable in triodes of practicable construction, although the mutual conductance is about the same as that of an equivalent triode. The screen grid is ordinarily operated at a positive potential about one-third or less that placed on the plate, and is by-passed back to the cathode so that it has essentially the same a.c. potential as the cathode. A typical screen-grid receiving amplifier is shown in Fig. 515.

Large screen-grid tubes of the power type are used as amplifiers in transmitting installations. The screen-grid tube can be used as both plate and grid detector, generally showing greater sensitivity than the triode types. It has very little application in audio-frequency amplifiers, however.

### Pentodes

● The addition of the screen grid in the tetrode causes an undesirable effect which limits the usefulness of the tube. Electrons striking the plate at high speeds dislodge other elec-

trons which "splash" from the plate, this phenomenon being known as *secondary emission*. In the triode, ordinarily operated with the grid negative with respect to cathode, these secondary electrons are repelled back into the plate and cause no disturbance. In the screen-grid tube, however, the positively charged screen grid attracts the secondary electrons, causing a reverse current to flow between screen and plate. The effect is particularly marked when the plate and screen potentials are nearly equal, which may be the case during part of the a.c. cycle when the tube is delivering high output voltage.

To overcome the effects of secondary emission a third grid, called the *suppressor grid*, is inserted between the screen and plate. This grid, being connected directly to the cathode, repels the relatively low-velocity secondary electrons back to the plate without obstructing to any appreciable extent the regular plate-current flow. Larger undistorted outputs therefore can be secured from the pentode than from the tetrode.

Pentode-type screen-grid tubes are used as radio-frequency voltage amplifiers, and in addition can be used as audio-frequency voltage amplifiers to give high voltage gain per stage, since the pentode resembles the tetrode in having a high amplification factor. Pentode tubes also are suitable as audio-frequency power amplifiers, having greater plate efficiency than triodes and requiring less grid swing for maximum output. The latter quality can be indicated in another way by saying that the *power sensitivity* — ratio of power output to grid swing causing it — is higher. In audio power pentodes the function of the screen-grid is chiefly that of accelerating the electron flow rather than shielding, so that the grid often is called the *accelerator grid*. In radio-frequency voltage amplifiers the suppressor grid, in eliminating the secondary emission, makes it possible to operate the tube with the plate voltage as low as the screen voltage, which cannot be done with tetrodes.

As audio-frequency power amplifiers pentodes have inherently greater distortion (principally odd-harmonic distortion) than triodes. The output rating usually is based on a total distortion of 10%.

### Multi-Purpose Types

● A great many types of tubes have been developed to do special work in receiving circuits. Among the simplest of these are full-wave rectifiers, combining two separate diodes of the power type in one bulb, and twin-triodes, consisting of two triodes in one bulb for Class-

B audio amplification. To add the functions of diode detection and automatic volume control — described in Chapter Six — to that of amplification, a number of types are made in which two small diode plates are placed near the cathode, but not in the amplifier-portion structure. These types are known as duplex-diode triodes, or duplex-diode pentodes, depending upon the type of amplifier section incorporated.

Another type is the pentagrid converter, a special tube working as both oscillator and first detector in superheterodyne receivers. There are five grids between cathode and plate in the pentagrid converter; the two inner grids serve as control grid and plate of a small oscillator triode, while the fourth grid is the detector control grid. The third and fifth grids are connected together to form a screen-grid which shields the detector control grid from all other tube elements. The pentagrid converter eliminates the need for special coupling between the oscillator and detector circuits.

Another type of tube consists of a triode and pentode in one bulb, for use in cases where the oscillator and first detector are preferably separately coupled; while still another type is a pentode with a separate grid for connection to an external oscillator circuit. This "injection" grid provides a means for introducing the oscillator voltage into the detector circuit by electronic means.

Receiving screen-grid tetrodes and screen-grid pentodes for radio-frequency voltage amplification are made in two types, known as "sharp cut-off" and "variable- $\mu$ " or "super-control" types. In the sharp cut-off type the amplification factor is practically constant regardless of grid bias, while in the variable- $\mu$  type the amplification factor decreases as the negative bias is increased. The purpose of this design is to permit the tube to handle large signal voltages without distortion in circuits in which grid-bias control is used to vary the amplification, and to reduce interference from stations on frequencies near that of the desired station by preventing cross-modulation. Cross-modulation is modulation of the desired signal by an undesired one, and is practically the same thing as detection. The variable- $\mu$  type of tube is a poor detector in circuits used for r.f. amplification, hence cross-modulation is reduced by its use.

## Receiving Tubes — Types of Cathodes

● In the practical construction of receiving tubes there are two types of envelopes or "enclosures", glass and metal. Glass bulbs have been the rule since the early days of tube

manufacture; recently, however, welded metal envelopes have been introduced. The metal envelope can be utilized to act as an electrostatic shield for the tube elements.

Receiving tubes can be divided into groups according to the type of cathode used. Cathodes have been the subject of much research and development, so it is but natural to find that several tube types more or less duplicate each other except for the type of cathode.

Cathodes are of two types, directly and indirectly heated. Directly-heated cathodes or filaments used in receiving tubes are of the oxide-coated type, consisting of a wire or ribbon of tungsten coated with certain rare metals and earths which form an oxide capable of emitting large numbers of electrons with comparatively little cathode-heating power. In modern receiving tube types, directly-heated cathodes are confined to audio power-output tubes, power rectifiers and the groups intended for operation from dry-cell batteries, where economy of filament current is highly important.

When directly-heated cathodes are operated on alternating current, the cyclic variation of current causes electrostatic and magnetic effects which vary the plate current of the tube at supply-frequency rate and thus produce hum in the output. Even though the hum can be reduced considerably by proper circuit design, it is still too high in level to be tolerated in multi-tube amplifiers, since the hum appearing at the first tube is amplified through the whole set. Hum from this source is eliminated by the indirectly-heated cathode, consisting of a thin metal sleeve or thimble, coated with electron-emitting material, enclosing a tungsten wire which acts as a heater. The heater brings the cathode thimble to the proper temperature to cause electron emission. This type of cathode is also known as the equipotential cathode, since all parts are at the same potential. The cathode ordinarily is not connected to the heater inside the tube, the terminals of the two parts being brought out to separate base pins.

The first receiving tube filaments were intended to be operated from a six-volt storage battery through a rheostat, hence we find them designed for a terminal voltage of five volts d.c. These and a few early dry-battery types have now been superseded. The first tubes for a.c. heating of the cathodes were designed for 2.5 volts; a very large number of tubes having this cathode voltage are available, some directly and some indirectly heated. When auto radio sets first became popular, a new series of tubes designed for operation at 6.3 volts was



made available. This voltage later was adopted for a.c.-operated tubes, and is now standard. All recent types except dry-battery types operate at this cathode voltage. The battery series operates with a terminal voltage of two volts.

In addition to grouping by cathode voltages, it is also necessary to make some distinction between older and newer types of 2.5-volt tubes according to the heater current consumed, and also to differentiate between glass and metal tubes. In each series will be found general-purpose triodes, sharp cut-off screen grid tubes, variable- $\mu$  screen grid tubes, power amplifiers of the triode or pentode type, and special purpose tubes. There are also rectifier tubes for the power supply. The logical groupings of tubes are given in the form of tables with the essential characteristics and operating conditions of each type.

### Ratings and Characteristics

● The tables give maximum ratings for the various types of tubes listed. In the interests of long tube life, filament or heater voltages should be maintained as nearly as possible at the rating given (variations not more than 5% either above or below rated voltage) and the maximum plate-supply voltage indicated should not be exceeded. It is important, of course, that the tube be operated with the proper negative bias, as indicated by the tables, applied to the grid. Methods of obtaining bias will be treated in the chapters on receiver and transmitter design.

The important characteristics of the tubes, such as amplification factor, mutual conductance, etc., also are given. In addition, the *interelectrode capacitances* are listed in the tables of transmitting tubes. Since transmitting tubes often are large in physical structure, these capacities can be quite high with some types of tubes, limiting their application in very high frequency transmitters, since the tube capacity acts as a shunt across the tuning condenser. The important tube capacities are those between grid and cathode (input capacity), grid and plate, and plate and cathode (output capacity). Input and output capacities of receiving tubes usually are quite small—a few micromicrofarads for most tubes.

### Base Connections and Pin Numbering

● The older tube bases will be found to have from four to seven pins for element connections. In all except the five-prong type, the two cathode pins are heavier than the others, making them readily distinguishable. The pins

are numbered according to the following system: Looking at the bottom of the base or the bottom of the socket, the left-hand cathode pin is No. 1, and the others are numbered consecutively in the clockwise direction, ending with the right-hand cathode pin.

When metal tubes were brought out, a universal-type 8-pin or "octal" base was introduced. Usually only those pins needed for

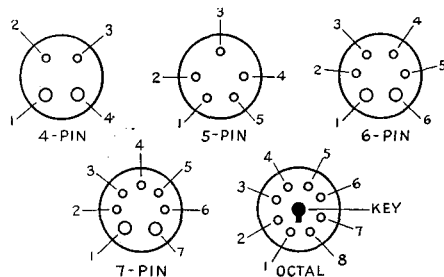

FIG. 516 — TUBE-BASE PIN NUMBERING SYSTEM

*These drawings show the pins looking at the bottom of a tube base or socket. Pins are numbered in the clockwise direction, starting with the left-hand cathode pin as No. 1 with glass tubes; with the shield pin as No. 1 with metal tubes. On the 4-, 6- and 7-pin bases the cathode pins are heavier than the others; on the 5-pin and octal bases the No. 1 pin is readily identified from the drawings above.*

connections are actually molded into the base, but the design is such that a single type of socket will handle any tube equipped with an octal base. The base and pin-numbering diagrams are shown in Fig. 516.

In indicating which element is connected to which base pin, it is customary to use the letters F, F, or H, H for filament or heater, C or K for cathode, P for plate, etc. In multi-grid tubes the grids are numbered according to the position they occupy, the grid nearest the cathode being No. 1, the next No. 2, etc. Some tubes are provided with a cap connection on top, especially when it is desired that the elements connected to the cap have very low capacity to other tube elements.

### Tube Numbering

● Until recently arbitrary numbers were assigned to tubes as they were placed on the market. For the past few years, however, a numbering system has been in effect which to some extent indicates the nature of the tube. These designations consist of a number, a letter, and a final number. The first number indicates the cathode voltage, the letter the individual tube of the series, the first being designated A, the second B, and so on, except for rectifiers, which start with Z and go back-

# The Radio Amateur's Handbook . . . . .

wards; the last number indicates the number of useful elements brought out to pin connections. Cathode voltages are indicated by 1 for 2-volt tubes, 2 for 2.5 volts, 5 for 5 volts, 6 for 6.3 volts, 12 for 12 volts, and 25 for 25 volts. In the final number, the filament or heater counts as one element, although always having two connections.

For example, the 2A6 is a 2.5-volt tube hav-

ing six elements brought out to connections (cathode, heater, triode grid, triode plate, and two diode plates) and is the first six-element tube of the 2.5-volt series, designated by the "A". The 5Z3 is a five-volt rectifier having three elements (cathode and two plates) brought out to connections, and is the first rectifier numbered according to this system. Other examples readily can be worked out.

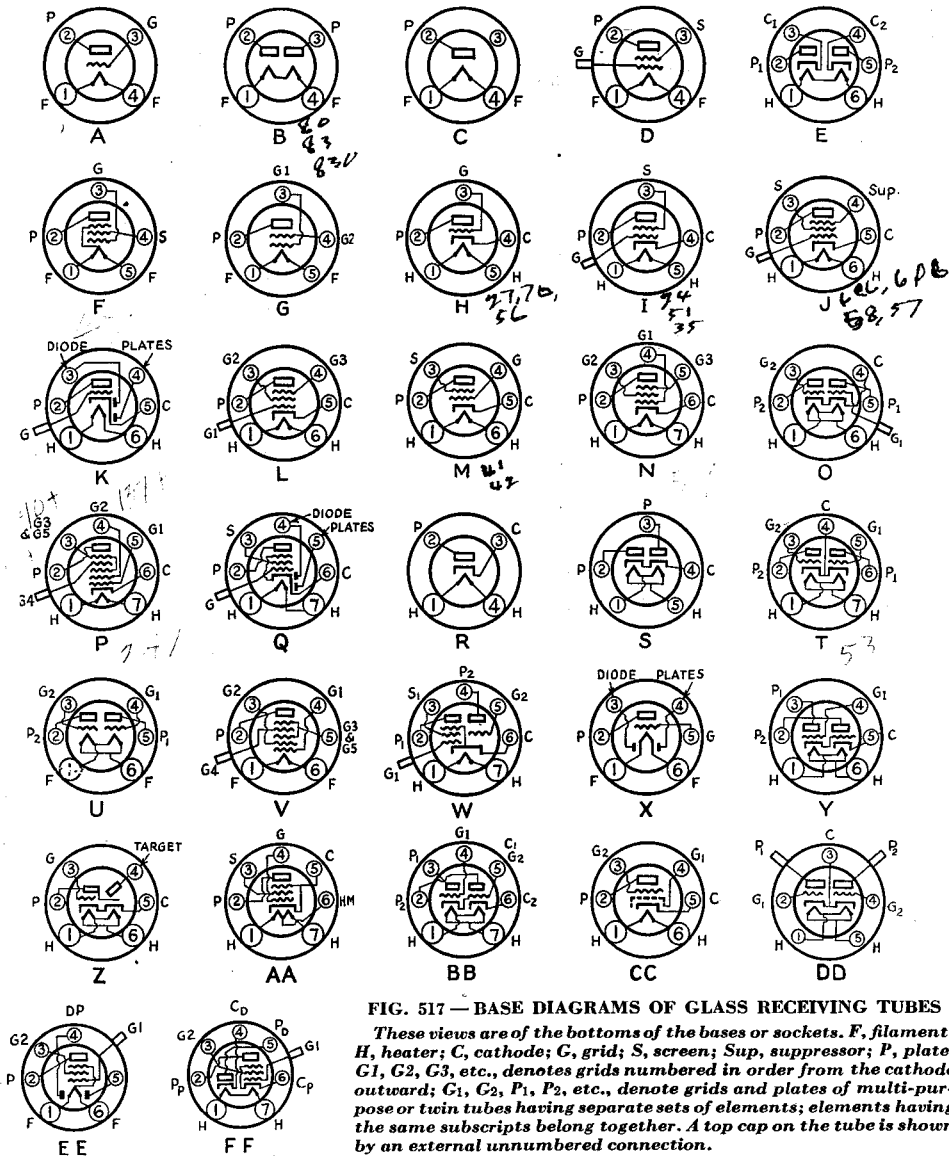

**FIG. 517 — BASE DIAGRAMS OF GLASS RECEIVING TUBES**  
 These views are of the bottoms of the bases or sockets. F, filament; H, heater; C, cathode; G, grid; S, screen; Sup, suppressor; P, plate. G1, G2, G3, etc., denotes grids numbered in order from the cathode outward; G1, G2, P1, P2, etc., denote grids and plates of multi-purpose or twin tubes having separate sets of elements; elements having the same subscripts belong together. A top cap on the tube is shown by an external unnumbered connection.

## Multi-Grid Tubes — Element Connections

● A number of receiving tubes are so constructed that one type can be made to serve several different purposes simply by re-arranging the element connections. Thus we find power amplifier tubes with two or three grids, which can be connected in various ways to make the tube suitable for use as a Class-A triode power amplifier, as a Class-B triode amplifier, or as a Class-A pentode amplifier. The Type 59, a triple-grid tube, is an example. If the inner grid, No. 1, is used as the control grid while Nos. 2 and 3 are connected to the plate, the tube is a triode suitable for Class-A power amplification. If, however, No. 1 grid is connected to the middle grid, No. 2, while No. 3, the outer grid, is connected to the plate, the tube can be used without bias as a Class-B amplifier. Still a third method of connection makes the 59 a Class-A pentode; Grid No. 1 is the control grid, No. 2 the screen or accelerator, while No. 3, connected to the cathode, becomes the suppressor. The connections to be used with the several types of tubes falling in this classification are indicated in the tables.

## “G” Tubes and Preferred Types

● The tremendous number of receiving tube types available is likely to appall the neophyte who wants to pick out the most suitable tube for the application he has in mind. However, despite the fact that additions are made to the lists very frequently, actually the trend is now towards simplification of the status of receiving-tube types. We do not hesitate to predict that eventually all tubes in current use for design purposes will have octal bases; it is an accomplished fact that such tubes are now universally equipped with 6.3-volt filaments in the a.c. series; other filament voltages have been discarded.

Practically all the now-used glass tubes can be obtained with octal bases. Such tubes have

the suffix “G” attached to the type number. In some cases these tubes duplicate in characteristics types in the metal series; when this is so, the tube carries the same number as the corresponding metal tube, but with the suffix “G”. For example, the glass equivalent of the 6K7 metal tube is known as the 6K7G. Other “G” tubes duplicate existing types of glass

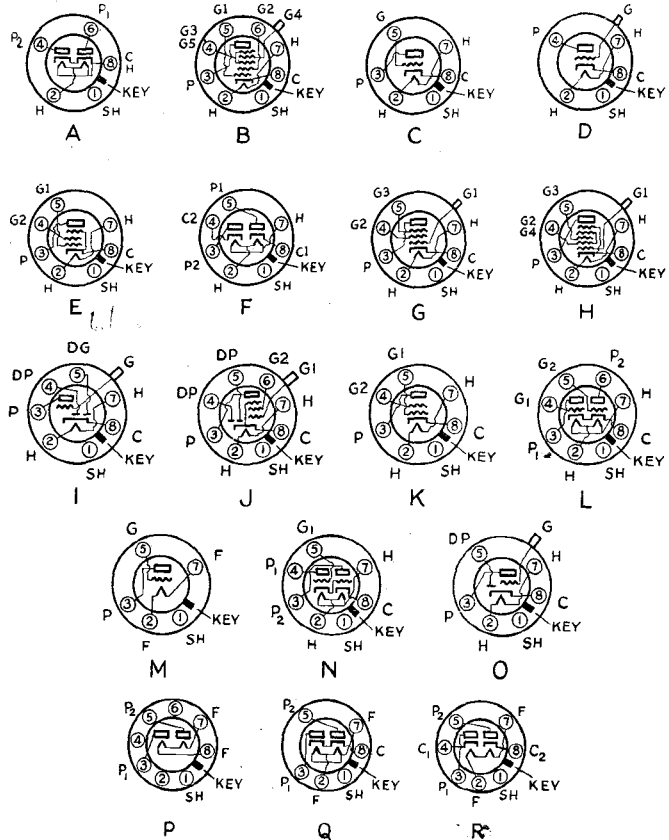

FIG. 518 — BASE DIAGRAMS OF METAL AND 6.3-VOLT “G” TYPE RECEIVING TUBES

*Legends have the same significance as in Fig. 517 with the addition of DP, diode plates, and SH, shield; the shield is the metal envelope of the tube, in all cases connected to pin No. 1. Views are of bottoms of tube bases or sockets.*

tubes, in which case a new number generally is required to conform to the present numbering system. In still other cases the tube is a new type equipped with an octal base. Tables I-A and IV-A list the “G” type tubes, giving the equivalents when such exist.

There are fourteen tube designs most popularly in use in present-day receivers. These fourteen occur more or less completely in six

# The Radio Amateur's Handbook . . . . .

series: metal, 6.3-volt glass with octal bases, 6.3-volt glass with old bases, 2.5-volt glass with old bases, 2.0-volt (battery) glass with octal bases, and 2.0-volt glass with old bases. The currently-used types under these classifica-

secured from the a.v.c. line. The triode grid also may be connected to the detector diode in the receiver. The greater the rectified voltage, the narrower the shadow on the screen, thus the tube can be used to indicate exact

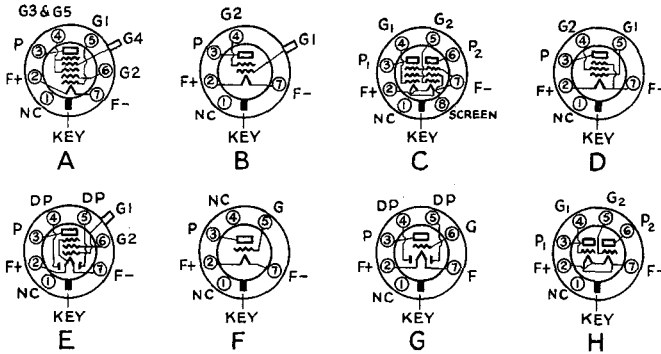

FIG. 518-A — SOCKET-CONNECTION DIAGRAMS FOR OCTAL-BASED 2.0-VOLT TUBES

These views are of the bottoms of tube sockets or bases. Nomenclature same as in Figs. 517 and 518; NC on No. 1 pin indicates no connection to this pin inside the tube; it is suggested that this socket con-

nection be grounded, however, to provide for possible metal-shell tubes in this series. (Note: In some cases the tube may be provided with more pins than are indicated in the above diagrams. This is a manufacturing convenience; the extra pins have no connections and can be ignored.)

tions have been arranged in a table of "preferred types", which gives the set designer and constructor a list of the tubes most worthy of consideration. For design purposes, it is possible to discard the types with old bases, so that there are only three fundamental classifications: metal, 6.3-volt glass, and 2.0-volt glass. Actually, therefore, only some fourteen tubes need be considered when planning a receiver, after the filament voltage has been chosen. Data on the older types are given in the tables; the information is necessary for replacement purposes or to identify types which may be in the possession of the builder.

### Beam Power Tubes and Electron-Ray Tubes

● As stated in the preceding section, there are approximately fourteen tube designs which cover practically all receiver requirements. In addition, a miniature cathode-ray tube, known as an electron-ray tube or, popularly, the "magic eye", is available for use as a tuning indicator. The electron-ray tube consists of a triode amplifier and fluorescent screen with a target in one bulb. An extension of the triode plate acts as a ray-control electrode which causes a shadow to appear on the screen; the width of the shadow is determined by the potential at the plate. The plate potential in turn is a function of the triode grid voltage. In practice, the triode section ordinarily is used as a d.c. amplifier, its grid voltage being

resonance in tuning. It also has applications in measurement work, as in a vacuum-tube voltmeter (see Chapter Seventeen). Three types of tubes are available, the difference being in the characteristics of the triode section.

A new principle of tube construction is incorporated in the "beam" power tube, the 6L6 and 6L6G. Although this tube has only four electrodes, it has pentode characteristics because the method of construction causes an electronic suppressor to be formed between accelerator grid and plate. In the table of preferred types it is therefore listed as a pentode. The tube has very high power sensitivity and works at high plate efficiency, and is capable of giving considerably more output than ordinary tubes at moderate plate voltages.

### Special Types of Tubes

● Tubes designed for special purposes or differing widely in characteristics from those listed in the other tables are shown in Table V. Included in these are power tubes intended for operation from 110-volt d.c. mains. The 43 and 48 are power amplifiers of the vacuum-tube type for this purpose, while the RK100 is a mercury-vapor tube of special design built to give large power outputs at this voltage. The 12A5, 12A7 and 25A6 are multi-purpose types particularly designed for use with "universal" or a.c.-d.c. receivers. The 954 and 955 are min-

ature tubes — “acorn” type — which function well at ultra-high frequencies where tubes of ordinary construction are inoperative; they can be used for amplification, detection and oscillation at wavelengths as short as  $\frac{3}{4}$  meter. The 864 is a non-microphonic triode amplifier for battery-operated amplifiers such as are used with condenser microphones. The 885, a gas-filled triode, is used as a relaxation oscillator in oscilloscope sweep circuits.

Many other types of tubes, including low-grid current tubes for measurements purposes and grid-controlled rectifiers, or thyratrons, are manufactured, but because of their limited application in amateur work or the difficulty of obtaining them, are not included in the tables.

## Rectifiers

● Rectifiers for receiving purposes are made with both directly and indirectly-heated cathodes, and are provided with one or two plates depending upon whether the tube is designed for half-wave or full-wave rectification. The tubes may be either of the high-vacuum or mercury-vapor type. The latter type has a small quantity of mercury added after the air is removed from the tube; when the cathode is heated the mercury vaporizes. When the tube is in operation electrons striking the mercury-vapor molecules dislodge other electrons, “ionizing” the gas, as explained in Chapter Three. This increases the conductivity and results in a lower voltage drop in the rectifier, giving better voltage regulation (see Chapter Fifteen) and higher efficiency. Mercury-vapor rectifiers are likely to cause noise in the receiver, however, so are seldom used for receiving purposes.

High-voltage rectifiers for transmitters are nearly all of the mercury-vapor type, since voltage regulation and efficiency are more important than in receiving applications. Rectifiers which are designed to handle voltages up to about 500 usually are made with two plates and are called full-wave rectifiers; tubes for

higher voltages, however, almost always have but one plate and are known as half-wave rectifiers. Their uses are explained in Chapter Fifteen.

## Transmitting Tubes

● Transmitting tubes are simply larger versions of the smaller receiving tubes, adapted for the handling of large amounts of power and for operation at high plate voltages. Receiving tubes of the audio power-amplifier type are in fact often used in low-power transmitters — and also in the low-power stages of high-power transmitters — hence some receiving types will be found to have transmitting ratings in the tables. Tubes intended particularly for the

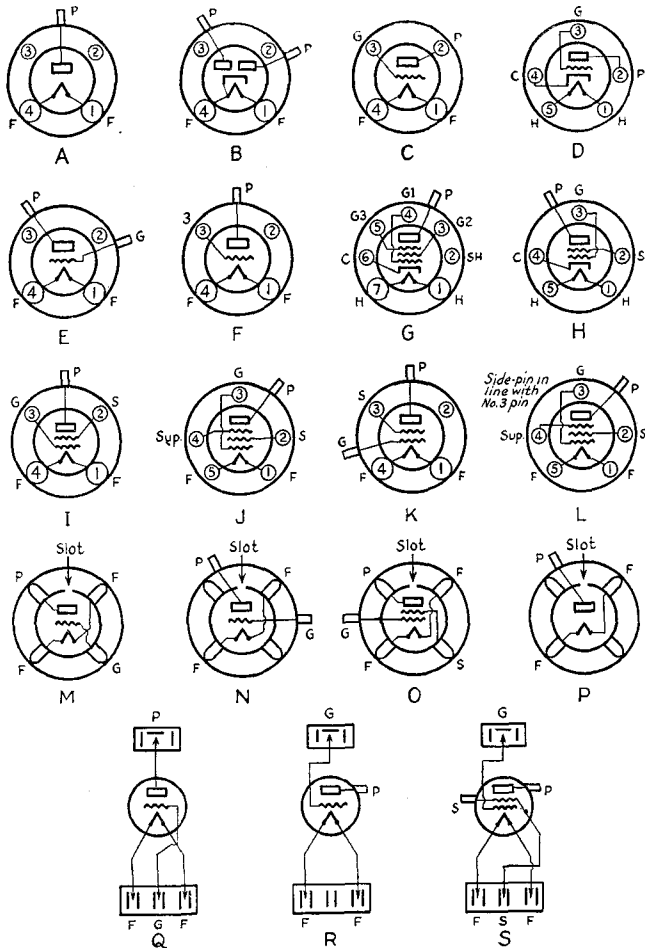

FIG. 519 — SOCKET CONNECTIONS FOR TRANSMITTING TUBES  
Views are of tops of sockets. Legends have the same significance as in Figs. 517 and 518.

# The Radio Amateur's Handbook . . . . .

PREFERRED RECEIVING TUBE TYPES BY FUNCTIONS						
Descriptions	Metal Octal	Glass 6.3 V. Octal	Glass 6.3 V. Old	Glass 2.5 V. Old	Glass 2.0 V. Octal	Glass 2.0 V. Old
General Purpose Triode . . . . .	6C5	6C5G 6J5G	76	56	1H4G	30
High- $\mu$ Triode . . . . .	6F5	6F5G 6K5G	....	....	....	....
R.F. Amplifier, sharp cutoff . . . . .	6J7	6J7G	6C6	57	1E5G	1B4
R.F. Amplifier variable- $\mu$ . . . . .	6K7	6K7G	6D6	58	1D5G	1A4
Twin Diode . . . . .	6H6	6H6G	....	....	....	....
Duplex-Diode Pentode . . . . .	6B8	6B8G	6B7	2B7	1F7G	1F6
Duplex-Diode G.P. Triode . . . . .	6R7	6R7G	85	55	1H6G	1B5
Duplex-Diode High- $\mu$ Triode . . . . .	6Q7	6Q7G 6B6G	75	2A6	....	....
Pentagrid Converter . . . . .	6A8	6A8G 6D8G	6A7	2A7	1D7G 1C7G	1A6 1C6
Pentagrid Mixer-Amp. . . . .	6L7	6L7G	....	....	....	....
Pentode Power Amp. . . . .	6F6 6L6	6F6G 6L6G	42 (41)	2A5	1F5G 1E7G	1F4 33
Triode Power Amp. . . . .	....	6B4G	6A3	45 2A3	....	31
Twin Triode Power Amp. . . . .	6N7	6N7G	6A6	53	1J6G	19
Direct-Coupled Power Amp. . . . .	6N6MG	6N6G	6B5	....	....	....

generation of radio-frequency power are of more rugged construction, and when built for operation at voltages of 750 or more are universally provided with thoriated tungsten filaments.

Transmitting tubes are generally rated by plate dissipation, which is the amount of power that can be radiated safely as heat by the plate. The power output obtainable depends upon the efficiency of the circuit used. Maximum plate voltage and maximum plate current ratings also are given for the various types. The uses of the various columns in the transmitting tube tables is explained in the chapters dealing with transmitters and radiotelephony.

Only three types of transmitting tubes are in general use — triodes, screen-grid tetrodes, and screen-grid pentodes. Triodes are used as oscillators and as power amplifiers in special circuits, and certain types also are suitable for delivering considerable audio power for modu-

lation purposes. Screen-grid tetrodes and screen-grid pentodes are used chiefly as power amplifiers, although also having special oscillator applications.

The characteristics and typical r.f. operating conditions of transmitting tubes suitable for amateur use are given in Tables VIII and IX. The selection of types for various purposes is discussed in detail in later chapters on transmitter design and construction. In the tables, the tubes have been listed according to plate dissipation ratings. Generally speaking, the higher the plate dissipation rating the greater the power output the tube can deliver. It should be understood, however, that the power output obtainable depends considerably on the way in which the tube is operated; also that at the higher frequencies certain types of tubes are capable of better operation than others. Tubes especially designed for high-frequency use (3000 kc. and higher) are indicated.

TABLE 1—6.3-VOLT GLASS RECEIVING TUBES

Type	Name	Base <sup>4</sup>	Socket Connections <sup>1</sup>	Cathode	Fil. or Heater		Use	Plate Supply Volts	Grid Bias	Screen Volts	Screen Current Ma.	Plate Current Ma.	Plate Resistance, Ohms	Mutual Conductance Micromhos	Amp. Factor	Load Resistance Ohms	Power Output Watts	Type	
					Volts	Amps													
6A3	Triode Power Amplifier	4-pin M.	A	Fil.	6.3	1.0	Class-A Amplifier	250	-4.5	—	—	6.0	800	5250	4.2	2500	3.2	6A3	
							Push-Pull Amplifier	325 395	-6.8	Fixed Bias Self Bias		4.0 4.0	Power Output for 2 tubes Load Plate-to-Plate			3000 5000	1.5 1.0		
6A4 <sup>4</sup>	Pentode Power Amplifier	5-pin M.	F	Fil.	6.3	0.3	Class-A Amplifier	100 180	-6.5 -12.0	100 180	1.6 3.9	9.0 22.0	83250 45500	1200 2200	100 100	11000 8000	0.31 1.40	6A4	
6A6	Twin Triode Amplifier	7-pin M.	T	Htr.	6.3	0.8	Class-B Amplifier	250 300	0 0	—	—	Power output is for one tube at stated load, plate-to-plate				8000 10000	8.0 10.0	6A6	
6A7	Pentagrid Converter	7-pin S.	P	Htr.	6.3	0.3	Converter	250	-3.0 min.	100	2.2	3.5	360000	Anode grid (No. 2) 200 volts max., 4.0 ma. Grid leak, 50000 ohms.				—	6A7
6B5	Direct-Coupled Power Amplifier	6-pin M.	Y	Htr.	6.3	0.8	Class-A Amplifier	300	0	—	6.5	45	241000	2400	58	7000	4.0	6B5	
							Push-Pull Amplifier	400	-13	4.5 <sup>5</sup>	40	—	—	—	10000	20			
6B7	Duplex-Diode Pentode	7-pin S.	Q	Htr.	6.3	0.3	Pentode R.F. Amplifier	250	-3.0	125	2.3	9.0	650000	1125	730	—	—	6B7	
							Pentode A.-F. Amplifier	250	-4.5	50	—	0.65	—	—	—	—			
6C6	Triple-Grid Detector Amplifier	6-pin S.	J	Htr.	6.3	0.3	Screen-Grid R.F. Amplifier	250	-3.0	100	0.5	2.0	—	1225	exceeds 1500	—	—	6C6	
							Bias Detector	250	-1.95	50	Cathode current 0.65 ma.		—	Plate coupling resistor 250000 ohms					
6D6	Triple-Grid Variable- $\mu$ Amplifier	6-pin S.	J	Htr.	6.3	0.3	Screen-Grid R.F. Amplifier	250	-3.0	100	2.0	8.2	800000	1600	1280	—	—	6D6	
							Mixer	250	-10.0	100	—	—	Oscillator peak volts = 7.0						
6E5	Electron Ray Tube	6-pin S.	Z	Htr.	6.3	0.3	Indicator Tube	250	0	Cut-off Grid Bias = -8.0 v.		0.25	Target Current 4.5 ma.				—	6E5	
6E6	Twin Triode Amplifier	7-pin M.	T	Htr.	6.3	0.6	Class-A Push-Pull Amplifier	180 250	-20 -27.5	Per plate—11.5 Per plate—18.0		—	4300 3500	1400 1700	6.0 6.0	15000 14000	0.75 1.6	6E6	
							Triode Unit Amplifier	100	-3.0	—	—	3.5	17800	450	8	—			
6F7	Triode Pentode	7-pin S.	W	Htr.	6.3	0.3	Pentode Unit Amplifier	250	-3.0	100	1.5	6.5	850000	1100	900	—	—	6F7	
							Pentode Unit Mixer	250	-10.0	100	0.6	2.8	Oscillator peak volts = 7.0						
6G5	Electron-Ray Tube	6-pin S.	Z	Htr.	6.3	0.3	Indicator Tube	250	0	Cut-off Grid Bias = 22 v.		0.24	Target Current 4.5 ma.				—	6G5	
6N5	Electron-Ray Tube	6-pin S.	Z	Htr.	6.3	0.15	Indicator Tube	135	0	Cut-off Grid Bias = -12 v.		0.5	Target Current 4.5 ma.				—	6N5	
36	Tetrode R.F. Amplifier	5-pin S.	I	Htr.	6.3	0.3	Screen-Grid R.F. Amplifier	100 180 250	-1.5 -3.0 -3.0	55 90 90	— — 1.7	1.8 3.1 3.2	550000 500000 550000	850 1050 1080	470 525 595	—	—	36	
							Bias Director	100 250	-5.0 -8.0	55 90	—	—	Plate Current to be adjusted to 0.1 ma. with no signal						
37	Triode Detector Amplifier	5-pin S.	H	Htr.	6.3	0.3	Class-A Amplifier	90 180 250	-6.0 -13.5 -18.0	—	—	2.5 4.3 7.5	11500 10200 8400	800 900 1100	9.2 9.2 9.2	—	—	37	
							Bias Detector	90 250	-10.0 -28.0	—	—	Plate Current to be adjusted to 0.2 ma. with no signal							

Vacuum Tubes

TABLE I—6.3-VOLT GLASS RECEIVING TUBES—Continued

Type	Name	Base <sup>1</sup>	Socket Connections <sup>1</sup>	Cathode	Fil. or Heater		Use	Plate Supply Volts	Grid Bias	Screen Volts	Screen Current Ma.	Plate Current Ma.	Plate Resistance, Ohms	Mutual Conductance Micromhos	Amp. Factor	Load Resistance Ohms	Power Output Watts	Type	
					Volts	Amps													
38	Pentode Power Amplifier	5-pin S.	I <sup>2</sup>	Htr.	6.3	0.3	Class-A Amplifier	100	-9.0	100	1.2	7.0	140000	875	120	15000	0.27	38	
								180	-18.0	180	2.4	14.0	115000	1050	120	11600	1.00		
								250	-25.0	250	3.8	22.0	100000	1200	120	10000	2.50		
39 44	Variable- $\mu$ R.F. Amplifier Pentode	5-pin S.	I <sup>2</sup>	Htr.	6.3	0.3	Screen-Grid R.F. Amplifier	90	-3.0	90	1.6	5.6	375000	960	360	—	—	39 44	
								180	min.	90	1.4	5.8	750000	1000	750	—	—		
								250		90	1.4	5.8	1000000	1050	1050	—	—		
41	Pentode Power Amplifier	6-pin S.	M <sup>2</sup>	Htr.	6.3	0.4	Class-A Amplifier	100	-7.0	100	1.6	9.0	103500	1450	150	12000	0.33	41	
								180	-13.5	180	3.0	18.5	81000	1850	150	9000	1.50		
								250	-18.0	250	5.5	32.0	68000	2200	150	7600	3.40		
42	Pentode Power Amplifier	6-pin M.	M <sup>2</sup>	Htr.	6.3	0.7	Class-A Amplifier	250	-16.5	250	6.5	34.0	100000	2200	220	7000	3.0	42	
75	Duplex-Diode High- $\mu$ Triode	6-pin S.	K	Htr.	6.3	0.3	Triode Amplifier	250	-1.35	—	—	0.4	91000	1100	100	—	—	75	
76	Triode Detector Amplifier	5-pin S.	H	Htr.	6.3	0.3	Class-A Amplifier	250	-13.5	—	—	5.0	9500	1450	13.8	—	—	76	
								250	-20.0	Plate current to be adjusted to 0.2 ma. with no signal									
77	Triple-Grid Detector Amplifier	6-pin S.	J	Htr.	6.3	0.3	Screen-Grid R.F. Amplifier	100	-1.5	60	0.4	1.7	650000	1100	715	—	—	77	
								250	-3.0	100	0.5	2.3	1500000	1250	1500	—	—		
78	Triple-Grid Variable- $\mu$ Amplifier	6-pin S.	J	Htr.	6.3	0.3	Screen-Grid R.F. Amplifier	90	-3.0	90	1.3	6.4	315000	1275	400	—	—	78	
								180	min.	75	1.0	4.0	1000000	1100	1100	—	—		
79	Twin Triode Amplifier	6-pin S.	O	Htr.	6.3	0.6	Class-B Amplifier	180	0	—	—	—	Power output is for one tube at stated load, plate-to-plate				7000	5.5	79
								250	0	—	—	—	—	14000	8.0				
85	Duplex Diode Triode	6-pin S.	K	Htr.	6.3	0.3	Triode Unit as Class-A Amplifier	135	-10.5	—	—	3.7	11000	750	8.3	25000	0.075	85	
								180	-13.5	—	—	6.0	8500	975	8.3	20000	0.160		
								250	-20.0	—	—	8.0	7500	1100	8.3	20000	0.350		
89	Triple-Grid Power Amplifier	6-pin S.	L	Htr.	6.3	0.4	Class-A Triode Amplifier <sup>6</sup>	160	-20.0	—	—	17.0	3300	1425	4.7	7000	0.300	89	
								180	-22.5	—	—	20.0	3000	1550	4.7	6500	0.400		
								250	-31.0	—	—	32.0	2600	1800	4.7	5500	0.900		
							Class-A Pentode Amplifier <sup>7</sup>	100	-10.0	100	1.6	9.5	104000	1200	125	10700	0.33		
								180	-18.0	180	3.0	20.0	80000	1550	125	8000	1.50		
								250	-25.0	250	5.5	32.0	70000	1800	125	6750	3.40		
Class-B Triode Amplifier <sup>8</sup>	180	0	—	—	Power output is for 2 tubes at stated load, plate-to-plate										13600	2.50			

<sup>1</sup> Refer to Fig. 517  
<sup>2</sup> Suppressor grid, connected to cathode inside tube, not shown on base diagram.  
<sup>3</sup> Also known as Type LA.  
<sup>4</sup> S—small; M—medium.  
<sup>5</sup> Current to input plate (P<sub>1</sub>).  
<sup>6</sup> Grids Nos. 2 and 3 connected to plate.  
<sup>7</sup> Grid No. 2, screen; grid No. 3, suppressor.  
<sup>8</sup> Grids Nos. 1 and 2 tied together; grid No. 3 connected to plate



TABLE IA — 6.3-VOLT GLASS TUBES WITH OCTAL BASES

Type	Name	Socket Connections <sup>1</sup>	Cathode	Fil. or Heater		Use	Plate Supply Volts	Grid Bias	Screen Volts	Screen Current Ma.	Plate Current Ma.	Plate Resistance, Ohms	Mutual Conductance Micromhos	Amp. Factor	Load Resistance Ohms	Power Output Watts	Type
				Volts	Amps.												
6A8G	Pentagrid Converter	B	Htr.	6.3	0.3	Converter	Characteristics same as Type 6A8 — Table III						—	—	—	6A8G	
6B4G	Triode Power Amplifier	M	Fil.	6.3	1.0	Power Amplifier	Characteristics same as Type 6A3 — Table I						—	—	—	6B4G	
6B6G	Duplex-Diode High- $\mu$ Triode	I	Htr.	6.3	0.3	Detector-Amplifier	Characteristics same as Type 75 — Table I						—	—	—	6B6G	
6B8G	Duplex-Diode Pentode	J	Htr.	6.3	0.3	Detector-Amplifier	Characteristics same as Type 6B8 — Table III						—	—	—	6B8G	
6C5G	Triode Detector Amplifier	C	Htr.	6.3	0.3	Detector-Amplifier	Characteristics same as Type 6C5 — Table III						—	—	—	6C5G	
6D8G	Pentagrid Converter	B	Htr.	6.3	0.15	Converter	135 250	-3.0 -3.0 min.	67.5 100	Cathode current 8.0 Ma. Cathode current 13.0 Ma.	Anode grid (No. 2) Volts=135 Anode grid (No. 2) Volts=250 through 20,000-ohm dropping resistor		—	—	—	6D8G	
6F5G	High- $\mu$ Triode	D	Htr.	6.3	0.3	Amplifier	Characteristics same as Type 6F5 — Table III						—	—	—	6F5G	
6F6G	Pentode Power Amplifier	E	Htr.	6.3	0.7	Power Amplifier	Characteristics same as Type 6F6 — Table III						—	—	—	6F6G	
6H6G	Twin Diode	F	Htr.	6.3	0.3	Rectifier	Characteristics same as Type 6H6 — Table III						—	—	—	6H6G	
6J5G	Triode Amplifier	C	Htr.	6.3	0.3	Class-A Amplifier	250	-8.0	—	—	9.0	7700	2600	20	—	—	6J5G
6J7G	R.F. Amplifier	G	Htr.	6.3	0.3	Detector-Amplifier	Characteristics same as Type 6J7 — Table III						—	—	—	6J7G	
6K5G	High- $\mu$ Triode	D	Htr.	6.3	0.3	Class-A Amplifier	100 250	-1.5 -3.0	—	—	0.35 1.1	78,000 50,000	900 1400	70 70	—	—	6K5G
6K7G	R.F. Amplifier	G	Htr.	6.3	0.3	Amplifier-Mixer	Characteristics same as Type 6K7 — Table III						—	—	—	6K7G	
6L5G	Triode Amplifier	C	Htr.	6.3	0.15	Class-A Amplifier	135 250	-5.0 -9.0	—	—	3.5 8.0	—	1500 1900	17 17	—	—	6L5G
6L6G	Beam Power Amplifier	K	Htr.	6.3	0.9	Power Amplifier	Characteristics same as Type 6L6 — Table III						—	—	—	6L6G	
6L7G	Pentagrid Mixer-Amplifier	H	Htr.	6.3	0.3	Amplifier-Mixer	Characteristics same as Type 6L7 — Table III						—	—	—	6L7G	
6N6G	Direct-Coupled Amplifier	N	Htr.	6.3	0.8	Power Amplifier	Characteristics same as Type 6B5 — Table I						—	—	—	6N6G	
6N7G	Twin Triode Amplifier	L	Htr.	6.3	0.8	Class-B Amplifier	Characteristics same as Type 6N7 — Table III						—	—	—	6N7G	
6Q6G	Diode-High- $\mu$ Triode	O	Htr.	6.3	0.15	Triode Section Class-A Amplifier	135 250	-1.5 -3.0	—	—	0.9 1.2	—	1000 1050	65 65	—	—	6Q6G
6Q7G	Duplex-Diode High- $\mu$ Triode	I	Htr.	6.3	0.3	Detector-Amplifier	Characteristics same as Type 6Q7 — Table III						—	—	—	6Q7G	
6R7G	Duplex-Diode Triode	I	Htr.	6.3	0.3	Detector-Amplifier	Characteristics same as Type 6R7 — Table III						—	—	—	6R7G	
6S7G	Triple-Grid Variable- $\mu$ Amplifier	G	Htr.	6.3	0.15	R.F. Amplifier	135 250	-3.0 -3.0 min.	67.5 100.0	0.9 2.0	3.7 8.5	—	1250 1750	850 1100	—	—	6S7G

<sup>1</sup> Refer to Fig. 518. No connection to Pin No. 1.

Vacuum Tubes

TABLE II—2.5-VOLT RECEIVING TUBES

Type	Name	Base <sup>3</sup>	Socket Connections <sup>1</sup>	Cathode	Fil. or Heater		Use	Plate Supply Volts	Grid Bias	Screen Volts	Screen Current Ma.	Plate Current Ma.	Plate Resistance, Ohms	Mutual Conductance Micromhos	Amp. Factor	Load Resistance Ohms	Power Output Watts	Type	
					Volts	Amps													
2A3	Triode Power Amplifier	4-pin M.	A	Fil.	2.5	2.5	Class-A Amplifier	250	-45	—	—	60.0	800	5250	4.2	2500	3.5	2A3	
							Push Pull Amplifier	300 300	-62 -62	—	—	40.0 40.0	Power Output for 2 tubes Load Plate-to-Plate		5000 3000	10.0 15.0			
2A5	Pentode Power Amplifier	6-pin M.	M <sup>2</sup>	Htr.	2.5	1.75	Class-A Amplifier	250	-16.5	250	6.5	34.0	100000	2200	220	7000	3.0	2A5	
2A6	Duplex-Diode High- $\mu$ Triode	6-pin S.	K	Htr.	2.5	0.8	Triode as Class-A Amp.	250	-1.35	—	—	0.4	—	—	Gain per stage = 50-60		—	2A6	
2A7	Pentagrid Converter	7-pin S.	P	Htr.	2.5	0.8	Converter	250	-3.0 min.	100	2.2	3.5	360000	Anode grid (No. 2) 200 max. volts, 4.0 ma. Grid leak, 50000 ohms			—	2A7	
2B6	Special Power Amplifier	7-pin M.	BB	Htr.	2.5	2.25	Amplifier	250	-24.0	—	—	40.0	5150	3500	18.0	5000	4.0	2B6	
2B7	Duplex-Diode Pentode	7-pin S.	Q	Htr.	2.5	0.8	Pentode R.F. Amplifier	100 250	-3.0 -3.0	100 125	1.7 2.3	5.8 9.0	300000 650000	950 1125	285 730	—	—	—	2B7
							Pentode A.F. Amplifier	250	-4.5	50	—	0.65	—	—	—	—	—	—	
24-A	Tetrode R.F. Amplifier	5-pin M.	I	Htr.	2.5	1.75	Screen-Grid R.F. Amplifier	180 250	-3.0 -3.0	90 90	1.7 1.7	4.0 4.0	400000 600000	1000 1050	400 630	—	—	24-A	
							Bias Detector	250	-5.0	20	Plate current adjusted to 0.1 ma. with no signal						—		—
27	Triode Detector-Amplifier	5-pin M.	H	Htr.	2.5	1.75	Class-A Amplifier	135 250	-9.0 -21.0	—	—	4.5 5.2	9000 9250	1000 975	9.0 9.0	—	—	27	
							Bias Detector	250	-30.0	—	Plate current adjusted to 0.2 ma. with no signal						—		—
35	Variable- $\mu$ Tetrode R.F. Amplifier	5-pin M.	I	Htr.	2.5	1.75	Screen-Grid R.F. Amplifier	180 250	-3.0 min.	90 90	2.5 2.5	6.3 6.5	300000 400000	1020 1050	305 420	—	—	35	
							Class-A Amplifier <sup>4</sup>	250	-33.0	—	—	22.0	2380	2350	5.6	6400	1.25		
45	Triode Power Amplifier	4-pin M.	A	Fil.	2.5	1.5	Class-A Amplifier	180 250 275	-31.5 -50.0 -56.0	180 250 275	—	31.0 34.0 36.0	1650 1610 1700	2125 2175 2050	3.5 3.5 3.5	2700 3900 4600	0.82 1.60 2.00	45	
46	Dual-Grid Power Amplifier	5-pin M.	G	Fil.	2.5	1.75	Class-A Amplifier <sup>4</sup>	250	-33.0	—	—	22.0	2380	2350	5.6	6400	1.25	46	
							Class-B Amplifier <sup>5</sup>	300 400	0 0	—	—	Power output for 2 tubes at stated load, plate-to-plate			5200 5800	16.0 20.0			
47	Pentode Power Amplifier	5-pin M.	F	Fil.	2.5	1.75	Class-A Amplifier	250	-16.5	250	6.0	31.0	60000	2500	150	7000	2.7	47	
53	Twin Triode Amplifier	7-pin M.	T	Htr.	2.5	2.0	Class-B Amplifier	250 300	0 0	—	—	Power output for 1 tube at stated load, plate-to-plate			8000 10000	8.0 10.0	53		
55	Duplex-Diode Triode	6-pin S.	K	Htr.	2.5	1.0	Triode Unit as Class-A Amplifier	135 180 250	-10.5 -13.5 -20.0	—	—	3.7 6.0 8.0	11000 8500 7500	750 975 1100	8.3 8.3 8.3	25000 20000 20000	0.075 0.160 0.350	55	
							Class-A Amplifier	250	-13.5	—	—	5.0	9500	1450	13.8	—	—		
56	Triode Amplifier, Detector	5-pin S.	H	Htr.	2.5	1.0	Class-A Amplifier	250	-13.5	—	—	5.0	9500	1450	13.8	—	—	56	
Bias Detector	250	-20.0	—	Plate current adjusted to 0.2 ma. with no signal						—	—								
57	Triple-Grid Detector Amplifier	6-pin S.	J	Htr.	2.5	1.0	Screen-Grid R.F. Amplifier	250	-3.0	100	0.5	2.0	exceeds 1.5 meg.	1225	exceeds 1500	—	—	57	
							Bias Detector	250	-1.95	50	Cathode current = 0.65 ma.			Plate resistor = 250000 ohms					
58	Triple-Grid Variable- $\mu$ Amplifier	6-pin S.	J	Htr.	2.5	1.0	Screen-Grid R.F. Amp.	250	-3.0	100	2.0	8.2	800000	1600	1280	—	—	58	
							Mixer	250	-10.0	100	—	—	Oscillator peak volts = 7.0			—	—		

TABLE II—2.5-VOLT RECEIVING TUBES

59	Triple-Grid Power Amplifier	7-pin M.	N	Htr.	2.5	2.0	Class-A Triode <sup>6</sup>		—	—	26.0	2300	2600	6.0	5000	1.25	59		
							250	-28.0				40000	2500	100	6000	3.0			
							Class-A Pentode <sup>7</sup>		250	-18.0	250	9.0	35.0	Power output for 2 tubes at stated load, plate-to-plate				4600	15.0
							Class-B Triode <sup>8</sup>		300	0	—	—				6000		20.0	

<sup>1</sup> Refer to Fig. 517.

<sup>2</sup> Suppressor grid, connected to cathode inside tube, not shown on base diagram.

<sup>3</sup> S.—small; M.—medium.

<sup>4</sup> Grid No. 2 tied to plate.

<sup>5</sup> Grids Nos. 1 and 2 tied together.

<sup>6</sup> Grids Nos. 2 and 3 connected to plate.

<sup>7</sup> Grid No. 2, screen; grid No. 3, suppressor.

<sup>8</sup> Grids Nos. 1 and 2 tied together; grid No. 3 connected to plate.

TABLE III—METAL RECEIVING TUBES

Type	Name	Base <sup>2</sup>	Socket Connections <sup>1</sup>	Cathode	Fil. or Heater		Use	Plate Supply Volts	Grid Bias	Screen Volts	Screen Current Ma.	Plate Current Ma.	Plate Resistance, Ohms	Mutual Conductance Micromhos	Amp. Factor	Load Resistance Ohms	Power Output Watts	Type
					Volts	Amps												
6A8	Pentagrid Converter	8-pin O.	B	Htr.	6.3	0.3	Converter	250	-3.0 min.	100	3.2	3.3	Anode-grid (No. 2) 250 volts max. thru 20,000-ohm dropping resistor, 4.0 ma.				6A8	
6B8	Duplex-Diode Pentode	8-pin O.	J	Htr.	6.3	0.3	Pentode R.F. Amplifier	250	-3.0	125	2.3	9.0	650000	1125	730	—	—	6B8
							Pentode A.F. Amplifier	250	-4.5	50	—	0.65	—	—	—	—	—	
6C5	Triode Detector Amplifier	6-pin O.	C	Htr.	6.3	0.3	Class-A Amplifier	250	-8.0	—	—	8.0	10000	2000	20	—	—	6C5
							Bias Detector	250	-17.0	—	—	Plate current adjusted to 0.2 ma. with no signal						
6F5	High- $\mu$ Triode	5-pin O.	D	Htr.	6.3	0.3	Class-A Amplifier	250	-1.3	—	—	0.2 to 0.4	66000	1500	100	0.25 to 1.0 meg.	—	6F5
6F6	Pentode Power Amplifier	7-pin O.	E	Htr.	6.3	0.7	Class-A Pentode	250 315	-16.5 -22.0	250 315	6.5 8.0	34 42	80000 75000	2500 2650	200 200	7000 7000	3.0 5.0	6F6
							Class-A Triode <sup>3</sup>	250	-20	—	—	31	2600	2700	7.0	4000	0.85	
							Push-Pull Class-AB Amp. Pentode Connection <sup>3</sup>	375 350	-26 -38	250 —	2.5 <sup>4</sup> —	17 <sup>4</sup> 22.5 <sup>4</sup>	Power output for 2 tubes at stated load, plate-to-plate		10000 6000	19 18		
6H6	Twin Diode	7-pin O.	F	Htr.	6.3	0.3	Rectifier	Max. a.c. voltage per plate = 100 r.m.s. Max. output current 2.0 ma. d.c.									6H6	
6J7	Triple-Grid Detector Amplifier	7-pin O.	G	Htr.	6.3	0.3	Screen-Grid R.F. Amplifier	250	-3.0	100	0.5	2.0	exceeds 15 meg.	1225	exceeds 1500	—	—	6J7
							Bias Detector	250	-4.3	100	Cathode current 0.43 ma.		—	—	0.5 meg.	—		
6K7	Triple-Grid Variable- $\mu$ Amplifier	7-pin O.	G	Htr.	6.3	0.3	Screen-Grid R.F. Amplifier	250	-3.0	125	2.6	10.5	600000	1650	990	—	—	6K7
							Mixer	250	-10	100	—	—	—	Oscillator peak volts = 7.0				

TABLE III—METAL RECEIVING TUBES—Continued

Type	Name	Base <sup>2</sup>	Socket Connections <sup>1</sup>	Cathode	Fil. or Heater		Use	Plate Supply Volts	Grid Bias	Screen Volts	Screen Current Ma.	Plate Current Ma.	Plate Resistance, Ohms	Mutual Conductance Micromhos	Amp. Factor	Load Resistance Ohms	Power Output Watts	Type				
					Volts	Amps																
6L6	Beam Power Amplifier	7-pin O.	K	Htr.	6.3	0.9	Single-Tube Class-A <sup>1 5</sup> Amp. Fixed Bias	250 375 375	-14.0 -9.0 -17.5	250 125 250	5.0 <sup>4</sup> 0.7 <sup>4</sup> 2.5 <sup>4</sup>	78 <sup>4</sup> 24 <sup>4</sup> 57 <sup>4</sup>	22500	6000	135	2500 14000 4000	6.5 4.2 11.5	6L6				
							Single-Tube Class-A <sup>1 5</sup> Amp. Self Bias	250 300 375	-13.5 -11.8 -9.0	250 300 125	5.4 <sup>4</sup> 3.0 <sup>4</sup> 0.7 <sup>4</sup>	75 <sup>4</sup> 51 <sup>4</sup> 24 <sup>4</sup>										
							Push-Pull A <sup>1 5</sup> Fixed Bias Self Bias	250 250	-16 -16	250 250	10 <sup>6</sup> 10 <sup>6</sup>	120 <sup>6</sup> 120 <sup>6</sup>							Power Output for 2 tubes. Load plate-to-plate	5000 5000		
							Push-Pull AB <sup>1 5</sup> Fixed Bias	400 400	-25 -20	300 250	6 <sup>6</sup> 4 <sup>6</sup>	102 <sup>6</sup> 88 <sup>6</sup>									6600 8500	34 26.5
							Push-Pull AB <sup>1 5</sup> Self Bias	400 400	-23.5 -19.0	300 250	7.0 <sup>6</sup> 4.6 <sup>6</sup>	112 <sup>6</sup> 96 <sup>6</sup>										
							Push-Pull AB <sup>2 5</sup> Fixed Bias	400 400	-25 -20	300 250	6 <sup>6</sup> 4 <sup>6</sup>	102 <sup>6</sup> 88 <sup>6</sup>									3800 6000	60 40
6L7	Pentagrid Mixer Amplifier	7-pin O.	H	Htr.	6.3	0.3	Screen-Grid R.F. Amplifier	250	-3.0	100	5.5	5.3	800000	1100	—	—	—	6L7				
							Mixer	250	-6.0	150	8.3	3.3							exceeds 1.0 meg.	Oscillator-grid (No. 3) voltage = -15.0		
6N6 MG	Direct-Coupled Power Amplifier	7-pin O.	N	Htr.	6.3	0.8	Class-A Amplifier	300	0	—	6 <sup>5</sup>	45	24100	2400	58	7000	4.0	6N6 MG				
							Push-Pull Amplifier	400	-13	—	4.5 <sup>5</sup>	40							—	—	10000	20
6N7	Twin Triode Amplifier	8-pin O.	L	Htr.	6.3	0.8	Class-B Amplifier	250 300	0 0	— —	— —	Power output is for one tube at stated load, plate-to-plate			8000 10000	8.0 10.0	6N7					
6Q7	Duplex-Diode High- $\mu$ Triode	7-pin O.	I	Htr.	6.3	0.3	Triode Amplifier	250	-3	—	—	1.1	58000	1200	70	—	—	6Q7				
6R7	Duplex-Diode Triode	7-pin O.	I	Htr.	6.3	0.3	Triode Amplifier	250	-9	—	—	9.5	8500	1900	16	10000	0.28	6R7				

<sup>1</sup> Refer to Fig. 518.

<sup>2</sup> O.—small octal base.

<sup>3</sup> Screen tied to plate.

<sup>4</sup> Zero signal currents per tube.

<sup>5</sup> Subscript 1 indicates no grid-current flow.

Subscript 2 indicates grid-current flow over part of input cycle.

<sup>6</sup> Zero-signal currents, two tubes.

TABLE IV—2.0-VOLT BATTERY RECEIVING TUBES

Type	Name	Base <sup>3</sup>	Socket Connections <sup>1</sup>	Cathode	Fil. or Heater		Use	Plate Supply Volts	Grid Bias	Screen Volts	Screen Current Ma.	Plate Current Ma.	Plate Resistance, Ohms	Mutual Conductance Micromhos	Amp. Factor	Load Resistance Ohms	Power Output Watts	Type
					Volts	Amps												
1A4	Variable- $\mu$ Tetrode R.F. Amplifier	4-pin S.	D	Fil.	2.0	0.06	R.F. Amplifier	180	-3.0 min.	67.5	0.7	2.3	960000	750	720	—	—	1A4
1A6	Pentagrid Converter	6-pin S.	V	Fil.	2.0	0.06	Converter	180	-3.0 min.	67.5	2.4	1.3	500000	Anode grid (No. 2) 135 max. volts; 2.3 ma. Grid Leak 50000 ohms				1A6
1B4	Tetrode R.F. Amplifier	4-pin S.	D	Fil.	2.0	0.06	R.F. Amplifier	180	-3.0	67.5	0.4	1.7	1200000	650	780	—	—	1B4
							Bias Detector	180	-6	67.5	Plate current adjusted to 0.2 ma. with no signal							
1B5	Duplex-Diode Triode	6-pin S.	X	Fil.	2.0	0.06	Triode Class-A Amplifier	135	-3.0	—	—	0.8	35000	575	20	—	—	1B5
1C6	Pentagrid Converter	6-pin S.	V	Fil.	2.0	0.12	Converter	180	-3.0 min.	67.5	2.0	1.5	750000	Anode grid (No. 2) 135 max. volts; 3.3 ma. Grid Leak 50000 ohms				1C6
1F4	Pentode Power Amplifier	5-pin M.	F	Fil.	2.0	0.12	Class-A Amplifier	135	-4.5	135	2.6	8	200000	1700	340	16000	0.34	1F4
1F6	Duplex-Diode Pentode	6-pin S.	EE	Fil.	2.0	0.6	R.F. Amplifier	180	-1.5	67.5	0.6	2.0	1000000	650	650	—	—	1F6
							A.F. Amplifier	135	-1.0	135	Plate resistor 0.25 megohm Screen resistor 1.0 megohm				Voltage Amp. = 48			
19	Twin-Triode Amplifier	6-pin S.	U	Fil.	2.0	0.26	Class-B Amplifier	135	0	—	—	—	Load plate-to-plate			10000	2.1	19
30	Triode Detector Amplifier	4-pin S.	A	Fil.	2.0	0.06	Class-A Amplifier	90	-4.5	—	—	2.5	11000	850	9.3	—	—	30
								135	-9.0			3.0	10300	900	9.3			
								180	-13.5			3.1	10300	900	9.3			
31	Triode Power Amplifier	4-pin S.	A	Fil.	2.0	0.13	Class-A Amplifier	135	-22.5	—	—	8.0	4100	925	3.8	7000	0.185	31
								180	-30.0			12.3	3600	1050	3.8	5700	0.375	
32	Tetrode R.F. Amplifier	4-pin M.	D	Fil.	2.0	0.06	Screen-Grid R.F. Amplifier	135	-3.0	67.5	0.4	1.7	950000	640	610	—	—	32
							180	-3.0	67.5	0.4	1.7	1200000	650	780				
33	Pentode Power Amplifier	5-pin M.	F	Fil.	2.0	0.26	Class-A Amplifier	180	-18.0	180	5.0	22.0	55000	1700	90	6000	1.4	33
								135	-13.5	135	3.0	14.5	50000	1450	70	7000	0.7	
34	Variable- $\mu$ Pentode R.F. Amplifier	4-pin M.	D <sup>2</sup>	Fil.	2.0	0.06	Screen-Grid R.F. Amplifier	135	-3.0 min.	67.5	1.0	2.8	600000	600	360	—	—	34
								180	—	67.5	1.0	2.8	1000000	620	620			
49	Dual-Grid Power Amplifier	5-pin M.	G	Fil.	2.0	0.12	Class-A Amplifier <sup>4</sup>	135	-20.0	—	—	6.0	4175	1125	4.7	11000	0.17	49
							Class-B Amplifier <sup>5</sup>	180	0	—	Power output for 2 tubes at indicated load, plate-to-plate				12000	3.5		
950	Pentode Power Amplifier	5-pin M.	F	Fil.	2.0	0.12	Class-A Amplifier	135	-16.5	1.35	2.0	7.0	100000	1000	100	13500	0.45	950

<sup>1</sup> Refer to Fig. 517.

<sup>2</sup> Suppressor grid connected to filament inside tube, not shown on base diagram.

<sup>3</sup> S.—small, M.—medium.

<sup>4</sup> Grid No. 2 tied to plate.

<sup>5</sup> Grids Nos. 1 and 2 tied together.

TABLE IV-A — 2.0-VOLT BATTERY TUBES WITH OCTAL BASES

Type	Name	Socket Connections <sup>1</sup>	Cathode	Fil. or Heater		Use	Plate Supply Volts	Grid Bias	Screen Volts	Screen Current Ma.	Plate Current Ma.	Plate Resistance, Ohms	Mutual Conductance Micromhos	Amp. Factor	Load Resistance Ohms	Power Output Watts	Type
				Volts	Amps												
1C7G	Pentagrid Converter	A	Fil.	2.0	0.06	Converter	—	—	Characteristics same as Type 1C6 — Table IV			—	—	—	—	1C7G	
1D5G	R.F. Amplifier-Variable- $\mu$	B	Fil.	2.0	0.06	R.F. Amplifier	—	—	Characteristics same as Type 1A4 — Table IV			—	—	—	—	1D5G	
1D7G	Pentagrid Converter	A	Fil.	2.0	0.06	Converter	—	—	Characteristics same as Type 1A6 — Table IV			—	—	—	—	1D7G	
1E5G	R.F. Amplifier	B	Fil.	2.0	0.06	R.F. Amplifier	—	—	Characteristics same as Type 1B4 — Table IV			—	—	—	—	1E5G	
1E7G	Double Pentode Power Amplifier	C	Fil.	2.0	0.24	Class-A Amplifier	135	-7.5	135	2.0 <sup>2</sup>	6.5 <sup>2</sup>	220,000	1600	350	24,000	0.65	1E7G
1F5G	Pentode Power Amplifier	D	Fil.	2.0	0.12	Class-A Amplifier	—	—	Characteristics same as Type 1F4 — Table IV			—	—	—	—	1F5G	
1F7G	Duplex-Diode Pentode	E	Fil.	2.0	0.06	Detector-Amplifier	—	—	Characteristic: same as Type 1F6 — Table IV			—	—	—	—	1F7G	
1H4G	Triode Amplifier	F	Fil.	2.0	0.06	Detector-Amplifier	—	—	Characteristics same as Type 30 — Table IV			—	—	—	—	1H4G	
1H6G	Duplex-Diode Triode	G	Fil.	2.0	0.06	Detector-Amplifier	—	—	Characteristics same as Type 1B5 — Table IV			—	—	—	—	1H6G	
1J6G	Twin Triode	H	Fil.	2.0	0.24	Class-B Amplifier	—	—	Characteristics same as Type 19 — Table IV			—	—	—	—	1J6G	

<sup>1</sup> Refer to Fig. 518-A.

<sup>2</sup> Total current for both sections; no signal.

TABLE V—SPECIAL TUBES

Type	Name	Base <sup>3</sup>	Socket Connections <sup>1</sup>	Cathode	Fil. or Heater		Use	Plate Supply Volts	Grid Bias	Screen Volts	Screen Current Ma.	Plate Current Ma.	Plate Resistance, Ohms	Mutual Conductance Micromhos	Amp. Factor	Load Resistance Ohms	Power Output Watts	Type	
					Volts	Amps													
12A5	Pentode Power Amplifier	7-pin M.	AA	Htr.	12.6	0.3	Class-A Amplifier	100 180	-15 -27	100 180	4.0 9.0	18 40	— —	— —	— —	5000 4500	0.7 2.8	12A5	
12A7	Rectifier-Pentode Power Amplifier	7-pin M.	FF	Htr.	12.6	0.3	Class-A Amplifier	135	-13.5	135	2.5	9.0	102000	975	100	13500	0.55	12A7	
							Half-Wave Rectifier	125 Max. Volts R.M.S. Output current 30 ma. Max.											
25A6 25A6G	Pentode Power Amplifier	7-pin O.	E <sup>7</sup>	Htr.	25	0.3	Class-A Amplifier	95 135 180	-15 -20 -20	95 135 135	4 8 7.5	20 37 38	45000 35000 40000	2000 2450 2500	90 85 100	4500 4000 5000	0.9 2.0 2.75	25A6 25A6G	
25B6G	Pentode Power Amplifier	7-pin O.	E <sup>7</sup>	Htr.	25	0.3	Class-A Amplifier	95	-15	95	4	45	—	4000	—	2000	1.75	25B6G	
43	Pentode Power Amplifier	6-pin M.	M <sup>2</sup>	Htr.	25.0	0.3	Class-A Amplifier	95 135	-15.0 -20.0	95 135	4.0 7.0	20.0 34.0	45000 35000	2000 2300	90 80	4500 4000	0.90 2.00	43	
48	Tetrode Power Amplifier	6-pin M.	M	Htr.	30.0	0.4	Class-A Amplifier	96 125	-19.0 -20.0	96 100	9.0 9.5	52.0 56.0	— —	3800 3900	— —	1500 1500	2.0 2.5	48	
864	Triode Amplifier	4-pin S.	A	Fil.	1.1	0.25	Class-A Amplifier	90 135	-4.5 -9.0	— —	— —	2.9 3.5	13500 12700	610 645	8.2 8.2	— —	— —	864	
885	Gas Triode	5-pin S.	H	Htr.	2.5	1.4	Sweep-Circuit Oscillator	200	—	—	—	0.5	Tube voltage drop 15 v.				—	—	885
							Class-A Amplifier	250	-3	100	0.7	2.0	Exceeds 1.5 megohms	1400	Exceeds 2000	—	—	—	—
954 <sup>4</sup>	Pentode Detector, Amplifier	None	—	Htr.	6.3	0.15	Bias Detector	250	-6	100	—	—	Plate current to be adjusted to 0.1 ma. with no signal				—	—	954
							Class-A Amplifier	180	-5	—	—	4.5	12500	2000	25	20000	0.135	955	
							Oscillator	180	-35	—	—	7	D.C. Grid Current App 1.5 ma.				0.5		
1603	Triple-Grid Detector Amplifier (Low Noise)	6-pin M.	J	Htr.	6.3	0.3	Class-A Pentode Amplifier	100 250	-3 -3	100 100	0.5 0.5	2.0 2.0	1000000 1500000	1185 1225	1185 1500	— —	— —	—	
							Class-A Triode Amplifier <sup>5</sup>	180 250	-5.3 -8.0	— —	— —	5.3 6.5	11000 10500	1800 1900	20 20	— —	— —		
							Characteristics same as Type 10. Isclantite Base												RK10
RK15	Triode Power Amplifier	4-pin M.	A <sup>5</sup>	Fil.	2.5	1.75	Characteristics same as Type 46 with Class-B connections											RK15	
RK16	Triode Power Amplifier	5-pin M.	H	Htr.	2.5	2.0	Characteristics same as Type 59 with Class-A triode connections											RK16	
RK17	Pentode Power Amplifier	5-pin M.	I <sup>2</sup>	Htr.	2.5	2.0	Characteristics same as Type 2A5											RK17	
RK24	Triode Amplifier	4-pin M.	A	Fil.	2.0	0.12	Class-A Amplifier	180	-13.5	—	—	8.0	5000	1600	8.0	12000	0.25	RK24	
							Oscillator	180	-45	—	—	20	Grid leak 10000 ohms				—		

Vacuum Tubes

TABLE V—SPECIAL TUBES—Continued

Type	Name	Base <sup>3</sup>	Socket Connections <sup>1</sup>	Cathode	Fil. or Heater		Use	Plate Supply Volts	Grid Bias	Screen Volts	Screen Current Ma.	Plate Current Ma.	Plate Resistance, Ohms	Mutual Conductance Micromhos	Amp. Factor	Load Resistance Ohms	Power Output Watts	Type
					Volts	Amps												
RK33	Dual Triode	7-pin S.	GG	Htr.	6.3	0.6	Class-A Amplifier (Single section)	250	-16.5	—	—	8	875	1200	10.5	2000	—	RK33
							Class-C Amp. or Osc. (Single section)	250	—	—	20	Plate Dissipation 2.5 watts			3			
RK34	Twin Triode Amplifier	5-pin M. 7-pin M.	DD <sup>6</sup>	Htr.	6.3	0.8	Class-B Amplifier	180 300	-6 -15	—	—	—	Power Output for one tube at stated load, plate to plate			6000 10000	7.2 12.0	RK34
RK100	Mercury-vapor Triode	6-pin M.	CC	Htr.	6.3	0.6	Amplifier	100	-2.5	Cathode (G1) current 250 ma.			20000	50	—	—	RK100	

<sup>1</sup> Refer to Fig. 517.  
<sup>2</sup> Suppressor grid, connected to filament inside tube, not shown on base diagram.  
<sup>3</sup> M.—medium, S.—small.  
<sup>4</sup> "Acorn" type; miniature unbase tubes for ultra-high frequencies.  
<sup>5</sup> Grid connection to top cap; no connection to No. 3 pin.  
<sup>6</sup> Early models; later tubes have 7-pin bases. Connections same as Fig. 517-T except that pins 2 and 6 are unconnected; plate leads brought out to top caps.  
<sup>7</sup> Fig. 518.  
<sup>8</sup> Grids Nos. 2 and 3 connected to plate.

TABLE VI—MISCELLANEOUS RECEIVING TUBES

Type	Name	Base <sup>2</sup>	Socket Connections <sup>1</sup>	Cathode	Fil. or Heater		Use	Plate Supply Volts	Grid Bias	Screen Volts	Screen Current Ma.	Plate Current Ma.	Plate Resistance, Ohms	Mutual Conductance Micromhos	Amp. Factor	Load Resistance Ohms	Power Output Watts	Type
					Volts	Amps												
'00-A	Triode Detector	4-pin M.	A	Fil.	5.0	0.25	Grid Leak Detector	45	—	—	—	1.5	30000	666	20	—	—	'00-A
01-A	Triode Detector Amplifier	4-pin M.	A	Fil.	5.0	0.25	Class-A Amplifier	90	-4.5	—	—	2.5	11000	725	8.0	—	—	01-A
								135	-9.0			3.0	10000	800	8.0			
10	Triode Power Amplifier	4-pin M.	A	Fil.	7.5	1.25	Class-A Amplifier	350	-31.0	—	—	16.0	5150	1550	8.0	11000	0.9	10
								425	-39.0			18.0	5000	1600	8.0	10200	1.6	
12	Triode Detector Amplifier	4-pin M.	A	Fil.	1.1	0.25	Class-A Amplifier	90	-4.5	—	—	2.5	15500	425	6.6	—	—	12
								135	-10.5			3.0	15000	440	6.6			
20	Triode Power Amplifier	4-pin S.	A	Fil.	3.3	0.132	Class-A Amplifier	90	-16.5	—	—	3.0	8000	415	3.3	9600	0.045	20
								135	-22.5			6.5	6300	525	3.3	6500	0.110	
22	Tetrode R.F. Amplifier	4-pin M.	D	Fil.	3.3	0.132	Screen-Grid R.F. Amplifier	135	-1.5	45.0	0.6	1.7	725000	375	270	—	—	22
								135	-1.5	67.5	1.3	3.7	325000	500	160			
26	Triode Amplifier	4-pin M.	A	Fil.	1.5	1.05	Class-A Amplifier	90	-7.0	—	—	2.9	8900	935	8.3	—	—	26
								180	-14.5			6.2	7300	1150	8.3			
40	Triode Voltage Amplifier	4-pin M.	A	Fil.	5.0	0.25	Class-A Amplifier	135	-1.5	—	—	0.2	150000	200	30	—	—	40
								180	-3.0			0.2	150000	200	30			
50	Triode Power Amplifier	4-pin M.	A	Fil.	7.5	1.25	Class-A Amplifier	300	-54.0	—	—	35.0	2000	1900	3.8	4600	1.6	50
								400	-70.0			55.0	1800	2100	3.8	3670	3.4	
								450	-84.0			55.0	1800	2100	3.8	4350	4.6	
71-A	Triode Power Amplifier	4-pin M.	A	Fil.	5.0	0.25	Class-A Amplifier	90	-19.0	—	—	10.0	2170	1400	3.0	3000	0.125	71-A
								180	-43.0			20.0	1750	1700	3.0	4800	0.790	
99	Triode Detector Amplifier	4-pin S.	A	Fil.	3.3	0.063	Class-A Amplifier	90	-4.5	—	—	2.5	15500	425	6.6	—	—	99
112A	Triode Detector Amplifier	4-pin M.	A	Fil.	5.0	0.25	Class-A Amplifier	90	-4.5	—	—	5.0	5400	1575	8.5	—	—	112A
								180	-13.5	—	—	7.7	4700	1800	8.5	—	—	

<sup>1</sup> Refer to Fig. 517.  
<sup>2</sup> M.—medium, S.—small.



# Vacuum Tubes

TABLE VII — RECTIFIERS — RECEIVING AND TRANSMITTING

Type No.	Name	Base <sup>2</sup>	Socket Connections <sup>1</sup>	Cathode	Fil. or Heater		Max. A.C. Voltage Per Plate	Max. D.C. Output Current Ma.	Max. Inverse Peak Voltage	Max. Peak Plate Current Ma.	Type <sup>7</sup>
					Volts	Amps.					
5W4	Full-Wave Rectifier	5-pin O.	A <sup>4</sup>	Fil.	5.0	1.5	350	110	1000	—	V
5X4G	Full-Wave Rectifier	8-pin O.	P <sup>4</sup>	Fil.	5.0	3.0	500	250	—	—	V
5Y3G	Full-Wave Rectifier	5-pin O.	A <sup>4</sup>	Fil.	5.0	2.0	Same as Type 80			V	
5Y4G	Full-Wave Rectifier	8-pin O.	P <sup>4</sup>	Fil.	5.0	2.0	Same as Type 80			V	
5Z3	Full-Wave Rectifier	4-pin M.	B	Fil.	5.0	3.0	500	250	—	—	V
5Z4	Full-Wave Rectifier <sup>3</sup>	5-pin O.	A <sup>4</sup>	Htr.	5.0	2.0	400	125	1100	—	V
6X5 6X5G	Full-Wave Rectifier	6-pin O.	Q <sup>4</sup>	Htr.	6.3	0.5	350	60	—	—	V
12Z3	Half-Wave Rectifier	4-pin S.	R	Htr.	12.6	0.3	250	60	—	—	V
25Z5	Rectifier-Doubler	6-pin S.	E	Htr.	25.0	0.3	125	100	—	—	V
25Z6 25Z6G	Rectifier-Doubler	7-pin O.	R <sup>4</sup>	Htr.	25.0	0.3	125	100	—	—	V
1 <sup>5</sup>	Half-Wave Rectifier	4-pin S.	R	Htr.	6.3	0.3	350	50	1000	400	M
1-V <sup>5</sup>	Half-Wave Rectifier	4-pin S.	R	Htr.	6.3	0.3	350	50	—	—	V
80	Full-Wave Rectifier	4-pin M.	B	Fil.	5.0	2.0	350 400 550 <sup>6</sup>	125 110 135	—	—	V
81	Half-Wave Rectifier	4-pin M.	C	Fil.	7.5	1.25	700	85	—	—	V
82	Full-Wave Rectifier	4-pin M.	B	Fil.	2.5	3.0	500	125	1400	400	M
83	Full-Wave Rectifier	4-pin M.	B	Fil.	5.0	3.0	500	250	1400	800	M
83-V	Full-Wave Rectifier	4-pin M.	B	Htr.	5.0	2.0	400	200	1100	—	V
84/6Z4	Full-Wave Rectifier	5-pin S.	S	Htr.	6.3	0.5	350	50	—	—	V
RK19	Full-Wave Rectifier	4-pin M.	B <sup>8</sup>	Htr.	7.5	2.5	1250	—	3500	600	V
RK21	Half-Wave Rectifier	4-pin M.	A <sup>8</sup>	Htr.	2.5	4.0	1250	—	3500	600	V
RK22	Full-Wave Rectifier	4-pin M.	B <sup>8</sup>	Htr.	2.5	8.0	1250	—	3500	600	V
836	Half-Wave Rectifier	4-pin M.	A <sup>8</sup>	Htr.	2.5	5.0	—	—	5000	1000	V
866	Half-Wave Rectifier	4-pin M.	A <sup>8</sup>	Fil.	2.5	5.0	—	—	7500	1000	M
866-A	Half-Wave Rectifier	4-pin M.	A <sup>8</sup>	Fil.	2.5	5.0	—	—	10000	600	M
872	Half-Wave Rectifier	4-pin J.	P <sup>8</sup>	Fil.	5.0	10.0	—	—	7500	2500	M
872-A	Half-Wave Rectifier	4-pin J.	P <sup>8</sup>	Fil.	5.0	10.0	—	—	10000	2500	M

<sup>1</sup> Refer to Fig. 517 except as noted otherwise.  
<sup>2</sup> M.—medium; S.—small; O.—small octal; J.—jumbo.  
<sup>3</sup> Metal tube series.  
<sup>4</sup> Refer to Fig. 518.

<sup>5</sup> Types 1 and 1-V interchangeable.  
<sup>6</sup> With input choke of at least 20 henrys.  
<sup>7</sup> M.—Mercury-vapor type; V.—high-vacuum type.  
<sup>8</sup> Refer to Fig. 519.

TABLE VIII—TRIODE TRANSMITTING TUBES

Type	Max. Plate Dissipation Watts	Cathode		Max. Plate Voltage	Max. Plate Current Ma.	Max. D.C. Grid Current Ma.	Amp. Factor	Recommended Grid Leak Ohms	Interelectrode Capacitances (pfd.)			Base <sup>2</sup>	Socket Connections <sup>1</sup>	Typical Operation	Plate Voltage	Grid Voltage	Plate Current Ma.	D.C. Grid Current Ma.	Approx. Grid Driving Power Watts	Peak Power Output Watts	Approx. Carrier Output Power Watts	Type
		Volts	Amps.						Grid to Fil.	Grid to Plate	Plate to Fil.											
10*	15	7.5	1.25	500	60	15	8.0	10000	4.0	7.0	3.0	4-pin M.	C	Class-C Amplifier	500	-135	60	10	3	—	20	10
														Grid-Bias Modulated Amp.	500	—	45	1-2	1	30	7.5	
841	15	7.5	1.25	450	60	20	30.0	5000	4.0	7.0	3.0	4-pin M.	C	Class-C Amplifier	450	-32	50	12.5	1.25	—	14	841
843	15	2.5	2.5	450	40	7.5	7.7	10000	4.0	4.5	4.0	5-pin M.	D	Class-C Amplifier	450	-140	30	5	1	—	7.5	843
801*	20	7.5	1.25	600	70	15	8.0	10000	4.5	6.0	1.5	4-pin M.	C	Class-C Amp. (Telegraphy)	600	-150	65	15	4	—	25	801
														Class-C Amp. (Telephony)	500	-190	55	15	4.5	—	18	
														Class-B Amp. (Telephony)	600	-75	45	—	—	30	7.5	
														Grid-Bias Modulated Amp.	600	—	50	2	2	40	10	
316A*	30	20	3.65	450	80	12	6.5	—	1.2	1.6	0.8	None <sup>3</sup>	—	Class-C Amp. (Telegraphy)	450	—	80	12	—	—	7.5	316A
														Class-C Amp. (Telephony)	400	—	80	12	—	—	6.5	
800*	35	7.5	3.25	1250	115	25	15	10000	2.75	2.5	1.0	4-pin M.	E	Class-C Amp. (Telegraphy)	1250	-175	70	15	4	—	65	800
														Class-C Amp. (Telephony)	1000	-200	70	15	4	—	50	
														Class-B Amp. (Telephony)	1000	-55	42	—	—	56	14	
														Grid-Bias Modulated Amp.	1000	-150	50	4-5	2	60	15	
RK35*	35	7.5	3.25	1250	100	—	—	10000	3.5	2.7	0.4	4-pin M.	E	Class-C Amp.	1000	-320	96	15	6.5	—	61	RK35
														Class-B Amp. (Telephony)	1000	-160	52	—	—	68	17	
														Grid-Modulated Amp.	1000	-240	50	—	2.6	64	16	
35T*	35	5.0	4.0	1500	100	25	30	4000	2.5	2.0	0.3	4-pin M.	F	Class-C Amplifier	500	-35	100	20	Power Output Ratings at 75% Eff.	—	38	35T
															1000	-65	100	20				
															1500	-100	100	20				
830	40	10.0	2.15	750	110	18	8.0	10000	4.9	9.9	2.2	4-pin M.	C	Class-C Amplifier	750	-180	110	18	7	—	55	830
														Grid-Bias Modulated Amp.	1000	-200	50	2	3	60	15	
RK18*	40	7.5	2.5	1250	85	15	18.0	10000	3.8	5.0	2.0	4-pin M.	F	Class-C Amplifier	1000	-135	85	10	5	—	50	RK18
RK31*	40	7.5	3.0	1250	85	15	—	5000	—	—	—	4-pin M.	F	Class-C Amplifier	1000	-50	85	15	5	—	50	RK31
825	40	7.5	2.0	850	110	25	8	10000	3.0	7.0	2.7	4-pin M.	C	Class-C Amplifier	—	—	—	—	—	—	50	825
756	40	7.5	2.0	850	110	20	25	5000	3.5	8.0	2.7	4-pin M.	C	Class-C Amplifier	—	—	—	—	—	—	60	756
304A*	50	7.5	3.25	1250	100	20	11.0	5000	2.0	2.5	0.7	4-pin M.	E	Class-C Amp. (Telegraphy)	1250	-200	100	—	—	—	85	304A
														Class-C Amp. (Telephony)	1000	-180	100	—	—	—	65	
														Class-B Amp. (Telephony)	1250	-110	50	—	—	84	21	
304B*	50	7.5	3.25	1250	100	25	11.0	5000	2.0	2.5	0.7	4-pin M.	E	Class-B Amp. (Telephony)	1250	-110	60	—	—	—	25	304B
														Class-C Amp. (Telegraphy)	1250	-200	100	—	—	—	85	
														Class-C Amp. (Telephony)	1000	-180	100	25	—	—	65	

The Radio Amateur's Handbook

TABLE VIII—Continued

Type	Max. Plate Dissipation Watts	Cathode		Max. Plate Voltage	Max. Plate Current Ma.	Max. D.C. Grid Current Ma.	Amp. Factor	Recommended Grid Leak Ohms	Inter-electrode Capacitances ( $\mu\text{fd.}$ )			Base <sup>2</sup>	Socket Connections <sup>1</sup>	Typical Operation	Plate Voltage	Grid Voltage	Plate Current Ma.	D.C. Grid Current Ma.	Approx. Grid Driving Power Watts	Peak Power Output Watts	Approx. Carrier Output Power Watts	Type
		Volts	Amps.						Grid to Fil.	Grid to Plate	Plate to Fil.											
834*	50	7.5	3.25	1250	100	25	10.5	5000	2.2	2.6	0.6	4-pin M.	E	Class-B Amp. (Telephony)	1250	-115	50	0	3	—	20	834
														Class-C Amp. (Telephony)	1000	-310	90	17.5	6.5	—	58	
														Class-C Amp. (Telegraphy)	1250	-225	90	15	4.5	—	75	
841A*	50	10.0	2.0	1250	150	30	14.6	5000	3.5	9.0	2.5	4-pin M.	F	Class-C Amplifier	—	—	—	—	—	—	85	841A
154*	50	5.0	6.5	1500	175	30	6.7	10000				4-pin M.	E	Class-B Amp. (Telephony)	750 1000 1500	— — —	— — —	— — —	5 5 5	— — —	18 25 28	154
														Class-C Amplifier	750 1000 1500	— — —	— — —	— — —	10-15 10-15 10-15	— — —	85 125 200	
														Class-C Amplifier	—	Output rating based on 75% Eff.					168	
T-55*	55	7.5	3.25	1500	150	40	20	2500	1.0	2.5	0.7	4-pin M.	F	Class-C Amplifier	—	Output rating based on 75% Eff.					168	T55
830B	60	10.0	2.0	1000	150	30	25	5000	5.0	11	1.8	4-pin M.	F	Class-B Amp. (Telephony)	1000	-35	85	6	6	—	26	830B
														Class-C Amp. (Telephony)	800	-150	95	20	5	—	50	
														Class-C Amp. (Telegraphy)	1000	-110	140	30	7	—	90	
HF100*	75	10.0	2.0	1500	150	30	21	5000	3.5	5	1.4	4-pin M.	E	Class-C Amplifier	Output rating based on 75% Eff.					170	HF100	
50T*	75	5.0	6.0	3000	100	30	12	10000	2.0	2.0	0.4	4-pin M.	E	Class-C Amplifier	1000 2000 3000	-200 -400 -600	100 100 100	25 25 25	Power Output Ratings at 75% Eff.		75 150 250	50T
														Class-C Amp. (Telegraphy)	1250	-125	150	25	7	—	130	
														Class-C Amp. (Telephony)	1000	-135	150	50	14	—	100	
203A	100	10.0	3.25	1250	175	60	25	5000	6.5	14.5	5.5	4-pin J.	M	Class-B Amp. (Telephony)	1250	-45	106	—	—	170	42.5	203A
														Class-C Amp. (Telegraphy)	1250	-225	150	18	7	—	130	
														Class-C Amp. (Telephony)	1000	-260	150	35	14	—	100	
211	100	10.0	3.25	1250	175	50	12	5000	6	14.5	5.5	4-pin J.	M	Class-B Amp. (Telephony)	1250	-100	106	—	—	170	42.5	211
														Class-C Amplifier	1000	-150	150	—	—	—	125	
														Class-B Amp. (Telephony)	1250	-100	100	—	—	—	125 31	
242A	100	10.0	3.25	1250	150	—	12.5	5000	6.5	13.0	4.0	4-pin J.	M	Class-C Amp. (Telegraphy)	1250	-80	150	30	6	—	130	242A
														Class-C Amp. (Telephony)	1000	-135	150	60	16	—	100	
														Class-B Amp. (Telephony)	1250	0	106	60	10	—	42.5	
838*	100	10.0	3.25	1250	175	70	—	3000	6.5	8.0	5.0	4-pin J.	M	Class-C Amp. (Telegraphy)	3000	-600	85	15	12	—	165	838
														Class-C Amp. (Telephony)	2000	-500	67	30	23	—	75	
														Class-B Amp. (Telephony)	3000	-250	43	—	—	—	160 40	
852*	100	10.0	3.25	3000	150	40	12	10000	1.9	2.6	1.0	4-pin M.	E	Class-C Amp. (Telegraphy)	3000	-500	85	15	12	—	165	852
														Class-C Amp. (Telephony)	2000	-500	67	30	23	—	75	
														Class-B Amp. (Telephony)	3000	-250	43	—	—	—	160 40	

Vacuum Tubes

TABLE VIII—TRIODE TRANSMITTING TUBES—Continued

Type	Max. Plate Dissipation Watts	Cathode		Max. Plate Voltage	Max. Plate Current Ma.	Max. D.C. Grid Current Ma.	Amp. Factor	Recommended Grid Leak Ohms	Interelectrode Capacitances (pfd.)			Base <sup>2</sup>	Socket Connections <sup>1</sup>	Typical Operation	Plate Voltage	Grid Voltage	Plate Current Ma.	D.C. Grid Current Ma.	Approx. Grid Driving Power Watts	Peak Power Output Watts	Approx. Carrier Output Power Watts	Type
		Volts	Amps.						Grid to Fil.	Grid to Plate	Plate to Fil.											
RK36*	100	5.0	8.0	3000	165	35	—	10000	4.5	5.0	1.0	4-pin M.	E	Class-C Amplifier	2000	-360	150	30	15	—	200	RK36.
														Class-B Amp. (Telephony)	2000	-180	75	—	10	200	50	
														Grid-Bias Modulated Amp.	2000	-270	72	—	3.5	—	42	
805*	125	10.0	3.25	1500	210	70	—	3000	8.5	6.5	10.5	4-pin J.	M <sup>4</sup>	Class-B Amp. (Telephony)	1500	-10	115	15	7.5	—	57.5	805
														Class-C Amp. (Telephony)	1250	-160	160	60	16	—	140	
														Class-C Amp. (Telegraphy)	1500	-105	200	40	8.5	—	215	
354*	150	5.0	10.0	4000	285	50	14	10000	9.0	4.0	0.2	4-pin J.	M <sup>4</sup>	Class-C Amplifier	1500 2500 3500	-400 -800 -1200	285 285 285	50 40 36	30 40 53	— — —	390 580 850	354
														Class-B Amp. (Telephony)	2000 2500 3000	-155 -188 -233	84 88 82	— — —	11 13 15	— — —	50 70 81	
HF200*	150	11.0	3.4	2000	200	50	18	10000	5.2	5.8	1.2	4-pin J.	N	Class-C Amplifier	Output rating based on 75% Eff.					300	HF200	
M150T*	150	5.0	10.0	3000	200	50	13	10000	3.0	3.5	0.5	4-pin J.	N	Class-C Amplifier	1000 2000 3000	-200 -400 -600	200 200 200	35 35 35	Power Output Based on 75% Eff.		150 300 450	150T
T155*	155	10.0	4.0	3000	200	60	20	5000	2.5	3.0	1.0	4-pin J.	N	Class-C Amplifier	Output rating based on 75% Eff.					450	T155	
F108A*	175	10.0	11.0	3000	200	50	12	15000	3.0	7.0	2.0	4-pin J.	N	Class-C Amplifier	3000	-350	200	—	—	—	400	F108A
HF300*	200	12.0	4.0	2200	275	50	23	5000	6.0	6.5	1.4	4-pin J.	N	Class-C Amplifier	Output rating based on 75% Eff.					450	HF300	
814	200	10.0	4.0	2500	300	75	12	10000	7.0	13.0	5.5	4-pin J.	M <sup>4</sup>	Class-C Amplifier	Output rating at 2000 volts					400	814	
822	200	10.0	4.0	2500	300	60	27	5000	8.0	14.0	6.0	4-pin J.	M <sup>4</sup>	Class-C Amplifier	Output rating at 2000 volts					400	822	
T200*	200	11.0	4.0	2500	350	80	16.6	10000	5.0	7.0	3.0	4-pin J.	N	Class-C Amplifier	Output rating based on 75% Eff.					500	T200	
204A	250	11.0	3.85	2500	275	80	25	5000	12.5	15.0	2.3	Special	Q	Class-C Amp. (Telegraphy)	2000	-175	250	—	—	—	350	204A
														Class-C Amp. (Telephony)	1800	-250	250	—	—	—	300	
														Class-B Amp. (Telephony)	2000	-70	160	—	—	400	100	
300T*	300	8.0	11.5	3500	350	75	16	10000	4.0	4.0	0.6	4-pin J.	N	Class-C Amplifier	1500 2500 3500	-250 -400 -600	300 300 300	60 60 60	Power Output Ratings at 75% Eff.		340 560 800	300T
849	400	11.0	5.0	2500	350	125	19	5000	17	33.5	3	Special	Q	Class-C Amp. (Telegraphy)	2000	-200	300	—	—	—	450	849
														Class-B Amp. (Telephony)	1800	-300	300	—	—	—	390	
														Class-B Amp. (Telephony)	2000	-95	265	—	—	700	175	
831*	400	11.0	10.0	3500	350	75	14.5	10000	3.8	4.0	1.4	Special	R	Class-C Amplifier	3500	-400	275	40	30	—	590	831
F100*	500	11.0	25.0	2000	500	—	14.0	10000	4.0	10	2.0	Special	R	Class-C Amplifier	2000	-300	500	—	—	—	600	F100
500T*	500	8.0	20.0	4000	600	125	13.5	10000	6.0	4.5	0.8			Class-C Amplifier	2000	-400	450	100	—	—	650	500T

1 Refer to Fig. 519.  
 2 M.—medium, J.—jumbo.  
 3 All wire leads. Ratings at 500 mc.  
 4 Plate connection to tap cap.  
 \* Especially suited to high-frequency use.

TABLE IX — TETRODE AND PENTODE TRANSMITTING TUBES

Type	Max. Plate Dissipation Watts	Cathode		Max. Plate Voltage	Max. Screen Voltage	Max. Screen Dissipation Watts	Interelectrode Capacitances ( $\mu\text{u.f.d.}$ )			Base ?	Socket Connections <sup>1</sup>	Typical Operation	Plate Voltage	Screen Voltage	Suppressor Voltage	Grid Voltage	Plate Current Ma.	Screen Current Ma.	Grid Current Ma.	Screen Resistor	Approx. Grid Driving Power Watts	Approx. Carrier Output Power Watts	Type
		Volts	Amps.				Grid to Fil.	Grid to Plate	Plate to Fil.														
802*	10	6.3	0.95	500	250	6	12	0.15	8.5	7-pin M.	G	Class-C Amp. (Telegraphy)	500	250	40	-100	45	12	2	20000	0.25	16	802
												Grid-Modulated Amp.	500	200	0	-130	25	8	1	37500	0.8	4	
												Suppressor-Modulated Amp.	500	200	-45	-90	22	28	4.5	10700	0.5	3.5	
												Class-B Amp. (Telephony)	500	200	0	-28	25	7	—	43000	0.18	3.5	
RK23* RK25*	12	2.5 6.3	2.0 0.8	500	200	6	10.0	0.04	10.0	7-pin M.	G	Class-C Amplifier	500	200	45	-100	48	15	—	—	—	15	RK23 RK25
												Suppressor-Modulated Amp.	500	150	-30	-75	30	20	7.5	—	—	3	
844	15	2.5	3.25	500	175	3	9.5	0.15	7.5	5-pin M.	H	Class-C Amplifier	500	175	—	-125	25	—	—	—	—	9	844
865*	15	7.5	2.0	750	125	3	8.5	0.1	8.5	4-pin M.	I	Class-C Amp. (Telegraphy)	750	125	—	-80	40	—	5.5	45000	1.0	16	865
												Class-C Amp. (Telephony)	500	125	—	-120	40	—	9	20000	2.5	10	
												Class-B Amp. (Telephony)	750	125	—	-30	22	—	—	45000	—	4.5	
307A*	15	5.5	1.0	500	250	6	15	0.55	12	5-pin M.	J	Suppressor-Modulated Amp.	500	200	-50	-35	40	20	1.5	14000	—	6	307A
												Class-C Amp. (Telegraphy)	500	250	0	-35	60	13	1.4	20000	—	20	
254A*	20	5.0	3.25	750	175	5	4.6	0.1	9.4	4-pin M.	I	Class-C Amplifier	750	175	—	-90	60	—	—	—	—	25	254A
254B*	25	7.5	3.25	750	150	5	11.2	0.085	5.4	4-pin M.	I	Class-C Amplifier	750	150	—	-135	75	—	—	—	—	30	254B
RK20*	40	7.5	3.0	1250	300	15	11	0.012	10	5-pin M.	J	Class-C Amp. (Telegraphy)	1250	300	45	-100	92	32	5	26000	0.9	80	RK20
												Class-C Amp. (Telephony)	900	300	0	-100	62	50	6	25000	1.1	35	
												Grid-Modulated Amp.	1250	300	45	-140	44	10	1.8	95000	2.0	21	
												Suppressor-Modulated Amp.	1250	300	-40	-100	47	36	5	25000	0.9	21	
												Class-B Amp. (Telephony)	1250	300	0	-30	43	15	—	60000	0.5	16	
804*	40	7.5	3.0	1250	300	10	16	0.01	14.5	5-pin M.	J	Class-B Amp. (Telephony)	1250	300	45	-20	45	11	1	—	0.25	16	804
												Suppressor-Modulated Amp.	1250	—	-50	-100	48	35	7	27000	0.85	21	
												Grid-Modulated Amp.	1250	300	45	-115	45	11	2	—	0.85	21	
												Class-C Amp. (Telephony)	1000	—	50	-90	75	20	6	37000	0.65	50	
												Class-C Amp. (Telegraphy)	1250	300	45	-100	92	27	7	—	0.9	80	

TABLE IX—TETRODE AND PENTODE TRANSMITTING TUBES—Continued

Type	Max. Plate Dissipation Watts	Cathode		Max. Plate Voltage	Max. Screen Voltage	Max. Screen Dissipation Watts	Interelectrode Capacitances ( $\mu\text{fd.}$ )			Base <sup>2</sup>	Socket Connections <sup>1</sup>	Typical Operation	Plate Voltage	Screen Voltage	Suppressor Voltage	Grid Voltage	Plate Current Ma.	Screen Current Ma.	Grid Current Ma.	Screen Resistor	Approx. Grid Driving Power Watts	Approx. Carrier Output Power Watts	Type
		Volts	Amps.				Grid to Fil.	Grid to Plate	Plate to Fil.														
305A*	60	10	3.1	1000	200	6	10.5	0.14	5.4	4-pin M.	A <sup>3</sup>	Class-B Amp. (Telephony)	1000	200	—	-135	90	—	—	—	—	30	305A
												Class-C Amp. (Telegraphy)	1000	200	—	-200	125	—	—	—	85		
												Class-C Amp. (Telephony)	800	200	—	-270	125	—	—	—	70		
282A*	70	10.0	3.0	1000	250	5	12.2	0.2	6.8	4-pin M.	I	Class-C Amplifier	1000	250	—	-150	100	—	—	—	—	60	282A
850	100	10.0	3.25	1250	175	10	17.0	0.2	26.0	4-pin J.	O	Class-C Amplifier	1250	175	—	-150	160	—	35	—	10	130	850
860*	100	10.0	3.25	3000	300	10	7.75	0.08	7.5	4-pin M.	K	Class-C Amp. (Telegraphy)	3000	300	—	-150	85	—	15	225000	7	165	860
												Class-C Amp. (Telephony)	2000	300	—	-225	67	—	30	100000	15	75	
												Class-B Amp. (Telephony)	3000	300	—	-50	43	—	—	225000	—	40	
RK28*	100	10.0	5.0	2000	400	35	15.5	0.02	5.5	5-pin J.	L	Class-C Amp. (Telegraphy)	2000	400	45	-100	140	60	10	26000	1.8	200	RK28
												Class-C Amp. (Telephony)	1500	400	0	-100	135	85	9	12000	1.6	100	
												Grid-Modulated Amp.	2000	400	45	-140	80	20	2.8	80000	3.0	75	
												Suppressor-Modulated Amp.	2000	400	-45	-100	85	85	11	20000	2.0	70	
												Class-B Amp. (Telephony)	2000	400	0	-38	75	30	—	55000	0.9	50	
												Class-C Amp. (Telephony)	2000	500	40	-30	160	42	16	36000	1.6	210	
803*	125	10	3.25	2000	600	30	15.5	0.15	28.5	5-pin J.	L	Grid-Modulated Amp.	2000	600	40	-80	80	15	4	—	2	53	803
												Suppressor-Modulated Amp.	2000	500	-135	-50	80	55	15	27000	1.6	53	
												Class-B Amp. (Telephony)	2000	600	40	-40	80	15	3	—	1.5	53	
861*	400	11.0	10.0	3500	600	35	17.0	0.1	13.0	Special	S	Class-C Amplifier	3500	600	—	-250	275	—	30	—	25	590	861

<sup>1</sup> Refer to Fig. 519.

<sup>2</sup> M. — medium; J. — jumbo.

<sup>3</sup> Plate, grid and screen connections brought out through bulb.

\* Especially suited to high-frequency use.

# 6

## Receiver Circuit Design

### PRINCIPLES OF REGENERATIVE AND SUPER-HETERODYNE TYPES

COMPLETE receiver circuits represent what might appear to be an infinite variety of types, and therefore are likely to be confusing when compared with each other. However, each is made up of combinations of elements which, taken by themselves, break down into a relatively small number of basic units. The purpose of this chapter is to describe the design features of these elemental units which can be combined in different arrangements to make up different types of receivers, and to show how related units work together. Complete combinations, with constructional details, will be given in the next following chapter.

#### Types of Receivers

● Two types of receivers meeting the requirements of general amateur work are the simple regenerative receiver (autodyne), and the superheterodyne. Special types for ultra-high frequency work, the superregenerative and the super-infragenerator, are treated in Chapter Thirteen. In the regenerative receiver there is r.f. feedback in the detector circuit with the amount of this regeneration controllable to give either high amplification and selectivity without oscillation, or to give these together with oscillation to provide the heterodyne for beat-note c.w. reception, as has been explained in Chapter Five. The simplest form of receiver (Fig. 601-A) would be just one tube in a regenerative detector circuit, although the output available from such an arrangement is so small as to be generally unsatisfactory. A single stage of audio amplification following the detector gives more satisfactory results. A still further improvement is a stage of tuned radio-frequency amplification preceding the detector (Fig. 601-B). This increases sensitivity and gives somewhat greater selectivity, provides helpful isolation of the regenerative detector from the antenna circuit and allows sensitivity control ahead of the detector circuit.

Whereas the regenerative receiver's r.f. circuits handle the signal at incoming frequency,

in the superheterodyne type receiver the incoming signal is converted to a lower radio frequency and then amplified in intermediate circuits prior to conversion to audio frequency in the second detector (Fig. 601-C). This method allows greater r.f. amplification and the attainment of higher selectivity, since both of these are more readily obtained in the intermediate-frequency (i.f.) amplifier. This applies particularly to the single-signal type superheterodyne, which obtains extremely high selectivity in the i.f. circuits either by means of a variable band-width quartz crystal filter or by controllable regeneration in an i.f. stage.

The regenerative and superheterodyne types are used almost exclusively on the lower-frequency amateur bands (1.75 through 30 mc.), but on the higher-frequency bands (56 mc. and upwards) the superregenerative and the super-infragenerator or S.I.G. (Figs. 601-D and 601-E) are more generally used. These types are described in Chapter Thirteen.

The simple regenerative type receiver is less complicated than the superheterodyne, of course, and is accordingly less expensive. Until one has gained experience it is advisable to work with the simpler receiver, progressing later to the superheterodyne type.

#### Receiver Performance Characteristics

● The three important general characteristics of a receiver are its selectivity, its sensitivity, its stability and its fidelity. These are interdependent, with selectivity the controlling factor. The *selectivity* is the receiver's ability to discriminate between signals of different frequencies. The *sensitivity* is the minimum r.f. voltage input required to give a specified useful output. The *stability* is the receiver's ability to maintain its output constant over a period of time with constant signal input. The *fidelity* is the proportionate response through the audio-frequency range required for a given type of communication.

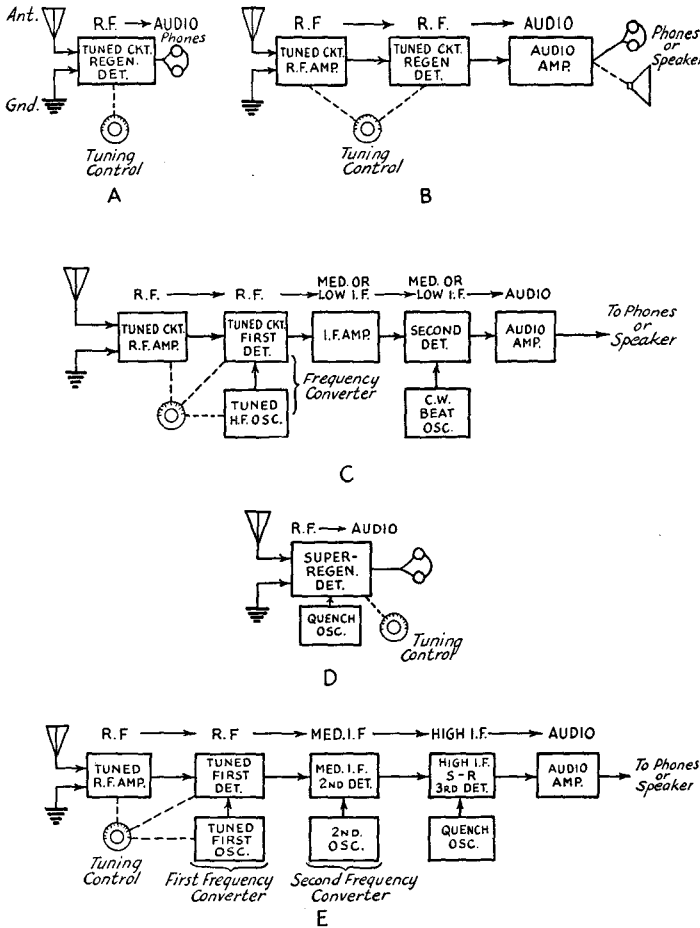

FIG. 601—BLOCK DIAGRAMS SHOWING THE ESSENTIAL UNITS OF BASIC RECEIVER TYPES. A, SIMPLE REGENERATIVE; B, TUNED R.F. REGENERATIVE; C, SUPERHETERODYNE; D, SUPER-REGENERATIVE; E, SUPER-INFREGENERATIVE. THE LAST TWO ARE ULTRA-HIGH FREQUENCY TYPES

## Selectivity

● The selectivity of a receiver is its most important characteristic, since it not only determines the receiver's ability to separate a desired signal of one radio-frequency from undesired signals of other frequencies, but also it affects the sensitivity of the receiver, as will be explained later. The selectivity of a given receiver is determined primarily by the resonance characteristic of its tuned circuits, in accordance with the fundamental principles of resonant circuits described in Chapter Four. It is also affected by the frequency characteristic of the audio-frequency circuits following

the final detector; in fact, audio-frequency selectivity may be quite effective in cases where deliberately tuned audio combinations are used for c.w. telegraph reception.

The selectivity of a receiver is usually described by an overall resonance curve such as that shown in Fig. 602. This represents the degree to which an undesired signal off resonance will be discriminated against as compared to the response to the desired signal on resonance; or, to put it differently, the curve shows how many times stronger than the desired signal an interfering signal off resonance must be to give receiver output equal to that given by the on-resonance desired signal. It should be noted that this resonance curve is plotted "upside down" as compared to the resonance curves shown in Chapter Four. It also should be noted that the response scale of microvolt input ratios is in logarithmic steps. The curve is plotted this way because it shows better the discrimination against undesired signals than would a "right-side-up" curve, and because the logarithmic scale enlarges

the input-ratio steps near resonance, where the selectivity characteristic is most important. The logarithmic microvoltage scale also corresponds with a uniform scale of decibel steps, the latter being noted at the right in Fig. 602. (Refer to the decibel chart and explanation in the Appendix.) This selectivity curve is for a standard amateur-type communication superheterodyne having 5 or 6 tuned i.f. circuits with transformer coupling, and represents typical selectivity for 'phone reception. It shows that an interfering signal 1.6 kc. off resonance would have to have twice the strength of the desired signal to give equal output, the curve being twice 1.6 kc. or 3.2 kc.



# Receiver Circuit Design

in width at "two times down". It also shows that at 3.75 kc. off resonance the interfering signal would have to be ten times as strong as the desired signal to give equal output, or that the interfering signal of the same field strength would be only one-tenth as effective as the desired signal.

## Sensitivity

● The sensitivity of a receiver is fundamentally limited by what is termed the "noise level". It is not simply a matter of amplification. Only signals that are readable above the noise background at the receiver output are useful. This noise background, which we may hear from the headset or loud speaker as a conglomeration of hum, "hiss", rattle and thumps, has its source in atmospheric disturbances or static, in commercial and domestic electrical equipment, and in the receiver itself. If there should be no external sources of noise interference, the receiver's own noise level would be the ultimate factor determining the receiver's effective sensitivity. This noise may be composed of hum from the power supply, and of hiss resulting from electronic variations in the conductors of the radio-frequency circuit and from irregularities which are inevitable in the electron flow within the radio-frequency vacuum-tube amplifier or detector. Other noises may result from imperfect condensers and resistors, poor connections, and the like. These, along with power-supply hum, should be negligible in a receiver of good design and construction. Thus the input circuit noise (*thermal agitation*), and the first tube noise (*shot effect, flicker effect, ionization*) remain as the ultimate noise limiting sensitivity, since the noise is amplified subsequently with the signal. This noise takes the form of a "hiss" sound in the output of the receiver, which naturally increases in intensity when a radio signal is tuned in or when a carrier from a local oscillator is applied to beat with the multitude of noise components in the receiver's detector.

The minute overlapping impulses which go to make up this hiss noise are uniformly distributed over a given section of the radio-frequency spectrum, and combine in voltage at the receiver output as the square root of the sum of the squares of the individual pulse voltages. Hence, this type of noise is reduced when the width of the frequency pass-band of the receiver is reduced. From this it is evident that the selectivity of the receiver is highly important in determining the effective sensitivity as well as in giving it discrimination against unwanted radio signals. Actually, the

noise power output is directly proportional to the receiver's effective band-width, or inversely proportional to its selectivity; while the r.m.s. noise voltage output is proportional to the square-root of the effective band-width.

For describing the effective sensitivity of a receiver in terms of its own noise level, the term *noise equivalent* is used. *The noise equivalent (N.E.) of a receiver is the c.w. signal input in microvolts required to produce an output equal to the receiver noise output.* In amateur type superheterodynes of good modern design the noise equivalent should be below 0.5 microvolt for i.f. selectivity of the order shown by the curve of Fig. 602, and should be well below 0.1 microvolt for receivers with crystal-filter selectivity. The determination of the basic receiver noise by the input circuit is discussed later in this chapter, as are also methods of reducing both this type of noise and other types of noise originating external to the receiver.

## Stability

● The stability of a receiver is principally a matter of its ability to stay tuned to a steady

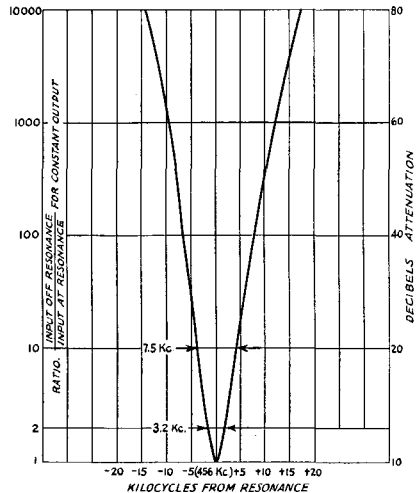

FIG. 602 — A TYPICAL RECEIVER SELECTIVITY CURVE OBTAINED BY PLOTTING MICROVOLTS INPUT, AT VARIOUS INTERMEDIATE FREQUENCIES, REQUIRED TO GIVE CONSTANT AUDIO OUTPUT. THE TEST SIGNAL IS OBTAINED FROM A STANDARD SIGNAL GENERATOR

signal once the controls have been set, and therefore essentially involves radio-frequency constancy. In regenerative receivers the stability of the detector circuit is of prime consideration, while in superheterodyne receivers oscillator stability is of first importance.

The frequency stability requirements become more rigorous with high selectivity, especially in receivers using crystal filters, since variations of but a few cycles can cause a relatively large change in output. The stability is affected by variation in temperature of the circuit elements, mechanical irregularities, supply voltage variations, and other factors, which require special consideration in designing the circuits.

### Fidelity

● The fidelity requirement in amateur receivers is essentially different from broadcast receiver requirements, although this is not generally realized, and is set by the minimum required for intelligibility. For c.w. telegraph reception of hand-keyed signals (say up to 30 words per minute) adequate fidelity for intelligible reception can be obtained with selectivity such that the receiver's effective band width (the "measuring stick" for selectivity) is but 50 cycles or less; for 'phone reception with usable intelligibility the band width must be proportionately greater, of course, although still considerably less than for good quality broadcast reception. It is therefore evident that the most important receiver characteristic is the effective selectivity; for the higher the selectivity, the greater can be the amplification and the higher the effective sensitivity, to the limits imposed by the requirement of intelligible output.

### Tuning Systems

● Since the amateur frequency-bands comprise narrow slices of territory widely separated, it is not possible to cover them all effectively with one coil and condenser combination in the tuner. Many schemes have been evolved to provide interchangeable coils. The use of a tube-base or a special form of larger size plugging into a tube socket is almost universal in amateur built receivers. Coils of this type are pictured later on with the constructional details of the receivers in which they are used. Larger coils with a horizontal row of plugs fitting into a similarly-arranged row of sockets are also used in some cases. The important requirements are that the coils should be readily interchangeable; the contacts should be positive; the coils should be mechanically strong so they will not be deformed in handling; and they should be small in diameter in order to avoid the existence of an extensive magnetic field around them.

More complicated receivers, in which a number of tuned circuits must be changed for each range, employ coil switching systems and

plug-in "gangs" containing three or four coil units for each range. These units are hardly adaptable for amateur construction and are more economically purchased than they can be made up individually by the constructor.

### Band Spreading

● Tuning condensers used in high-frequency receivers are much smaller than those employed for the broadcast band and lower frequencies. A 350- or 250- $\mu\text{fd.}$  condenser will, at high frequencies, cover so wide a frequency range that tuning becomes extremely difficult. Many amateurs remove plates from standardized condensers to reduce the maximum capacity, or else use midget condensers, which can be obtained in a variety of capacities. If the receiver is to cover all frequencies between 20,000 and 3000 kc., common practice is to use a tuning condenser rated at 150  $\mu\text{fd.}$  with three plug-in coils, but even this arrangement crowds the amateur bands in very small proportions of the dial scale. Most amateurs prefer to spread each band over a large part of the dial.

The amateur bands are not entirely in harmonic relation, and therefore a condenser which spreads one band satisfactorily may not give the same spread on others. In order to make each band cover a large number of dial

divisions, the ratio of maximum to minimum capacity must be different for each band.

Several widely used band-spreading schemes are shown in Fig. 603. At A is the parallel-condenser method.  $C_1$  is the tuning condenser, usually with a maximum capacity of about 25  $\mu\text{fd.}$   $C_2$  is a "band-setting" condenser; its maximum capacity should be at least 100  $\mu\text{fd.}$  and may be larger. The setting of  $C_2$  will determine the minimum capacity of the circuit, and the maximum capacity will be the maximum capacity of  $C_1$  plus the setting of  $C_2$ . A different maximum-to-minimum capacity

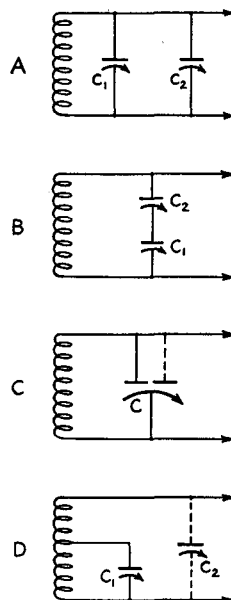

FIG. 603 — ESSENTIALS OF FOUR POPULAR BAND-SPREAD TUNING SYSTEMS

## Receiver Circuit Design

ratio can be chosen to give good band-spreading on each band.

The series-condenser method is shown at B. As explained in Chapter Three, the total capacity of two condensers in series is less than that of either.  $C_1$  again is the tuning condenser. It should have 100 $\mu$ fd. or more maximum capacity.  $C_2$  is the band-setting condenser and is preferably small, perhaps 25  $\mu$ fd. The maximum-minimum capacity ratio in the circuit will be determined by the setting of  $C_2$ . The minimum capacity changes very little for any setting of  $C_2$ , but the maximum capacity can be varied over quite a range, depending upon the ratios of the capacities of the two condensers.

At C is another arrangement which makes use of a "split-stator" tuning condenser — one with two separate stationary-plate sections and a single rotor. One of the stator sections is made small enough to give good band spreading on the 14- and 7-megacycle bands, and the second stator section, when connected in parallel with the small stator, will give good spread on 3500- and 1750-kc. The dotted connection for the two lower-frequency bands shown in C can be made by using a jumper in the low-frequency coil forms, the change being automatically made when the coils are plugged in.

The tapped-coil system at D is used in several manufactured amateur-band receivers and has also been adopted by a number of amateurs in home-built sets. Condenser  $C_1$  may be fairly large — 100  $\mu$ fd. or so — but will give good spread on any band if the right size of coil is chosen and the tap to which the stator plates of the condenser are connected is made at the right place. Trimmer condenser  $C_2$  may be a panel-controlled "band-set" condenser for shifting to ranges outside the amateur bands, as illustrated in the next chapter. It should have a maximum capacity of 25 to 100  $\mu$ fd.

### Circuit Constants

● The frequency range covered by a coil and condenser combination will be determined by the inductance of the coil across which the capacitance is effective, the minimum value of the effective capacitance and the maximum value of the capacitance. The inductance will, of course, be determined principally by the number of turns, length of winding and diameter of the coil, but will be affected more or less by coupling to another coil and by the presence of shielding and other conductors in its field. For practical purposes the value of inductance calculated either by the formulas given in the

Appendix or by the *Lightning Radio Calculator* can be taken, provided the shielding is spaced from the coil by a distance equal to the coil radius.

The maximum frequency limit for a given coil will be set by the minimum capacitance, which includes the minimum of the tuning condenser plus the tube and stray circuit capacitance. An allowance of 20 to 30  $\mu$ fd. usually can be assumed for this minimum. This is increased by "loading" with a trimmer condenser, or a "tank" condenser, in parallel with the main tuning condenser. There is an almost infinite variety of combinations possible, of course, which accounts for the wide differences in tuning combinations given for receivers of various designs. Typical values of constants for high-frequency and broadcast ranges are given in the table of Fig. 617 and in the descriptions of Chapter Seven. It is evident that full band-spread of each of the four bands with a single tuning capacitance range requires a relatively tremendous minimum capacitance on the 7- and 14-mc. bands. For this reason some compromise is usual in amateur-built receivers, the spread being somewhat less on the high-frequency bands. Several manufactured receivers and tuner units, however, achieve nearly full spread on all bands without resort to excessively high minimum capacitance. One method combines the features of the Fig. 603-A and 603-B systems, using a trimmer condenser in parallel with the coil to raise the minimum capacitance, and another condenser in series with the main tuning condenser to restrict the maximum capacitance value to the proper value. A series condenser has relatively small effect on the minimum capacitance, since the minimum of the tuning condenser usually will be considerably smaller than the series capacitance. Therefore the reduction by the series method is principally effective at maximum of the tuning capacitance. Such series combinations are more widely used in superheterodyne tuning systems, as will be shown later.

### Regenerative Detector Circuits

● In the regenerative receiver almost any one of a number of arrangements of the tickler coil and feed-back control in the detector circuit can be depended upon to give similarly loud signals, but some of them have the advantage of being more convenient and of better stability, permitting adjustment of regeneration without detuning the signal. It is also a great advantage if the regeneration control is absolutely quiet in action; if it permits a gradual adjustment up to and past the point of oscilla-

tion; and if it permits the tube to oscillate gently all across the frequency band on which the receiver is working without the necessity for touching anything but the tuning control.

Fig. 604 shows the circuits of regenerative detectors of various types. Although they

differ in detail, each has provision for feeding back energy from the output (plate) circuit to the input (grid) circuit in proper phase to give regeneration, and each has means for controlling the amount of feedback. The circuit of A is for a triode tube with an adjustable resistor in the d.c. plate feed to vary the plate voltage on the tube and thus to control regeneration. The tickler, or feed-back winding, is in the plate r.f. circuit and is connected so that the r.f. current flowing through this coil induces voltage in phase with that in the tuned grid coil, in accordance with the principles given in the preceding chapter. If both coils are wound in the same direction, the plate connection is to the outside of the tickler coil when the grid connection is to the outside of the tuned circuit.

The circuit of B is for a screen-grid tube as the detector, regeneration being controlled by adjustment of the screen-grid voltage. The tickler is in the plate circuit. As in the circuit of A, the portion of the control resistor between the rotating contact and ground is by-passed by a large condenser (0.5  $\mu\text{f}$ . or more) to filter out scratching noise caused by variation in contact resistance when the arm is rotated. The screen-grid detector has somewhat greater gain than the triode, but requires more critical circuit adjustment. The tickler should be adjusted so that the tube just goes into strong oscillation at a screen voltage of approximately 30 volts. The circuit of C is also for a screen-grid type tube, but uses a variable by-pass condenser for regeneration control, the screen-grid voltage being fixed. This condenser usually has a maximum capacitance of 100 or 150  $\mu\text{f}$ . When the capacitance is too small the tube does not regenerate, but as it increases toward maximum the reactance between the positive-B side of the tickler and ground becomes smaller until a critical value is reached where there is sufficient feed-back to cause oscillation. This method of control is quiet and smooth in operation when the size of the tickler and coupling to the grid coil are carefully adjusted. However, it is somewhat inconvenient to install, since the condenser must be located to give a short connection to the tickler terminal, and it is less generally used than the resistor method of control.

The circuit of D differs from that of B only in that the feed-back winding is in the cathode-to-ground circuit, being actually part of the tuned circuit coil. This places it effectively in the plate circuit (plate to ground and thence to the cathode), so that the action is much the same. However, the tickler is also in the screen-to-cathode return circuit, and the screen

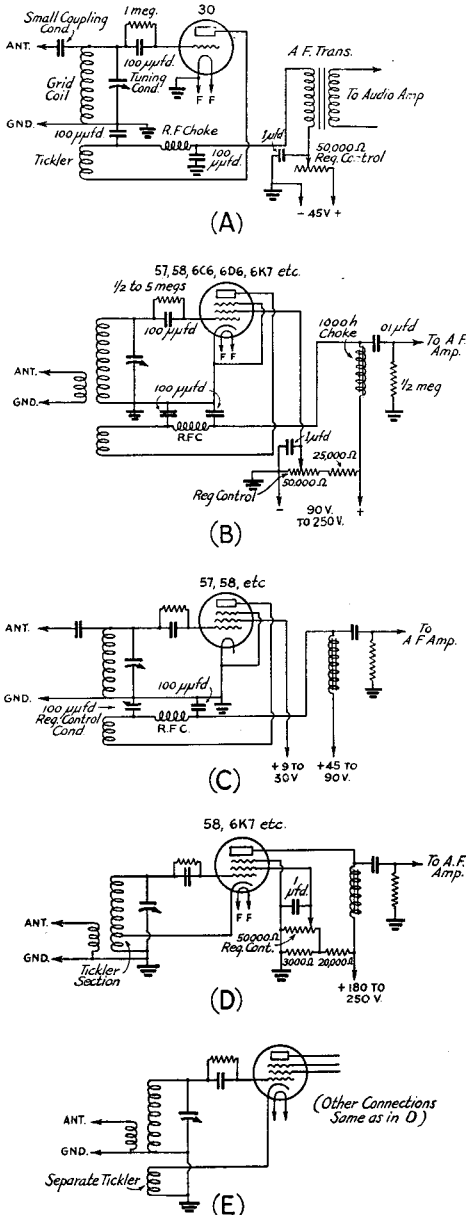

FIG. 604 — TRIODE AND PENTODE (SCREEN-GRID) REGENERATIVE DETECTOR CIRCUITS

# Receiver Circuit Design

operates to furnish feed-back as a sort of auxiliary plate. Hence a smaller tickler winding is required to give proper regeneration and oscillation. The circuit of E is the same as that of D, except that a separate feed-back winding is used. This eliminates the necessity of tapping the cathode into the main coil.

In all methods it is essential that the tickler be mounted or wound at the filament end and not the grid end of the tuning coil. In the interests of smooth control it will be found advisable to use just as few turns on the tickler as will allow the tube to oscillate easily all over the tuning range. If the tube starts oscillating with a sudden thump instead of a smooth rushing noise, a different value of grid leak resistance should be tried.

## Tuned Radio-Frequency Amplifiers

● A regenerative detector followed by a stage or two of audio-frequency amplification, when used for c.w. telegraphic work, will bring in amateur signals from all over the world on the higher frequencies. For such work, the sensitivity of this type of receiver usually proves to be ample. At times, however, a radio-frequency amplifier ahead of the detector is very desirable. The increase in sensitivity and selectivity provided by it can be put to good use in the reception of amateur radiotelephone signals. A further advantage of such an amplifier is that it isolates the detector from the antenna, reducing the radiation from the detector in an oscillating condition and making it impossible for the antenna, swaying in a wind, to cause the received signal to waver. A radio-frequency amplifier is also of considerable service in the elimination of "dead-spots" — points on the tuning dial at which the an-

tenna, coming into resonance, might otherwise stop the detector from oscillating.

The three-element tube is almost useless as a radio-frequency amplifier in the short-wave receiver. The modern screen-grid tube, however, is most effective providing the circuit in which it is used is a suitable one. The circuit of a tuned r.f. stage is shown in Fig. 605. Examples of modern practice in such tuned amplifier stages are also shown in the receivers described in the next chapter. When the r.f. amplifier uses a screen-grid tube of the variable- $\mu$  type (such as the 58, 78, 6D6, etc.) its gain can be made adjustable by means of a variable cathode resistor, additional to the usual fixed cathode resistor, as is also shown in Fig. 605. As the value of the resistance in series with the cathode is increased the voltage drop across it rises, making the bias applied to the grid increasingly negative with respect to the cathode and thereby reducing the amplification of the stage. Since the space current of the tube falls as the grid becomes more negative, thereby tending to lessen the rate of increase in negative bias with increasing resistance, it is advisable to provide a bleeder resistor from the cathode side of the gain control to a more positive point of the high-voltage supply such as the screen-grid voltage tap. Suitable resistance values for a single r.f. amplifier tube would be 300 to 500 ohms for the fixed cathode resistor, 10,000 ohms for the variable gain control resistor and 50,000 ohms for the bleeder. If the gain of several stages is to be controlled by the one variable resistor, its value can be proportionately less and the bleeder may be omitted.

Rather complete shielding is always required when the input circuit to the r.f. amplifier tube is tuned. For this reason the tuned r.f. type receiver is somewhat more costly and more difficult to build. In one form such a receiver has two separate tuning dials — one for the input circuit to the r.f. tube and one for the input circuit to the detector. The obvious inconvenience of tuning these two controls has led to the development of receivers in which the two tuning condensers are "ganged." The construction of a receiver of this type is a work requiring a little more skill, and had best be attempted after experience has been gained with the simpler types.

## Radio Frequency Shielding

● The purpose of shielding is to confine the magnetic and electrostatic fields about coils and condensers so that those fields cannot act on other apparatus, and to prevent external fields from acting upon them in turn. Chapter

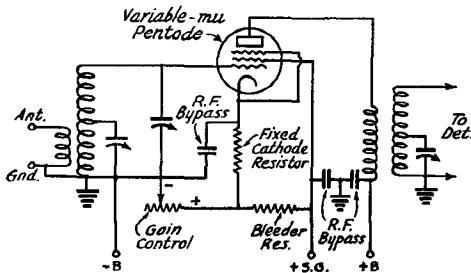

FIG. 605 — A TYPICAL RADIO-FREQUENCY AMPLIFIER CIRCUIT WITH BIAS GAIN CONTROL

It is suited to any of the variable- $\mu$  r.f. amplifier tubes such as the 58, 78, 6D6, 6K7, etc. With non-pentode types the suppressor-grid connection shown would be omitted. The value of the fixed cathode resistor will depend upon the tube type; values of the gain-control and bleeder resistors are discussed in the text.

Three has explained the nature of these fields. They can be confined by enclosing the apparatus about which the field exists in a metal box. The effectiveness of the shield depends upon the metal of which it is made and upon the completeness of contact at the joints. At radio frequencies the best shield is one made of a low-resistance non-magnetic metal, such as copper or aluminum, because the losses in it will be low. The high-frequency magnetic fields about the apparatus enclosed in the shield cause currents to flow in it, and since the flow of current is always accompanied by some loss of energy the shield in effect causes an increase in the resistance of the tuned circuit. The lower the resistance of the shielding material the lower will be the energy loss. At low frequencies, such as those in the audio range, copper and aluminum are ineffective for shielding.

The increase in resistance caused by shielding also depends upon the proximity of the apparatus inside the shield to the walls. Coils in particular should be spaced from the walls in all directions by a distance at least equal to the coil radius. For this reason small diameter coils are much to be preferred to large ones if the set is to be kept reasonably small. The losses in the shielding due to electrostatic fields are negligible in comparison to those caused by magnetic fields, so condensers can be mounted right on the walls of the shield if desired.

To be effective a shield must be grounded. Although an actual ground connection always will be best, it is sometimes sufficient to connect the shielding to a point in the receiver at zero r.f. potential, such as the negative side of the plate supply. Another point is that where shields completely enclose each amplifier stage or group of apparatus shielded, a single sheet of metal should not be used to form a common wall for two compartments, as shown in Fig. 606; such a wall may actually couple the two shielded groups or pieces of apparatus together instead of shielding them from each

other. A single metal sheet or "baffle" shield sometimes may be used between two circuits which are not completely enclosed, however.

There are two general methods of shielding. One is to group all the apparatus forming a single stage of amplification and put it in a single shield. The second method, exemplified in modern superhet receivers, is to use individual shields around each piece of apparatus, connecting them by mounting on a common metal base. Only those elements which are not at zero r.f. potential need be shielded. Each method will give good results, and the choice is usually dictated by mechanical considerations.

Although shielding is not necessary if no tuned r.f. amplifiers are used, it is often helpful. A metal cabinet about a simple receiver will prevent direct pick-up of signals by the coils and wiring of the set, and it will also minimize "induction hums" from unshielded house wiring.

## Audio-Frequency Amplifiers—Volume Control

● A power audio stage can be added to the receiver intended for headphone output where it is desired to operate a loud speaker. Alternatively, a power stage of sufficient power sensitivity can be substituted for the usual low-output amplifier following the detector. Several power amplifier combinations capable of a half-watt or more output are shown in Fig. 607, including pentodes of two types. The pentodes have greater power sensitivity than triodes (require less grid excitation for equal output) and are suited to connection to the detector output of the usual receiver. The circuit shown in Fig. 607-B is popularly used in amateur receivers. An audio-frequency volume level control is advisable. This volume control is a variable voltage divider resistor or potentiometer connected across the secondary of the input transformer so that the audio voltage applied to the grid-cathode circuit of the tube can be varied from maximum to zero.

## Fixed Condensers and Resistors

● In addition to the principal receiver circuit elements — coils, variable condensers, gain- or volume-control resistors, tubes, etc. — there are also certain fixed condensers and resistors that are important. In both audio- and radio-frequency circuits there will be found fixed condensers connected across resistors, from plate to filament and even across portions of the circuit that appear in the diagram to be directly connected. These are *by-pass* condensers, provided to give a direct path for audio- or

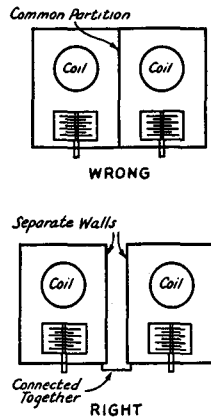

FIG. 606 — SHIELDING COMPLETE ABOUT EACH GROUP OF APPARATUS

*Do not attempt to use a common partition between enclosed stages, especially when one of them contains a regenerative detector or oscillating circuit.*

# Receiver Circuit Design

radio-frequency currents and to prevent these currents from flowing through other paths where they might cause undesirable degenerative or regenerative effects. In other cases fixed condensers are used to serve as paths for audio- or radio-frequency currents while preventing the flow of direct current, in which case they are known as *coupling* or *blocking* condensers. Since the reactance of a condenser is inversely proportional to its capacity and to the frequency, radio-frequency coupling and by-pass condensers are of small capacity while those for audio frequencies are of relatively large capacity. Small mica or non-inductive paper-dielectric condensers of from 100  $\mu\text{fd.}$  to 0.01  $\mu\text{fd.}$  capacity are commonly used for r.f. circuits, while capacities of from 0.01 to several  $\mu\text{fd.}$  are used in a.f. circuits. The particular size used, while not especially critical as to value, will be determined by the impedance across which the condenser is connected, being smaller in capacity as the parallel impedance is greater. In the case of r.f. by-passes in circuits intended to transmit audio frequencies, as in the plate circuit of a detector, the capacity must be kept small enough so that the condenser will not by-pass audio frequencies also. Typical values are 0.001  $\mu\text{fd.}$  and smaller. Audio-frequency by-pass condensers, on the other hand, usually have values ranging from  $\frac{1}{4}$   $\mu\text{fd.}$  for paper condensers to 8 or 10  $\mu\text{fd.}$  for electrolytic types. *The electrolytics should be used only as by-passes in circuits carrying audio frequency superimposed on d.c., as in cathode circuits.*

A fair value for most audio applications in amateur receivers is 1  $\mu\text{fd.}$ , although larger values may be used where better response to lower audio frequencies is desired.

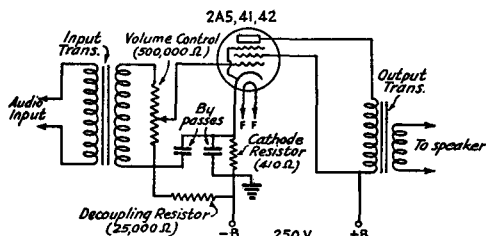
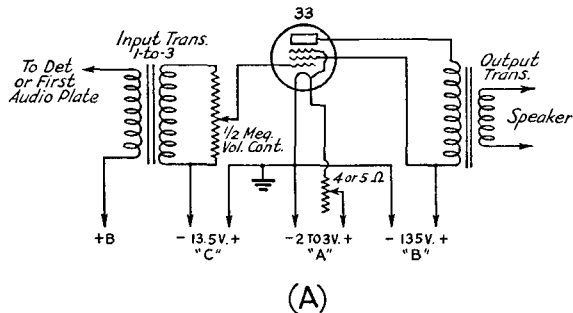
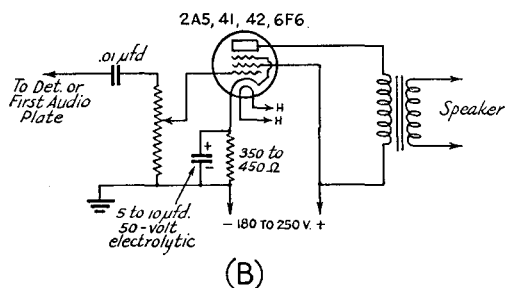

FIG. 608 — GRID-BIAS DECOUPLING CIRCUIT IN A PENTODE AUDIO STAGE



(A)



(B)

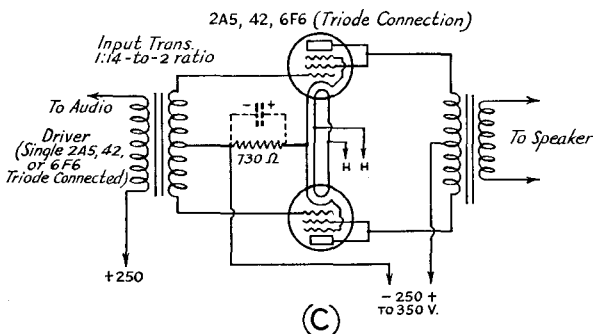

(C)

FIG. 607 — AUDIO OUTPUT AMPLIFIER CIRCUITS

(A) Pentode stage for battery-operated sets, 0.7 watt maximum output.

(B) Pentode amplifier for a.c. operated sets, 3-watt maximum output.

(C) Push-pull output circuit using triode-connected pentodes, 15-watt maximum output.

Fixed resistors are also used, in a wide variety of sizes, to provide bias voltage, to drop plate voltage, to serve as coupling loads in audio circuits and to decouple in both radio- and audio-frequency grid- and plate-return circuits. Values for resistors to provide bias voltages and to drop plate voltages depend on the current flowing through them and are determined from Ohm's law, as shown previously. Plate- and grid-coupling condenser and re-

sistor values depend primarily on the tube combination with which they are used, values shown in circuits described in this chapter being typical. Decoupling resistor and condenser combinations, used principally in grid return circuits, are connected as shown in Fig. 608. They are not critical as to value, 25,000 ohms or higher being satisfactory for the resistor and the usual by-pass capacity serving for the condenser in most instances. Usually such circuits are necessary only in high-gain amplifiers of two or more stages.

## Superheterodyne Receivers

● As has been mentioned previously, the superhet-type receiver differs from the simpler regenerative autodyne types in that the incoming signal frequency is first converted to a fixed intermediate radio frequency (usually of from 450 to 500 kc. in high-frequency superhets) and is then amplified at the intermediate frequency prior to audio-frequency detection. Tracing the operation through the circuit, following r.f. amplification the frequency con-

version is accomplished by a heterodyne process; that is, the incoming signal and the output of the h.f. heterodyne oscillator are simultaneously detected in the mixer (first detector) whose output circuit is tuned to the intermediate frequency. The output product selected is the beat between the incoming signal and local oscillator voltages and is therefore of a frequency equal to the difference between the signal and oscillator frequencies. Whatever modulation (speech or code keying) there may be on the incoming signal wave is identically reproduced in the i.f. beat output of the first detector. Consequently, the i.f. circuits and second detector behave with respect to the i.f. signal exactly as a conventional tuned r.f. amplifier and detector circuit receiving a signal of the frequency to which the circuits are tuned. For c.w. telegraph reception, an i.f. heterodyne oscillator is used to beat with the i.f. signal, as described in Chapter Four. This may be supplemented by audio-tone modulation of an i.f. stage, as shown in a later section of this chapter. The second detector output is then amplified in the audio stages.

### Input Circuits for Best Image and Noise Ratio

● A peculiarity of heterodyne action is that one of the two voltages which are combined may be either higher or lower than the other (by the proper frequency difference) and still give the same beat-frequency product. In the superheterodyne converter with the oscillator tuning intermediate-frequency higher than the signal circuit, there is possibility of first detector i.f. output from a signal intermediate-frequency *higher* than the oscillator frequency, as well as from the desired signal which is intermediate-frequency *lower* than the oscillator frequency. This will occur if there is insufficient selectivity ahead of the first detector to prevent signals twice intermediate-frequency removed from the desired signal from reaching the mixing circuit. Such undesired signals are referred to as *images*, and the relative ability of a receiver to discriminate against them is described as its *image ratio*; that is, the ratio of image-frequency signal voltage input to desired-frequency signal voltage required to give the same receiver output.

Using the conventional 456- or 465-kc. intermediates, image ratios of several hundred are obtainable at the lower amateur frequencies with but one non-regenerative input circuit; but to maintain such ratios above 7000 kc., and especially above 14 mc., considerably greater input selectivity is required. Two

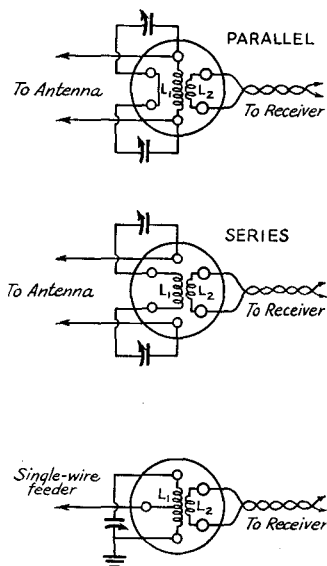

FIG. 609—TUNED ANTENNA COUPLING CIRCUITS TO REDUCE IMAGE RESPONSE AND IMPROVE SIGNAL-NOISE RATIO

Connections to standard 5- and 6-prong coil forms are indicated. In general, inductances must be adjusted by experiment for optimum results. In the parallel-tuned circuits,  $L_1$  should be of sufficient inductance to resonate on the desired band in conjunction with  $C_1$  (100  $\mu$ fd.). With series tuning, the number of turns required on  $L_1$  probably will be small.  $L_2$ , the link coupling coil, should have from two to five turns, depending upon the band and the input circuit of the particular receiver used.



## Receiver Circuit Design

tuned circuits (one r.f. stage preceding the detector input circuit) will give image voltage ratios ranging from over 10,000 at 1.75 mc., through approximately 1500 at 3.5 kc. and 150 at 7 mc., to only 50 at 14 mc.

One simple method of improving the image ratio is to tune the antenna circuit, as shown in

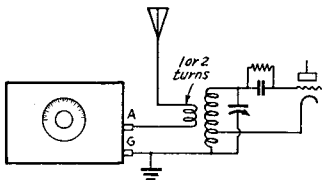

FIG. 610 — A SEPARATE REGENERATIVE CIRCUIT IMPROVES THE INPUT SELECTIVITY

No constructional changes in either superhet or regenerative detector are required.

Fig. 609. The apparent ratios can be made higher by introducing regeneration in the pre-selecting circuits, which has the effect of raising the circuit gain at resonance for the desired signal. One simple way to introduce this "negative resistance" effect is to connect a separate regenerative circuit in parallel with the superhet's input circuit, as shown in Fig. 610, connecting the antenna terminal of a simple regenerative detector to the antenna terminal of the superhet. The regenerative circuit is tuned to the same frequency and operated just below the point of oscillation. Alternatively, the r.f. or first-detector circuit of the superhet can be of the regenerative type, using one of the feed-back arrangements shown for simple regenerative detectors, as in the "High-Performance" superhet described in the next chapter. Regeneration tends to make the gain non-uniform over wide frequency ranges, however, and demands frequent readjustment with tuning. Commercial practice is to avoid regeneration and depend on additional tuned circuits for image suppression, two r.f. stages being used in several types.

A simple and inexpensive method of suppressing images that is fairly effective and entirely practical is a wavetrap placed in the antenna circuit and tuned to the image, introducing high impedance right at the unwanted (image) frequency. It is easy to install, as shown in Fig. 611-A and -B. For the usual i.f. of approximately 500 kc. the images are about 1000 kc. higher than the desired-signal frequency. Thus a trap circuit resonating 1000 kc. above the signal frequency can be used, introducing only low values of impedance at the amateur-band frequency. Such a trap is broad enough so that it seldom requires ad-

justment if once set at the center of the frequency range it is desired to eliminate. It can be tuned easily for maximum suppression of any particular frequency, however. It produces an improvement of at least several times in the signal-to-image ratio.

Capacitive coupling resulting from the stray capacitance of antenna and tuned-circuit coils also aggravates image response. This can be reduced by use of an electrostatic screen between the two coils, as shown in Fig. 611-C. This arrangement also provides a balanced termination for the two-wire type transmission line now generally used with high-frequency receivers. The screening can be made up by space-winding No. 24 d.c.c. wire on a cylinder of celluloid temporarily supported on a 3-inch diameter form, and then treating the winding with liquid Victron, Q-

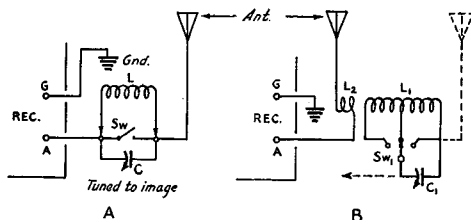

FIG. 611 — CIRCUITS FOR TWO TYPES OF WAVE-TRAP IMAGE REJECTORS

Type A is fitted with plug-in coils and is intended for use external to the receiver. The coils,  $L$ , are wound on  $1\frac{1}{2}$ -inch diameter plug-in forms, 30 turns for the 3.5-mc. range, 14 turns for 7-mc., 7 turns for 14-mc. The tuning condenser  $C$  is a 140- or 150- $\mu$ fd. midget,  $SW$  is a single-pole single-throw shorting switch.

Type B is more adaptable to mounting within the receiver, coupled inductively to the antenna lead as shown or directly in series with the lead. It should be shielded from the receiver input. For rejection of images in the 7- and 14-mc. ranges, where image trouble is likely to be most pronounced, the coil  $L_1$  should have 14 turns on a  $1\frac{1}{2}$ -inch diameter form, with a tap at the sixth turn from the "set" end. A single-section three-position tap-switch  $SW_1$  selects all or part of the coil, or shorts the trap.  $C_1$  is a 150- $\mu$ fd. midget condenser.

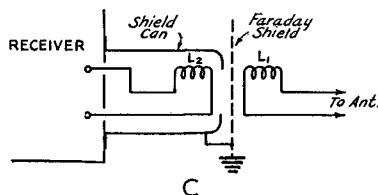

FIG. 611-C — A SUGGESTED ARRANGEMENT FOR BALANCED INPUT COUPLING WITH A FARADAY SHIELD TO MINIMIZE CAPACITY EFFECTS

$L_1$  and  $L_2$  each may be 4 turns or so on a tube-base form. The coil sizes and degree of coupling are not especially critical, one combination being satisfactory for all bands.

Max or other dielectric "dope." When the winding is thoroughly dry the form is removed and the cylinder cut length-wise to form a rectangle. The wire ends along one edge are soldered together to a wire for the ground connection, the ends at the other edge being left

higher, and falls off at the higher frequencies. The tendency, therefore, is for tube noise to predominate over thermal agitation noise in our high-frequency receivers.

A tremendous improvement in the signal-noise ratio also can be obtained by use of a directional receiving antenna system such as the rhombic and other types described in Chapter Sixteen. With such systems improvements of 10 db and greater can be accomplished, making weak signals which are undiscernible on an ordinary antenna completely intelligible.

### Frequency Converter Circuits

● The frequency converter is the heart of the superhet receiver and on its operation depends largely the performance of the whole set. Since the intermediate-frequency value adopted for short-wave supers represents a considerable difference between the signal and local oscillator frequencies, it is not feasible to use a simple autodyne detector having one tuned circuit as in the autodyne regenerative receivers used for beat-note c.w. reception. Separate circuits must be used, that of the first detector input being tuned to the signal frequency and that of the oscillator being tuned higher or lower by an amount equal to the intermediate frequency. Because of circuit convenience and other factors, it is general practice to have the oscillator tuning intermediate frequency higher than the first detector input circuit.

With the two tuned circuits, oscillator and first detector, two separate tubes may be used; or there may be a single tube designed to provide separate sets of elements for oscillator and detector circuits. Arrangements of both types are shown in Figs. 612, 613, 614, 615 and 616. These figures show standard types of oscillator-detector arrangements. In the grid injection system of Fig. 612, the signal input circuit  $L_1C_1$  is tuned to the incoming signal and the oscillator circuit  $L_2C_2$  is tuned intermediate-frequency higher. The oscillator is of the electron-coupled type, its output being coupled to the control grid of the first detector through a small capacitance. The 100,000-ohm plate load resistor of the oscillator may be replaced by a high-frequency r.f. choke in some instances, the operation being equivalent. The essential feature of this arrangement is that both the signal and oscillator voltages are impressed on the same grid. The conversion gain (ratio of i.f. voltage output to signal voltage input) and input selectivity are generally good, so long as the sum of the two voltages impressed on the grid does not exceed the grid bias

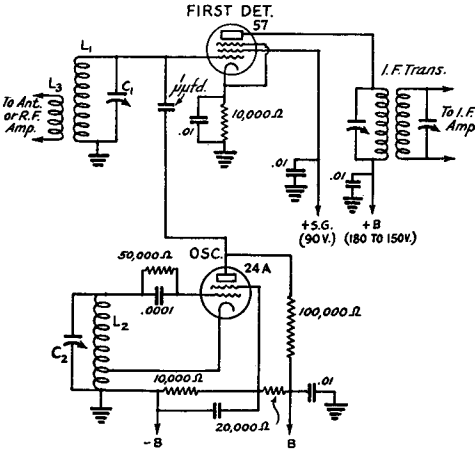

FIG. 612—SUPERHET CONVERTER CIRCUIT USING AN ELECTRON-COUPLED OSCILLATOR AND CONTROL-GRID INJECTION

separated. Such screening is also effective in preventing some noise pick-up at the receiver's input circuit.

A tuned antenna circuit or radio-frequency amplifier not only improves the image ratio, but is also effective in improving the signal-to-noise ratio of the receiver. Some compromise is necessary in reconciling the two considerations of image suppression and sensitivity, however. Image suppression will generally be better as the coupling between antenna and input circuit is looser, while signal-to-noise ratio will be better with closer coupling. The ultimate limit on sensitivity is the noise originating in the first circuit of the receiver, as was pointed out earlier in this chapter. It is therefore important to make the signal voltage in the first tuned circuit as large as possible, to compete with the thermal agitation voltage; and to obtain the best amplification possible in the first stage, to make the signal voltage as large as possible in comparison with the tube-noise voltages in the plate circuit of the first stage. A radio-frequency amplifier has more effective gain than a first detector, as a general rule, which makes the r.f. pre-selector stage advantageous in overcoming tube noise. Thermal agitation noise is greater at the lower frequencies, where the tuned-circuit impedance is

# Receiver Circuit Design

and run the grid positive. Since the i.f. voltage produced is the product of the signal and oscillator voltages, it is desirable to make the oscillator voltage as high as possible without exceeding this limitation. In practice, with the circuits tuning over a number of bands and therefore likely to give wide fluctuations in oscillator output, oscillator r.f. voltage is made considerably less than the maximum limit.

The circuits of Fig. 613 are considerably less critical in this respect, since the signal and oscillator voltages are applied to separate grids. The circuit at 613-A uses a combined detector-oscillator tube having internal electron coupling between the two sets of elements, such a tube being known as a pentagrid converter. Quite high conversion efficiency can be obtained as well as good input selectivity. The tube is not a particularly desirable one for high-frequency work when used in this way, however, because the output of the oscillator drops off as the frequency is raised and because the two sections of the tube are not well enough isolated to prevent space-charge coupling and "pulling," or the tendency of the detector tuning to affect the oscillator frequency. An arrangement which overcomes these defects to a considerable extent is shown at Fig. 613-B. In this circuit the oscillator grid (No. 1) of the pentagrid converter is used as the mixing element, but is fed from a separate oscillator. The better performance of the 56 or 76 tubes as contrasted with the oscillator section of the 2A7 or 6A7 at high frequencies results in more uniform output over the high-frequency range. In the circuits of Fig. 613 the oscillator voltage is not critical, so long as enough is supplied, and the grid-current limitation of the circuit of Fig. 612 is absent.

A third type of first-detector-oscillator coupling is given in Fig. 614. In these diagrams the suppressor grid of a pentode-type detector is used as the means for introducing the oscillator voltage into the detector circuit to beat with the incoming signal. Suppressor-grid coupling offers the same advantages as the circuit of Fig. 613-B, but usually will require a greater oscillator voltage because of the lesser control factor of the suppressor grid as compared to the inner grid of a pentagrid converter tube. The oscillator voltage is not critical, however, and does not affect the input selectivity of the detector. Since the suppressor must be maintained at an average voltage considerably negative with respect to the cathode, the plate impedance of the first detector is reduced. This tends to lower the

gain out of the first detector, compared to the gain the same tube would give with its suppressor maintained at cathode potential as is usual in amplifier applications. The suppressor must have negative bias, it should be emphasized, since otherwise the oscillator would be ineffectual in modulating the first-detector space current.

A circuit which utilizes screen-grid injection in the first detector, with a separate oscillator, is shown in Fig. 615. This arrangement requires somewhat more power from the oscillator, since the screen-grid circuit of the detector has a relatively low resistance compared to the grids used in other methods. The oscillator voltage swing required is also considerable for strict screen-grid modulation. However, it permits the use of a pentode type first detector and operates with a higher plate impedance than a pentode with suppressor injection. The latter feature tends to keep up the gain at intermediate frequency, where a high-impedance transformer circuit is the

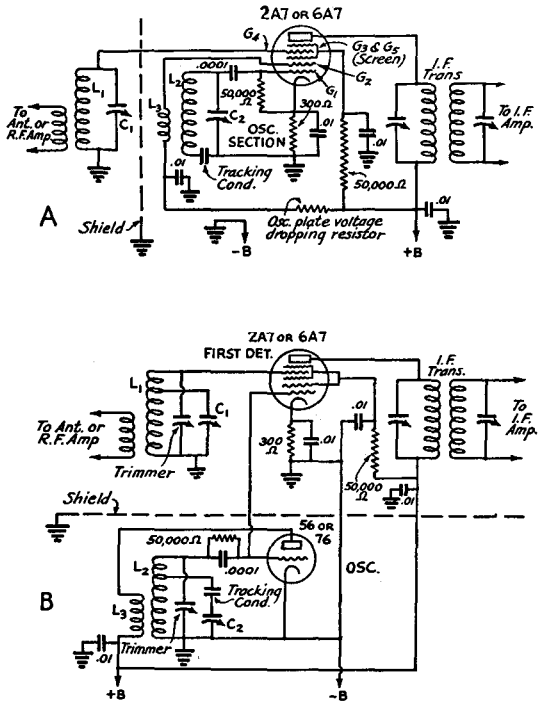

FIG. 613 — THESE FREQUENCY-CONVERTER CIRCUITS ARE FOR USE WITH PENTAGRIDS

The circuit at A shows how the tube is used as a combined detector-oscillator. A better arrangement for high-frequency work, making use of a separate oscillator with the pentagrid tube as detector or "mixer," is shown at B.

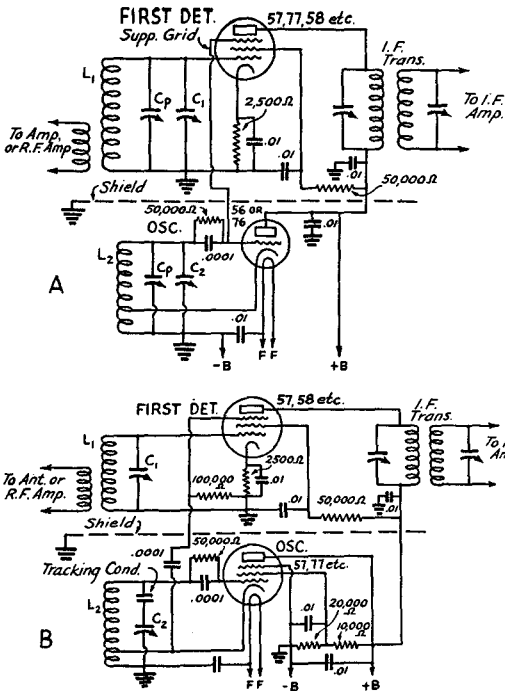

FIG. 614 - CONVERTER CIRCUITS EMPLOYING SUPPRESSOR-GRID INJECTION

detector load. Also, at increasingly higher frequencies the capacitance between the screen and control grid automatically gives auxiliary control-grid injection, for which reason this circuit is preferred by some designers. Proper proportioning of the oscillator circuit and coupling to the detector screen provide uniform voltage injection over wide frequency ranges with this system, although considerable care in circuit design is advisable.

Circuits using the 6L7 mixer tube as the first

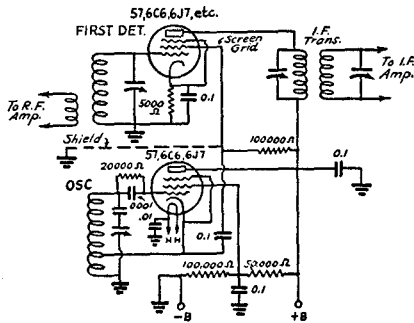

FIG. 615 - CONVERTER CIRCUIT FOR SCREEN-GRID INJECTION

detector are shown in Fig. 616. This metal type has features which correct to some extent the several minor deficiencies encountered in conversion circuits of the other types. The space-charge coupling between detector input and oscillator circuits which characterizes the -A7 and -A8 pentagrids is largely eliminated, while the lowering of plate impedance which is characteristic of suppressor injection in a pentode is absent, since the oscillator grid (No. 3) is completely screened and is backed up by a separate suppressor grid. At the lower amateur frequencies, a smaller oscillator voltage is required for complete modulation than with suppressor injection, while the power demand is negligible as compared to screen-grid injection. At frequencies above 28 mc., the separate-oscillator arrangements of Figs. 612, 613 and 615 have been found to give somewhat greater conversion gain, however. The value of oscillator voltage can vary over a considerable range without affect-

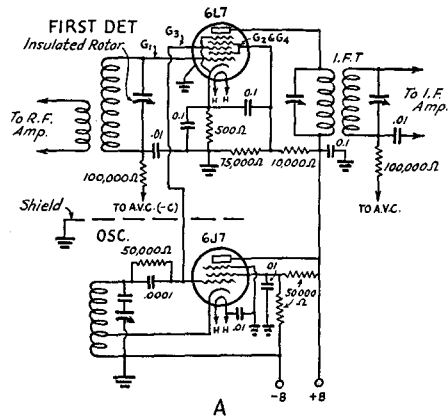

FIG. 616 - CONVERTER CIRCUITS FOR THE 6L7 TUBE

# Receiver Circuit Design

ing the conversion gain, which tolerance is advantageous in multi-band tuning systems. Either the circuit coupling method of Fig. 616-A or that of 616-B may be used. The latter is usually more adaptable with band-switch tuning systems using standard units, since the additional tube capacitance of the mixer can be made less effective in raising the minimum capacitance of the oscillator circuit. In the first circuit the No. 3 oscillator grid of the mixer is automatically biased by the voltage developed across the oscillator's grid leak, while in the second circuit the No. 3 grid is biased by the rectified voltage developed across its own leak, the bias being proportional to the oscillator voltage in both cases.

## Oscillator Stability and Tracking

● In addition to the "pulling" effects previously emphasized, inherent stability in the high-frequency oscillator of the converter is highly important in amateur-band receivers, especially in high-selectivity single-signal types. Variations in oscillator frequency with changes in supply voltage, as may occur when gain adjustment varies the plate voltage because of power supply regulation, are of particular importance. It is for this reason that electron-coupled oscillator circuits, and other types using screen-grid tubes, are generally used. A screen-grid type oscillator has an inherent tendency to maintain constant frequency with changes in supply voltage because of the compensating action when both plate and screen voltages are changed in the same direction. Special arrangements with triode oscillators can be made to give similar results; for instance, the oscillator plate voltage can be taken from a voltage divider in which neon tubes are used to maintain a nearly constant drop.

In all these circuits it is essential that the oscillator be completely shielded from the detector. Coupling other than by the means intended, especially between the tuned circuits, will result in "pulling" and will render accurate tuning difficult. Several types of oscillator circuits are shown for purposes of illustration; in many cases one oscillator circuit can be substituted for another without affecting the functioning of the detector or mixing circuit, since the two are generally entirely separate except for the coupling by which the oscillator voltage is introduced into the detector circuit.

Where ganged tuning control of oscillator and signal-input circuits is used, it is necessary to maintain a constant frequency difference throughout the tuning range, this difference

being equal to the intermediate frequency. For the narrow ranges of the amateur bands, particularly above 7 mc., this can be ac-

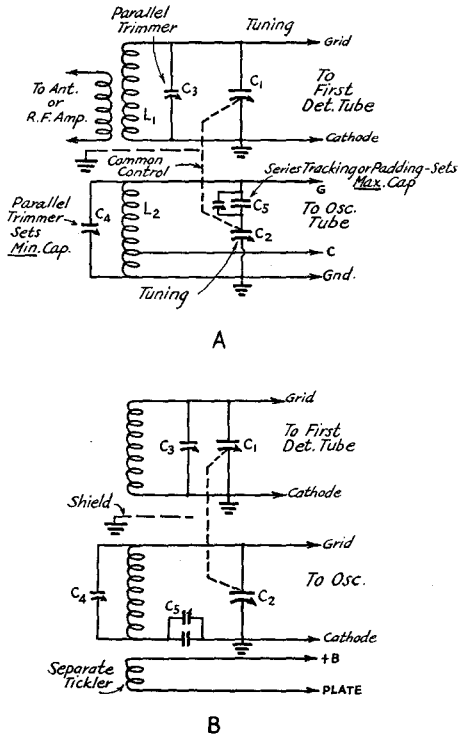

FIG. 617 — CONVERTER CIRCUIT TRACKING METHODS

Approximate circuit values for 450- to 465-kc. intermediates with tuning ranges of approximately 2.15-to-1,  $C_1$  and  $C_2$  having a maximum of 140  $\mu\text{fd.}$  and the total minimum capacitance, including  $C_3$  or  $C_4$ , being 30 to 35  $\mu\text{fd.}$

Tuning Range	$L_1$	$L_2$	$C_5$
1.7-4 mc.	50 $\mu\text{h.}$	40 $\mu\text{h.}$	0.0013 $\mu\text{fd.}$
3.7-7.5 mc.	14 $\mu\text{h.}$	12.2 $\mu\text{h.}$	0.0022 $\mu\text{fd.}$
7-15 mc.	3.5 $\mu\text{h.}$	3 $\mu\text{h.}$	0.0045 $\mu\text{fd.}$
14-30 mc.	0.3 $\mu\text{h.}$	0.78 $\mu\text{h.}$	None used

Approximate values for 450- to 465-kc. i.f. with a 2.5-to-1 tuning range,  $C_1$  and  $C_2$  being 350  $\mu\text{fd.}$  maximum, minimum capacitance including  $C_3$  and  $C_4$  being 40 to 50  $\mu\text{fd.}$

Tuning Range	$L_1$	$L_2$	$C_5$
1.5-4 mc.	32 $\mu\text{h.}$	25 $\mu\text{h.}$	0.00115 $\mu\text{fd.}$
4-10 mc.	4.5 $\mu\text{h.}$	4 $\mu\text{h.}$	0.0028 $\mu\text{fd.}$
10-25 mc.	0.8 $\mu\text{h.}$	0.75 $\mu\text{h.}$	None used
0.5-1.5 mc.	240 $\mu\text{h.}$	130 $\mu\text{h.}$	425 $\mu\text{fd.}$

# The Radio Amateur's Handbook . . . . .

completed to a fair extent, with equal-capacitance condensers in the several tuning circuits, by simply making the oscillator inductance sufficiently smaller than the signal-frequency

tracking capacitance becomes larger as the ratio of the oscillator to signal frequency becomes nearer to unity (that is, as the tuning frequency becomes higher). Typical circuit values are given in the accompanying table.

## Intermediate-Frequency Amplifiers

● The intermediate-frequency amplifier (i.f. amplifier) of a superhet is, as mentioned, simply a tuned radio-frequency amplifier designed to work at a fixed frequency, generally in the region of 450 to 500 kc. for short-wave superhets. The tuned circuits of i.f. amplifiers usually are built up as transformers, consisting of a shielding container in which the coils and condensers are mounted. The coils are of the universal-wound or honey-comb type and are very small in size so that the magnetic field will be restricted. Both air-core and powdered-iron core coils are used, the latter having somewhat higher Q's and, hence, greater selectivity and gain per unit.

Tuning condensers are of the midget type and may have either mica or air dielectric, air-dielectric condensers being preferable for short-wave superhets because their capacity is practically unaffected by changes in temperature. Such stability is of great importance in highly selective i.f. amplifiers or single-signal superhets equipped with quartz crystal filters because a slight change in tuning capacity can greatly impair the performance of the receiver.

Intermediate frequency amplifiers usually consist of one or two stages. With modern tubes and transformers, two stages will give all the gain usable, considering the noise level, so that additional stages would have no particular advantage. If regeneration is introduced into the i.f. amplifier — as is described later — a single stage will give enough gain for all practical purposes.

Typical circuit arrangements for three types of transformers are shown in Fig. 618. Alternative methods of gain-control biasing, by-passing and decoupling are indicated. The method of returning all by-passes to the cath-

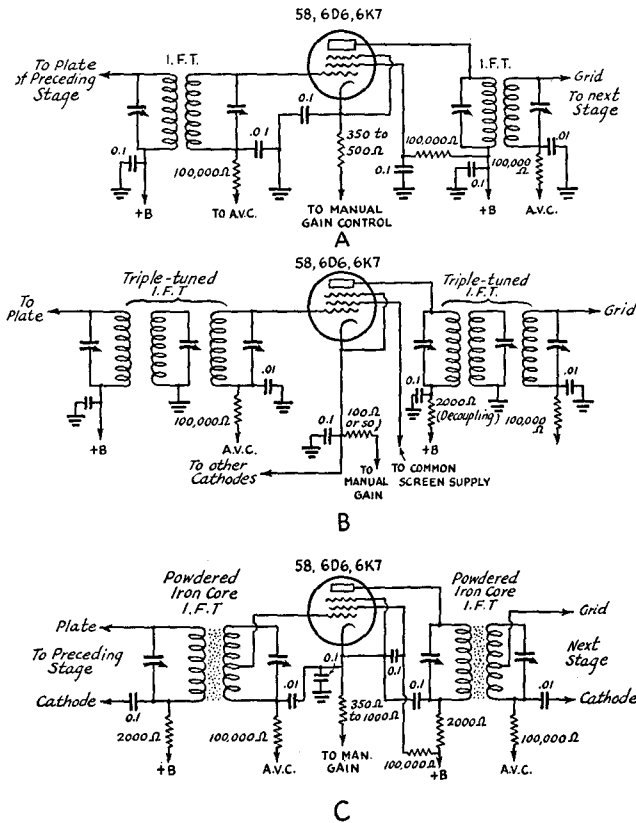

FIG. 618—I.F. AMPLIFIER CIRCUITS FOR THREE TYPES OF TRANSFORMERS. A, DOUBLE TUNED; B, TRIPLE-TUNED; C, HIGH-GAIN IRON CORE

circuit inductance. For more precise tracking over the tuning ranges, especially at the lower frequencies, a tracking capacitance in series with the oscillator tuning condenser is used to maintain this difference more uniformly. Two typical arrangements are shown in Fig. 617. As indicated on the diagrams, the tracking capacitance  $C_5$  commonly consists of two condensers in parallel, a fixed one of somewhat less capacitance than the value needed and a smaller variable in parallel to allow for adjustment to the exact proper value. In practice, the trimmer capacitance  $C_4$  is first set for the high-frequency end of the tuning range and then the tracking capacitance is set for the low-frequency end of the tuning range. The

# Receiver Circuit Design

ode shown in *C* is recommended in high-gain circuits using iron-core transformer units. Where two such stages are used there will be a tendency to instability and oscillation because of the high gain, and careful circuit arrangement is necessary. It is also advisable to use

progressively increased (the selectivity is reduced) while the mid-frequency remains the same, 465 kc. The band-width at 10 times down, for a single transformer, is approximately 15 kc. for position No. 1, 30 kc. for No. 2 and 45 kc. for position No. 3. Such variable-selectivity transformers do not, of course, provide higher than ordinary selectivity, but permit increasing the i.f. band width for high-fidelity reception or for reception of relatively unstable signals on the ultra-high frequencies.

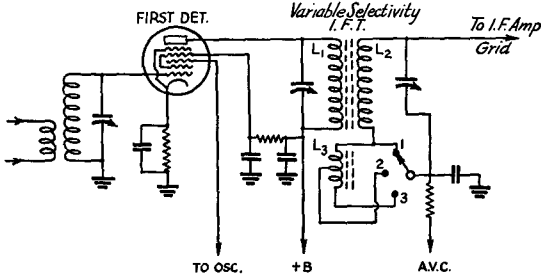

FIG. 619 — CIRCUIT OF I.F. TRANSFORMER WITH VARIABLE SELECTIVITY OBTAINED BY ELECTRICAL VARIATION OF MUTUAL COUPLING AND SECONDARY INDUCTANCE

tapped transformers in such cases, thereby reducing the gain per stage but obtaining the increased selectivity which is possible.

### Variable-Selectivity Transformers

Transformers giving variable selectivity are being used to considerable extent in current receivers. One method of accomplishing this is by variable coupling between the coils of the transformers, employing mechanical adjustment. One such type is the Hammarlund air-core model with multi-section primary and secondary windings. The coupling is usually adjusted over a range from slight over-coupling to relatively loose coupling, giving a selectivity curve that varies from double-humped to very sharp. The band-width variation obtainable is approximately 7-to-1.

Another method of accomplishing variable i.f. selectivity with transformer coupling is illustrated by the circuit of Fig. 619. This method is electrical rather than mechanical, the variation being accomplished in three steps by means of a switch. The special transformer (Aladdin H-103) is of the powdered-iron core type and has an auxiliary winding  $L_3$  in addition to the usual tuned primary and secondary  $L_1$  and  $L_2$ . This winding is coupled to the primary. With the switch in No. 1 position, the extra winding is cut out. In No. 2 position a part of the auxiliary winding is connected in series with the secondary, and in No. 3 position the whole of the extra winding is connected in series with the secondary. Thus the mutual coupling and secondary inductance are simultaneously altered so that the band-width is

### Single-Signal Selectivity

● In ordinary beat-note reception, with either a regenerative autodyne or the usual superhet receiver, identically the same beat note can be obtained with a signal beat-frequency above the local oscillator frequency as with another beat-frequency below the local oscillator frequency. For instance, if the beat note on a desired signal is 1000 cycles (with the oscillator 1 kc. lower than the signal frequency), another signal 2 kc. lower than the desired signal will also give a 1000-cycle beat note and interfere as if it were on the same frequency as the desired signal. As shown by Fig. 620, this audio-image interference is eliminated in the single-signal superhet. This type of receiver resembles the conventional superheterodyne of ordinary selectivity, but has in addition to the conventional tuned i.f. circuits a first intermedi-

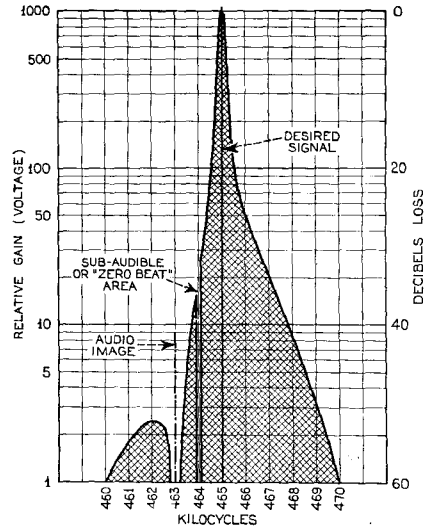

FIG. 620 — A GRAPHICAL ILLUSTRATION OF SINGLE-SIGNAL SELECTIVITY. THE SHADED AREA INDICATES THE REGION IN WHICH RESPONSE IS OBTAINABLE

ate circuit in which extremely high selectivity is obtained either by means of a piezo-electric filter (quartz crystal) or by regeneration.

Because of the high selectivity, the signal voltage reaching the second detector drops to a negligible value a few hundred cycles off resonance, especially when the filter circuit is of the quartz crystal type which can be adjusted to reject particularly at one frequency. Hence, with the beat oscillator coupled to the second detector practically only one beat-note response will occur, and this will be for the signal tuned in on the resonance peak of the i.f. circuit. When a receiver of this type is tuned across a signal, it will be heard on only one side of zero beat, instead of on both sides as with receivers of ordinary selectivity. The extreme selectivity also reduces noise and other types of interference, of course. The single-signal superhet may be provided with a means for varying the selectivity so that the receiver will be suitable for the reception of voice as well as c.w. telegraph signals, since a wider band must be passed for faithful reproduction of voice modulation.

## Quartz Crystal Filters

● The quartz crystal filters used in the i.f. amplifiers of Single-Signal type receivers are of two distinct types. One type permits adjustment of the sharpness of crystal resonance (selectivity) from the maximum usable for c.w. telegraph reception to a minimum which permits reception of telephone signals with fair intelligibility, while the other type has a practically fixed sharpness of resonance. Typical circuits of both types of filters are shown in Fig. 621, A and B being variable band-width circuits while C is a fixed selectivity circuit. In each of the three arrangements shown, the crystal, which is connected in one arm of a bridge circuit, is especially ground to have a series-resonant frequency corresponding to the receiver's intermediate frequency and to have negligible response as a resonator at other frequencies in this vicinity, good grade commercial filter crystals for intermediate frequencies between 450 and 500 kc. being so dimensioned and ground as to have no subsidiary responses within 7 kc. or so of the main response peak. To insure active response, the crystal is usually mounted in a holder having an air gap of approximately 0.001 inch between the crystal and one plate.

The crystal serves as the selective series coupling element between the input transformer  $T_1$  and the output transformer  $T_2$ . Since the crystal has a series-resonant impedance of the order of 2500 to 3000 ohms, a step-up is provided in the output transformer to give an efficient match between the crystal network and the high-impedance (100,000-ohm or so) tuned grid circuit of the following amplifier. This is obtained either by the auto transformer connection of  $T_2$  in A, or by the separate primary  $L_4$  in B and C. In A the tuned output winding is tapped at approximately  $\frac{1}{4}$  to  $\frac{1}{6}$  the total turns from the ground end, while in B and C the primary  $L_4$  has  $\frac{1}{4}$  to  $\frac{1}{6}$  the inductance of  $L_3$  and is coupled as closely as possible to the latter. For 450 to 465 kc. intermediates,  $L_3$  is of approximately 1.2-millihenry inductance, as is also the secondary of the input transformer,  $L_2$ , in A and B. In C, input primary  $L_1$  is approximately 1.2 mh. and  $C_1$  is a 100- $\mu$ fd. variable, while the center-tapped input secondary  $L_2$  is of approximately  $\frac{1}{3}$  the primary inductance, to give an impedance step-down from the tuned primary  $L_1$ , and is coupled closely to the latter. In A and B, the untuned secondary  $L_3$  is of approximately 5.5-millihenry inductance and is closely coupled to  $L_2$ . In each case the output coupling condenser  $C_3$ , which allows adjust-

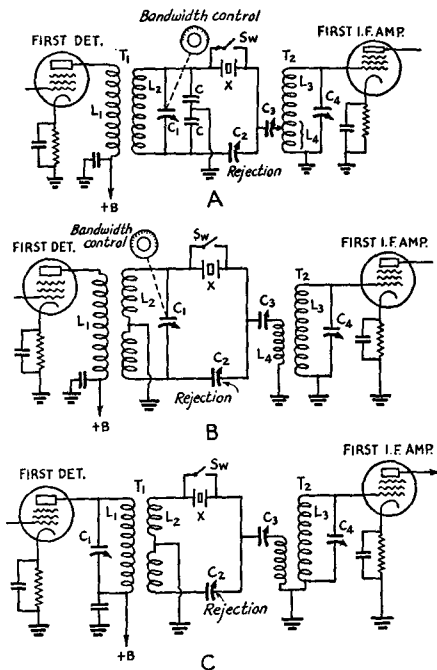

**FIG. 621 — THREE TYPES OF CRYSTAL FILTER CIRCUITS**

*Circuits A and B give variable band width, while C is a fixed sharpness of resonance circuit. All three have adjustable rejection. Circuit values for 450 to 500 kc. operation are given in the text.*



## Receiver Circuit Design

ment to compensate for crystal variations, is of approximately 50- $\mu$ fd. maximum capacitance. Since none of the coupling values in the filter circuit is especially critical, a fixed condenser of this capacitance is sometimes used at  $C_3$ . In all three circuits, the "rejection control" condenser  $C_2$  has a maximum capacitance of 10  $\mu$ fd. or so and a very low minimum. The switch,  $SW$ , is used to short out the crystal for "straight" superhet reception with ordinary selectivity. In the construction of such filters, the input and output circuits are shielded from each other, as shown by the unit described in the next chapter.

### Variable Selectivity Action

● In circuits of the type of A and B, variable selectivity is obtained by adjustment of the variable input impedance, which is effectively in series with the crystal resonator, by means of the "Band Width" control. This control varies the capacitance  $C_1$  (50- $\mu$ fd. in A and 100- $\mu$ fd. in B), which tunes the balanced secondary circuit of the filter input transformer

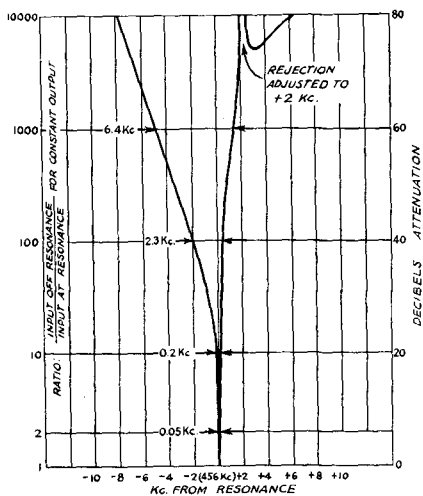

FIG. 622 — MAXIMUM CRYSTAL SELECTIVITY CURVE FOR THE FILTER CIRCUIT OF FIG. 621-A

$T_1$ . In A this balance is obtained by a capacitance center tap (between the 100- $\mu$ fd. fixed condensers  $C$  and  $C$ ), while in B the secondary winding of the transformer is center-tapped. When the secondary is tuned to i.f. resonance, which is also the series-resonant frequency of the crystal, the parallel impedance of the  $L_2$ - $C_1$  combination is maximum and is purely resistive, as was shown in the discussion of parallel-circuit impedance in Chapter Four. Since the secondary circuit is center-tapped,

one-fourth of this resistive impedance (approximately 25,000 ohms) is in series with the crystal, through  $C_3$  and  $L_4$ . This effective resistance lowers the  $Q$  of the crystal circuit from a maximum of about 10,000 to approxi-

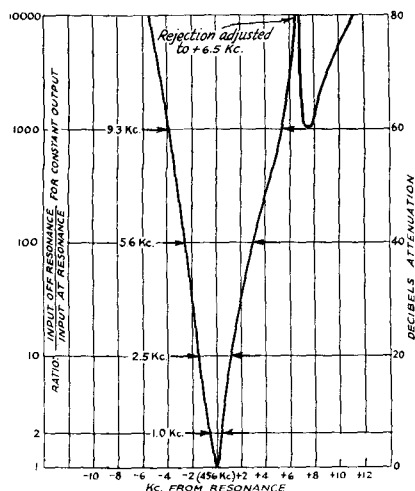

FIG. 623 — MINIMUM CRYSTAL SELECTIVITY CURVE FOR THE CIRCUIT OF FIG. 621-A

mately 500 and accordingly makes its selectivity minimum. At the same time, the voltage applied to the crystal circuit (across the tapped portion of the input secondary) is maximum. The large untuned primary induces practically constant current in the tuned secondary.

When the input circuit is detuned from the crystal resonant frequency, the resistance component of the input impedance decreases, and so does the total parallel impedance. Accordingly, the selectivity of the crystal circuit becomes higher and the applied voltage falls off. At first the resistance decreases faster than the applied voltage, however, because the reactance component of impedance begins to rise immediately off resonance, as shown by Fig. 404 of Chapter Four. The result is that at first the c.w. output from the filter *increases* as the selectivity is increased, output reaching a maximum near the point where the reactance and resistance components of the input impedance are equal. The output then falls off gradually as the input circuit is detuned farther from resonance and the selectivity becomes still higher. The net result of this behavior is that the filter output for a pure c.w. signal is least when the band width is the greatest (input tuned to resonance), then increases to maximum at medium selectivity, and finally falls off slightly at maximum selectivity. The

total variation is only a few decibels, however, as shown by measurements in actual receiver circuits.

The variable selectivity actually obtained in a receiver using the filter circuit of Fig. 621-A

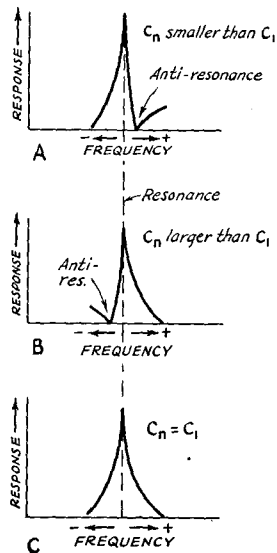
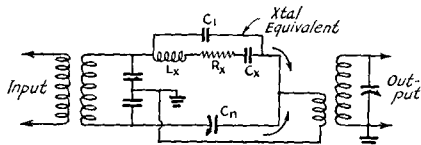

FIG. 624 — THE REJECTION ACTION OF THE S.S. CRYSTAL FILTER CIRCUIT

is shown in Figs. 622 and 623. It is notable that the band-width variation at 10 times down is over a range of more than 12 to 1 with the crystal filter, and that the maximum selectivity is more than 35 times that obtained for the same type receiver with the crystal filter switched out (see Fig. 602). A filter of this type is used in the crystal S.S. superhet described in the next chapter.

### Adjustable Rejection

● The crystal is connected in the bridge circuit so that counter voltage of controllable phase can be applied to the output side of the filter so as to modify the shape of the crystal's normal resonance curve, both to prevent unselective transmission through the capacitance of the mounting electrodes and to make the crystal anti-resonant for a particular interfering signal in a range from a few kilo-

cycles above to a few kilocycles below the series-resonant frequency. This feature is common to all three filter circuits of Fig. 621 and its action is illustrated in Fig. 624.

In the circuit diagram of the latter figure the crystal is represented in its electrical equivalent, as described in Chapter Four. The capacitive reactance of the crystal electrodes,  $C_1$ , normally resonates with the inductive reactance of the crystal series network to make this part of the circuit anti-resonant at a frequency approximately 0.5 percent above crystal resonance. By means of the phasing condenser  $C_n$  the effect of the capacitive reactance of  $C_1$  can be modified to shift the anti-resonant frequency, as shown by A and B of Fig. 624, or to make the crystal resonance curve practically symmetrical, as shown by curve C. The practical effectiveness of this rejection action is shown by the crystal selectivity curves of Figs. 622 and 623 for the filter of Fig. 621-A. Rejection of at least 60 db for interference up to within a few hundred cycles of resonance on either side can be obtained.

Rejection is practically independent of band-width control in this type of filter. The phasing condenser is sometimes used as a "selectivity" control to broaden the response in filters of the fixed band-width type (Fig. 621-C) by adjusting its capacitance above or below the rejection region. However, this only serves to by-pass the crystal circuit, in effect, and does not change the sharpness of resonance as does the band-width control of the other two circuits. Also, the phasing condenser is then ineffectual for rejection of interfering signals.

### Regenerative I.F. Amplifiers

● A regenerative i.f. amplifier stage also can be used to provide high selectivity combined with high gain in the amateur superhet. Such an amplifier operates in much the same fashion as a regenerative input amplifier or first detector in giving high selectivity. In contrast to the crystal filter, which reduces or attenuates signals off resonance frequency, the regenerative amplifier increases the signal at resonance frequency of the i.f. circuit and leaves signals of other frequencies at practically the same amplitude they would have if the amplifier were not regenerative. The circuit of an i.f. amplifier of this type is shown in Fig. 625. In addition to the usual input and output transformer windings  $L_1$  and  $L_2$ , the input transformer has a feed-back coil  $L_3$  connected in the plate return circuit between cathode and ground, through the usual by-passed cathode bias resistance  $R_1$ . This coil is connected so that r.f. current flowing back to the cathode

## Receiver Circuit Design

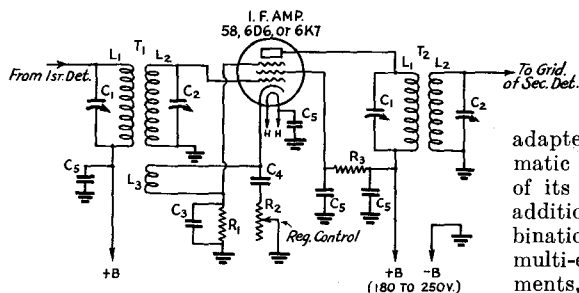

FIG. 625 — HIGH-SELECTIVITY REGENERATIVE I.F. AMPLIFIER CIRCUIT

$L_1$  and  $L_2$  — 1.2-mh. coils of 450- to 465-kc. i.f. transformer, optimum coupling.

$L_3$  — Tickler winding, approximately 20 turns coupled to  $L_2$ .

$C_1$  and  $C_2$  — 50- to 100- $\mu$ fd. i.f. tuning condensers (air type).

$C_3$  — 0.1- $\mu$ fd. tubular by-pass condenser.

$C_4$  — 0.01- $\mu$ fd. blocking condenser.

$C_5$  — 0.01 to 0.1 by-pass condensers.

$R_1$  — 350-ohm cathode resistor.

$R_2$  — 2000-ohm variable resistor (selectivity control).

$R_3$  — 100,000-ohm screen voltage dropping resistor.

induces voltage in phase with the r.f. voltage on the grid, the usual tickler arrangement. Regeneration is controlled by the 2000-ohm variable resistor  $R_2$ , which shunts the tickler coil for r.f., through the blocking condenser  $C_4$ . The latter is necessary to prevent variation of  $R_2$  from varying the d.c. grid bias. Regeneration is maximum when the resistance of  $R_2$  is all in circuit, and is minimum when  $R_2$  is zero, shorting the tickler coil.

Selectivity comparable with that obtained with a crystal filter can be obtained with a regenerative i.f. stage. However, the regenerative amplifier is not as stable and does not provide adjustable rejection. The maximum gain is very high and not more than one i.f. stage is advisable in a receiver using such an amplifier, unless provision is made to use the additional non-regenerative stage only when regeneration is not used in the high-selectivity first stage. A superhet using a regenerative i.f. amplifier is described in the next chapter.

### Second Detectors—Automatic Gain Control

● The second detector of a superhet receiver performs the same function as the detector in the simpler receiver, but usually operates with a higher input level because of the relatively great r.f. amplification which is obtained in the preceding i.f. stages. Therefore, in the second detector of the superhet the aim is to have ability to handle large signals without distur-

tion rather than to have high sensitivity in the detector itself. Grid-leak and plate detection are used to some extent, but the diode detector is by far the most popular. It is especially

adapted to furnishing automatic gain or automatic volume control (a.v.c.) as a by-product of its detector operation, which gives it an additional advantage. A wide variety of combinations will be found, including circuits using multi-element tubes which include diode elements, but all are basically the same.

With the wide range of signal levels encountered in high-frequency reception and the severe fading which is practically always prevalent, automatic regulation of the gain of the receiver in inverse proportion to the signal strength is a great advantage. This is readily accomplished in the modern type superheterodyne by using the average rectified voltage developed by the received signal across a resistance in a detector circuit to vary the bias on the r.f. and i.f. amplifier tubes. This voltage being practically proportional to the average amplitude of the detector signal, the gain is reduced as the signal strength is greater. The control will be more complete as the number of stages to which the a.g.c. bias is applied is greater. It is hardly worth while to attempt to use a.g.c. on a single r.f. or i.f. stage unless the control bias is applied to two grids of the amplifier tube, because the gain regulating action "can't keep up with the signal level," and control of at least two stages is preferable.

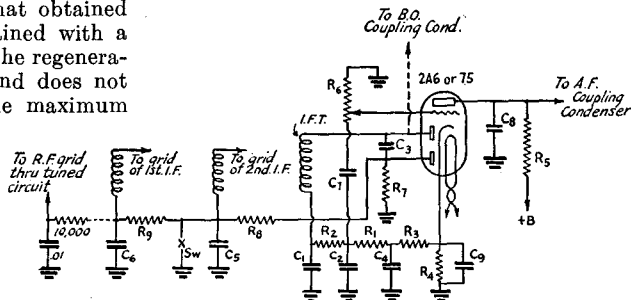

FIG. 626 — THE SECOND DETECTOR-A.G.C.-FIRST AUDIO CIRCUIT

$R_1$  — 250,000-ohm  $\frac{1}{2}$  watt.

$R_2, R_3$  — 50,000-ohm  $\frac{1}{2}$  watt.

$R_4$  — 2000-ohm  $\frac{1}{2}$  watt.

$R_5$  — 250,000-ohm  $\frac{1}{2}$  watt.

$R_6$  — Volume control, 1 to 3 megohms.

$R_7$  — 2 to 5 megohms,  $\frac{1}{2}$  watt.

$R_8$  — 1-megohm  $\frac{1}{2}$  watt.

$R_9$  — 10,000-ohm  $\frac{1}{2}$  watt.

$C_1, C_2, C_3$  — 100- $\mu$ fd. mica.

$C_4, C_5, C_6$  — 0.01- $\mu$ fd. paper, non-inductive.

$C_7$  — 0.1- $\mu$ fd. paper.

$C_8$  — 250- $\mu$ fd. mica.

$C_9$  — 5- $\mu$ fd. 25-volt electrolytic.

A typical circuit of a diode-triode type tube used as a combined a.g.c. rectifier, detector and first audio amplifier is shown in Fig. 626. One plate of the diode section of the tube is used for signal detection and the other for a.g.c. rectification. The detector diode plate is connected directly to the "high" side of the i.f. transformer secondary, while the a.g.c. diode plate is fed through the small coupling condenser  $C_3$ . The audio diode load consists of  $R_2$  and  $R_1$  in series. The load condenser is split into two sections,  $C_1$  and  $C_2$ , to aid in filtering r.f. from the lead which goes through the audio coupling condenser,  $C_7$ , to  $R_6$ , the audio volume control, thence to the grid of the triode section of the tube.  $C_4$  and  $R_3$  comprise a decoupling circuit for keeping r.f. out of the cathode resistor,  $R_4$ .  $C_9$  is the usual high-capacity by-pass across the cathode resistor.

The triode section of the 2A6 or 75 is used as an audio amplifier, resistance coupling being used on both input and output circuits.  $R_6$  is the audio volume control,  $R_5$  the plate load resistor.  $C_8$  is a mica by-pass which short-circuits any r.f. which may have escaped by the filter in the diode circuit.

The a.g.c. diode load resistor is  $R_7$ , across which is developed the negative bias resulting from the flow of rectified carrier current. This negative bias is applied to the grids of the controlled stages through the filtering resistor  $R_8$ .

It does not matter which of the two diode plates is selected for audio and which for a.g.c. The reason for separating the two is to permit the audio diode return to be made directly to the cathode and the a.g.c. diode return to ground. This method of connection places negative bias on the a.g.c. diode equal to the d.c. drop through the cathode resistor (a matter of a volt or two) and thus delays the application of a.g.c. voltage to the amplifier grids, since no rectification takes place in the a.g.c. diode circuit until the carrier amplitude is large enough to overcome the bias. Without this delay, the a.g.c. would start working even with a very small signal, which is undesirable because the full amplification of the receiver then cannot be realized on weak signals. In the audio diode circuit this fixed bias must be avoided; hence the return is made directly to the cathode.

Time constant is important in the a.g.c. circuit, and is determined by the  $RC$  values in the diode and bias-feed circuits to the controlled stages. In high-frequency reception a relatively small time constant is preferable, as compared to general practice in broadcast-band receivers. Capacitance and resistance values given here and for the superhet receivers described in the following chapter are generally satisfactory. The time constant can be estimated from total resistance effective in the a.g.c. circuit (including the rectifier load resistance and the grid-feed filtering resistors) and the total capacitance to ground (including the grid-return by-passes of the respective controlled stages). These resistance and capacitance values should be substituted in the time-constant equation given in Chapter Three. A value of a few hundredths of a second is usual.

In the circuit of Fig. 626,  $R_7$  and  $R_8$ , in combination with  $C_5$  and  $C_6$ , set the time constant of the a.g.c. circuit. Larger values of  $R_8$ ,  $C_5$  and  $C_6$  will increase the time constant so that the a.g.c. does not operate as rapidly. A large time constant is not desirable because it prevents the a.g.c. from keeping up with rapid fading. A too-small time constant would tend to "wash out" modulation. The values shown have been found to be satisfactory in operation.

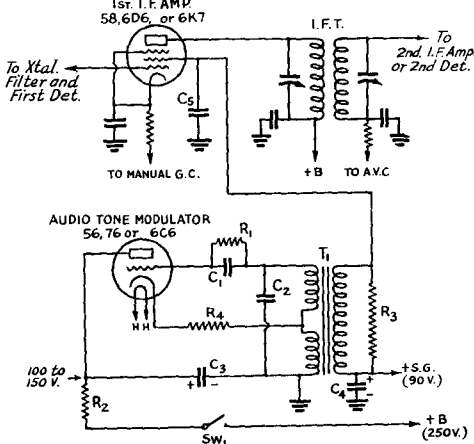

FIG. 627 — THE HETEROTONE MODULATOR CIRCUIT

- $T_1$  — Push-pull input type audio transformer.
- $C_1$  — 0.002- $\mu$ fd. fixed condenser (paper).
- $C_2$  — 500- $\mu$ fd. primary tuning condenser (various sizes should be tried until tone is between 500 and 1000 c.p.s.).
- $C_3$  — 1- to 4- $\mu$ fd. plate by-pass condenser (paper or electrolytic).
- $C_4$  — 1- to 4- $\mu$ fd. screen-supply by-pass.
- $C_5$  — 0.002- $\mu$ fd. screen-grid r.f. by-pass.
- $R_1$  — 100,000-ohm grid leak.
- $R_2$  — 100,000-ohm plate-voltage dropping and filtering resistor.
- $R_3$  — Audio load resistor (100,000-ohm or smaller).
- $R_4$  — 20,000-ohm or smaller cathode resistor.
- $SW_1$  — Single-pole toggle switch (audio "On-Off").

### Beat Oscillators and Heterotone Modulators for Code Reception

● A beat oscillator is always the companion to the second detector in amateur-band super-

# Receiver Circuit Design

hets, being used for heterodyne action in the detector circuit for c.w. telegraph reception. The oscillator circuits themselves are of the same types as those used for the frequency conversion in the high-frequency end of the receiver, but tuned near to the i.f. frequency. The oscillator may be coupled to the second detector through a small coupling condenser, as suggested in Fig. 626, or by other methods shown in the receivers described in Chapter Seven. One consideration in the beat oscillator which is especially important is that every precaution should be taken to prevent its output, particularly harmonics of its fundamental frequency, from reaching the earlier circuits of the receiver. This is taken care of by proper shielding and filtering of its supply circuits, and by operating it at as low a plate voltage as permissible for good beat-note strength.

Since amateur c.w. telegraph signals are required to be unmodulated c.w. on all bands below 30 mc., the c.w. beat-note obtained with a heterodyne oscillator is a piercing tone of practically a single frequency. This is somewhat fatiguing in long sessions of operation, although it may be varied in pitch by adjustment of the beat-oscillator frequency. The character of the sound as well as its actual audio power may be improved by adding double-sideband tone modulation in an i.f. amplifier stage preceding the final detector. This is accomplished by an audio-frequency oscillator or tone generator used to modulate one of the i.f. amplifier tubes. A practical circuit which has been used successfully in the i.f. stage following the crystal filter in an S.S. superhet receiver is shown in Fig. 627. In this arrangement, screen-grid modulation is used and the effect is much the same as if the same type of modulation had been applied to the signal at the transmitter. The tone should be heard only when a signal passes through the i.f. amplifier, of course, since the tuned i.f. circuits will not transmit the audio frequency except as sidebands on the signal carrier. The actual audio output from the second detector is greater when the modulated signal is heterodyned by the beat oscillator than for the same signal unmodulated, because additional audio power is produced by beats between the c.w.

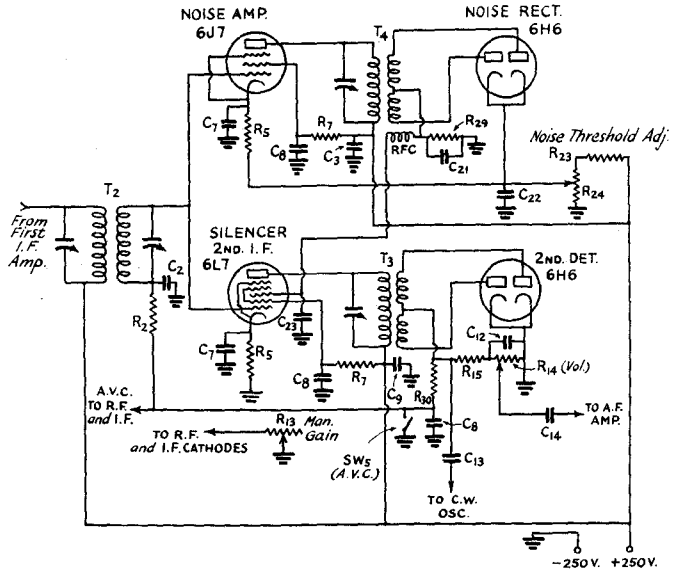

FIG. 628—SILENCER CIRCUIT APPLIED TO THE SECOND I.F. STAGE OF A TYPICAL SUPERHET. THIS CIRCUIT IS NOT ADAPTABLE TO RECEIVERS IN WHICH A COMMON BIAS CIRCUIT IS USED FOR I.F. AND AUDIO CONTROL GRIDS. THE NEGATIVE-B OF THE HIGH-VOLTAGE SUPPLY MUST BE GROUNDED AT THE FILTER OUTPUT

- C<sub>2</sub>—0.01- $\mu$ fd. grid by-pass condensers, 200-volt tubular.
- C<sub>3</sub>—0.01- to 0.1- $\mu$ fd. plate by-pass condensers, 400-volt tubular.
- C<sub>7</sub>—0.1- $\mu$ fd. cathode by-pass condensers, 200-volt tubular.
- C<sub>8</sub>—0.01- to 0.1- $\mu$ fd. screen by-pass condensers, 400-volt tubular.
- C<sub>9</sub>—0.25- $\mu$ fd. main by-pass condenser, 600-volt tubular.
- C<sub>12</sub>—50- $\mu$ fd. detector load by-pass, mica midget.
- C<sub>13</sub>—50- $\mu$ fd. beat osc. coupling condenser, mica midget.
- C<sub>14</sub>—0.1- $\mu$ fd. detector output coupling condenser, 200-volt tubular.
- C<sub>21</sub>—0- to 250- $\mu$ fd. noise rectifier load by-pass, mica midget.
- C<sub>22</sub>—0.1- $\mu$ fd. threshold resistor by-pass, 200-volt tubular.
- C<sub>23</sub>—50- $\mu$ fd. silencer r.f. by-pass, mica midget.
- R<sub>2</sub>—100,000-ohm grid filtering resistor, 1/2-watt.
- R<sub>5</sub>—350- to 1000-ohm cathode resistors, 1/2-watt.
- R<sub>7</sub>—100,000-ohm screen-voltage dropping resistors, 1/2-watt.
- R<sub>13</sub>—5000-ohm manual r.f. gain control.
- R<sub>14</sub>—1-megohm volume control.
- R<sub>15</sub>—50,000-ohm detector load resistor, 1/2-watt.
- R<sub>23</sub>—20,000-ohm threshold bleeder resistor, 1-watt.
- R<sub>24</sub>—5000-ohm threshold control potentiometer, volume-control type.
- R<sub>29</sub>—100,000-ohm noise rectifier load resistor, 1/2-watt.
- R<sub>30</sub>—1-megohm a.v.c. filter resistor, 1/2-watt.
- RFC—20-millihenry r.f. choke.
- T<sub>2</sub>—Double air-tuned i.f. transformer (Hammarlund ATT-465).
- T<sub>3</sub> and T<sub>4</sub>—Single air-tuned full-wave diode coupling transformers (Sickles 456-kc.).

oscillator and the sidebands produced by the tone modulation. Output measurements show this increase in power to be 50% and more, while the aural effect makes the signal sound much louder. The tone modulation should be applied in a stage following the crystal filter. Otherwise, the sidebands will be largely attenuated by the selectivity of the filter circuit. In applying this heterotone system to a receiver, particular care must be taken to prevent output of the tone oscillator from reaching the audio circuits directly, and to prevent c.w. beat oscillator voltage from reaching the earlier i.f. circuits. Otherwise, strong continuous tone output will result whether a signal is present or not. The audio oscillator should be physically remote from the audio amplifier circuits, preferably at the opposite side of the receiver. There may be a

slight vestigial continuous tone in the output but it should be so weak as not to mask even faint signals.

### Electrical Noise Interference Reduction

● Much of the interference experienced in reception of amateur signals is caused by domestic and electrical equipment, and automobile ignition systems. Ignition interference is especially troublesome on frequencies above 7 mc. The interference is of two types in its effects. The first is of the "hiss" type consisting of overlapping pulses, similar in nature to the receiver noise previously discussed. It is largely reduced by high selectivity in the receiver, especially for code reception. The second is the "pistol shot" or "machine gun" type, consisting of separated impulses of high amplitude. Both types usually originate as highly damped waves in the receiver circuits as the result of shock excitation, and are of equal effect over any one band. The "hiss" type of interference is usually caused by commutator sparking in d.c. and series a.c. motors, while the "shot" type results from separated spark discharges (a.c. power leaks, switch and key clicks, ignition sparks, and the like).

They differ in one important aspect as they affect the receiver circuits. With the "hiss" type, both the effective (r.m.s.) and peak voltage values are reduced as the square-root of the ratio of reduction in receiver effective band-width; but with the "shot" type of interference, while the r.m.s. voltage value varies as the square-root of the effective band-width, the peak value is reduced in direct proportion to the reduction in band-width.

This occurs because the damped wave trains resulting from the impulses are prolonged as the selectivity is increased and will overlap if the selectivity is made high enough. This accounts for the continuous "ringing" effect noticed with crystal-filter receivers when there is severe spark interference.

Both "hiss" and "shot" interference may be reduced by use of a receiving antenna system of the "noise reduction" type, where the antenna proper is located remotely from the noise sources and connected to the receiver by a balanced or shielded transmission line which has small pick-up. A directional system is particularly effective. Such systems are described in Chapter Sixteen. Other methods may be applied in the receiver itself.

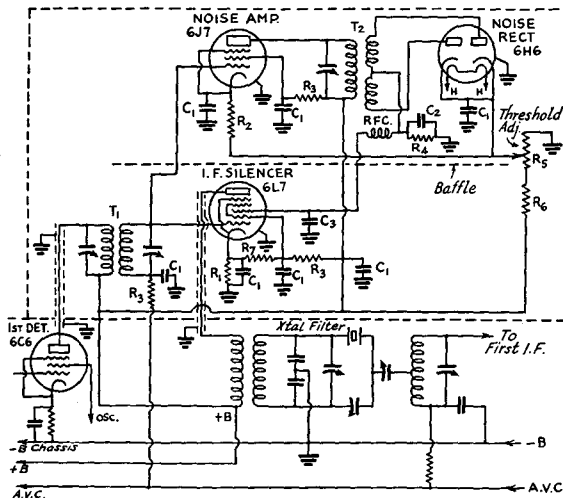

FIG. 629 — CIRCUIT OF THE SILENCER APPLIED AHEAD OF THE CRYSTAL FILTER IN A SINGLE-SIGNAL SUPERHET. THE SAME BIAS REQUIREMENTS APPLY AS FOR FIG. 628

- C<sub>1</sub> — 0.1- $\mu$ fd. tubular by-passes.
- C<sub>2</sub> — 100- $\mu$ fd. mica.
- C<sub>3</sub> — 50- $\mu$ fd. mica.
- R<sub>1</sub> — 2000-ohm  $\frac{1}{2}$ -watt.
- R<sub>2</sub> — 300-ohm  $\frac{1}{2}$ -watt.
- R<sub>3</sub> — 100,000-ohm,  $\frac{1}{2}$ -watt.
- R<sub>4</sub> — 100,000-ohm diode load resistor.
- R<sub>5</sub> — 2000- or 3000-ohm variable, volume control type (Yaxley).
- R<sub>6</sub> — 30,000-ohm 2-watt.
- R<sub>7</sub> — 50,000-ohm  $\frac{1}{2}$ -watt.
- T<sub>1</sub> — Standard double-tuned i.f. transformer to tune to the receiver's intermediate frequency (National 456 kc. or equivalent).
- T<sub>2</sub> — Single-tuned full-wave diode transformer for receiver's intermediate frequency (Sickles 456 kc. or similar).

# Receiver Circuit Design

## Noise-Silencing I.F. System

● One method which is particularly effective against "shot" type interference is the noise-silencer applied to the i.f. circuit of a superhet. This system operates to make the noise pulses "commit suicide" before they have a chance to reach the second detector. Fig. 628 gives the circuit of this silencer applied to the second i.f. stage. Noise voltage in excess of the desired signal's maximum i.f. voltage is taken off at the grid of the i.f. amplifier, amplified by the noise amplifier stage

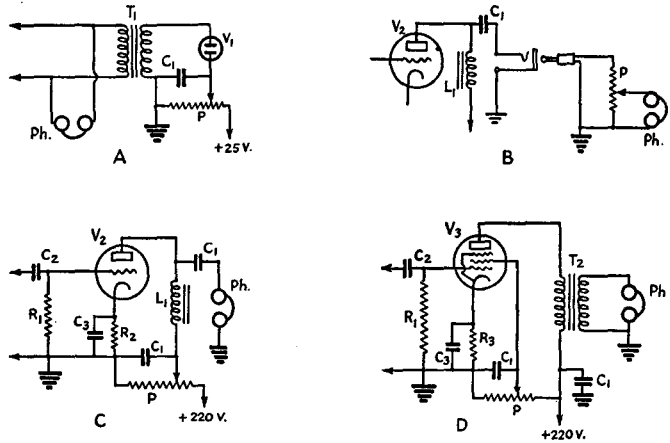

FIG. 631 — OUTPUT LIMITER CIRCUITS

- $C_1$  — 0.25  $\mu$ f.
- $C_2$  — 0.01  $\mu$ f.
- P — 50,000-ohm limiter control (preferably wire wound).
- $R_1$  — 0.5 meg.
- $R_2$  — 2000 ohms.
- $R_3$  — 600 ohms.
- $V_1$  — 1-watt neon tube (see text).
- $V_2$  — 56 or 76.
- $V_3$  — 41 pentode.
- $T_1$  — Step-up transformer (high ratio inter-stage).
- $T_2$  — Output transformer.
- $L_1$  — 15-henry choke.
- Ph — Telephones (20,000-ohm impedance; 2,000-ohm resistance).

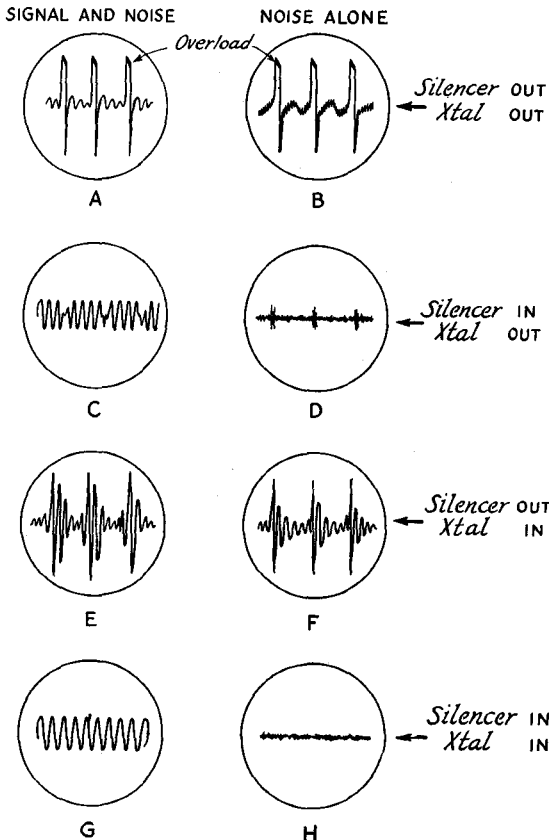

FIG. 630 — AUDIO OUTPUT OSCILLOGRAMS ILLUSTRATING THE NOISE REDUCTION OBTAINED WITH THE SILENCER CIRCUITS OF FIGS. 628 AND 629 IN C.W. CODE RECEPTION

and rectified by the full-wave diode noise rectifier. The noise circuits are tuned to the i.f. The rectified noise voltage is applied as a pulse of negative bias to the No. 3 grid of the 6L7 used as an i.f. amplifier, wholly or partially disabling this stage for the duration of the individual noise pulse, depending on the amplitude of the noise voltage. The noise amplifier-rectifier circuit is biased, so that rectification will not start until noise voltage exceeds the desired-signal amplitude, by means of the "Threshold Control". For reception with automatic gain control, the a.g.c. voltage is also applied to the grid of the noise amplifier to augment this threshold bias. This system of noise silencing gives signal-noise ratio improvement of the order of 30 db (power ratio of 1000) with heavy ignition interference, raising the signal-noise ratio from -10 db without the silencer to +20 db with the silencer in a typical instance. Oscillograph patterns A and C of Fig. 630 represent the performance in "straight"

superhet reception, the signal modulation being 100%.

In a receiver using a crystal filter, application of the noise silencer to a subsequent stage is

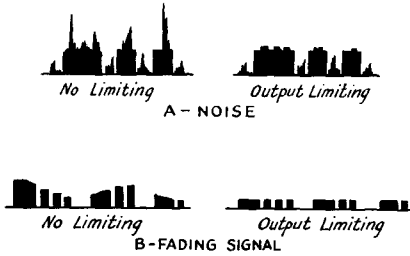

FIG. 632—ILLUSTRATING LIMITER ACTION WITH NOISE-PEAK INTERFERENCE AND WITH A FADING SIGNAL

ineffectual with noise interference of the pulse type, because of the reduction in peak-to-effective voltage ratio and elongation of the noise wave trains in the high-selectivity circuit, as described in the previous section. The silencer must be able to get at the noise before this occurs. That is, the silencer circuit must precede the crystal filter. A practical circuit for accomplishing this is shown in Fig. 629. It operates in the same manner as the second i.f. stage arrangement, except that the signal gain of the 6L7 stage is reduced and its noise-control sensitivity increased to obtain action at the lower amplification level. This is accomplished by reduced screen voltage obtained from the screen-cathode voltage divider, which also maintains relatively high cathode-drop bias on the signal and silencer grids. The further improvement in signal-noise ratio accomplished by combining the silencer circuit and crystal filter for c.w. code reception is shown by oscillograms E and G of Fig. 630. This silencer arrangement is used in the S.S. receiver described in the next chapter. (For more complete descriptions refer to articles in Feb., March, April, and Oct., 1936, issues of *QST*.)

### Audio Limiter Circuits

● A considerable degree of noise reduction in code reception also can be accomplished by limiter arrangements applied to the output circuits of both superhet and regenerative receivers. Such limiters also maintain the signal output nearly constant with fading, the effect for both noise and signal limiting being shown

in Fig. 632. Diagrams of several output limiter circuits are shown in Fig. 631. In the circuit of A, a neon tube is connected effectively in parallel with the headset, through the audio transformer  $T_1$ , and sufficient d.c. voltage is applied to the tube so that it will ionize and short-circuit the audio output on peaks exceeding the desired signal level. The tube should have the usual limiting resistor in the base removed. This arrangement is less effective than the others shown. Circuit B employs a triode tube which is operated at practically saturation signal excitation at normal plate voltage, with the output to the 'phones tapped to give a comfortable audio level. Increase in signal strength or noise peaks will then be ineffectual. This is not as satisfactory as the triode circuit of C, in which the tube is operated at reduced plate voltage (approximately 10 volts) so that it saturates at a lower signal level. The arrangement of D has the best limiting characteristics, and is preferred. A pentode audio tube (Type 41) is operated at reduced screen voltage (35 volts or so), so that output power remains practically constant over a grid excitation voltage range of more than 100-to-1. The output limiter systems are simple and adaptable to most all receivers. However, they cannot prevent noise peaks from overloading previous circuits and do not bring the noise amplitude down below the level of the signal as

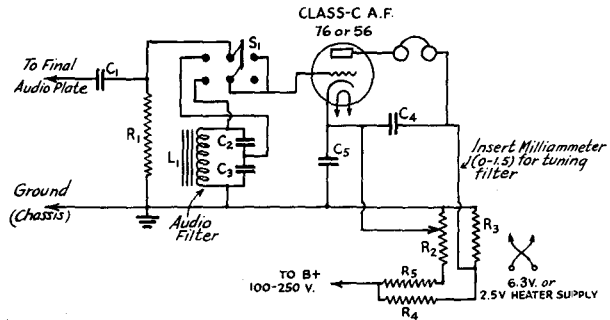

FIG. 633—THE CLASS-C AUDIO AMPLIFIER CIRCUIT WITH A SELECTIVE AUDIO FILTER

- $C_1$ —1- $\mu$ d. paper blocking condenser.
- $C_2$ —0.01- $\mu$ d. filter tuning condenser, paper or mica. (Depends on  $L_1$ .)
- $C_3$ —1 to 4- $\mu$ d. filter coupling condenser, paper. (Depends on  $L_1$ .)
- $C_4$ —1- $\mu$ d. a.f. by-pass, paper.
- $C_5$ —1- $\mu$ d. cathode by-pass, paper.
- $R_1$ —100,000-ohm 1-watt.
- $R_2$ —25,000-ohm wire-wound potentiometer.
- $R_3$ —5000-ohm 2-watt.
- $R_4$ —50,000-ohm 2-watt.
- $R_5$ —25,000-ohm 2-watt.
- $L_1$ —Inductance which with  $C_2$  will resonate at 250 cycles (1.5-henry choke).
- $S_1$ —D.p.d.t. switch to cut out audio filter.



## Receiver Circuit Design

does the i.f. silencer method. They are ineffectual with shock excitation of a previous high-selectivity circuit. (Refer to article by H. A. Robinson, Feb., 1936, *QST*, for details.)

### The Class-C Audio Amplifier

● Another type of output circuit for taking out background noise of amplitude *lower* than the signal amplitude is diagrammed in Fig. 633. This arrangement is also helpful in restoring aural intelligibility to code signals after they have passed through circuits of extreme selectivity, which tend to remove the keying modulation, as illustrated in Fig. 634. The amplifier is operated Class-C; that is, with negative bias greater than cut-off. This bias is adjusted so that only the signal peaks above cut-off bias value are effective. Consequently, background noise below this level is prevented from reaching the 'phones. This system is especially useful in traffic reception on the lower-frequency bands where fading is

not excessive. The signal will drop out if it fades below cut-off grid-voltage level, of course.

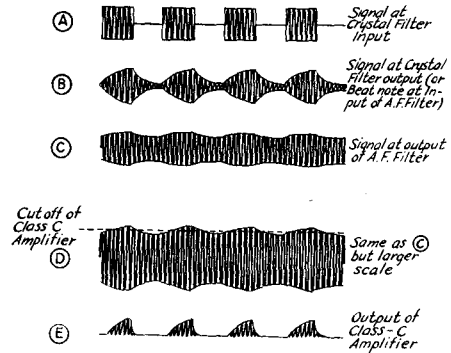

FIG. 634—ILLUSTRATING THE ACTION OF THE CLASS-C AUDIO AMPLIFIER IN RESTORING INTELLIGIBILITY TO A CODE SIGNAL "DEMODULATED" BY HIGH-SELECTIVITY CIRCUITS

# 7

## ***The Construction of Receivers***

### **BUILDING, OPERATING AND SERVICING MODERN TYPES**

**H**AVING examined the fundamentals of receiver design, we are now ready to consider the construction of representative receivers of the various types now in general use. The construction and operation of a number of representative types is described in this chapter, beginning with the simpler receivers and continuing through advanced superheterodyne models. Most of the parts used in the simpler receivers can be adapted later to use in the more intricate sets; thus it is possible for the neophyte to pick out a simple and inexpensive design for his initial attempt, one which he will find relatively easy to get working, at the same time realizing that the investment for the equipment in it will not be wasted, even though it is probable that the simpler outfit will not be retained permanently. All of the sets described in this chapter are thoroughly practicable, capable of giving excellent service in regular amateur operation if carefully built and correctly operated.

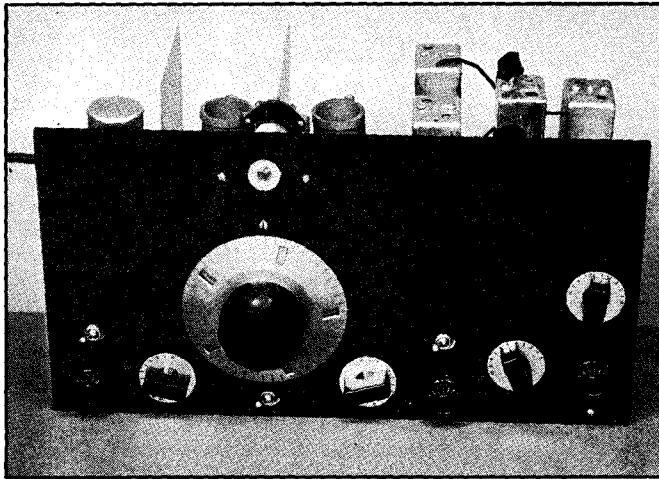

**FIG. 701 — A HIGH-PERFORMANCE AMATEUR TYPE SUPERHET INCORPORATING VARIABLE-SELECTIVITY CRYSTAL FILTER AND NOISE-SILENCER CIRCUITS. ITS CONSTRUCTION IS COMPLETELY DESCRIBED IN THIS CHAPTER**

#### **Tools**

● While it is possible to put a set together with the aid of only the proverbial jackknife, a few good tools of the proper sort will be found invaluable in saving time and helping to make a good job mechanically. The following list is typical of the tools which most amateurs consider adequate:

Soldering iron (preferably electric)  
Large and small side-cutting pliers  
Large and small screwdrivers  
Hand drill stock with a few drills of different sizes (Nos. 11, 18 and 28 will be most useful)  
File (not too large)  
Knife (Boy-Scout kind)  
Hammer  
Vise (the small 4" size will do)  
Steel rule (6" or 12")

With these tools it is possible to construct practically any of the apparatus ordinarily built at home. Others will be found useful at times, however. A small tap-holder, a die-holder and three or four taps and dies covering the 6-32, 8-32 and 10-32 sizes can be obtained from a hardware store at reasonable cost. With the dies you can thread brass rod and run over threads that become "bunged-up" on machine screws. With the taps you can thread the holes you drill so that they will take machine screws to hold the apparatus you wish to mount. A hacksaw, reamer, center-punch, scriber, tweezers, square and some other inexpensive tools are also desirable but not entirely necessary.

In building equipment for experimental purposes and for temporary use it is just

# . . . . . The Construction of Receivers

as desirable to use system in laying out the apparatus and in wiring up as when the more permanent panel job is built. Some square "breadboards," a bunch of General Radio plugs and jacks, Fahnestock clips, some scrap bakelite pieces for building terminal boards, angles for supports and an assortment of different sized brass machine screws, wood screws, nuts, and washers will make it easy to build up and try out new circuits. It is a good idea to keep some hook-up wire on hand, and various sized spools of magnet wire will prove useful in doing temporary wiring if you are an experimenter.

A metal chassis is preferable for permanent equipment, both for mechanical rigidity and electrical shielding. Bases can be formed from aluminum sheet, such material of approximately 1/16-inch to 3/16-inch thickness being easily worked in the home workshop. Alternatively, standard bases of "Electroloy," cadmium plated steel, "radio metal," etc., can be purchased in a variety of dimensions to fit almost any design. Panels of various fiber and metal compositions also can be obtained cut to suitable dimensions. With these economical foundation units, much of the tedious work of construction is escaped.

A table of drill sizes giving the proper numbered drill to use for passing a screw through a panel or for tapping to take a certain size of machine screw is included in the Appendix. Only the sizes most used in radio construction work are given.

## Soldering and Wiring

● In wiring different pieces of apparatus a neatly soldered job will repay the builder in good appearance and reliable operation. Good connections may be made without solder, but a well-soldered joint has low contact resistance.

Making good soldered joints is a quite simple matter. A few points should be kept in mind for best results. A hot well-tinned soldering iron, clean, bright surfaces, and a *small* amount of rosin-core solder will do the trick. Tinning the parts to be soldered before completing a joint will be helpful.

Soldering flux keeps the clean surface from becoming oxidized when heat is applied. Acid fluxes or soldering pastes are especially to be avoided. They are good for mending tin pans and gutter pipes but cause corrosion of electrical connections. The melted "paste" can cause a set to operate poorly or to become inoperative by adding leakage paths across coils and condensers. Use lump or powdered rosin that can be obtained for a dime from any drug store, or buy "rosin-core" solder.

"Tinning" the soldering iron is done by filing the point bright and clean and rubbing it in hot solder with a little flux until the point is covered with clean solder. Scrape connections with a knife or file before soldering, to save time and make a joint good electrically and mechanically. The soldering iron must be re-tinned occasionally if it becomes overheated. It should always be used when very hot, but not allowed to become red hot. A hot iron makes soldering easy.

Solder should not be carried to the work on the tip of the iron when using rosin-core solder; the prolonged heat of the iron ruins the flux, and an improperly soldered joint often results. Instead, the parts should first be tinned, then connected together to provide an adequate mechanical joint, and finally heated by the iron until the parts are hot enough to melt the solder and cause liquid solder to flow around the joint. Only in this way can permanent, uniform, resistance-free soldered connections be made.

Many skillful constructors wire a receiver in the following order: First, all filament or heater connections are wired with twisted pair (in the case of a.c. circuits) placed, wherever possible, in the angles formed by the top and sides of the chassis, and away from other circuits. Second, all grid and plate connections are run as directly and with as short leads as possible from the tube socket or cap to the indicated part (preferably to the condenser, in a tuned circuit), or spaced from, or run at right angles to, other circuit elements. Finally, the plate and grid return circuits, with their various filter elements, are placed in a neat, orderly and non-conflicting array. By-pass condensers should be placed right at the socket terminal or by-passed element, choke coils should be mounted so that their fields do not mutually interact, and as much spacing between the parts in adjacent stages should be provided as the general design permits. If ordinary push-back wire is used for plate and grid connections in high-frequency sets, it should be kept away from the chassis or other parts, since the insulation at high frequencies is none too good. Spaghetti or varnished cambric insulation is satisfactory at the ordinary amateur frequencies.

The underlying thoughts to keep in mind in wiring the receiver are that damaging reactions between stages due to stray coupling between circuit elements should be avoided, that too much dependence must not be placed on ordinary forms of insulation in marshalling the elusive high frequency currents, and that the resistance introduced by a single improperly

soldered connection can ruin the performance of the entire receiver.

## A Simple Two-Tube Triode Receiver

● A two-tube regenerative receiver using triodes as detector and audio amplifier is shown

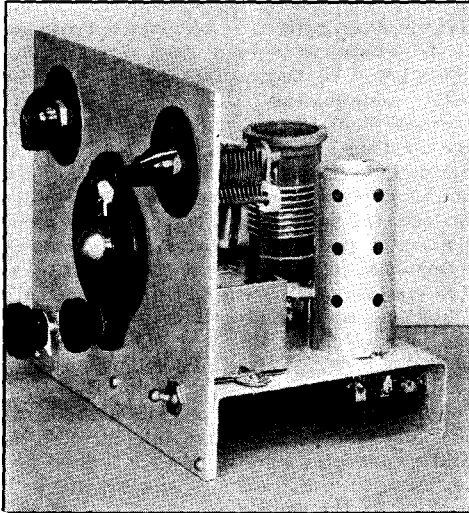

FIG. 702 — PANEL VIEW OF THE TWO-TUBE TRIODE RECEIVER

in Figs. 702 and 703. This little set is of simple yet sturdy mechanical construction and, although somewhat less sensitive than more complicated types, is capable of bringing in DX amateur signals under favorable conditions. The circuit is given in Fig. 704. The chassis (base) is made from a piece of 1/16-inch aluminum sheet 8 inches square. The front and back sides are bent, as shown in the illustrations, to form a sub-base space 1 1/2 inches deep, leaving the base 8 inches wide by 5 inches from front to back. These bends are made by first scoring the aluminum with a sharp chisel along the lines where the bends are to be made (1 1/2 inches from two opposite edges), and then folding by hand pressure with the sheet clamped at the scored line between two boards in a vise. The panel is a piece of 1/8-inch aluminum, 8 inches wide by 7 inches high. Viewed from the front, the controls at

the top of the panel are audio volume (left) and band-set condenser (right). The single-hole mounting controls at the bottom, which also aid in fastening the panel to the base, are regeneration (left) and plus-B or "send-receive" switch (right). The large dial in the center is the main tuning control.

Mounted on the base, centered along a line 1 1/4 inches from the rear edge, are the detector tube socket (right), the coil socket (center) and the audio tube socket (left). The two tube sockets are the sub-base type, mounted with their filament terminals to the rear and centered under 1 1/8-inch diameter holes cut in the aluminum base with an extension cutter. The centers of these holes are 1 1/8 inches from the right and left edges of the base, respectively. Also mounted on the base is the audio coupling transformer, immediately under the band-set condenser. The coil socket, between the two tube sockets, is mounted above the base on 5/8-inch metal pillars which are furnished with the Hammarlund coil socket. Its large pin terminals (grid and ground) are toward the detector.

Underneath the base are the remaining circuit components specified under the circuit diagram in Fig. 704. These are placed as convenient, with short leads in the portions of the circuit carrying radio-frequency current, in accordance with the wiring practice previously described. The antenna-coupling condenser C<sub>3</sub>, a small compression type, is soldered between one antenna terminal on the strip at the back of the base and a soldering lug on the four-

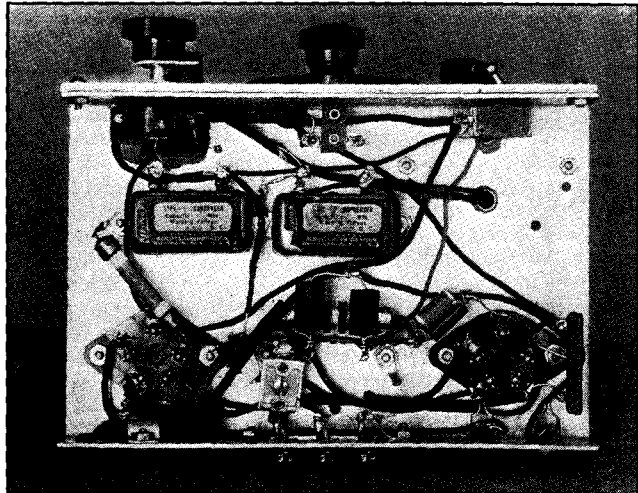

FIG. 703 — SHOWING THE SUB-BASE ARRANGEMENT OF THE TRIODE RECEIVER

# . . . . . The Construction of Receivers

terminal strip mounted  $1\frac{1}{4}$  inches in from the rear of the base. This latter strip also supports the plate r.f. choke and plate by-pass condensers. A single terminal lug at the front supports the plus-B end of the screen-voltage divider resistor  $R_4$ , the other end of this resistor connecting to the left-hand terminal (as viewed from the bottom) of the regeneration-control resistor,  $R_3$ . Note that the base is cut out above this variable resistor so that it projects partly through the top. The filament center-tap resistor  $R_2$  has its two outer terminals connected directly to the heater lugs on the detector socket by short lengths of stiff wire. Its center-tap is connected to a convenient soldering lug held in contact with the metal base by a socket-mounting screw.

All "ground" connections are made to soldering lugs in contact with the metal chassis by the mounting screws of the various components. The chassis is thus used for connection between the various ground points in the set. This method is generally recommended in receivers assembled on metal chasses, without further connecting leads between the ground points. Note that this also applies in the tuned circuit, where the tuning condensers are mounted with their rotor bearings in contact with the metal panel, so that only the stators are connected by a wire lead.

When the wiring of the receiver is completed and rechecked for possible errors, or poor soldered connections and short-circuits, the 80-meter band coil is plugged in, the tubes are inserted in the sockets and the filament supply connected. A 2.5-volt 2-ampere (or more) a.c. filament supply (transformer) should be used for Type 56 tubes, or a 6.3-volt 1-ampere transformer or 6-volt storage battery for Type 76 tubes. The plate-current drain of this set is quite low, so that it is satisfactory to use B-batteries. Two or three 45-volt blocks of the heavy-duty type connected in series will give long service, especially if care is taken to open the "B" switch,  $SW_1$ , whenever the receiver is not in use. If a power pack is to be used for all-a.c. operation, it should be of the type intended for regenerative receivers, as described in Chapter Fifteen. Ordinary broadcast-receiver type power packs are likely to cause

excessive hum, especially of the tunable variety, when used with regenerative receivers.

The headset is connected to the output terminals. If magnetic 'phones are used, the output arrangement should be as shown for this type in Fig. 704. If crystal 'phones (Brush) are used, however, the output circuit should be as shown at the right in Fig. 704. *Crystal*

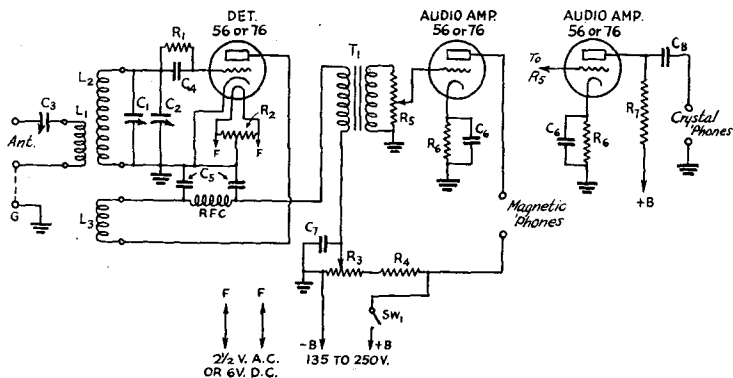

**FIG. 704 — THE SIMPLE CIRCUIT OF THE TWO-TUBE TRIODE RECEIVER**

- $L_1, L_2, L_3$  — Three-winding receiver coil kit (Hammarlund SWK-6 — see table below).
  - $C_1$  — 140- $\mu$ fd. midget variable band-set condenser (Hammarlund MC-140-S).
  - $C_2$  — 20- $\mu$ fd. midget variable tuning condenser (Hammarlund MC-20-S).
  - $C_3$  — 50- $\mu$ fd. adjustable trimmer-type condenser.
  - $C_4$  — 100- $\mu$ fd. mica grid condenser.
  - $C_5$  — 100- $\mu$ fd. mica plate by-pass condensers.
  - $C_6$  — 0.5- $\mu$ fd. or larger audio cathode by-pass condenser (paper).
  - $C_7$  — 0.5- $\mu$ fd. regeneration control by-pass (paper).
  - $C_8$  — 0.1- $\mu$ fd. audio coupling condenser for crystal headset.
  - $R_1$  — 2-megohm grid leak.
  - $R_2$  — 75-ohm filament center-tap resistor (for a.c. operation).
  - $R_3$  — 50,000-ohm variable resistor (regeneration control).
  - $R_4$  — 50,000-ohm 1-watt bleeder resistor.
  - $R_5$  — 500,000-ohm potentiometer (volume control).
  - $R_6$  — 2500-ohm 1-watt audio amplifier cathode resistor.
  - $R_7$  — 50,000-ohm 1-watt coupling resistor for crystal headset.
  - RFC — 2.5-millihenry r.f. choke (National Type 100).
  - $SW_1$  — Single-pole single-throw toggle switch.
  - $T_1$  — Interstage audio transformer (UTC Type CSI).
- If it is desired to build the coils,  $L_1, L_2, L_3$ , they can be wound with No. 30 double-silk-covered wire on standard  $1\frac{1}{2}$ -inch plug-in forms, allowing about 1/16-inch between windings.  $L_2$  should be wound at the top of the form, with the grid terminal at the top. The remaining windings and terminals follow progressively downward as shown. The turns-per-winding specifications are as follows:

	$L_2$	$L_3$	$L_1$	Frequency Band
No. 1 . . . . .	70	20	10	1750-Kc.
No. 2 . . . . .	30	10	10	3500-Kc.
No. 3 . . . . .	11	7	5	7000-Kc.
No. 4 . . . . .	5	5	5	14,000-Kc.

# The Radio Amateur's Handbook . . . . .

'phones cannot be connected in series with the d.c. plate supply, nor should they be connected with d.c. voltage across them in a shunt-fed output circuit. As shown in the crystal output diagram, the blocking condenser  $C_7$  isolates

used and must be determined by trial. In general, a receiving antenna of 50-foot or so length is satisfactory. In tuning the receiver, the band-set condenser  $C_1$  is first slowly adjusted until the desired amateur band is located, after which the band-spread condenser  $C_2$  is used for tuning over the band.

The use of the manufactured ready-wound plug-in coils specified simplifies the construction of the set. If the builder prefers to wind his own coils, the coil specifications given in the table should be followed. If the receiver is to be used for loud-speaker operation, the power audio amplifier stage described farther on can be added.

In case interference from a local broadcasting station should be experienced, a wave-trap tunable to the frequency of the offending station should be connected in the antenna lead, right at the receiver's antenna terminal. This wave-trap is of the same type as that for

which the connections are shown in Chapter Ten. For eliminating broadcast station interference, the wave-trap coil may consist of 40 turns of No. 22 d.c.c. wire close-wound on a

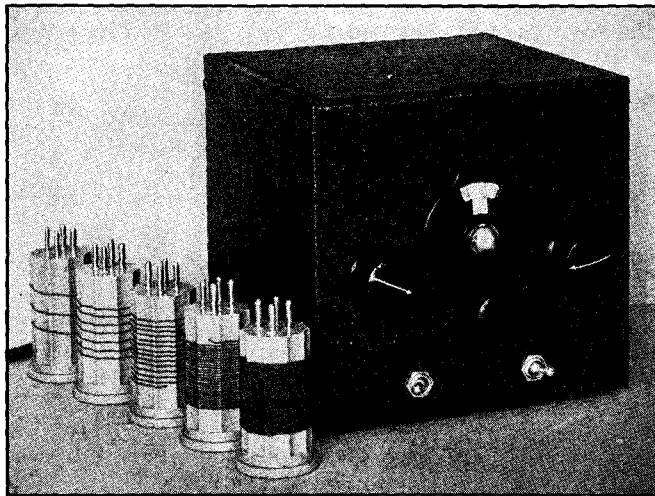

FIG. 705 — THE COMPLETED PENTODE DETECTOR SET WITH ITS PLUG-IN COILS

the 'phones from d.c. while coupling them to the output circuit, across  $R_7$ , for audio-frequency a.c.

The detector should be first tested for oscillation. While the regeneration control is advanced from minimum to maximum with one hand, the grid side of the tuned circuit (stator terminal of the band-set or tuning condenser) should be touched with one finger of the other hand. As the regeneration control approaches maximum, there should be a point at which a distinct "plunking" sound is heard in the 'phones when the grid circuit is touched. Further advance of the regeneration control may cause a squealing or howling sound with the antenna disconnected. If there is no evidence of oscillation, a check should be made to make sure the tickler is properly connected.

After the oscillation test shows the detector to be operating, the antenna should be connected and the controls manipulated to tune in signals. The antenna coupling condenser should be set slightly below maximum (adjustment screw backed off one or two turns to the left). Some adjustment of the antenna coupling condenser  $C_3$  may be necessary to give smooth regeneration over a given band. This depends on the particular receiving antenna

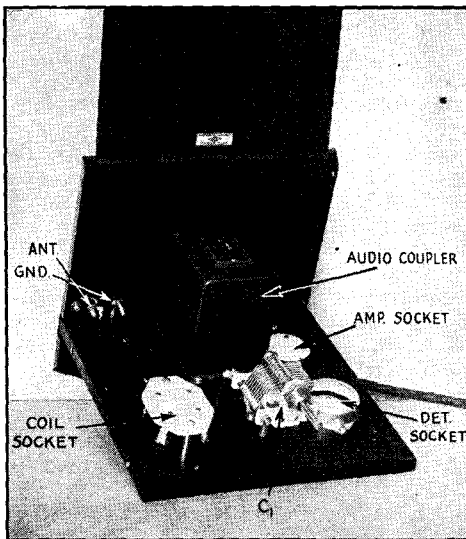
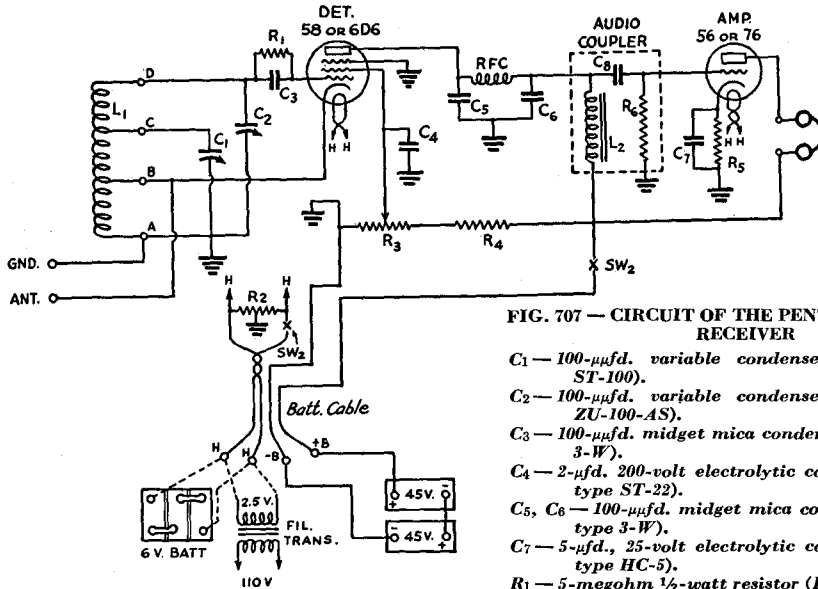

FIG. 706 — TOP VIEW OF THE BASE ASSEMBLY

# . . . . . The Construction of Receivers

3-inch diameter cardboard or bakelite tube, connected in parallel with a 350- $\mu$ fd. tuning condenser. Alternatively, a manufactured wave-trap unit for the broadcast band can be purchased complete.

parts, as well as giving the set an attractive and professional appearance. Ordinarily the mechanical work in drilling large holes for tube sockets, dials, and other parts would require tools which the average beginner in amateur



**FIG. 707 — CIRCUIT OF THE PENTODE DETECTOR RECEIVER**

- C*<sub>1</sub> — 100- $\mu$ fd. variable condenser (National type ST-100).
- C*<sub>2</sub> — 100- $\mu$ fd. variable condenser (Cardwell type ZU-100-AS).
- C*<sub>3</sub> — 100- $\mu$ fd. midget mica condenser (Dubilier type 3-W).
- C*<sub>4</sub> — 2- $\mu$ fd. 200-volt electrolytic condenser (Sprague type ST-22).
- C*<sub>5</sub>, *C*<sub>6</sub> — 100- $\mu$ fd. midget mica condensers (Dubilier type 3-W).
- C*<sub>7</sub> — 5- $\mu$ fd., 25-volt electrolytic condenser (Sprague type HC-5).
- R*<sub>1</sub> — 5-megohm  $\frac{1}{2}$ -watt resistor (IRC type B- $\frac{1}{2}$ ).
- R*<sub>2</sub> — 75-ohm center-tap resistor (Electrad).
- R*<sub>3</sub> — 50,000-ohm potentiometer (Centralab type 72-103).
- R*<sub>4</sub> — 25,000-ohm 2-watt resistor (IRC type F-2).
- R*<sub>5</sub> — 2000-ohm 1-watt resistor (IRC type B-1).
- SW*<sub>1</sub>, *SW*<sub>2</sub> — Single-pole single-throw toggle switches.
- L*<sub>2</sub>, *C*<sub>8</sub>, *R*<sub>6</sub> — Audio coupler (National type S-101). Suitable values are: *L*<sub>2</sub>, 500 henrys; *C*<sub>8</sub>, .01  $\mu$ fd.; *R*<sub>6</sub>, 0.5 megohm.
- RFC* — Radio-frequency choke (National type 100).

### A Shielded Two-Tube Receiver

● Figs. 705 to 710, inclusive, show the construction and circuit of a more sensitive type of simple regenerative receiver in which a pentode type screen-grid tube is used as the detector and a triode as audio amplifier. This set uses a tuning system giving more uniform band-spread than the simple parallel-condenser method of the previous receiver. The tuning system is that of Fig. 603-D in Chapter Six, using a band-set condenser across the whole coil and the band-spread condenser across part of the coil. As shown in the diagram of Fig. 707, the feed-back circuit is the cathode-tap type shown in Fig. 604-D in the preceding chapter. The receiver is intended for headset reception, using magnetic 'phones. If crystal 'phones are to be used, the audio output circuit at the right in Fig. 704 should be incorporated.

The construction of the receiver is almost self-evident from inspection of the photographs. The use of a metal cabinet is highly desirable; not only does it make a solid job mechanically but it also shields the sensitive detector circuit against a.c. induction fields which are present near house wiring and thus it prevents an annoying hum from being picked up. Such a cabinet also protects the receiver

radio does not have, but it happens that the cabinet specified (National Type C-SRR) is available completely drilled in such a fashion that the holes can be utilized for our purpose. It is possible to assemble the complete receiver without drilling a single hole; the only tools needed are a screwdriver and soldering iron.

The winding data for the coils are given in the table, while Fig. 708 illustrates the method of construction. All coil windings occupy exactly the same length on each form, 1  $\frac{1}{2}$  inches. On all except Coil No. 1 the turns must be spaced out to fit the length; No. 1 is close-wound. The spacing is not really difficult; simply wind on the correct number of turns and spread them out uniformly. The taps are made by drilling a hole at the appropriate place, feeding the wire through to the proper pin and cutting it off; then a new piece with its

# The Radio Amateur's Handbook . . . . .

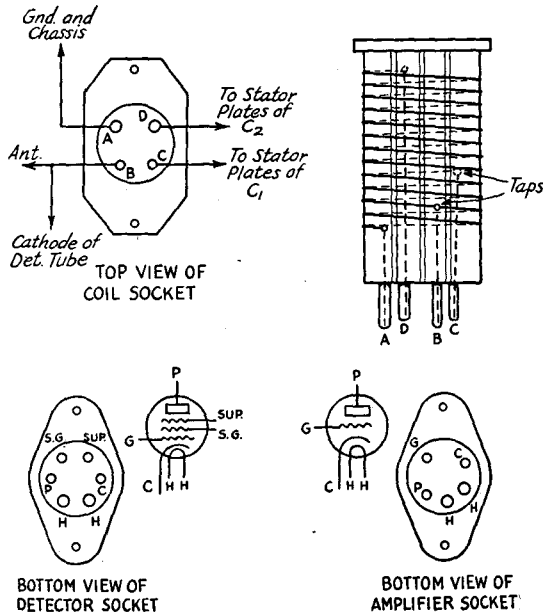

FIG. 708—TUBE AND COIL SOCKET CONNECTIONS, SHOWING THE METHOD OF WINDING THE COILS ACCORDING TO THE FOLLOWING SPECIFICATIONS

end fastened in the same pin (and going back out through the same hole) continues the winding. When the coils are finished, the windings should be coated with Duco cement or similar adhesive, along the coil-form ridges.

The receiver can be operated either with a.c. or d.c. heater supply for the tubes. If 110-volt a.c. supply is available, the detector tube should be a Type 58 and the amplifier a Type 56, and the heater current taken from a 2.5-volt 2- or 3-ampere transformer. In districts where a.c. is not available, Type 6D6 and 76 tubes should be used, and the heater current furnished by a 6-volt storage battery. It is not advisable to use dry cells to heat the filaments of the Type 6D6 and 76 tubes, since the current drain is great, although fair battery life can be secured if the receiver is used intermittently

for only short periods. Four dry cells might be connected in series (negative of one cell to positive of the next, except for the two end cells, which connect to the filament wires in the cable) to give 6 volts.

The "B" supply may be either from batteries or a B-eliminator or power pack.

COIL TABLE

Frequency Range	Total Cathode Spread	
	Turns	Tap
No. 1 1450 to 3400 kc. . . .	60	4
No. 2 3050 to 7100 kc. . . .	27	1 1/4
No. 3 6100 to 14,200 kc. . . .	13	3/4
No. 4 10,600 to 24,000 kc. . . .	7	1/2
No. 5 18,000 to 41,000 kc. . . .	3	1/3

All coils are wound with No. 24 d.s.c. wire, the length of each coil being 1 1/2 inches. The taps are counted off from the lower or ground terminal of the coil. For spreading the amateur bands, use coil No. 1 for 1715-2000 kc., No. 2 for 3500-4000 kc., No. 3 for 7000-7300 kc., No. 4 for 14,000-14,400 kc., and No. 5 for 28,000-30,000 kc.

If batteries are used, 90 volts (two 45-volt blocks) will be sufficient. When a power supply is available, plate voltage up to 250 can be used. The power pack should be of the type designed for regenerative receivers, as described in Chapter 15.

If the set refuses to oscillate, the sensitivity will be poor and no code signals will be heard on the frequencies at which such signals should be expected. It should oscillate easily, however,

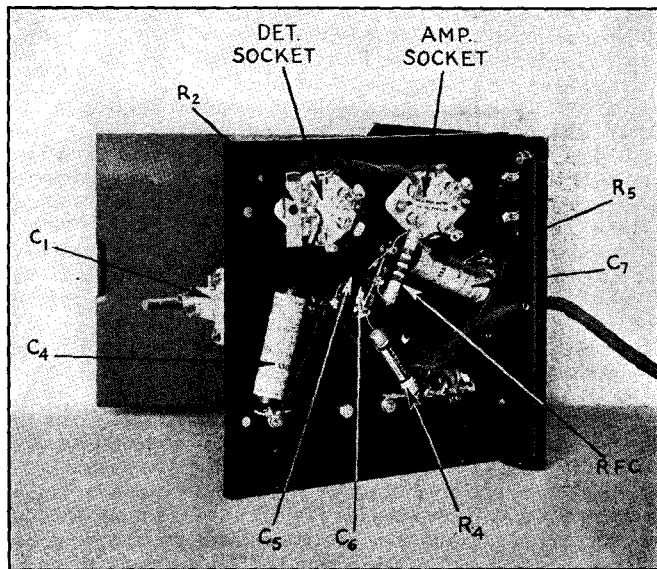

FIG. 709—UNDERNEATH THE CHASSIS, SHOWING THE WIRING BEFORE THE CABINET IS ASSEMBLED



# . . . . . The Construction of Receivers

if the coils are made exactly as shown and the tubes and batteries are good. It sometimes happens that the antenna takes so much energy from the set that it cannot oscillate, this usually resulting in "holes" in the dial where no signals can be picked up. The way

about halfway; and on Coil No. 5 about three-quarters. It is a good plan to make a rough scale from a piece of cardboard and fasten it under the knob controlling  $C_2$  so that you can return to previously-found settings with a minimum of delay.

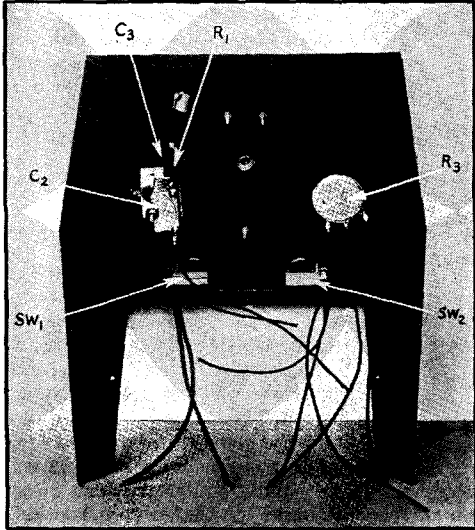

**FIG. 710 — THESE COMPONENTS ARE MOUNTED ON THE BACK OF THE PANEL BEFORE ASSEMBLING THE CABINET**

Sometimes local broadcasting stations cause interference, especially when the lower-frequency coils are being used. A simple but effective cure for such interference is the wave trap described for the triode receiver.

A suitable antenna for this receiver would be 50 to 75 feet long, and as high and clear of surrounding objects as possible. The transmitting antenna may be used for this purpose. The ground lead should preferably be short. A ground to a heating radiator or any of the water piping is good. Do not use gas pipes for grounds, because the joints in these lines often are insulated, particularly at the meter.

(A more detailed description of this receiver is given in, "How To Become A Radio Amateur", published by A.R.R.L.)

to cure this is to use a slightly different length antenna, or to put a small variable condenser in the lead-in, as in the triode receiver.

To cover the 1715-2000-kc. amateur band  $C_2$  should be set at about half capacity. A good way to locate the band is to set  $C_1$  at maximum capacity and tune carefully with  $C_2$  until some of the police stations are heard. These stations operate on 1712 kc., so that once found they become "markers" for the low-frequency end of the band. Further tuning then should be done with the regular tuning dial.

The tuning procedure on the other bands will be about the same as that described above. It will be necessary for you to "locate" each amateur band—one of which will be found on each coil—by searching carefully with  $C_2$ . The 3500-4000-kc. band will be found on Coil No. 2 with  $C_2$  at a little less than half capacity; it will be rather easy to locate this band by setting  $C_1$  at minimum and adjusting  $C_2$  until amateur 'phone stations are heard. Then let  $C_2$  alone and tune with the regular dial, which will cover the whole band. On Coil No. 3 the band will be found when the plates of  $C_2$  are about one-quarter interleaved; on Coil No. 4

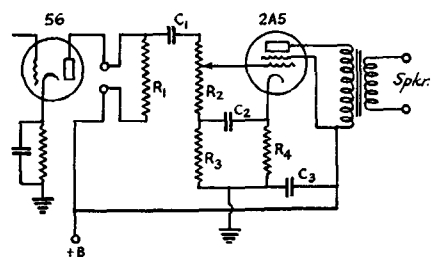

(A)

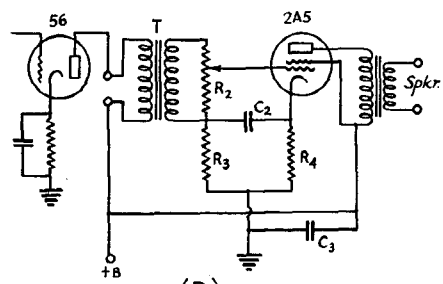

(B)

**FIG. 711 — CIRCUITS OF POWER AMPLIFIERS FOR TWO-TUBE RECEIVERS, THAT OF B BEING PREFERRED**

- $R_1$  — 20,000 ohms, 1 watt.
- $R_2$  — 500,000-ohm potentiometer.
- $R_3$  — 250,000 ohms, 1/2 watt.
- $R_4$  — 400 ohms, 1 watt.
- $C_1$  — .02  $\mu$ d.
- $C_2$  — 1  $\mu$ d., 50 volts.
- $C_3$  — 3  $\mu$ d., 400 volts.
- T — Interstage audio transformer.

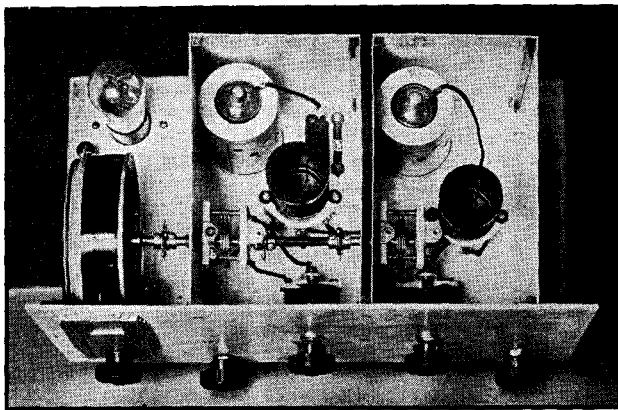

FIG. 712 — PLAN VIEW OF THE "OLD RELIABLE" AUTODYNE WITH SHIELD COVER REMOVED

The detector stage is next to the drum dial. The ganged tuning condensers are mounted on the left-hand wall of each shield. The Isolantite coil sockets are mounted on small pieces of brass tubing which lift them far enough above the base to prevent grounding of the contacts. The detector grid condenser and leak are just behind the coil in the detector compartment. The tubes, also mounted in sub-panel sockets, have individual shields.

### Speaker Output Stage for Two-Tube Receivers

● If increased audio output for loud-speaker operation is desired with either of the foregoing receivers, a pentode power stage can be added. This is feasible only with a.c. power supply, since the power stage requires more plate current than can be furnished economically by B batteries. The diagram of Fig. 711 shows two different circuits which may be used. That of A employs resistance coupling between the first audio stage in the receiver and the power tube, while B has transformer coupling. In either arrangement, the volume control  $R_2$  can be replaced by a 500,000-ohm  $\frac{1}{2}$ -watt fixed resistor if the receiver's audio stage already has a volume control. Instability in the form of "howling" or "motor-boating" is less likely with the circuit of B. This form of instability is not unusual in high-gain audio circuits following a regenerative detector, especially with a loud speaker operating at fairly high volume. The trouble is partly electrical and partly acoustical in origin. Sound waves from the speaker aggravate instability by vibrating the tube of the sensitive regenerative detector circuit with the result that a micro-

phonic "howl" builds up. To prevent this trouble, the speaker should be placed and faced so that the sound is least able to affect the detector, and the volume level should be kept as low as possible. The best speaker location should be determined by trial. The audio power unit can be built up on a small base about 3 inches wide to match the particular receiver with which it is to be used. Usually the output transformer is incorporated in the speaker unit, and therefore need not be mounted in the amplifier stage.

### The "Old Reliable" Tuned R.F. Autodyne

● The progressive amateur is rarely content to operate a receiver not fitted with at least one stage of radio-frequency amplification. The increase in sensitivity and the general improvement in performance made possible by a stage of r.f. amplification is usually well worth the additional apparatus and the added construction.

The "Old Reliable" three-tube receiver illustrated, and diagrammed in Fig. 713-A, has a tuned r.f. stage with controllable sensitivity. The circuit arrangement differs a little from those previously described, but the operating principles are the same. The band-spreading system will be recognized as the first of those outlined in Fig. 603 in the previous chapter. It is used in this set because it is one of the easiest systems to get working when the tuning of two

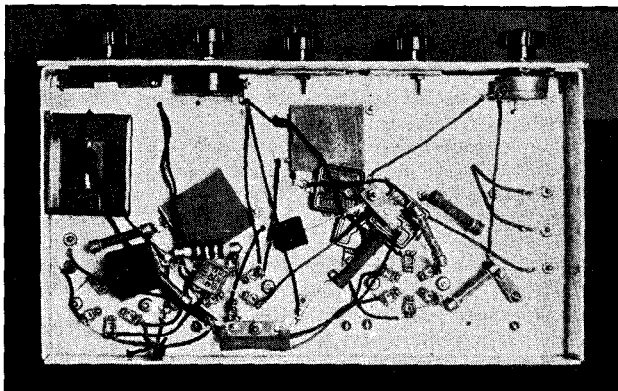

FIG. 714 — UNDER THE BASE OF THE THREE-TUBE RECEIVER Resistors, by-pass condensers, chokes; all placed where most convenient. The audio coupler is mounted on the side at the left.

# . . . . . The Construction of Receivers

stages is to be ganged, and because the relatively large capacity in the tuned circuits makes the detector oscillate more stably and thus prevents the signals from wavering should the "B" supply voltage change slightly.

The panel is of  $\frac{1}{8}$ -inch aluminum and measures 7 by 14 inches. The sub-base is made of a single piece of  $\frac{3}{32}$ -inch aluminum with the corners cut out and edges bent down in a vise so that the top surface is  $13\frac{1}{2}$  by  $7\frac{1}{2}$  inches and the vertical sides are two inches high. The two shield boxes are made of  $\frac{1}{16}$ -inch aluminum, each measuring  $4\frac{3}{4}$  inches high,  $4\frac{1}{4}$  inches wide and 7 inches deep. The panel constitutes the front of both boxes. The pieces making up the sides of the boxes are fastened together by being screwed to vertical pieces of  $\frac{1}{4}$ -inch square brass rod which have been drilled and tapped to take small machine screws at appropriate points. Similar rods also are used to fasten the boxes to the panel.

It is important, in building up the chassis, to make certain that good contact is made between all metal parts. Loose panels in the shield boxes will result not only in poor shielding but will undoubtedly be the source of many noises.

The tuning condensers are Hammarlund midgets, mounted as shown in Fig. 712. To gang the two condensers the spring contacts which wipe on the shaft should be removed so that a flexible coupling can be slipped over the shaft. The connection to the rotor plates of the con-

denser so altered should be made through the front bearing when this is done, because the rear bearing may be noisy. The condensers and dial are connected together by means of pieces of quarter-inch shafting and small flexible couplings.

The detector circuit is designed to permit the use of 5-prong coil forms. Only three terminals are needed for the oscillating circuit, the other two being available for the coupling coil from the r.f. stage. As in the shielded two-tube receiver, the tickler in this circuit comprises the portion of  $L_4$  between cathode and ground, and is smaller than the tickler of more usual regenerative circuits.

A small audio transformer is used to couple

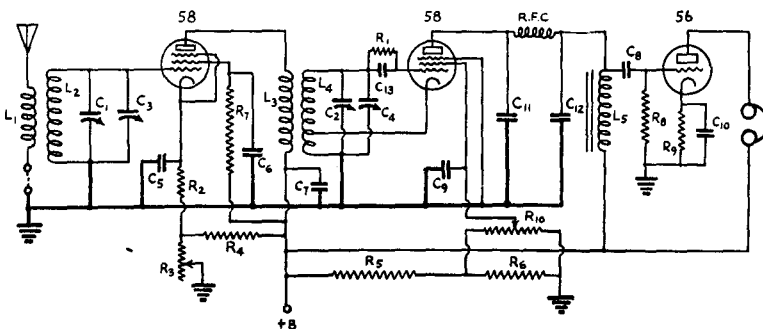

FIG. 713-A — CIRCUIT DIAGRAM OF THE "OLD RELIABLE" RECEIVER

The tube filaments (heaters) and the dial light are wired in parallel. The tubes indicated on the diagram, are for 2.5-volt a.c. operation. The 58's would be replaced by 78's or 6D6's, the 56 by a 37 or 76, and a 6-volt dial light should be used for 6-volt d.c. operation. With battery B supply resistors  $R_5$  and  $R_6$  should be omitted, and the positive terminal of the regeneration control  $R_{11}$  should be connected to the plus-45-volt battery tap; also, a d.p.s.t. switch should be included to cut off both sides of the B supply when the receiver is not in use, in addition to a switch in the filament circuit. The negative-B connection is made to the chassis (ground). Heavy lines indicate "ground" connections which should be made on the chassis. Power-pack design for a.c. operation is given in Chapter Fifteen.

- $C_{1, 2}$  — 35- $\mu$ fd. midget condensers (Hammarlund MC-35-S). See text.
- $C_{3, 4}$  — 100- $\mu$ fd. midget condensers (Hammarlund MC-100-S).
- $C_{5, 6, 7, 8}$  — .01- $\mu$ fd. mica condensers.
- $C_{9, 10}$  — 1- $\mu$ fd. non-inductive paper condensers.
- $C_{11, 12}$  — 100- $\mu$ fd. fixed mica condensers.
- $C_{13}$  — 250- $\mu$ fd. mica condenser.
- $R_1$  — 5-megohm resistor.
- $R_2$  — 250 ohms, 2 watt.
- $R_3$  — 10,000-ohm wire-wound potentiometer, tapered.
- $R_4$  — 50,000 ohms, 2 watt.
- $R_5$  — 14,000 ohms, wire-wound, 5 watt.
- $R_6$  — 5000 ohms, wire-wound, 5 watt.
- $R_7$  — 100,000 ohms, 1 watt.
- $R_8$  — 1 megohm.
- $R_9$  — 2000 ohms, 1 watt.
- $R_{10}$  — 50,000-ohm potentiometer.
- $L_5$  — 1080-henry a.f. choke (Thordarson T-2927 or equivalent.)

### Coil Data

Band	$L_1, L_2$ on same form; $L_3, L_4$ ditto.			
	$L_1$	$L_2$	$L_3$	$L_4$
1750	10	55	30	55 tapped at 3rd turn
3500	6	28	20	28 " " 1st "
7000	5	11	9	11 " " $\frac{1}{2}$ "
14,000	3	5	5	5 " " $\frac{1}{4}$ "

All primaries ( $L_1$  and  $L_3$ ) are wound with No. 36 d.s.c. wire. The 3500-kc. grid coils are wound with No. 20 d.c.c.; 1750-kc. grid coils with No. 28 d.c.c.; both close-wound. The 7000- and 14,000-kc. grid coils are wound with No. 18 enamelled wire spaced to occupy a length of  $1\frac{1}{4}$  inches. Tap turns are from the ground end of detector coils. National 5-prong coil forms (diameter  $1\frac{1}{2}$  inches) are used. Spacing between coils on each form is approximately  $\frac{1}{8}$  inch.

# The Radio Amateur's Handbook . . . . .

the detector to the audio amplifier. A coupler such as the one used in the two-tube receiver can be substituted, provided changes are made in the mechanical arrangement of the set so it can be fitted in.

The wiring diagram of Fig. 713-A is for

with the receiver. With an ordinary antenna and ground, one of the antenna posts should be connected to the ground post to complete the circuit.

Should the set not work right at the first trial, check over the wiring and apply the tests outlined elsewhere in this chapter. These tests also apply to the two-tube receivers previously described.

Noticeably weak signal response will result with an open antenna coupling coil or open connection in the antenna-ground circuit. A shorted grid condenser, either in a detector circuit or an r.f. amplifier using capacitive coupling, will have the same effect. This

may be checked by removing the grid resistor, which should cause the periodic clicking sound in the output. Shorts of this kind can be caused by a blown condenser or by soldering paste smeared between the terminals. Needless to say all soldered connections should be thoroughly wiped with a clean cloth to prevent such leakages.

A regenerative receiver may "howl" just as the detector starts to oscillate. This "fringe howl" is most likely to result with transformer or impedance-coupled detector output and the best precaution against it is to use an audio transformer or choke of the better grade rather than one of the cheaper type with inadequate primary windings. If it does occur with the transformer that must be used, however, it

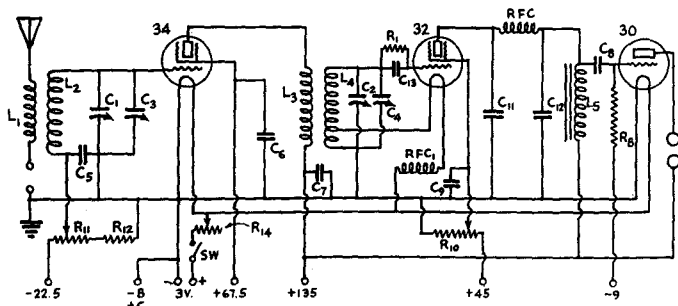

713-B — THE THREE-TUBE RECEIVER CIRCUIT MODIFIED FOR USE WITH TWO-VOLT TUBES

Components have the values given in Fig. 713-A with the following additions:  $R_{11}$ , 50,000-ohm potentiometer;  $R_{12}$ , 5000 ohms, 1-watt rating;  $R_{14}$ , 10-ohm rheostat;  $RFC_1$ , same specifications as given in Fig. 707.  $R_{11}$  and  $R_{12}$  constitute the gain control circuit in the r.f. amplifier;  $R_{12}$  is used to make certain that a small amount of grid bias will be applied to the tube even though  $R_{11}$  is set at its minimum-bias end. Filament supply may be from an Air-Cell battery or from two dry cells connected in series.

To prevent "B" and "C" battery discharge through the voltage-dividers when the receiver is not in use, switches may be installed in series with the "-22.5" and "+45".

operation from an a.c. power pack which will deliver 2.5 volts a.c. for the filaments of 58 and 56 tubes, or 6 volts d.c. for 6D6 and 76 or similar 6-volt types, with 200 volts d.c. for the plates. Voltages for the screen grids are obtained by means of voltage dividers and series resistors. If "B" batteries are to be used resistors  $R_5$  and  $R_6$  may be omitted and a separate lead brought out from  $R_{10}$  to the 45-volt tap on the "B" battery, as shown in Fig. 713-B.

Resistor  $R_3$  of Fig. 713-A, or  $R_{11}$  of Fig. 713-B, controls the amplification of the r.f. tube by varying the bias applied to its grid. The advantage of such a control is that it permits reducing the strength of strong signals and thus prevents the detector from "blocking" or "pulling in." A strong signal will occupy much more space on the dial than a weak one unless its strength can be reduced. The sensitivity control does this and thereby greatly increases the effective selectivity of the receiver.

The antenna input has been arranged so that a doublet antenna can be used

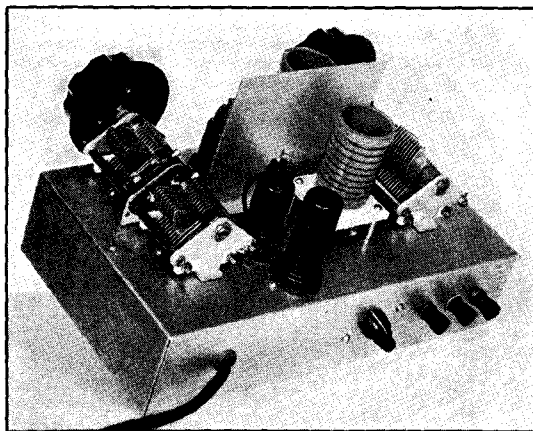

FIG. 715 — THE CHASSIS OF THE BALANCED T.R.F. REGENERATIVE RECEIVER WITH GANGED BAND-SET AND BAND-SPREAD TUNING

# The Construction of Receivers

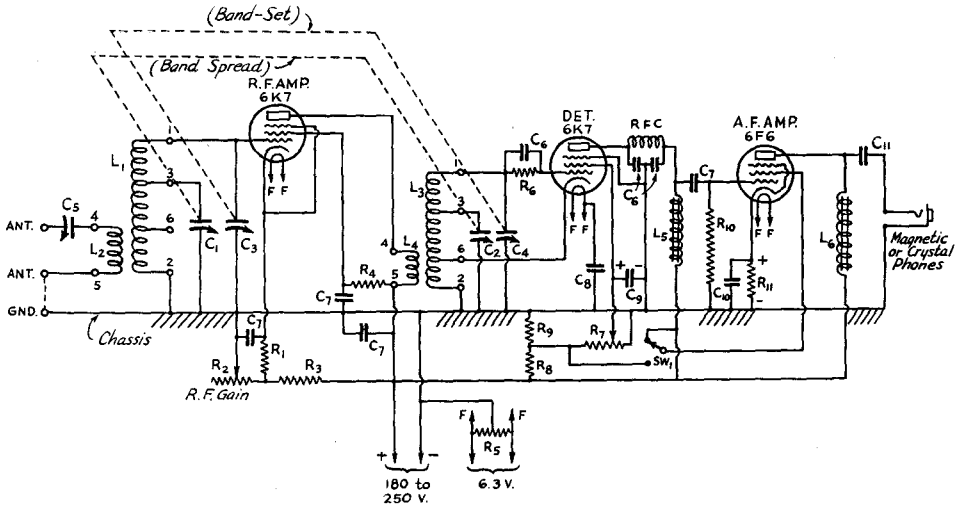

FIG. 716 — CIRCUIT OF THE BALANCED T.R.F. RECEIVER

- L<sub>1</sub> and L<sub>3</sub>* — See coil table of Fig. 708.  
*L<sub>2</sub> and L<sub>4</sub>* — Primary windings. All are close-wound with No. 36 d.s.c. wire, at bottom end of coil form. No. 1 has 20 turns; No. 2, 15 turns; No. 3, 10 turns; and No. 4, 5 turns.  
*L<sub>5</sub>* — 1080-henry detector plate coupling choke (Thor-darson T-2927).  
*L<sub>6</sub>* — Output plate choke (30-henry 50-ma.).  
*C<sub>1</sub>, C<sub>2</sub>* — Double-gang band-spread tuning, 100- $\mu$ fd. per section (National 2SE-100).  
*C<sub>3</sub>, C<sub>4</sub>* — Band-set tuning, same as above.  
*C<sub>5</sub>* — 75- $\mu$ fd. midjet antenna coupling condenser (National UM-75).  
*C<sub>6</sub>* — 100- $\mu$ fd. mica condensers.  
*C<sub>7</sub>* — 0.01- $\mu$ fd. tubular paper condensers.  
*C<sub>8</sub>* — 0.001- $\mu$ fd. r.f. by-pass condenser.  
*C<sub>9</sub>* — 1- to 4- $\mu$ fd. screen-grid by-pass (400-volt paper or electrolytic).  
*C<sub>10</sub>* — 10- $\mu$ fd. electrolytic cathode by-pass.  
*C<sub>11</sub>* — 0.5- $\mu$ fd. 400-volt output coupling condenser (paper).  
*R<sub>1</sub>* — 300-ohm  $\frac{1}{2}$ -watt cathode resistor.  
*R<sub>2</sub>* — 10,000-ohm variable resistor (r.f. gain control).  
*R<sub>3</sub>* — 50,000-ohm 2-watt bleeder.  
*R<sub>4</sub>* — 100,000-ohm  $\frac{1}{2}$ -watt screen voltage dropping resistor.  
*R<sub>5</sub>* — 75-ohm filament center tap resistor.  
*R<sub>6</sub>* — 0.5- to 5-megohm grid leak (to give desired sensitivity and smoothness of regeneration control).  
*R<sub>7</sub>* — 50,000-ohm potentiometer (regeneration control).  
*R<sub>8</sub>* — 20,000-ohm 10-watt voltage divider resistor.  
*R<sub>9</sub>* — 2500-ohm 1-watt divider resistor.  
*R<sub>10</sub>* — 0.5-megohm  $\frac{1}{2}$ -watt audio coupling resistor.  
*R<sub>11</sub>* — 400-ohm 1-watt audio cathode resistor.  
*RFC* — 2.5-mh. r.f. choke (National Type 100).  
*SW<sub>1</sub>* — S.p.d.t. toggle switch (timer control).

can be reduced or eliminated by connecting a resistor across the secondary of the audio transformer. In most cases a resistance of 100,000

ohms will be sufficiently low. A grid leak of lower value also may help in some cases. These expedients reduce the receiver output, of course, and must be considered as less desirable than the substitution of an audio coupler having better characteristics.

"Stringy quality" or poor base-note response usually can be traced to an open or inadequate bypass capacitance in a detector or audio amplifier circuit. Too-small capacitance across a cathode resistor is a common source. An open or too-small grid condenser in a grid-leak detector also may be the cause of this trouble.

## T.R.F. Receiver With Ganged Band-Spread and Band-Set Tuning

● A compact receiver chassis in which band-spread and band-set tuning is accomplished by double-gang condensers is illustrated in Fig. 715. The circuit diagram is given in Fig. 716. This particular layout is both electrically and physically balanced, making the controls symmetrical on the front. The circuit is adaptable to either the metal or equivalent glass type tubes. The tuning system uses the tapped-coil method of band-spread, as in the two-tube pentode receiver, and the coils are of the same specifications except for the primary windings. Both coils for each band are wound the same, although the cathode tap is not used on the r.f. coil. However, with the r.f. and detector coils interchangeable it is unnecessary to pick out each one separately when changing bands.

The 16-gauge plated steel chassis measures 7 by 12 inches and is 2½ inches deep. The double-gang tuning condensers are centered

2¼ inches in from each side, the band-spread gang on the left and the band-set gang on the right as viewed from the front. The coil sockets are positioned next to the band-spread gang with the band-spread tap terminals towards

limiting action, as described in the previous chapter. The reduced voltage is taken from the detector screen voltage divider, across  $R_9$ , with which the regeneration control is also in parallel. To the extreme right, as viewed from

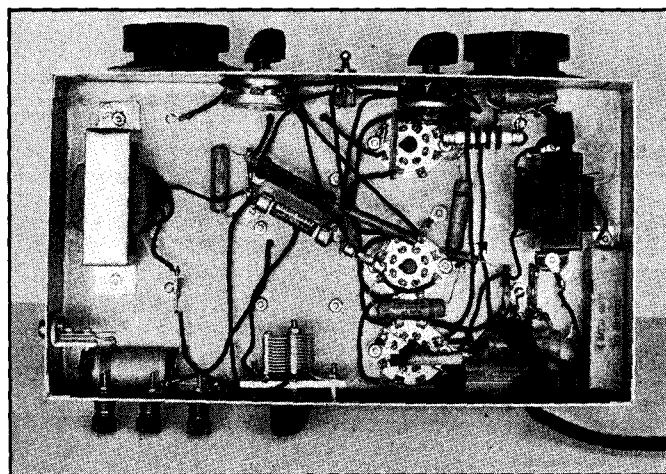

FIG. 717 — UNDERNEATH THE CHASSIS OF THE BALANCED T.R.F. REGENERATIVE RECEIVER

the condenser so as to give short leads. Grid end connections of stiff bus wire run across to the band-set condenser stator terminals. The 1/16-inch aluminum baffle shield between the two stages is 5 inches wide by 4¼ inches high, extending about 1 inch above the tops of the coil forms. The coil sockets are mounted to give approximately ¾-inch spacing between the coils and the shield.

Primary leads and the cathode feed-back lead of the detector coil run through holes in the base directly below the respective socket terminals. The tube sockets, between the coil sockets and band-set condenser gang, are sub-panel mounted with their filament terminals toward the coil sockets. This gives a short connection for the detector cathode, which is important in this regenerative circuit. The grid condenser and leak for the detector, in front of the baffle shield, are soldered directly to the bus wire running from the detector coil grid terminal to the band-set condenser. As shown in the bottom view of Fig. 717, the r.f. gain control is to the left of center and the regeneration control to the right. Between these two controls is the audio amplifier screen voltage switch. This is a single-pole double-throw toggle which changes the screen-grid voltage either to full value for maximum power output or to about 30 volts for reduced output and

the bottom, is the detector plate audio impedance and to the extreme left is the output coupling choke of the audio amplifier. The antenna and ground terminals are at the back of the chassis, as is also the antenna or "trimmer" condenser connected in series with the primary of the r.f. coil. This condenser serves to line up the input circuit to suit different antenna characteristics, usually requiring only a single adjustment for each amateur band. The audio output jack, to which either magnetic or crystal headset, or a speaker, can be connected is at the rear-left. The detector screen-grid by-pass condenser  $C_9$  is in the rear-right corner. Other components are located to give short connections.

Although no individual trimming is provided for the different coils, no trouble should be experienced in getting proper alignment. There is actually considerable tolerance in the alignment of the single r.f. stage. Adjustment of the antenna coupling condenser for "peak" performance is adequate, provided the coils are wound in exact accordance with specifications. The tuning of this receiver follows the same procedure given for the two-tube pentode set. The audio screen voltage switch will usually in the low-voltage position for headset reception, especially on c.w. telegraph. A power supply especially designed for regenerative receivers, as described in Chapter 15, must be used to prevent excessive hum. It should be capable of 60 ma. or so at 250 volts for maximum receiver output.

### Single-Signal Superhet With Regenerative I.F. Stage

● The six-tube regenerative single-signal superheterodyne shown in Figs. 718, 719 and 721 is illustrative of the design and construction of amateur high-frequency superhets. It has a preselector stage, first detector with separate oscillator, a stage of regenerative i.f., power second detector, and separate beat oscillator.

## . . . . . The Construction of Receivers

The photographs show the general arrangement and Fig. 720 gives the wiring diagram. The left-hand shield in Fig. 718 contains the high-frequency oscillator. Directly behind the drum dial is the 2A5 second detector. In the center compartment is the first detector and its tuning circuits, with the oscillator coupling condenser, while in the right-hand compartment is the r.f. preselector-amplifier.

On the back deck, at the extreme left, is the c.w. beat oscillator coil and condenser unit,  $T_3$ , with the beat control knob projecting at the top. Next is the c.w. beat oscillator tube. The center can contains the i.f. transformer assembly,  $T_2$ , with the i.f. amplifier tube to its right. At the extreme right is the regenerative i.f. transformer assembly,  $T_1$ .

Looking at the front of the panel, the upper row of knobs are, left to right: h.f. oscillator tank,  $C_5$ ; first detector tank,  $C_4$ , and r.f. tuning condenser,  $C_1$ . At the bottom of the panel, the left-hand switch,  $SW_1$ , controls the high voltage supply to the receiver. Next is the c.w. beat oscillator "on-off" switch,  $SW_2$ , cutting the screen voltage. The knob below the illuminated dial is the main tuning control operating the ganged condensers  $C_2$  and  $C_3$ , with the gain control,  $R_3$ , next. The knob at the right operates the i.f. selectivity control, the regeneration attenuator  $R_2$ .

Doublet antenna connections are made to insulated binding posts on the outside shield of the r.f. stage, with the ground binding post nearby on the main deck. With a conventional single-wire antenna connected to one insulated post, the other is connected to ground. Of course the doublet antenna should be used if possible, since it makes possible considerable additional gain.

Insulated 'phone tip jacks on the left end of the chassis provide connections for 'phones and speaker.

Once the tank condensers have been set for a given band, the selectivity adjusted to the desired degree, and the c.w. beat note fixed, the receiver is in effect single-dial tuning with operating controls for volume, frequency and c.w. note convenient for one position of the hand.

The structural part of the receiver is all of sheet aluminum. The chassis or main deck is made from a piece of 3/32-inch aluminum 21 inches by 12 inches. From two corners on one

long side of this piece, 2-inch squares are cut out and then three sides are bent down at right angles so as to form the sides and back of a deck 17 by 10 inches and 2 inches high.

All of the inter-stage box shields are cut from 1/16-inch aluminum. The six sides are 7 inches long by 4 3/4 inches high, while the three ends are 4 1/4 inches wide by 4 3/4 inches high. The shields are held together at the corners by 1/4-inch square brass rods drilled and tapped for 6/32 machine screws. The corner posts are fastened to the main deck by screws into their lower ends.

The front panel is of 1/2-inch thick aluminum, 18 inches long by 7 inches high. It is fastened by screws to the front posts of the shield boxes. A cover fitting over all the shields is a sheet of 1/16-inch aluminum 16 inches by 7 inches held in place by flat springs on its under side, pressing against the sides of the shield boxes.

The Isolantite five-prong coil sockets are mounted above-deck on pillars long enough to clear the contacts. Similar tube sockets (six-prong) are mounted below the base under their 1 1/2-inch holes. With this arrangement a minimum of wires need pass through the base. Complete tube shields are provided for all tubes. A 1/2-inch length of 1/8-inch rubber tubing slipped over each grid wire, before soldering on the grid clip and afterwards pushed up on the clip, prevents any possible grounding of the grid on the grid-cap shield.

The National 500-ke. i.f. transformers each require minor alterations to adapt them to the circuit, and they should be removed from

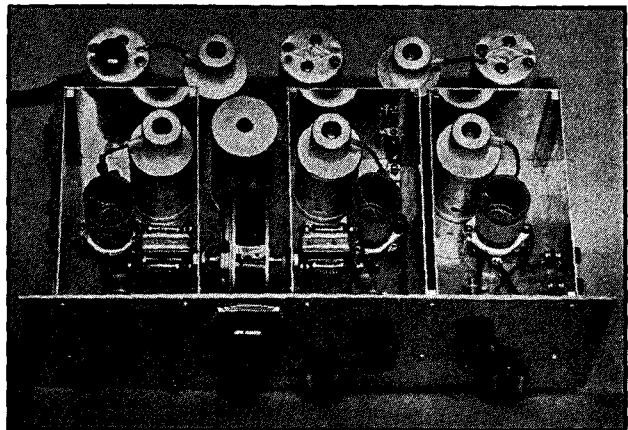
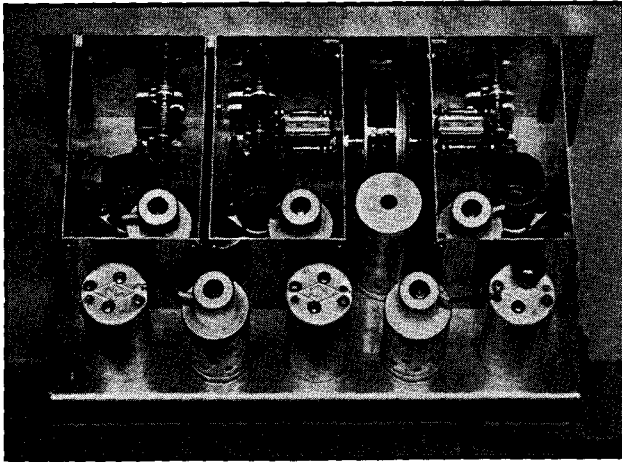

FIG. 718 — A SIX-TUBE REGENERATIVE SINGLE-SIGNAL SUPER-HETERODYNE RECEIVER

*A pre-selector stage, a separate high-frequency oscillator, and a high-gain i.f. stage with controllable regeneration make this receiver an outstanding performer. (WIEAO.)*



**FIG. 719 — A REAR VIEW OF THE REGENERATIVE SINGLE-SIGNAL SUPERHETERODYNE**

*This supplements the front view of Fig. 718 and shows more clearly the construction of the intermediate-frequency amplifier.*

their cans for this purpose. The first operation is on the regenerative i.f. transformer,  $T_1$ .

As supplied, the grid coil,  $L_7$ , is at the upper end of the dowel, nearest the condensers, and the plate coil at the bottom. In order to couple the tickler coil,  $L_8$ , to the grid coil, the external connections from the unit  $T_1$  must be changed so that the grid coil is the lower one. This means that one of the wires that normally passes out through the bottom of the can should be brought out the top through a piece of shield braid; and the wire originally at the top is brought out through the bottom.

A one-inch length of  $\frac{1}{2}$ -inch dowel is fastened by means of a wood screw to the end of the dowel carrying the coils in the unit. At the lower end of the new dowel, the tickler  $L_8$  is bunch-wound with 25 turns of No. 30 d.s.c. wire. If this tickler is wound in the same direction as the other coils, the final connections from  $T_1$  are as follows: Inside end of upper or plate coil  $L_6$  to B+, outside to first detector plate through shield braid; inside end of middle or grid coil  $L_7$  to ground, outside through shield braid from top of can to grid cap of i.f. amplifier; inside end of lower or tickler coil  $L_8$  to i.f. suppressor, outside end through shielded lead

to i.f. cathode. If the i.f. circuit cannot be made to oscillate with  $R_9$  in the maximum resistance position or disconnected, then the tickler connections should be reversed at the coil terminals. If oscillation should fail with the tickler connected either way, the number of tickler turns should be increased a few at a time until oscillation is obtainable.

For  $T_2$  the connection out of the top of the shield is removed and brought down inside to the detector grid condenser and leak which are placed within the can. Plate and grid leads from  $T_2$  also should be shielded with flexible copper braid.

In the beat oscillator unit the grid condenser and leak are also mounted within the can. The only other operation required

is to shield the grid lead from the top of the can to the oscillator tube.

The high-frequency oscillator coupling condenser  $C_7$  is made of two brass angles, having faces about  $\frac{3}{4}$  by  $\frac{3}{8}$  inch, mounted on a small piece of bakelite in the detector compartment with the faces spaced  $\frac{1}{8}$  inch. The connection from the plate of the h.f. oscillator to  $C_7$  is in shielded braid but may be left unshielded.

The coils are wound on National 5-prong forms according to specifications given in the

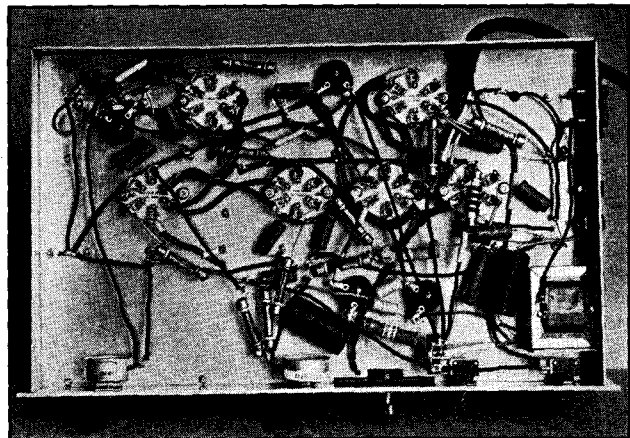

**FIG. 721 — A BOTTOM VIEW OF THE SIX-TUBE SUPERHET**

*By-pass condensers and resistors are placed in the most convenient locations. The detector output transformer is mounted on the side wall of the chassis, and can be seen in the lower right-hand corner.*



# The Construction of Receivers

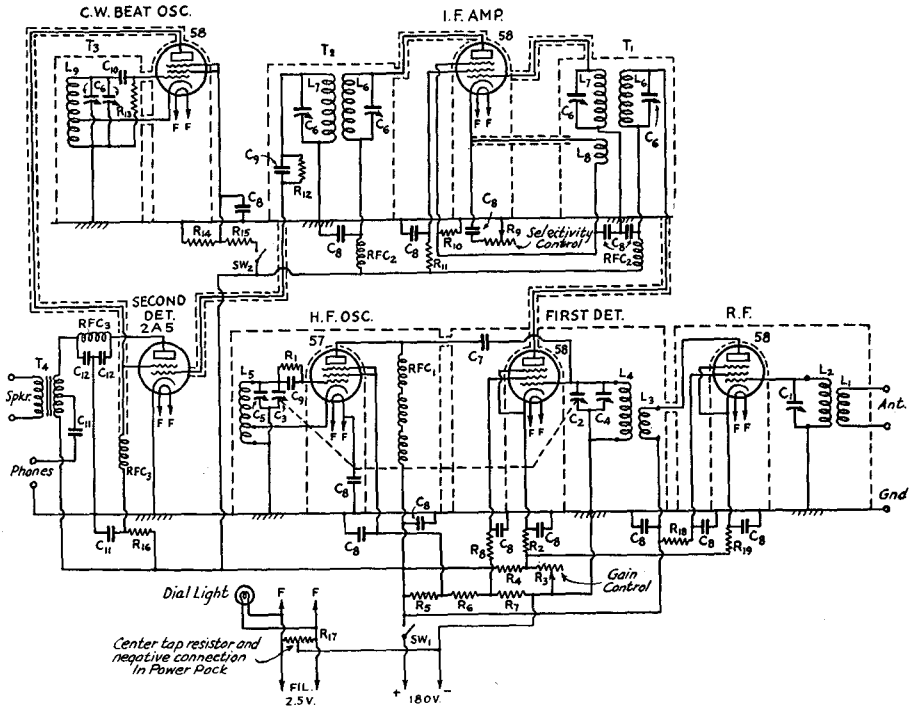

FIG. 720 — CIRCUIT OF THE SIX-TUBE REGENERATIVE S.S. RECEIVER

Dotted lines indicate shielded leads.

$L_1, L_2, L_3, L_4$  and  $L_5$  — See coil table.

$L_6$  and  $L_7$  — 500-kc. i.f. transformer windings.

$L_8$  — See text.

$L_9$  — 500-kc. beat oscillator coil. (See text.)

$C_1$  — 140- $\mu$ fd. midget condenser (Hammarlund MC-140M).

$C_2, C_3$  — 25- $\mu$ fd. midget condenser (National SE-50 cut down to 3 stator plates).

$C_4, C_5$  — 100- $\mu$ fd. midget condensers (Hammarlund MC-100M).

$C_6$  — 70- $\mu$ fd. midget condenser (in National i.f. units).

$C_7$  — H.f. oscillator coupling condenser. (See text.)

$C_8$  — 0.01- $\mu$ fd. r.f. by-pass condensers, tubular paper.

$C_9$  and  $C_{10}$  — 250- $\mu$ fd. mica grid condensers.

$C_{11}$  — 1- $\mu$ fd. audio by-pass and coupling condensers.

$C_{12}$  — 250- $\mu$ fd. plate by-pass condensers, tubular paper.

$R_1$  — 50,000-ohm 1-watt oscillator grid leak.

$R_2$  — 5,000-ohm 1-watt first detector cathode resistor. (Electrad).

$R_3$  — 12,000-ohm variable resistor, right-hand taper.

$R_4$  — 100,000-ohm 1-watt.

$R_5$  — 10,000-ohm 5-watt.

$R_6$  — 7,000-ohm 2-watt.

$R_7$  — 3,000-ohm 2-watt.

$R_8$  — 50,000-ohm 1-watt.

$R_9$  — 2,000-ohm variable resistor, left-hand taper (Electrad).

$R_{10}$  — 300-ohm 1-watt (i.f. amplifier cathode resistor).

$R_{11}$  — 50,000-ohm 1-watt.

$R_{12}$  — 1-megohm  $\frac{1}{2}$ -watt second detector grid leak.

$R_{13}$  — 50,000-ohm  $\frac{1}{2}$ -watt beat oscillator grid leak (Integral with National oscillator unit).

$R_{14}$  — 2,500-ohm 2-watt.

$R_{15}$  — 50,000-ohm 2-watt.

$R_{16}$  — 25,000-ohm 5-watt.

$R_{17}$  — 20-ohm center-tap resistor (in power supply).

$R_{18}$  — 50,000-ohm 1-watt.

$R_{19}$  — 300-ohm 1-watt r.f. cathode resistor.

$T_1$  and  $T_2$  — National 500-kc. air-tuned i.f. transformers. (See text.)

$T_3$  — National 500-kc. beat oscillator assembly.

$T_4$  — Universal push-pull output transformer (Kenyon).

$RFC_1$  —  $2\frac{1}{2}$ -mh. sectional choke (National No. 100).

$RFC_2$  — 10-mh. single-section universal wound r.f. choke.

$RFC_3$  — 60-mh. single-section universal wound r.f. choke.

$SW_1$  and  $SW_2$  — Single-pole panel switches.

table. No attempt has been made to make the tuned circuits track exactly. The over-all gain of the receiver is high enough so that, by judicious use of the gain control, c.w. reception is possible throughout an entire amateur band without touching the tank condensers. Better tracking can be secured easily by removing a

few turns of wire from the oscillator coils  $L_5$ . A further refinement would be to gang an additional condenser, similar to  $C_2$  and  $C_3$ , for the r.f. amplifier.

The power supply leads are brought in through a flexible cable in the rear. The B+ voltage is conveniently distributed from a

terminal strip attached to  $SW_2$ . Although only four wires are essential to the power supply cable, cables with four wires having two which are of suitably low resistance for heater currents are not readily available. Accordingly, a standard 8-wire cable is used with three wires in parallel for each of the heater leads. By this means the filament voltage drop from power supply to set is kept to a value of less than 0.1 volt. Care must be taken, however, that all the paralleled wires are securely soldered to the terminal plug at the supply end of the cable.

The power supply may be of the superhet type described in Chapter Fifteen. The filament winding of 2.5 volts should be capable of delivering the 8 amperes necessary for the tubes and dial light. High voltage under 50-ma. load should be approximately 180 volts.

To align the i.f. amplifier, set the selectivity control at minimum selectivity, and apply a 500-kc. signal to the grid of the i.f. tube. The second i.f. transformer is then adjusted to resonance as indicated by maximum second-detector output, an insulated socket wrench being used to tune the condensers  $C_6$  at the top of the can. The oscillator is then coupled to the first detector grid and the same procedure is used to tune the first i.f. transformer. The beat oscillator may be isolated from the second-detector circuit and used as a signal source, but preferably a separate test oscillator should be

used. If a modulated signal is used, the output can be judged by ear. For an unmodulated signal a 0-50 milliammeter should be placed in the plate circuit of the second detector, when resonance will be indicated by plate current dip to minimum.

After aligning the i.f., the high-frequency circuits are aligned, using an oscillator or frequency meter giving a signal in an amateur band. The three condensers  $C_1$ ,  $C_2$  and  $C_3$  will have nearly the same settings, although the oscillator (being tuned 500 kc. higher than the detector) will have a somewhat lower capacity setting.

**HIGH-FREQUENCY COIL DATA**

Band Kc.	$L_1$ Turns	$L_3$ Turns	$L_2, L_4$ and $L_5$ Turns	Tap on $L_5$ —Turns from Ground End
1,750	10	30	55, No. 28 d.c.c. <sup>1</sup>	18
3,500	6	20	28, No. 20 d.c.c. <sup>1</sup>	9
7,000	5	9	11, No. 18 enam. <sup>2</sup>	3
14,000	5	5	5, No. 18 enam. <sup>2</sup>	2

<sup>1</sup>Close-wound.

<sup>2</sup>Spaced to make coil length  $1\frac{1}{4}$  inches.

$L_1$  and  $L_3$  all close-wound with No. 36 d.s.c., spaced  $\frac{1}{8}$ -inch from  $L_2$  or  $L_4$ . Forms are National R-39, five-prong.

When everything is aligned the c.w. beat oscillator should be set so as to give about a

1000-cycle tone when heterodyning a signal tuned in "on the nose." Then the selectivity control should be brought up to just below oscillation, as indicated by the "ringing" sound. The signal will increase in intensity and, with tuning through zero beat, the audio image or "other side of zero beat" should be hardly audible. Careful manipulation of the alignment adjustments will bring out this desired single-signal feature to its fullest.

The value of the tickler  $L_3$  has intentionally been left so that oscillation in the i.f. circuits can occur with the control resistor  $R_9$  almost, but not quite,

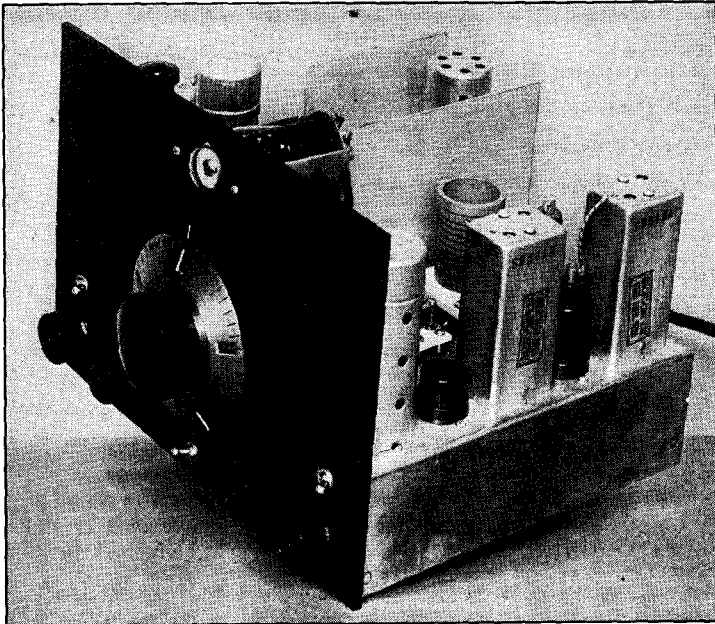

FIG. 722—GENERAL VIEW OF THE HIGH-PERFORMANCE SUPERHET

at its point of highest resistance. The receiver never should be operated with the i.f. self-oscillating.

**High-Performance Superhet With Regenerative First Detector**

● The receiver illustrated in Fig. 722 is intended to give maximum performance for the number of tubes and circuits used, while combining good mechanical stability and adaptability to amateur construction. It is also designed to accommodate a noise-silencer and crystal filter unit, as described farther on, in case the builder wishes to include all the features available in the modern single-signal type receiver. The circuit line-up, as shown in the diagram of Fig. 723, consists of a regenerative first detector (or mixer) using a 6L7 tube, a separate high-frequency oscillator using either a 6D6 glass or 6K7 metal tube, an iron-core transformer coupled i.f. stage using a 6L7 with dual automatic gain control, a 6H6 duodiode second detector and a.v.c. rectifier, a 6D6 or 6K7 i.f. beat oscillator, a 76 or 6C5 triode first audio stage and a 42 or 6F6 pentode output amplifier. There is also a 6E5 "Magic Eye" tuning indicator tube which, while not essential to operation of the receiver circuit proper, is an extremely useful adjunct. The receiver operates from a separate power supply, such as the heavy-duty type described in Chapter 15, which must be capable of at least 2.8 amperes at 6.3 volts for the filaments and 90 ma. at 250 volts d.c.

The oscillator-mixer circuit is similar to that shown in Fig. 616 of the previous chapter, the injector (No. 3) grid of the 6L7 being capacitively coupled to the cathode of the oscillator. This circuit shows negligible "pulling" effect as the result of mixer input tuning up through the 14-mc. band, and only slight effect at 28 mc., provided the coils are properly adjusted. The single-control tuning system employs the tapped-coil method of band-spreading and tracking with adjustable air condensers for

setting the range. Regeneration in the mixer input circuit is obtained by a cathode circuit feedback coil coupled to the grid coil, regeneration being controlled by a variable resistor acting as a r.f. shunt across this tickler winding. This method of control is the same as that used in the regenerative i.f. amplifier of the previous receiver. It maintains the electrode voltages constant, in contrast with screen voltage control as used in regenerative autodyne detectors, and has but slight effect on the mixer tuning, even at the higher frequencies.

Only two points need be mentioned in connection with the i.f. amplifier circuit. The No. 3 grid of the 6L7 is connected in parallel with No. 1 for d.c., but not for r.f., and a voltage divider instead of a simple series resistor is used for obtaining screen voltage. As shown in the diagram, the No. 3 grid is returned to the ground side of the i.f. transformer secondary, where it picks up the a.v.c. voltage along with the No. 1 grid. The rather heavy screen voltage divider maintains the screen at practically constant potential despite the bias applied to the grids, thus increasing the effectiveness of both the manual and automatic gain controls. The manual gain control is bled off the plate supply by the usual method.

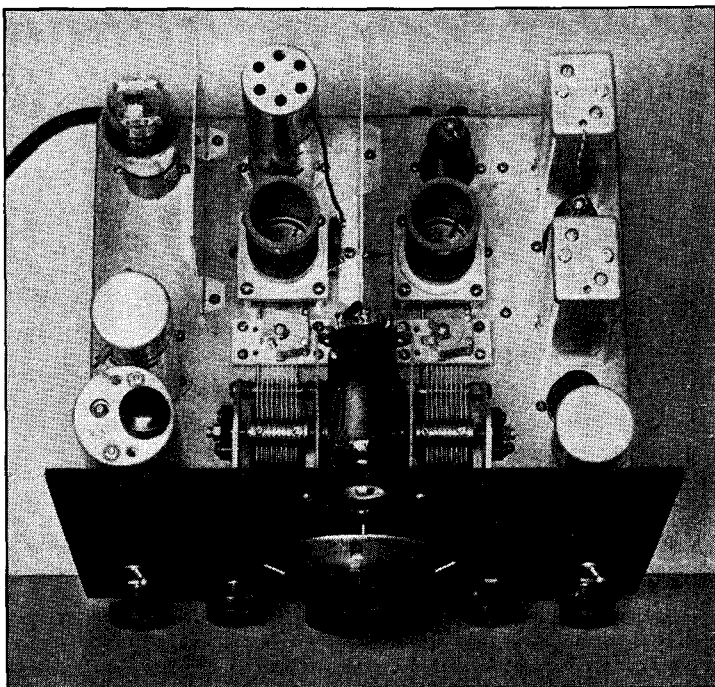

FIG. 724 — TOP VIEW OF THE HIGH-PERFORMANCE SUPERHET, SHOWING THE LAYOUT OF THE COMPONENTS

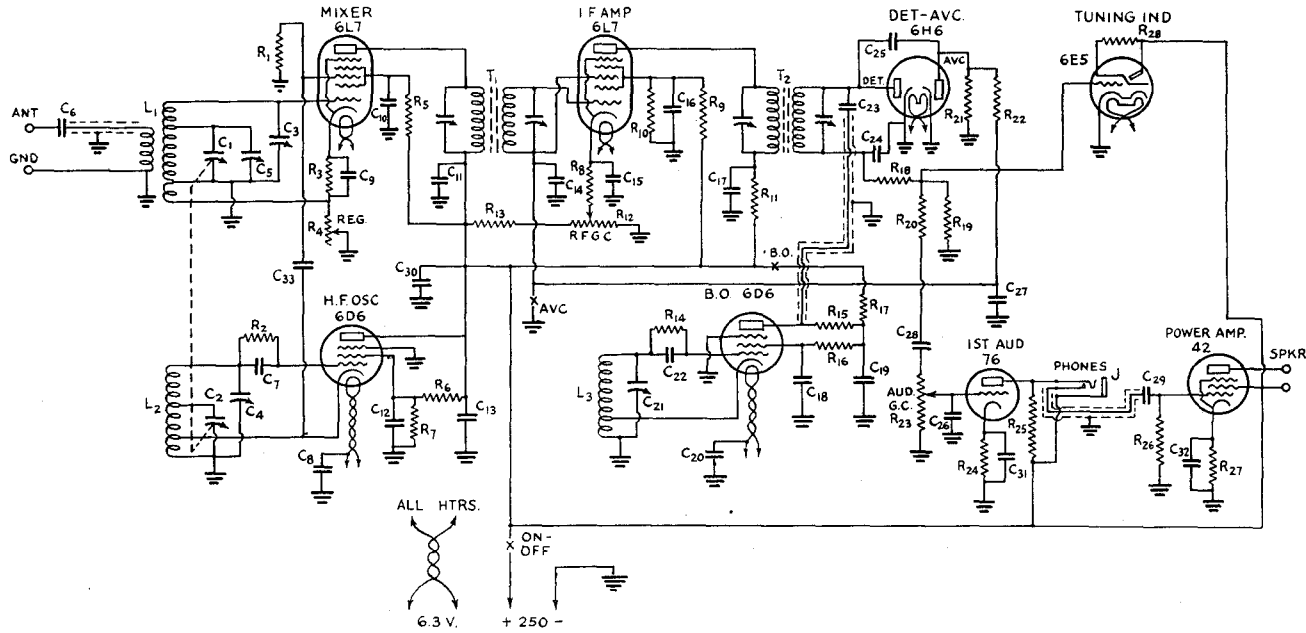

FIG. 723 — THE HIGH-PERFORMANCE SUPERHET CIRCUIT DIAGRAM. SHELL PIN TERMINALS OF METAL TUBES ARE ALL GROUNDED TO THE CHASSIS

- C<sub>1</sub>, C<sub>2</sub> — Ganged condensers, 160- $\mu$ fd. each (National type PW tuning unit).
- C<sub>3</sub>, C<sub>4</sub> — 50- $\mu$ fd. air trimmers (National type UM-50).
- C<sub>5</sub> — 25- $\mu$ fd. midget variable (Hammarlund MC-25-S).
- C<sub>6</sub> — 50- $\mu$ fd. midget mica condenser.
- C<sub>7</sub> — 100- $\mu$ fd. midget mica condenser.
- C<sub>8</sub> — 0.002- $\mu$ fd. mica condenser.
- C<sub>9</sub> — C<sub>20</sub>, inc. — 0.01- $\mu$ fd. paper condensers, non-inductive.
- C<sub>21</sub> — 140- $\mu$ fd. variable (in B.O. unit).
- C<sub>22</sub> — 250- $\mu$ fd. mica condenser (in B.O. unit).
- C<sub>23</sub> — B.O. coupling condenser, about 5  $\mu$ fd. (see text).
- C<sub>24</sub>, C<sub>25</sub>, C<sub>26</sub> — 100- $\mu$ fd. mica condensers.
- C<sub>27</sub>, C<sub>28</sub>, C<sub>29</sub> — 0.1- $\mu$ fd. paper condensers.
- C<sub>30</sub> — 0.5- $\mu$ fd. paper condenser.
- C<sub>31</sub> — 5- $\mu$ fd., 25-volt electrolytic.

- C<sub>32</sub> — 25- $\mu$ fd., 25-volt electrolytic.
- C<sub>33</sub> — 50- $\mu$ fd. fixed mica condenser.
- R<sub>1</sub>, R<sub>2</sub> — 50,000 ohms, 1/2 watt.
- R<sub>3</sub> — 500 ohms, 1/2 watt.
- R<sub>4</sub> — 2000-ohm variable (Centralab 72-101).
- R<sub>5</sub> — 15,000 ohms, 1 watt.
- R<sub>6</sub> — 50,000 ohms, 1 watt.
- R<sub>7</sub> — 50,000 ohms, 1/2 watt.
- R<sub>8</sub> — 300 ohms, 1/2 watt.
- R<sub>9</sub> — 10,000 ohms, 10 watt.
- R<sub>10</sub> — 15,000 ohms, 1 watt.
- R<sub>11</sub> — 2000 ohms, 1/2 watt.
- R<sub>12</sub> — 5000-ohm variable (Centralab 72-110).
- R<sub>13</sub> — 50,000 ohms, 1 watt.
- R<sub>14</sub> — 50,000 ohms, 1/2 watt (in B.O. unit).
- R<sub>15</sub> — 10,000 ohms, 1 watt.
- R<sub>16</sub> — 100,000 ohms, 1/2 watt.
- R<sub>17</sub> — 50,000 ohms, 1 watt.
- R<sub>18</sub> — 50,000 ohms, 1/2 watt.
- R<sub>19</sub> — 500,000 ohms, 1/2 watt.

- R<sub>20</sub> — 100,000 ohms, 1/2 watt.
  - R<sub>21</sub>, R<sub>22</sub> — 1 megohm, 1/2 watt.
  - R<sub>23</sub> — 1-megohm variable (Centralab 72-116).
  - R<sub>24</sub> — 2000 ohms, 1/2 watt.
  - R<sub>25</sub> — 50,000 ohms, 1/2 watt.
  - R<sub>26</sub> — 1 megohm, 1/2 watt.
  - R<sub>27</sub> — 450 ohms, 2 watt.
  - R<sub>28</sub> — 1 megohm, 1/2 watt.
  - T<sub>1</sub> — Air-tuned iron-core i.f. transformer for coupling 6L7 converter to 6L7 amplifier (Aladdin S-2242-A).
  - T<sub>2</sub> — Air-tuned iron-core i.f. transformer for coupling 6L7 amplifier to diode rectifier (Aladdin S-2242-B).
  - L<sub>1</sub>, L<sub>2</sub> — See coil table.
  - L<sub>3</sub> — Beat-oscillator coil, 465 kc. (in B.O. unit).
  - J — Double-circuit jack.
- All switches single-pole single-throw.

One section of the 6H6 is used for detection and the other for obtaining a.v.c. voltage. Since the a.v.c. action is limited, it was not found necessary to bias the a.v.c. diode to give delay. There is practically no reduction in

signal strength on weak signals when the a.v.c. is switched in. The i.f. beat oscillator operates at low plate voltage and is very loosely coupled to the detector. A weak b.o. signal is favorable for the

# . . . . . The Construction of Receivers

reception of weak signals, tends to limit the beat response on strong ones, and permits using the a.v.c. for c.w. reception. This is helpful in holding down the loud signals when tuning over a band.

The diode load circuit consists of the resistors  $R_{18}$  and  $R_{19}$  in series.  $R_{18}$  serves as an r.f. attenuator, backed up by  $R_{20}$  for further attenuation.  $C_{26}$ , across the 76 grid, is a further aid to keeping r.f. out of the audio circuits and gives some tone-control action to reduce noises of high audio frequency.

The grid of the 6E5 tuning indicator is connected to the audio-diode load rather than to the a.v.c. line. This method of connection permits using the tube as a strength indicator on c.w. signals, since the shadow movement is instantaneous.

The audio circuits require no particular comment. The gain is such that a 'phone signal whose carrier barely moves the tuning indicator will give good loud-speaker strength. Headphone signals are rather more than comfortable level with the audio gain wide open. If a "rattling the diaphragms" signal is wanted, the 'phones could be connected in the pentode output through a suitable transformer or choke.

The cadmium-plated steel chassis of the receiver is 12 inches by 10 inches by 3 inches deep. As shown in the bottom view of the set, half-inch L-girder strips of aluminum run front to back and across the center under the r.f. circuits to stiffen the chassis and thereby improve the electrical stability. A heavier type of chassis than the kind ordinarily available could be used to good advantage, since mechanical rigidity is of utmost importance in obtaining good electrical stability. Mechanical stability is also aided by the National PW tuning unit, and by the four-corner mounting coil sockets. The tuned circuit wiring is stiff No. 14 tinned solid copper, except for the grid connectors. Even these should be given attention, especially that of the oscillator. If a glass oscillator tube (6D6) is used, a rubber grommet should be provided to support the grid lead where it passes through the tube shield. Otherwise, slight jarring will cause appreciable jumping of the oscillator frequency as the result of this lead shifting position. It should be mentioned that hum modulation noticeable with glass tube oscillators (6D6's), especially on 28 mc., is eliminated with a metal tube oscillator (6K7). The latter is therefore generally preferable.

The arrangement of the receiver can be followed quite readily from Figs. 724 and 726. Referring to the top view, the tuning-condenser

assembly is centrally mounted, the oscillator condenser being that at the left and the mixer at the right. The air trimmers,  $C_3$  and  $C_4$ , are directly behind the tuning condensers, followed

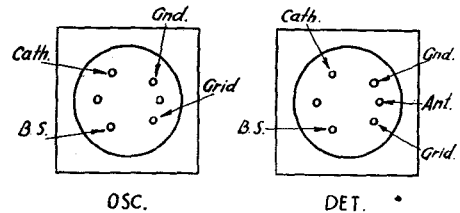

FIG. 725 — THE HIGH-PERFORMANCE SUPER-HET'S COIL SOCKET CONNECTIONS AS VIEWED FROM THE TOP

in each case by the coil sockets and finally by the tubes. The coil and socket pin arrangement is shown in Fig. 725. This arrangement becomes of some importance at the higher frequencies if the receiver and coils are to be duplicated, since the lead lengths have their influence on the coil design. A baffle shield measuring  $4\frac{1}{2}$  inches high by 6 inches long runs down the center of the chassis from the dial gear box to the rear edge, shielding the oscillator and mixer circuits from each other. A similar baffle,  $4\frac{1}{2}$  by  $4\frac{1}{2}$  inches, encloses the oscillator on the other side. This shielding seems to be sufficient to prevent coupling between the two tuned circuits, since the mixer tuning has absolutely no effect on the oscillator frequency when  $C_{33}$  is disconnected from the oscillator cathode.

Connections from the condenser rotors and from the ground ends of the coils should be made to the chassis with the shortest possible leads. In this case we also have ground leads through the tuned circuit paralleling the chassis grounds to insure good conductivity. *But the short, direct grounds to the chassis itself are of prime importance if the set is to be stable in operation*, especially with regeneration on the mixer.

Wiring for the oscillator and mixer circuits occupies the rear center section of the chassis, as shown in the bottom view. The parts are simply wired in so that short connections can be made, using insulating soldering-lug strips wherever necessary. The antenna-ground post assembly is mounted on the back near the mixer socket, with a shielded lead running through a hole in the chassis to the antenna post on the coil socket.

The regeneration control resistor,  $R_4$ , is mounted on a home-made bracket near the back of the chassis. A flexible coupling and a piece of  $\frac{1}{4}$ -inch round brass rod bring the control out to the front panel. The bracket

should be made so that the resistor shaft will line up with the panel hole when ready for mounting. A bearing, actually the sleeve portion of a discarded 'phone jack, keeps the extension shaft in place on the panel and helps

In the bottom view, the audio volume control is at the extreme left. It is the right-hand control in the right-side-up views, and is mounted on the front of the chassis directly below the audio tube socket. A shielded lead runs from the plate of the 76 along the left-hand bracing girder to the back of the chassis, thence to the right along the rear edge to the 'phone jack. The shield is grounded at several points to prevent r.f. pickup.

Under each i.f. transformer is a chassis hole about the size of a tube-socket hole to allow plenty of room for bringing out leads. Close bunching of leads is undesirable.

The left-hand section of the chassis (top view) contains, in order from front to back, the beat-oscillator transformer, b.o. tube and power output tube. These parts are at the right in the bottom view. The control in the corner is the r.f. gain control — the only rotating control, incidentally, whose position is not critical with respect to length of connecting leads.

The National beat-oscillator transformer used in the receiver is furnished complete with tuning condenser, grid condenser and grid leak, so that it is only necessary to connect the tube and supply the plate circuit resistors and condensers. If the oscillator circuit is made up from different parts, the values given in Fig. 723 will be satisfactory. The lead from the plate of the b.o. tube runs in shielded wire — grounded at several points — to the diode detector plate, coupled through a small condenser mounted right on the appropriate tube-socket prong. This condenser is a home-made affair consisting of two thin brass plates, separated about a sixteenth inch, the facing areas being about a half-inch square. It was made by removing the center lug from an insulating strip having three lugs, then soldering one brass plate to each of the remaining lugs, on opposite sides of the strip. The size is not critical, but the capacity should be small both to keep down the beat-oscillator signal and to avoid adding any appreciable shunt capacity to the diode circuit.

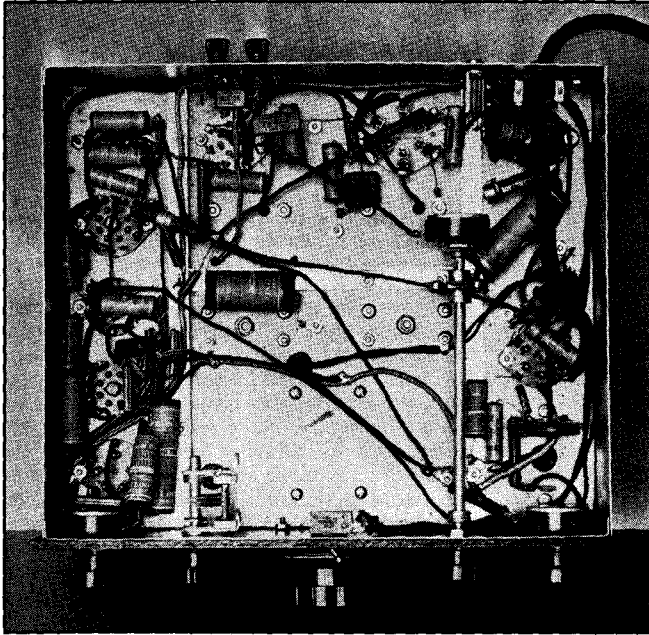

FIG. 726 — UNDERNEATH THE HIGH-PERFORMANCE SUPER'S CHASSIS

*Resistors and by-pass condensers are placed to give short, direct connections. Other components are located as described in the text.*

make the control smooth-turning. It was necessary to mount the regeneration control in the position shown so that the r.f. trimmer,  $C_5$ , could be mounted close to  $C_1$ , and thus make possible a short stator connection between the two. The lead from the mixer cathode to  $R_4$  is therefore comparatively long, but no particular harm results from having it so.

The first i.f. transformer is in the rear right corner of the chassis. Progressing toward the front, next in line is the 6L7 i.f. amplifier tube, second i.f. transformer, 6H6 duo-diode rectifier, and 76 audio tube, the latter being in a shield. Sub-chassis wiring, shown to the left in the bottom view, is again simply a matter of fitting in a considerable number of small parts so that short leads are possible. Ground leads once more should be short and directly to the chassis. The use of midget tubular paper by-passes and the new-type insulated resistors simplifies the space and insulation problems.

# . . . . . The Construction of Receivers

The output tube is mounted in the rear corner of the chassis rather than being centered, chiefly to keep it as far as possible from the oscillator coil. The shield between the oscillator circuit and the 42 is more of a baffle for heat than electrostatic shield.

The cathode-ray tuning indicator is mounted on home-made brackets of brass strip so that the top of the tube projects slightly through the panel. The 1-meg. resistor is mounted right on the socket, and the necessary leads are twisted into a cable and carried down through the chassis on the detector side of the central baffle shield. The length of these leads does not matter particularly. Be sure to mount the tube with the target side downward (heater pins to the right when viewed from the top) so that the shadow will be at the bottom where it is most easily seen.

The three switches are mounted as follows: At left in panel view, beat oscillator on-off switch; below the tuning dial, B cutoff switch; at right, a.v.c. on-off switch.

One last point in wiring — keep the filament wires in the corners of the chassis; this is a help in preventing hum.

When the wiring has been completed and checked, the i.f. circuits should be aligned before the mixer and oscillator coils are given final adjustment. The intermediate circuits should be tuned exactly to the right frequency, 465 kc., since the tracking of the oscillator and first detector circuits depends on the intermediate frequency. This is best done with a test oscillator of the type described in Chapter Seventeen. To line up the i.f., clip the oscillator leads on ground and the 6L7 mixer grid — with the coils out of their sockets — set the oscillator to 465 kc., and adjust the trimmers to give maximum deflection of the 6E5. If the "eye" closes entirely, decrease the test oscillator output or reduce the r.f. gain control so that a definite maximum point can be passed through on each trimmer.

If no test oscillator is available, the c.w. beat oscillator can be used for the purpose. To set the b.o. on the proper frequency, connect a wire to its plate and bring it near the lead-in to a broadcast receiver. Tune the latter to 930 kc. and adjust the beat oscillator until its second harmonic is at zero beat with the station heard. This should be fairly easy, since 930 seems to be a rather popular channel. Then couple the b.o. output to the grid of the mixer — simply taking a turn around the grid cap should be enough — connect the grid to ground through a resistor of a megohm or so, and line up as already described.

The i.f. should show no tendency to oscillate with all circuits at resonance, provided the shells of the metal tubes are grounded. The last remnant of instability can be cleared up by installing  $C_{30}$ , which is a main by-pass across all plate supply circuits.

If the i.f. and a.f. amplifiers are properly constructed and adjusted, the receiver should be perfectly stable with the r.f. and a.f. gain controls wide open. With a good power pack, there should likewise be a complete absence of hum.

In winding the coils, make the 14-mc. set first. This is usually the hardest set to get lined up properly, and it is also the easiest set to duplicate from specifications. Follow the mechanical layout of the oscillator and detector circuits, particularly spacing between condensers and coil sockets so the lead lengths will be about the same as in the original

receiver. Wind the 20-meter coils *exactly* as given in the table. Plug in the coils, set the regeneration control at the zero position (resistance all out), and set  $C_5$  at half capacity. Set the tuning dial at about 250, couple on the antenna and tune  $C_4$  carefully until amateur signals are heard. Make a final adjustment to  $C_4$  to bring the low frequency end of the band at about 100 on the tuning dial. It is not advisable to go lower than 100 because the tuning starts to crowd at the maximum end of

HIGH-PERFORMANCE SUPERHET COIL TABLE

Band	Oscillator, $L_2$			Mixer, $L_1$			
	Total Turns	Cath. Tap	B.S. Tap	Total Turns	B.S. Tap	Cath. Coil Turns	Ant. Coil Turns
28 mc.	3.0	1.0	0.25	3.3	0.25	0.8	2
14 mc.	8.3	2.8	1.5	8.3	1.5	0.8	3
7 mc.	16.8	4.8	4.0	16.8	4.0	0.4	4
3.5 mc.	29.3	8.8	11.5	29.3	12.5	0.5	9
1.75 mc.	50.3	17.8	23.5	55.3	30.5	0.5	12

Oscillator coils are space-wound to occupy a length of  $1\frac{1}{2}$  inches, on  $1\frac{1}{2}$ -inch diameter forms. Mixer coils are space-wound to occupy a length of  $1\frac{1}{4}$  inches, on similar forms, except 1.75-mc. coil which is close-wound. Wire is No. 24 d.s.c. The cathode coil on  $L_1$  is wound in the opposite direction to the grid coil, starting from the ground end of the grid coil. It is very closely coupled to the grid coil. Antenna coils are close-wound, spaced about  $\frac{1}{4}$  inch from grid coil at ground end.

Specifications are given to the nearest tenth of a turn. The tenths can be measured off quite accurately by making a paper scale equal in length to the circumference of the coil form and dividing it into ten equal parts. Spacing between turns should be adjusted to be as uniform as possible, and the turns doped in place after the coil is finished. Coil forms are National 6-prong, with corresponding coil sockets.

the condenser scale. This tendency can be avoided by using trimmers of about 40- $\mu$ fd. capacity across each tuning condenser, but was not deemed worth while in view of the excellent mechanical band-spread available and the extra cost involved. With the low-frequency

and diagrammed in Fig. 728. It will be noted that this circuit is practically the same as that of Fig. 629 of the preceding chapter, to which the reader should refer for an explanation of the principles of operation. The 6L7 is an extra i.f. amplifier tube, preceding the crystal filter; the silencing voltage is applied to its No. 3 injection grid. The 6J7 and 6H6 are the noise amplifier and rectifier. Silencing, therefore, takes place before the signal reaches the crystal, thereby preventing shock excitation of the crystal by the noise voltages.

The paralleled control grids of the 6L7 and 6J7 pick up their i.f. exciting voltages from the grid cap which normally goes to the i.f. tube in the receiver. After passing through the unit, the i.f. signal goes to the grid of the receiver i.f. tube.

The electrode voltages on the 6L7 i.f. amplifier-noise-silencing tube are adjusted primarily to give most effective noise silencing and not particularly to give additional i.f. gain. Nevertheless, there is some gain; rough measurement shows that the stage gives an amplification of two, approximately. The value of the cathode resistor,  $R_1$ , as well as those of the resistors in the screen voltage divider,  $R_2$  and  $R_3$ , are chosen to put a few volts of bias on the control grid and about 30 or 40 volts on the screen; this to make the No. 3 grid, to which the silencing voltage is applied, give more effective control than is possible with normal bias and screen voltages.

The primary of the crystal input transformer,  $T_1$ , connected in the plate circuit of the 6L7, is untuned. The particular transformer used has its secondary tuned by an air trimmer of the usual type; to get the balanced circuit needed for the crystal filter, and also to provide a selectivity control, a split-stator condenser,  $C_1$ , is connected across the secondary circuit.  $C_2$  is the phasing condenser or rejection control. The crystal output transformer,  $T_2$ , is a single-winding affair, also air-tuned, tapped to give a suitable match for the crystal impedance. The tap is coupled to the crystal through a 50- $\mu$ fd. fixed condenser. This condenser may be made variable, if desired, to give fine adjustment of the coupling between the crystal and output transformer, although the fixed condenser usually will be found satisfactory. The ground terminal of  $T_2$  is indicated in the diagram as going to the a.v.c. line in the receiver. In case the unit is applied to another type of receiver which does not have a.v.c., this lead can be connected directly to the chassis, in which case  $C_{11}$  may be omitted.

In the silencer circuit, the 6J7 noise amplifier is biased for normal operation, but its cathode is connected to the rotor arm of a variable

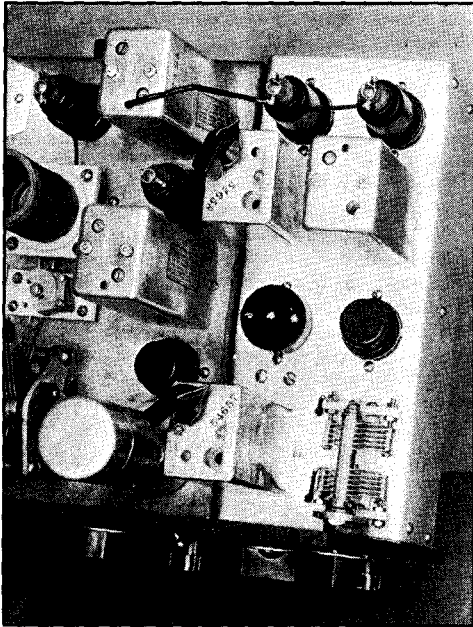

FIG. 727 — THE CRYSTAL FILTER AND NOISE-SILENCER UNIT ATTACHED TO THE HIGH-PERFORMANCE SUPER

*The unit bolts to the right-hand side of the receiver chassis. No receiver wiring changes are necessary. The various components are identified in the text.*

end at 100, the high-frequency end should fall between 350 and 400.

When the trimmers are properly adjusted, they should be marked so that they can be returned to the same settings at any time. The correct settings will be found to be somewhere in the vicinity of half capacity.

With the 14-mc. range in working order, the other coils must be wound to fit the trimmer settings just found. Some slight modification of the specifications given may be necessary, but they should work out quite closely with reasonable care in duplication. For further details, refer to the description in April 1936 *QST*.

#### A Noise-Silencer and Crystal Filter Unit

● A noise-silencer and crystal filter unit especially designed for the "High-Performance" receiver, and also adaptable to other receivers using one or two i.f. stages, is illustrated in Fig. 727



# . . . . . The Construction of Receivers

resistor,  $R_8$ , so that the bias applied to its grid can be varied between a minimum of three volts (resulting from the use of the cathode resistor  $R_5$ ) and a maximum of about 20 volts.  $R_8$ , by setting the point at which the noise circuit starts to operate, acts as a threshold control. The cathode of the 6H6 noise rectifier also is connected to the movable arm of  $R_8$  to bias the diode plates so that rectification will not take place until the incoming signal or noise reaches the desired level. The switch  $Sw_2$  opens the cathode circuits of both tubes to disable the noise-silencing circuit when desired.

Only the primary of the diode input transformer is tuned. Its secondary is center-tapped so that the diode can be used as a full-wave rectifier. This helps prevent r.f. from getting into the line to the No. 3 grid of the 6L7, where it might upset the action of the silencer. Additional filtering is provided by  $C_3$ ,  $C_4$ , and  $RFC$ .

The chassis is made of aluminum, 4 inches wide, 10 inches deep and 3 inches high, to line up with the receiver chassis. The layout permits getting quite short leads from the first i.f. transformer in the receiver and back again into the grid of the i.f. amplifier tube.

Looking at the top view, the crystal filter occupies the left-hand section and the noise silencer the right, with the exception of  $C_1$ , the selectivity control. The 6L7 is in the left rear corner. In front of it is the output transformer,  $T_2$ , then the crystal socket, and finally, right at the front, the input transformer,  $T_1$ . While this makes a fairly long plate lead from the 6L7 to the input transformer necessary, it is better to have the plate lead long rather than one of the grid leads. The plate lead is run through shield braid to prevent coupling to the other wiring. On the right-hand side, the 6J7 is at the rear right, next is the diode transformer  $T_3$ , next the 6H6, and finally  $C_1$ , the crystal selectivity control.

By-pass condensers underneath the chassis are placed so that short connections to the chassis can be made. The phasing condenser,  $C_2$ , is mounted below deck by one of the brackets furnished for that purpose. An insulating coupling between the condenser rotor and an extension shaft (this shaft, complete with bearing, is a Bud Type 531 sawed off to fit) brings the control out to the front. A condenser with

an insulating mounting is essential, since neither side of  $C_2$  can be grounded. The crystal on-off switch,  $Sw_1$ , is simply a piece of thin brass cut so that when  $C_2$  is set at minimum its rotary plates touch the brass and short-circuit the crystal. The "switch" is mounted on a spare hole in the isolantite mounting plate of the condenser.

The r.f. choke in the silencing circuit is mounted on the side of the chassis near the 6H6 socket. The whole unit is fastened to the receiver chassis with machine screws; a hole through both furnishes an inlet for filament, B plus, and a.v.c. leads. These are soldered to

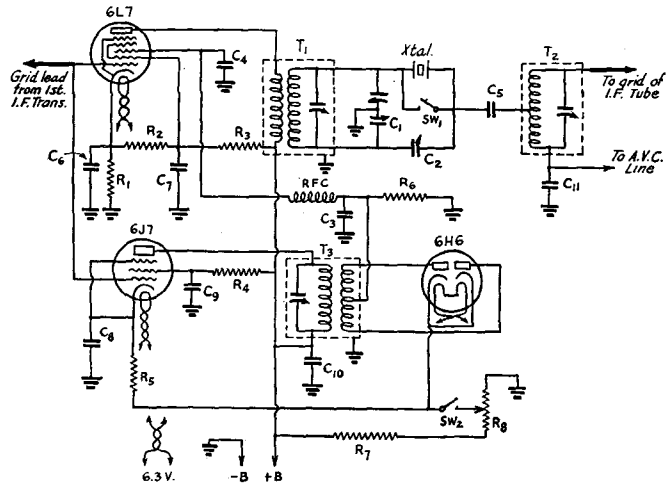

**FIG. 728 — CIRCUIT DIAGRAM OF THE CRYSTAL FILTER AND NOISE-SILENCER UNIT**

The only r.f. connection disturbed in the receiver is the grid-cap connection to the i.f. tube.

$C_1$  — Split-stator condenser (selectivity control), 50  $\mu$ fd. per section (National STD-50).

$C_2$  — 15- $\mu$ fd. variable (phasing condenser) (National UM-15).

$C_3$  — 100- $\mu$ fd. mica.

$C_4$ ,  $C_5$  — 50- $\mu$ fd. mica.

$C_8$  to  $C_{10}$ , inc. — 0.1 paper.

$C_{11}$  — 0.01 paper.

$R_1$  — 2000 ohms, 1/2 watt.

$R_2$  — 50,000 ohms, 1 watt.

$R_3$ ,  $R_4$  — 100,000 ohms, 1 watt.

$R_5$  — 300 ohms, 1/2 watt.

$R_6$  — 100,000 ohms, 1/2 watt.

$R_7$  — 30,000 ohms, 2 watt.

$R_8$  — 3,000-ohm wire-wound volume control (noise-silencer threshold control) (Yasley).

$RFC$  — 20 millihenry r.f. choke (Sickles).

$T_1$  — Crystal filter input transformer, 465 kc. (Sickles).

$T_2$  — Crystal filter output autotransformer, 465 kc. (Sickles).

$T_3$  — Diode transformer for noise circuit, 465 kc. (Aladdin).

$Sw_1$  — S.p.s.t. switch; see text for description.

$Sw_2$  — S.p.s.t. toggle switch mounted on  $R_8$ .

$XTAL$  — Bliley BC-3, 465 kc.

convenient corresponding leads in the receiver itself; their length is unimportant.

When the wiring of the silencer-filter unit and attachment to the other receiver circuits has been completed, the next step is to align

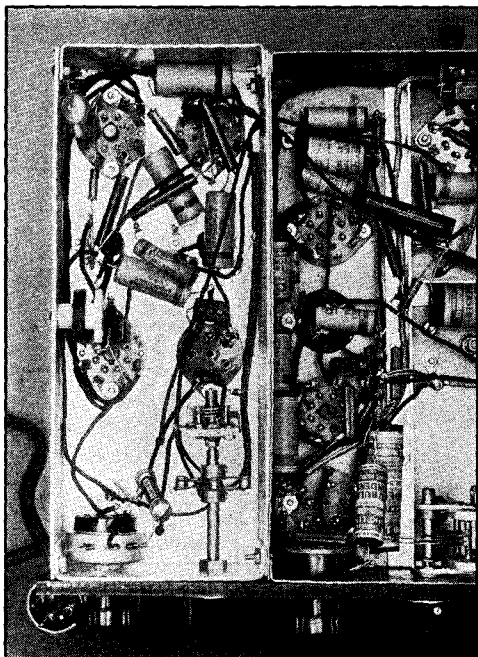

FIG. 729 — SUB-BASE WIRING OF THE FILTER-SILENCER

*In most cases, parts are simply placed in convenient locations, using short r.f. leads. The d.c. and filament supply connections to the receiver go through the grommet in the side of the unit.*

the i.f. circuits to the crystal frequency (465 kc.). The i.f. circuit can be first aligned using the crystal in a separate test oscillator circuit as shown in Chapter 17. During this process the silencer threshold adjustment should be in the "off" position. If the i.f. circuit has been aligned previously, using a 465-kc. test oscillator, it is not entirely necessary to use the crystal in a separate oscillator circuit and an alternative procedure can be followed. The first step is to find the main peak of the crystal.

Remove the grid cap from the first detector in the receiver and connect the appropriate leads from the test oscillator. Using headphones, with the beat oscillator off,  $Sw_2$  open and  $Sw_1$  open, vary the oscillator frequency slowly while listening closely for the characteristic "plop" or chirp as the oscillator frequency goes through a crystal peak. If more than one peak shows up (usually there are

more than one, but not closer than seven or eight, kilocycles to the main peak), it will be necessary to go through the tuning procedure on each in order to determine which is the main peak. The principal one will give the greatest response.

With the test oscillator peaked on the crystal frequency, tune all circuits for maximum deflection of the 6E5. It may be necessary to back off the r.f. gain as the circuits come into line, to keep the deflection within the right operating range. Readjust the test oscillator occasionally to keep the frequency on the crystal peak. To adjust  $T_1$ , set  $C_1$  near maximum capacity and line up with the trimmer in  $T_1$ . When the selectivity control,  $C_1$ , is set to give maximum response with the crystal "in," the 6E5 deflection should be the same with  $Sw_1$  either closed or open; in other words, *switching in the crystal does not cause a decrease in pure c.w. signal strength*, although the QRM and background noise are greatly reduced.

It should be remembered that the grid caps for the 6L7 and 6J7 are connected to the grid lead coming from the first i.f. transformer in the receiver. The extra capacity of the two grids in parallel will require retuning of the secondary winding of the i.f. transformer in the receiver to bring the circuit back to resonance.

To adjust the noise silencer, close  $Sw_2$  and advance  $R_3$  to about four-fifths maximum. Again using the test oscillator, adjust the condenser in  $T_3$  to block off the signal. The point at which blocking occurs will depend upon the signal strength and the setting of  $R_3$ ; use a signal which will deflect the 6E5 to about half scale and keep retarding  $R_3$  until the signal just blocks off when  $T_3$  is tuned to resonance. The blocking is very easily seen on the "eye." With a local noise source the adjustment of  $T_3$  can be made equally well without a signal — possibly better — by adjusting for greatest noise suppression.

If no test oscillator is available, a strong incoming signal may be used for lining-up purposes. It should, however, be perfectly steady. A local broadcast harmonic or signal from the freq-meter-monitor is best.

In operation, with the crystal switch,  $Sw_1$ , closed (this occurs with the phasing condenser,  $C_2$ , set at minimum, as already described), the crystal is cut out of the circuit and the receiver is simply a "straight" superhet.  $C_1$  should in that case be set for maximum signal strength. With the switch open, and  $C_1$  set at the same point, the selectivity is greatly increased and the signal strength unchanged. Tune in a signal to maximum strength, using the 6E5 as an indicator, and set the beat os-

# • • • • • *The Construction of Receivers*

illator to the desired pitch. Tune the main dial to the same pitch on the other side of zero beat, without touching anything else. This "other side" will be quite weak compared to the right setting. Now vary  $C_2$  slowly until the beat note disappears, or reaches a very low minimum. This process eliminates the audio-frequency image and is an important setting in obtaining maximum c.w. selectivity. The selectivity can be further increased by tuning  $C_1$  down in capacity from the resonance setting; maximum selectivity will be found with  $C_1$  considerably on the high-frequency side of i.f. resonance. At maximum selectivity ( $C_1$  all out) some decrease in signal strength results, although when the going is really tough the decrease is unimportant compared with the possibility of pulling the signal out of QRM. Should a strong interfering signal still cause trouble, it can often be pushed out of the picture by careful adjustment of  $C_2$ , which moves the point of maximum rejection over a small frequency range. For tuning across the band, and for most communication, the selectivity will be sufficient with  $C_1$  set for optimum selectivity — at or slightly higher than resonance — and with  $C_2$  set for rejection of the a.f. image.

The action of the silencer in taking out strong noise peaks of the auto-ignition type, plus the selectivity of the crystal in reducing noise of the more "solid" type, makes it possible to copy weak signals through a noise background which completely masks them with the ordinary superhet arrangement. Further details are given in the article describing this unit in Oct. 1936 *QST*.

## **Servicing Superheterodyne Receivers**

● In addition to the general receiver servicing suggestions already given, there are a few others for troubles peculiar to superhet type receivers. Generally poor performance, characterized by broad tuning and poor sensitivity, calls for checking of the circuit tuning and alignment as previously described. The procedure is to start with the receiver output (audio) and work back through the second detector i.f., and high-frequency circuits, in the order named.

In case of oscillation in high-frequency amplifier and first detector circuits, as evidenced by squeals or "birdies" with varying of their tuning, look for poor connections in the common ground circuits, especially to the tuning condenser rotors. Inadequate or defective bypass condensers in cathode, plate and screen grid circuits also can cause such oscillation. In some cases it may be advisable to provide a baffle shield between the stators of pre-r.f. amplifier and first detector ganged tuning con-

densers, in addition to the usual tube and inter-stage shielding. A metal tube with an ungrounded shell will cause this trouble. Improper screen-grid voltage, as might result with a shorted or too-low screen-grid series resistor, also could be responsible.

Oscillation in the i.f. circuits, independent of high-frequency tuning and indicated by a continuous squeal when the gain is advanced with the c.w. beat oscillator on, will result from similar defects in i.f. amplifier circuits. Inadequate cathode resistor bypass capacitance is a very common cause of such oscillation. Additional bypass capacitance, 0.1 to 0.25  $\mu\text{fd.}$ , usually will remedy this type of oscillation. The same applies to screen-grid bypasses of i.f. tubes.

"Birdies" and "mush" occurring with tuning of the high-frequency oscillator may indicate that it is "squegging" or oscillating simultaneously at high and low frequencies. This may be caused by a defective tube, too-high oscillator plate or screen-grid voltage, excessive feed-back in the oscillator circuit or excessive gridleak resistance. If the latter, replace with a new resistor, using one of lower resistance if necessary.

Excessive "hiss" may be caused by a defective h.f. or i.f. tube, by an open grid circuit, or by misalignment of high-frequency or i.f. circuits. It may be helpful in some cases to reduce the oscillator screen voltage, in the case of an electron-coupled oscillator, or the plate voltage in the case of a triode. The same symptoms and remedies apply to the c.w. beat oscillator and its coupling to the second detector. There should be some increase in hiss when the latter is switched on, of course, as a result of the i.f. noise components beating with the carrier it furnishes in the second detector. The oscillator input to the second detector should be just enough to cause a noticeable change in second detector plate current. (About 0.05 ma. increase in the case of a self-biased triode second detector, for instance.)

High-frequency harmonics from the c.w. beat oscillator will show up as steady "carriers" which tune in like signals. These can be identified by disconnecting the antenna. If they remain the same with antenna on or off, they are almost certainly traceable to the beat oscillator. They are not likely to occur with the circuits shown in the receivers of this chapter, and are prevented by the design precautions which have been given. Other "birdies" which show up in the operation of the receiver are most likely to result from image interference. An image beat with an on-tune signal can be identified in two ways: First, it will seem to tune twice as fast as a proper signal; that is,

the beat note will go through the audible range with about half as much tuning dial movement. Second, with a single-signal receiver an image will "peak" on the opposite side of zero beat to the side on which normal signals peak as the receiver is tuned. The last method gives positive image identification with the receiver's beat oscillator on.

If a receiver equipped with a.v.c. blocks on moderately strong signals when the a.v.c. is supposed to be on, check to make certain that it is in operation. If a separate a.v.c. tube is used, check to see that it has not burned out or failed otherwise. If motorboating occurs with a.v.c., a defective tube, open load resistor or leaky bypass condenser may be at fault. Insufficient time constant (too-small bypass capacitance) and inadequate r.f. filtering in the a.v.c. feed circuits also can cause this trouble. On excessively strong signals, sufficient to drive the grid of a controlled tube positive, the same effect is likely where a.v.c. is applied to only 1 or 2 stages. It is not probable with the full-range a.v.c. available in the better type receivers.

A similar motorboating effect may occur with high-selectivity receivers, especially where a crystal filter is used. It is most noticeable with a.v.c. in operation. Its source is principally instability in the high-frequency oscillator. Slight changes in plate supply voltage cause the i.f. signal to fluctuate in and out of i.f. resonance as the consequence of this instability. The changes in supply voltage, in turn, are caused by variation in load on the supply with variation of plate current on the stages having a.v.c. applied — so that the oscillator frequency "hunts" about the proper value which would keep the intermediate frequency constant on resonance. This trouble can be eliminated by improving the voltage regulation of the supply and the stability of the oscillator.

### Judging Receiver Performance

● While complete quantitative information on the characteristics of a superhet would require a number of measurements with laboratory equipment, a qualitative estimate of relative sensitivity, stability and band-spread can be made without special means. These rough checks may be used for comparison of receivers in purchasing manufactured models, or in arguments concerning amateur-built types.

**Sensitivity:** The limiting factor determining the effective sensitivity of a receiver is its own noise ratio. For a given degree of selectivity (band width) this is determined by the gain in

the first circuit. With the antenna disconnected, a rough check on this gain can be made by shorting the first tuned circuit of the receiver through a large capacitance, leaving the other circuits unaffected, and noting the variation in noise output on a rectifier-type voltmeter connected across the output terminals. The c.w. beat oscillator should be switched on to furnish a carrier in the second detector of a superhet, gain should be full-on and a.v.c. should be switched off. The noise output should decrease with detuning, showing that the first circuit has appreciable impedance as evidenced by thermal agitation voltage. If it does not decrease, the gain of this circuit is negligible. This test should be made on each frequency band. Little change is likely on 14 mc., but should become appreciable on 3.5 and 1.7 mc. The test should be made on r.f. amplifier and detector stages. Unchanged noise output with the first detector (mixer) input shorted would indicate that the first detector tube is the principal source of noise and that there is little gain ahead of it.

**Stability:** With the beat oscillator on and a steady signal tuned in, vary the manual r.f. gain control rapidly. This will affect the oscillator plate supply voltage, as a result of varying r.f. stage plate current load. The beat note should vary but a few hundred cycles. Alternatively, a "Variac" can be connected in the a.c. supply circuit and the line supply voltage varied approximately 10 percent plus and minus normal (say from 100 to 130 volts). The beat note should remain similarly steady. A change of a kilocycle or more would indicate poor stability. Another check can be made for temperature stability by noting the change in beat note for a quarter-hour or so after "cold start" of the receiver. Mechanical stability can be checked by jarring the receiver and pushing against its panel and the sides of its cabinet, noting the shift in c.w. beat note.

**Band-Spread:** Band-spread on each amateur band can be judged by the tuning rate and the calibration spread. Tuning rate is the average number of kilocycles covered with each rotation of the tuning knob, while calibration spread is the average number of kilocycles represented by each of the smallest tuning scale divisions. Tuning rate of approximately 50 kilocycles per knob rotation is generally satisfactory in high-selectivity s.s. receivers, assuming a knob of "natural" size (approximately 2-inch diameter). Calibration spread of 10 kc. or less per scale division is satisfactory for reset and logging purposes.



# ***Principles of Transmitter Design and Operation***

## **OSCILLATORS — AMPLIFIERS — NEUTRALIZATION AND TUNING — FREQUENCY MULTIPLICATION — TROUBLE SHOOTING**

**P**RESENT-DAY amateur transmitters are of two general types: those which employ "self-controlled" oscillators and those in which a crystal-controlled oscillator is used. The first of these types is called "self-controlled" because the frequency of the oscillations generated in the transmitter depends on the constants of the circuit. In the second type a piezo-electric crystal determines the frequency on which the transmitter operates.

When an oscillator of either type is used to feed the antenna directly, the transmitter is said to be "self-excited." If, however, the oscillator drives one or more amplifier tubes which in turn feed the antenna, the arrangement is known as an "oscillator-amplifier" transmitter. One may have either a self-controlled or a crystal-controlled oscillator-amplifier transmitter.

### **Transmitting Tubes**

● An excellent variety of power tubes is available to the amateur contemplating the construction of a high-frequency transmitter. The large number of tubes is, in fact, often a source of confusion to the beginner because it is difficult for him to decide upon the type best suited to his particular purpose. Broadly speaking, tubes may be classified according to the power output to be expected from them. Thus, a group of small tubes for use in low-power transmitters shows outputs of the order of 10 to 25 watts; a group of medium-power tubes is rated at 35 to 50 watts output; a third group carries a nominal rating of 100 watts, and so on. Obviously, then, the first decision the amateur has to make in the choice of a transmitting tube is that of the power output he wants. The tables of transmitting tubes in Chapter Five give the important characteristics and operating ratings of the tubes most suitable for use as radio-frequency oscillators and power amplifiers.

The tubes are listed in two classifications, triodes or three-element tubes comprising the first. These are useful as oscillators or power amplifiers. All are capable of working well on the four lower-frequency amateur bands which carry the bulk of amateur communication — the 1.75-, 3.5-, 7- and 14-mc. bands. The types marked with an asterisk (\*) are especially designed for very high frequency work, and in addition to giving excellent performance on the four bands just mentioned, also will be found to be well suited to work on 28 and 56 megacycles.

The tetrodes and pentodes listed in the second classification are intended particularly to be used as radio-frequency power amplifiers. They are of the screen-grid type and can be used without neutralization (see later section). They are also useful in certain types of oscillator circuits.

In addition to the tubes designed especially for transmitting, practically all of the power-amplifier type receiving tubes have been adapted by amateurs to use in transmitters. Popular types include the 45, 46, 59, 47, 2A5, 53 and 6L6. The pentodes are widely used as crystal-oscillator tubes, while both triodes and pentodes are in general use as buffers and doublers, and even as final stages in low-power transmitters. With plate voltages of about 400, all these tubes are capable of outputs of five or ten watts.

### ***Self-Controlled Oscillator Circuits***

● There are two general divisions of self-controlled oscillator circuits; those employing capacitive coupling to feed back energy from the plate to the grid circuit, and those using inductive coupling for the same purpose. All circuits are modifications of these two general classes. The operation of the vacuum tube as an oscillator has been explained in Chapter Five.

# The Radio Amateur's Handbook . . . . .

The maximum amplitude to which oscillations will build up depends upon the characteristics of the tube, the circuit constants, the grid bias and the plate voltage. The frequency of oscillation will be determined principally by

Hartley, Armstrong or tuned-grid tuned-plate, Colpitts and ultraudion. They are shown schematically in Fig. 801.

## The Hartley Oscillator

● In the Hartley oscillator, shown in Fig. 801, the tuned circuit has its ends connected to the grid and plate of the tube. The filament circuit of the tube is connected to the coil at a point between the grid end and the plate end. In this way the coil is divided into two sections, one in the grid circuit and one in the plate circuit. Oscillations are maintained because of the inductive coupling between these two sections.

The frequency of oscillation is determined chiefly by the constants of the tank circuit,  $L_1C_1$ . It is influenced to some extent, however, by the interelectrode capacities of the tube, which are connected across the tank. The amount of feedback or grid excitation is adjusted by moving the tap on  $L_1$ ; as the tap is moved nearer the plate end of  $L_1$  the excitation increases. With most tubes the proper setting for the tap will be found to be with half to two-thirds the number of turns on  $L_1$  included between the tap and the plate end.

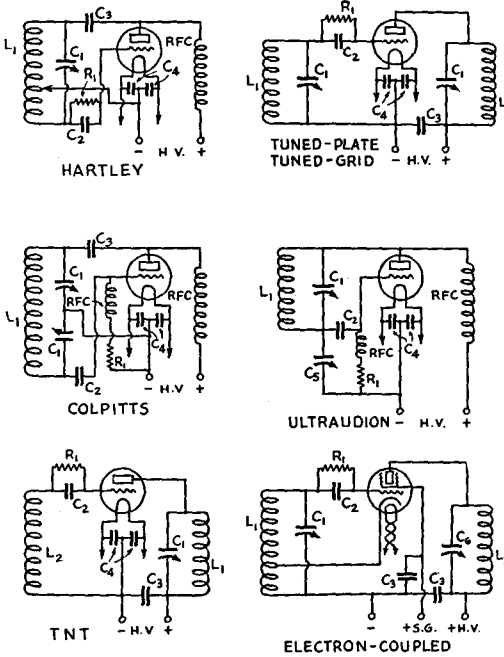

FIG. 801 — SELF-CONTROLLED OSCILLATOR CIRCUITS

All are capable of giving good frequency stability and efficiency with careful design and adjustment. For the benefit of the experimenter, the following suggestions are given for circuit constants:  $L_1$ ,  $C_1$ , depending upon frequency band to be used; consult coil table for inductances, using a 500- $\mu$ fd. condenser at  $C_1$ . The grid condenser,  $C_2$ , may be from 100 to 250  $\mu$ fd. in all circuits; its value is not generally critical. The plate blocking condenser,  $C_3$ , should be .002  $\mu$ fd. or larger. Filament bypass condensers,  $C_4$ , may be .002  $\mu$ fd. or larger. For value of grid leak,  $R_1$ , consult tube table in Chapter Five. In the ultraudion circuit the excitation control condenser,  $C_5$ , should have a maximum capacity of 100 to 250  $\mu$ fd. The output tank circuit,  $L_3$ ,  $C_6$ , in the electron coupled circuit should be designed for low-C operation; use a 250- or 100- $\mu$ fd. condenser for  $C_6$  and corresponding inductance from the coil table for the frequency in use.

In the circuits using parallel feed, the r.f. choke coils shown should not be omitted.

the inductance and capacity values in the tuned circuit — called the “tank” circuit because it acts as a reservoir of radio-frequency energy — although other circuit constants such as the interelectrode capacitances of the tube also will affect the frequency.

The circuits in most general use are the

## Blocking and Bypass Condenser Functions

● The plate blocking condenser,  $C_3$ , is used to provide a low-impedance path for r.f. currents while preventing the d.c. plate voltage from being short-circuited to the filament center-tap through  $L_1$ . Its value is not critical.  $C_2$ , the grid condenser, similarly insulates the grid from filament center-tap to permit the bias voltage to develop in the grid leak,  $R_1$ . The filament by-pass condensers,  $C_4$ , are used to provide an r.f. center-tap for the filament so that radio-frequency currents flowing in that circuit will divide equally between the two halves of the filament. Grid and plate blocking or bypass condensers and filament bypass condensers have the same general function in all the oscillator circuits shown, as well as in the amplifier circuits to be discussed later.

## Tuned-Plate Tuned-Grid and “TNT” Oscillators

● The tuned-grid tuned-plate circuit has two tank circuits, one connected between the grid and the filament of the tube and the other between the plate and filament. These two circuits are not coupled inductively, the grid-plate capacity of the tube being utilized to provide the coupling between the grid and plate circuits.

The grid and plate tank circuits of the t.p.t.g. oscillator are tuned approximately, but not exactly, to the same frequency. The frequency

# Principles of Transmitter Design and Operation

of oscillation is controlled chiefly by the constants of the plate tank circuit. The chief function of the grid tank is that of controlling the feed-back or excitation, although its tuning does have some effect on the frequency. It should be set to a slightly lower frequency than the plate tank in normal operation.

A variant of the t.p.t.g. circuit is the so-called "TNT" circuit, also shown in Fig. 801. In the TNT, the grid tank is replaced by a coil which, with its own distributed capacity plus the capacity of tube and wiring connected across it, is broadly resonant at the operating frequency. The chief advantages of the TNT are its economy and the fact that it is a very simple circuit to tune once the proper size for the grid coil has been determined.

## Colpitts and Ultraudion

● The Colpitts circuit is arranged so that the filament is connected to the junction of two condensers which are in series across the coil. In this way the grid and plate circuits share the voltage drop across the condensers.

Excitation with the Colpitts circuit is controlled by varying the capacity ratio of the two tuning condensers, the total capacity of the two in series being maintained constant to retain the same frequency of oscillation. The larger the capacity of the condenser between grid and filament compared to that between grid and plate, the lower is the excitation voltage, and vice versa. With most tubes the "grid" condenser will have about twice the capacity of the "plate" condenser for normal operation.

The ultraudion circuit, a member of the Colpitts group, is seldom used except at the ultra-high frequencies. Excitation is controlled by  $C_5$ ; the larger the capacity of  $C_5$ , the lower the excitation. The division of r.f. voltage across the tube elements is secured through the interelectrode capacities of the tube and the method of connecting the tank circuit.

## The Electron-Coupled Circuit

● The electron-coupled circuit is a development from the fundamental circuits already discussed, made possible by the screen-grid tube. This circuit gives in one tube some of the beneficial effects of the oscillator-amplifier arrangement. The control-grid, cathode and screen-grid, the latter being used as a plate, are combined in a conventional triode oscillating circuit with the screen at ground potential for r.f. voltage. The output of the oscillator is taken from the regular plate through a separate tank circuit. With a well-screened tube the coupling between the "oscillator" and

"output" portions is almost entirely through the electron stream so that capacity effects are absent. The Hartley circuit is used in the oscillator portion of the circuit shown in Fig. 801, although the Colpitts could be substituted if desired. Excitation is controlled in the same way as in the ordinary Hartley circuit.

With suitable care in design and operation, electron-coupled oscillators will provide a high order of frequency stability. The plate or output circuit may be tuned to a harmonic of the oscillator circuit as well as to the same frequency. The output usually drops off rapidly on harmonics above the second, however.

## "Grounds" and Ground Potential

● Throughout this chapter reference frequently will be made to "ground" or the "grounded" part of the circuit. In many instances this does not mean that an actual ground connection is necessary, but simply refers to the part of the circuit which is at the same radio-frequency potential as the earth, and which therefore *could* be connected to earth without in any way disturbing the operation of the circuit. The "grounded" part of the circuit nearly always will be the part which is connected to the negative terminal of the high-voltage power supply. Parts of the circuit at ground potential usually are connected together by direct wire connections or through bypass condensers, the latter being used when the two parts so connected are at the same r.f. potential but have different d.c. or a.c. voltages on them. For instance, the condenser  $C_3$  in the electron-coupled circuit of Fig. 801 connects the end of the tank coil opposite the plate to the filament center-tap, thus bringing the lower end of the tank coil to the same r.f. potential as the screen and negative side of the power supply.

## Oscillator Bias

● If the rectified grid current is made to flow through a resistor connected in the d.c. circuit between grid and filament, there will be a voltage drop in the resistor which can be utilized as grid bias, since the direction of current flow is such that the end of the resistor or grid leak nearest the grid is negative with respect to the end connected to the filament. The bias voltage developed in the grid leak will be equal to the product of the leak resistance in ohms by the d.c. grid current in amperes. If the grid current through a 5000-ohm leak is 10 milliamperes, for example, the bias will be  $5000 \times 0.010$ , or 50 volts.

The bias on an oscillator is a function of the excitation and grid-leak resistance. Oscillator

bias is self-regulating, adjusting itself to meet varying conditions of excitation. In general, grid leak values are not critical. A resistance of 10,000 ohms is suitable for most tubes working as self-controlled oscillators, although tubes having very low amplification factors may require 25,000 or 50,000 ohms, while tubes with very high  $\mu$ 's may operate best with values of 5000 ohms or lower.

### Series and Parallel Feed

● In the Hartley oscillator circuit of Fig. 801, the positive d.c. plate voltage lead is shown connected to the plate through a radio-frequency choke coil, *RFC*. The tank circuit is then connected to the plate through the blocking condenser, *C<sub>3</sub>*. This method of supplying d.c. power to the plate is known as "parallel feed" because the r.f. and d.c. plate-filament circuits are in parallel. Parallel feed requires the use of an r.f. choke having high impedance at the operating frequency so that none of the r.f. power generated by the tube can leak back to the power supply instead of going to the tank circuit where it belongs.

D.c. plate power for the t.p.t.g. oscillator is shown fed through the plate tank coil to the plate, a bypass condenser, *C<sub>3</sub>*, being connected across the positive and negative high-voltage terminals. The d.c. and r.f. plate circuits are

thus in series, and this method of supplying d.c. power to the tube is known as "series feed." With parallel feed, the plate power is fed in at a point of high r.f. potential; with series feed, the feed point is at low r.f. potential.

Series feed is usually to be preferred from the standpoint of circuit efficiency because it is not necessary to depend upon an r.f. choke to prevent leakage. With an effective choke, however, there will be negligible loss with parallel feed. With series plate feed, the shaft of the plate tank condenser usually is at d.c. plate potential above ground so that with high plate voltages there is an element of danger to the operator of the transmitter unless the condenser shaft is adequately insulated from the control knob. With parallel feed there is no d.c. voltage on the condenser shaft.

Series and parallel feed may be used in other circuits than the plate as well. For example, the grid bias for the t.p.t.g. circuit is series fed, while the grid bias for the Colpitts circuit is parallel fed. In some cases series feed may be quite difficult, if not impossible, to attain. This is the case of the grid feed for the Colpitts circuit; the grid leak cannot be connected across the grid condenser to give series feed because there is no d.c. path from the grid condenser to filament.

### Frequency Stability

● The frequency stability of an oscillator — that is, its ability to adhere closely to the desired frequency — is of primary importance. A wobbly, creeping, unstable signal is not effective for communication purposes, because of the great difficulty which a receiving operator has in keeping it tuned in. Such a signal advertises to the world that the owner of the transmitter does not have the ability to adjust his transmitter properly — or that he is indifferent about his results, since the principles of correct transmitter adjustment are not difficult to understand or apply. A steady, clean signal of low power will be more easily read than one of high power with unsteady, swinging characteristics; hence, it is important to know how instability can arise and the steps to be taken to prevent it.

The causes of frequency instability can be roughly divided into two groups, those which are "mechanical" in nature and those which are "dynamic." Mechanical instability results from variations in the circuit constants due to mechanical vibration and thermal effects. Mechanical vibration will cause rapid fluctuations in frequency by varying the spacing between condenser plates, the separation between coil turns or the distance between the

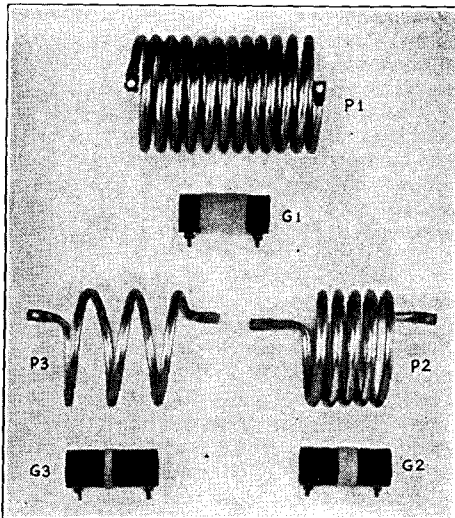

FIG. 802 — TYPICAL HIGH-C COILS FOR THE SELF-CONTROLLED OSCILLATOR

The copper-tubing coils, *P<sub>1</sub>*, *P<sub>2</sub>* and *P<sub>3</sub>*, are for the 3.5-, 7- and 14-mc. bands, respectively. They will be satisfactory for any of the circuits shown in Fig. 801. The smaller coils are of the type often used for the resonant grid coil in TNT oscillators.



# Principles of Transmitter Design and Operation

tube elements. These are avoided largely by rigid construction, by reducing the vibration and by mechanically isolating the oscillator.

Frequency fluctuation ("creeping") due to thermal effects results from variation in spacing of the tube elements (variation in interelement capacity) or circuit components with changes in temperature. Creeping can be minimized by keeping the power dissipated in the tube at or below its normal rating, by choosing tubes having internal construction particularly intended to reduce frequency-creeping (low internal capacities), and by using circuits which have large capacities in parallel with the tube's input and output capacities. Such circuits are popularly known as "High-C" circuits. The use of a large shunting capacity in the plate circuit is particularly effective.

"Dynamic" instability is caused by anything which affects the tube's characteristics, especially its average plate impedance, during operation. A variation in average plate impedance will cause a change in frequency. The principal cause of dynamic frequency instability — sometimes called "frequency flutter" — is the variation in plate voltage which results when a poorly-filtered plate supply is used. The variations in plate voltage under these conditions take place at an audible rate, causing the oscillator frequency to vary or be modulated at the same rate.

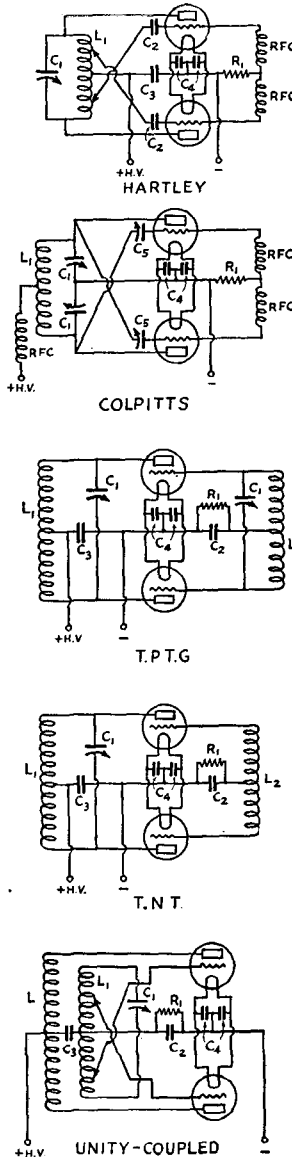

FIG. 803 — PUSH-PULL SELF-CONTROLLED OSCILLATOR CIRCUITS

Circuit constants are much the same as those for the single-tube circuits given in Fig. 301. Tank tuning condensers,  $C_1$ , should have a maximum capacity of 250 to 500  $\mu\text{fd.}$  Specifications for  $L_1$  may be taken from the coil table, or coils similar to the copper-tubing coils shown in Fig. 802 may be used. Since the two tubes are in series in a push-pull circuit, a somewhat higher LC ratio than is generally recommended for single-tube circuits can be used without detriment to the dynamic stability. The actual condenser capacity in use should be approximately 250  $\mu\text{fd.}$  at the operating frequency, and coils may be propor-

The result is a broad, rough signal, unpleasant to the ear and illegal under the amateur regulations.

To prevent dynamic instability it is essential that the plate supply be the best "pure d.c." obtainable and that the grid bias — or grid leak — be sufficiently high in value. Moreover, too much care cannot be exercised in adjusting the grid excitation. Dynamic instability can be reduced by careful circuit design; the use of a High-C plate tank is especially effective. Such a tank circuit is capable of reducing the amplitude of frequency fluctuations with variations in plate impedance.

## High-C Tank Circuits

● For low-power transmitters a circuit is sufficiently high-C if the actual condenser capacity in use is approximately 400 to 450  $\mu\text{fd.}$  at 3500 and 1750 kc., 250 to 300  $\mu\text{fd.}$  at 7000 kc., and 200 to 250  $\mu\text{fd.}$  at 14,000 kc. Typical tank coils for high-C circuits of low-power transmitters are shown in Fig. 802. They are made of quarter-inch copper tubing for the sake of rigidity and also because the circulating currents in high-C circuits are quite large, even with low power, hence considerable current carrying capacity is needed. The smaller coils illustrate the way in which grid coils for the TNT circuit can be made; they can be wound with fine wire because of the low current flowing in the low-C grid circuit.

tioned accordingly. Grid condensers,  $C_2$ , may be 100 to 250  $\mu\text{fd.}$ , except in the Colpitts circuit, where variable condensers ( $C_5$ ) having a maximum capacity of 50  $\mu\text{fd.}$  should be used, the correct operating value being determined by experiment. Plate blocking and filament bypass condensers,  $C_3$  and  $C_4$ , should be .002  $\mu\text{fd.}$  or larger, although the values are not critical.

The resistance of the grid leak,  $R_1$ , will in general be half that recommended in the tube table for a single tube. Slightly higher values may be found to give better efficiency and a better note.

## Push-Pull Oscillator Circuits

● When two tubes are to be used in the oscillator for the sake of more power output than one alone will give, the tubes should be

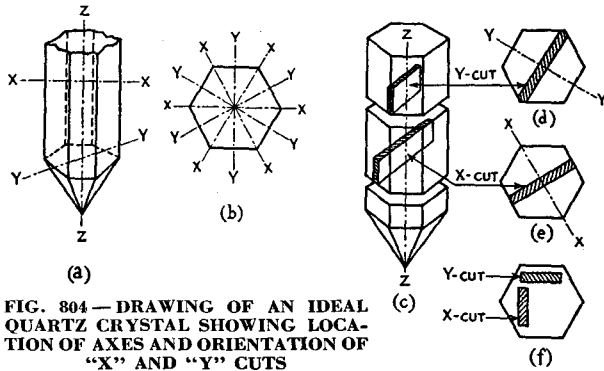

FIG. 804 — DRAWING OF AN IDEAL QUARTZ CRYSTAL SHOWING LOCATION OF AXES AND ORIENTATION OF "X" AND "Y" CUTS

connected in push-pull rather than simply in parallel. Although the power output will be about the same with either method of connection, the frequency stability is improved by the push-pull circuit because the tubes are in effect in series across the tank circuit. Thus, the effective interelectrode capacity is less than that of one tube, and the tube characteristics have a smaller effect on the frequency of oscillation.

Push-pull oscillator circuits are developed from the single-tube circuits already described. Several push-pull circuits are given in Fig. 803. Their similarity to the fundamental circuits from which they are derived will be recognized after inspection. The push-pull Colpitts requires two tuning condensers (or a split-stator condenser) and provides no means of excitation control except through variable grid condensers. The push-pull Hartley is seldom used because the large number of taps on the coil makes a cumbersome mechanical job with the small coils used in high-C circuits.

The unity-coupled circuit resembles the Hartley except that separate coils, very closely coupled, are provided for the grid and plate circuits. In actual practice the grid coils are similar to the copper-tubing coils shown in Fig. 802, while the plate coil is made of small, well-insulated wire run through the center of the tubing. A hole is drilled in the center turn of the copper-tubing coil to allow a connection to be made to the center of the plate coil inside. Where a large number of turns is required, as for a 1750-kc. coil, the two coils may be wound of No. 14 wire on an insulating form, one coil being wound between the turns of the other.

## Crystal-Controlled Oscillators

● Although closely resembling the self-controlled oscillator in principles of operation, the control of frequency in the crystal oscillator is, as the name implies, lodged in a specially-ground slab of piezo-electric crystal, usually quartz. The piezo-electric crystal and its properties have already been discussed briefly in Chapter Four.

The piezo-electric crystal, because of its electro-mechanical properties, will oscillate at a frequency determined almost entirely by its dimensions. When it is properly connected in the controlling oscillator circuit, the line voltage can vary, the antenna can swing, and the tubes may heat without seriously affecting the output frequency of the transmitter. A ripple in the plate-supply voltage will cause amplitude modulation of the output of such an oscillator but can cause practically no frequency flutter.

### Crystal Cuts

● A quartz crystal has three major axes, designated X, Y and Z. The Z axis is the optic axis, the Y axis the mechanical axis, and the X axis the electric axis. A plate cut with its major surfaces perpendicular to an X axis is known as an X-cut plate. This cut is also referred to as the "perpendicular" and "Curie" cut. Plates cut with their major surfaces parallel to an X axis are known as "Y," "parallel," and "30-degree" cuts. The most accepted terms for these two cuts are X-cut and Y-cut. In Fig. 804 is a drawing of a quartz crystal of ideal shape with the three major axes indicated. The drawing also shows the way in which X- and Y-cut crystal blanks are taken from the raw crystal.

In addition to the X and Y cuts, many other cuts are possible. Some of these possess special characteristics; for example, the "AT" cut, derived from the Y cut but with the face of the crystal making an angle with the Z axis instead of being parallel to it as shown in the drawing, is a zero-temperature coefficient crystal. Its oscillation frequency is practically unaffected by temperature changes, which is not the case with X- and Y-cut crystals. Another special cut known as the "V" cut also has a temperature coefficient of practically zero. These cuts demand extreme accuracy in cutting and grinding if the special characteristics are to be obtained. The exact way in which some of the cuts are taken from the crystal are known only to the manufacturers.

# Principles of Transmitter Design and Operation

## Crystal Grinding

● Reliable crystals are available at reasonable prices, so that the ordinary amateur does not attempt to cut and grind his own crystals. Cutting crystals requires special equipment and an accurate means for locating the crystal axes; because of the complications amateurs seldom attempt to cut crystal blanks from raw quartz. However, unfinished X- and Y-cut blanks (slices of quartz which can be ground into oscillating crystals) can be purchased cheaply, and some experimenters like to finish them into crystals which will oscillate at a desired frequency. Again, it is sometimes desired to change the frequency of an already-ground crystal, so that a working knowledge of the method of grinding crystals often is helpful.

When an unground blank is purchased, a statement of the cut should be obtained from the seller, because the grinding cannot be done so easily if the ratio of thickness to frequency is not known. Fig. 805 gives the frequency-thickness relationships. A good micrometer such as the Starrett No. 218-C,  $\frac{1}{2}$  inch, should be used for making measurements. This tool also can be used to make sure that the crystal is the same thickness at all points and that bumps or hollows are not being ground in. The best crystals are usually about 1" square, perfectly flat, and the two major surfaces are parallel.

Grinding can be done by rotating the crystal in irregular spirals on a piece of plate glass smeared with a mixture of No. 200 carborundum and water. It is better to have the crystal stuck to a perfectly flat piece of thin brass or a glass microscope slide than to bear down on the surface of the crystal with the fingers. Even pressure over the whole area of the crystal is essential for flat grinding. The crystal will stick to the flat brass plate or slide if the top of the crystal is moistened with kerosene. The crystal should be frequently tested for oscillation in a test circuit such as one of those shown in Fig. 807. If the crystal should stop oscillating during the grinding process, grinding the edges slightly may make it start again. The frequency can be checked by listening to the signal in a receiver and measuring the frequency as described in Chapter 17. When the frequency is within a few kilocycles of the desired value it is well to use a finer grade of carborundum power for finishing. The FF and FFF or No. 900 grades are suitable for the final grinding.

## Temperature Effects

● In Chapter Four it was pointed out that the piezo-electric crystal is a mechanical vibrator. As a result of molecular friction when the quartz plate is vibrating at the tremendous rate required for the production of radio-frequency oscillations, heat is developed. This heating of the crystal causes it to change its characteristics slightly so that the frequency varies with the temperature. The rate of frequency change with temperature depends upon the type of cut, the precision with which the crystal was cut and ground, its size and shape, and individual characteristics of the quartz used.

The temperature coefficient of a Y-cut crystal usually is positive — that is, the frequency of oscillation increases as the crystal temperature is increased — although with some crystals it may be negative. It can have a wide range of values, varying from plus 100 cycles per million per degree Centigrade to minus 20 cycles per million per degree C. The temperature coefficient of an X-cut plate

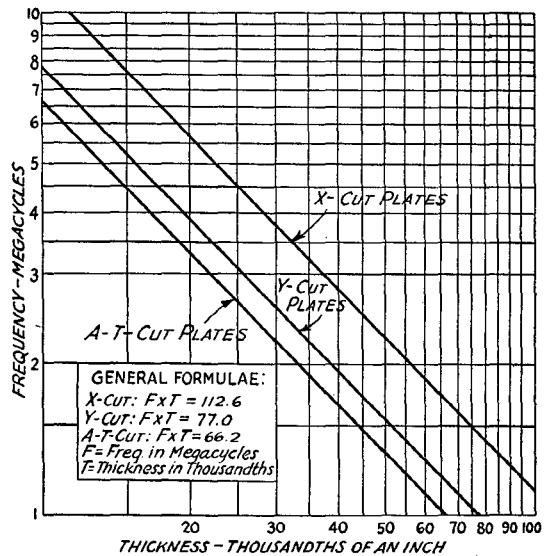

FIG. 805 — FREQUENCY-THICKNESS RELATIONSHIPS OF X-, Y- AND AT-CUT PLATES

is negative — frequency decreases with an increase in temperature — and lies between minus 15 and minus 25 cycles per million per degree C. For example, if through heating the temperature of an X-cut 7-mc. crystal changes from 70 deg. F. to 120 deg. F., the frequency change may be nearly five kilocycles. Should the crystal be followed by a doubler to 14 mc.,

# The Radio Amateur's Handbook . . . . .

the frequency change on the higher-frequency band would be twice as great — enough to shift the signal out of audibility. AT- and V-cut crystals have very low temperature-frequency coefficients, as do some other cuts, so that the

the r.f. current flowing in the crystal circuit as a measure of the power dissipated. A current of 100 milliamperes (0.1 amp.) r.f. usually is considered safe for X- and Y-cut crystals ground for the 1.75- and 3.5-mc. bands. A

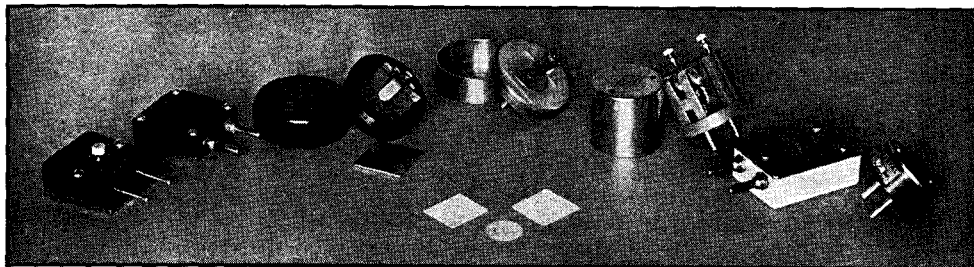

FIG. 806 — CRYSTALS AND CRYSTAL HOLDERS

Several manufactured types of crystal holders are shown. The circular crystal in the foreground is a 20-meter plate.

frequency change with temperature is practically negligible.

Since some temperature rise occurs in all crystal oscillator circuits developing appreciable power, it is evident that in choosing a crystal frequency near the edge of an amateur band the probable "drift" in frequency must be taken into account, remembering that an X-cut crystal drifts to a lower frequency and a Y-cut to a higher frequency as the crystal warms up. With other than zero-temperature coefficient crystals it is best not to attempt "crowding the edge" of a band.

### Power Limitations

● Heating is greater the greater the amplitude of the crystal vibration; in other words the greater the r.f. voltage across the crystal. The vibration of a quartz crystal is extremely complex; in addition to vibrations of the type wanted for frequency control, there may also be present vibrations of other types which contribute to the heating and produce mechanical stresses in the crystal. When the vibration amplitude is high these stresses may be great enough to shatter the crystal, hence the power-handling capabilities of the crystal are limited. Secondary vibrations are always present in X- and Y-cut crystals; the AT-cut crystal is almost free from them, hence is capable of handling more power than either the X- or Y-cut.

Since the vibration amplitude is a function of the r.f. voltage appearing across the faces of the crystal, it is essential that this voltage be limited to a value safe for the type of crystal used. It is difficult, however, to measure r.f. voltage, so that it is more common to use

somewhat lower value is the maximum for 7-mc. crystals. AT-cut crystals can operate safely with currents as high as 200 ma. The current depends on the plate voltage and type of tube and circuit used.

### Crystal Mountings

● To make use of the piezo-electric oscillation of a quartz crystal, it must be mounted between two metal electrodes. There are two types of mountings, one in which there is an air-gap of about one-thousandth inch between the top plate and the crystal and the other in which both plates are in contact with the crystal. The latter type is simpler to construct and is generally used by amateurs. It is essential that the surfaces of the metal plates in contact with the crystal be perfectly flat. Satisfactory mountings can be purchased from most dealers in crystals or can be made up by the amateur.

Grit or an oily film on the surface of a crystal will affect its operation and will sometimes prevent oscillation. The crystal should be cleaned whenever erratic behavior or stoppage of oscillation gives evidence of a dirty condition.

Carbon tetrachloride (Carbona) or alcohol are the best cleaning fluids. Soap and water will do quite well, however. Handling of the crystal is especially likely to give it an oily surface, and the crystal should always be cleaned after it has been touched by the hands.

A holder having a heavy metal bottom plate with a large surface exposed to the air is advantageous in radiating quickly the heat generated in the crystal and thereby reducing temperature effects. Such a holder is especially advantageous with X- and Y-cut plates.

The type of holder used will have some

# Principles of Transmitter Design and Operation

effect on the frequency of oscillation of the crystal. Different plate sizes, pressures, etc., will cause slight changes, amounting to perhaps a kilocycle or so, so that if a crystal is being ground to an exact frequency it should be tested in the holder and with the same oscillator circuit with which it will be used in the transmitter. With Y-cut plates it is often possible to cause the crystal frequency to "jump" simply by changing the pressure of the top plate or by moving it about on the crystal. The present tendency with manufactured crystals is to sell them in individual holders to insure retaining calibration and to protect the crystal from dust and dirt.

In the air-gap type of holder, the frequency of oscillation depends to some extent upon the size of the gap between the top plate and crystal. This property can be used to advantage with the AT-cut crystal so that by using a holder with a top plate with closely adjustable spacing a controllable frequency variation can be obtained. The extent of the variation possible depends on the frequency; a 3.5-mc. crystal will oscillate without perceptible variation in power output over a range of about 5 kc. With harmonic operation, this frequency change becomes 20 kc. on 14 mc. X- and Y-cut crystals are not generally suitable for this type of operation because they have a tendency to "jump" in frequency with different air gaps. The freedom from secondary vibrations which characterizes the AT- and a few other cuts makes smooth frequency variation possible. Suitable holders are available commercially.

## Triode Crystal Oscillators

● The simplest crystal oscillator circuit is the triode circuit shown in Fig. 807. When the plate tank circuit is tuned to a frequency slightly higher than the natural frequency of the crystal, the feed-back through the grid-plate capacity of the tube excites the grid circuit, and the crystal oscillates at approximately its natural frequency.

The power obtainable from the crystal oscillator will depend upon the type of tube used, the plate voltage, and the amplitude of vibration of the crystal, or more precisely, the amplitude of the r.f. voltage developed as a result of the mechanical vibration, as we have seen. In the simple triode oscillator circuit of Fig. 807, the limit of plate voltage that can be used without endangering the crystal is about 250 volts for X- and Y-cut crystals, although this

figure will vary with the crystal itself, its mounting, and the type of tube used. Tubes with low amplification factors — the 45, for instance — should be operated at lower plate voltage than tubes with medium or high  $\mu$ 's, because low- $\mu$  tubes require a relatively large exciting grid voltage for a given output.

With the r.f. crystal current limited to a safe value of about 100 milliamperes, as measured by an r.f. galvanometer or low-range r.f. ammeter inserted in series with the crystal, the power output obtainable from triode crystal oscillators is about five watts at most. The simple triode oscillator has been generally superseded by more suitable types.

## The Pentode Oscillator

● Since the r.f. voltage amplitude (which determines the power output of the oscillator tube) generated by the crystal is limited by the safe vibration amplitude of the crystal, obviously the greatest power output can be secured without danger to the crystal by choosing a tube of high power sensitivity (see Chapter Five). The power pentode is such a tube, hence we find that pentodes are widely used as

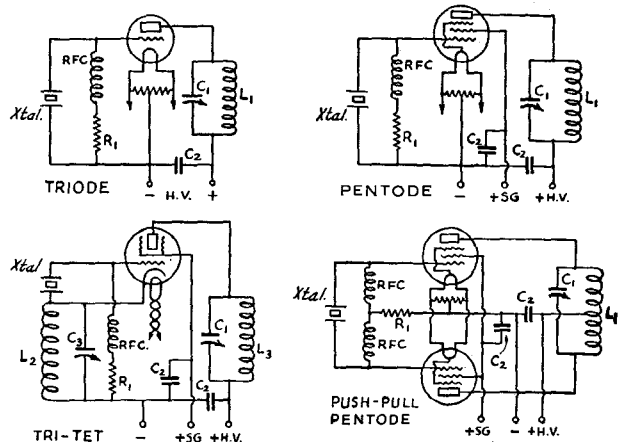

FIG. 807 — CRYSTAL OSCILLATOR CIRCUITS

In crystal oscillator output tank circuits it is generally advisable to use a fairly high LC ratio for best output and efficiency. The plate tuning condensers, C<sub>1</sub>, may have a maximum capacity of 50 to 100  $\mu$ fd., with tank coils, L<sub>1</sub>, having suitable inductance to make the circuit resonant at the crystal frequency. Coil specifications can be taken from the coil table. The cathode tank circuit, C<sub>3</sub>L<sub>2</sub>, in the Tri-tet oscillator is adjusted as described in the text; the output circuit, C<sub>1</sub>L<sub>1</sub>, will be similar to the output circuits used in the other crystal oscillators. Plate and screen bypass condensers, C<sub>2</sub>, may be .002  $\mu$ fd. or larger. The resistance of the grid leak, R<sub>1</sub>, should be 5000 or 10,000 ohms except in the Tri-tet circuit, where a leak of 25,000 to 50,000 ohms will be found advisable, especially if the output circuit is tuned to a harmonic.

crystal oscillators in amateur transmitters. Along with high power-sensitivity, the presence of the screen grid in the pentode reduces the grid-plate capacity of the tube so that the feed-back voltage is less than would be the case with an equivalent triode operating at the same plate voltage. As a result, pentode crystal oscillators can be operated at higher plate voltages than triodes.

The pentode and tetrode tubes designed for audio power work, such as the 47, 2A5, 41, 42, and 6L6, 48 and 6F6, are excellent crystal oscillator tubes. For a given plate voltage the crystal heating will be less with a pentode than a triode as the oscillator tube; alternatively, for the same amplitude of crystal vibration, higher plate voltages can be used with the pentodes, resulting in greater power output. A typical pentode oscillator circuit is shown in Fig. 807. It has been found best to operate the screen grid at approximately 100 volts; plate voltages up to 500 may be used without danger to the crystal. Power outputs of ten watts or more can be obtained quite readily with 400 to 500 volts on the plate.

### High-Power Pentode Oscillators

● Transmitting pentodes also can be used as crystal oscillator tubes, the larger tubes giving large outputs. Since these tubes have quite thorough screening, it may be necessary in some cases to provide additional feedback between plate and grid to ensure oscillation. This feedback can be secured by bringing a wire from the plate of the tube close to a similar wire connected to the grid of the tube to form a very low-capacity condenser, or by connecting a variable condenser of the type used

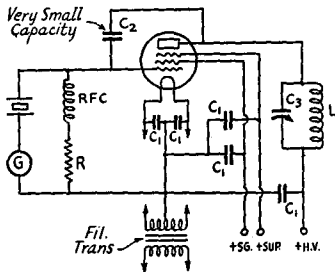

FIG. 808 — CIRCUIT FOR A HIGH-POWER PENTODE OSCILLATOR WITH EXTERNAL FEEDBACK

This circuit is suitable for use with RK20, RK28 and 803 tubes. Suitable values for  $C_1$  are .001 or .002  $\mu$ fd.,  $C_2$  as in text, and  $C_3$ , 100  $\mu$ fd. The grid leak,  $R$ , should be about 15,000 ohms, while  $L$  is wound to be resonant, in conjunction with  $C_3$ , at the frequency of the crystal used. The r.f. crystal current should not exceed the safe value for the type of crystal used.

to neutralize low-capacity triodes (such as the neutralizing condensers illustrated in Figs. 923 and 924 in the next chapter) between control grid and plate. The circuit is shown in Fig. 808.

Extreme care should be used in providing the additional feedback, since slightly too much feedback may be sufficient to crack the crystal with high voltage on the oscillator tube. To adjust, start with zero feedback capacity and gradually increase it, watching the r.f. crystal current at the same time. The capacity may be increased to the point where the r.f. crystal current is the maximum value recommended for the type of crystal used, and then left alone. This adjustment should be made with the oscillator unloaded (the condition which gives maximum feedback) so that the crystal will be safe under all conditions of operation.

### Push-Pull Crystal Oscillators

● Two tubes may be connected in push-pull in the crystal oscillator, if desired; likewise, tubes may be connected in parallel. Just as with self-controlled oscillators, parallel operation entails no circuit changes other than tying all identical tube elements together. In the push-pull circuit, the crystal is connected between the grids of the tubes, as shown in the typical push-pull pentode circuit of Fig. 807.

Push-pull oscillators are useful for exciting a following push-pull amplifier on the same frequency. However, since push-pull circuits are not suited to frequency doubling without resort to complicated circuit arrangements, the push-pull crystal oscillator is seldom used in multi-band amateur transmitters.

### Crystal Oscillator Circuit Constants

● Triode and pentode crystal oscillator circuits are practically identical except for the screen supply in the pentode circuit. The screen, however, plays no part in the operation of the pentode circuit except to perform its usual function of accelerating electron flow to the plate; it is bypassed to the cathode through a condenser of low reactance at the operating frequency and therefore has the same r.f. potential as the cathode.

Since quartz is an excellent insulator, parallel feed (see earlier section) must be used in the grid circuit to provide a path for the flow of d.c. grid current. In all circuits shown a grid leak furnishes the operating bias when the tube is oscillating; the r.f. choke in series prevents r.f. current from flowing through the leak. Occasionally the r.f. choke is omitted in cases where a high-resistance leak is called for — if the oscillator tube is a 45, for example — but it is

# Principles of Transmitter Design and Operation

usually good practice to include the choke. The choke should never be omitted except when a non-inductive grid leak is used, and then only when the leak resistance is of the order of 20,000 ohms or higher. Lower values place a considerable load on the crystal and may reduce the power output or even prevent the crystal from oscillating. With the receiving-type pentodes previously mentioned, a leak resistance of 5000 to 10,000 ohms is generally satisfactory. A power rating of one or two watts is sufficient.

In the pentode circuits using small tubes, the screen voltage may be supplied from a separate source of about 100 to 150 volts, from a voltage divider across the plate supply, or through a series resistor from the positive side of the plate supply. With the latter method, a resistance of 50,000 ohms, two- to five-watt rating, is commonly used.

It is unnecessary to use a high-C tank circuit in the crystal oscillator for the sake of stability, since the stability is determined almost solely by the crystal itself. Greater ease of oscillation, better efficiency and higher harmonic output are usually secured when the tank has a high L-C ratio; all of these are desirable in the case of the crystal oscillator. A tank condenser,  $C_1$ , having a maximum capacity of 50 to 100  $\mu\text{mfd}$ . is large enough. A receiving-type midget condenser has ample plate spacing.

The inductance of the tank coil,  $L_1$ , should be such that the tank circuit will be resonant at the crystal frequency at some setting of  $C_1$ . Dimensions can be taken from the coil chart given in this chapter. The coils can be wound with small-gauge wire, since the tank current will not be large with a high L-C ratio when handling the amount of power developed by the usual crystal oscillator.

## Tuning Adjustments

● A crystal oscillator is quite easy to adjust, since there is little the operator can do to change the frequency or to have an adverse effect on the frequency stability. Tuning therefore becomes chiefly a matter of obtaining the optimum amount of power from the oscillator.

Using a plate milliammeter as an indicator of oscillation (a 0-100 ma. d.c. meter will have ample range for all low-power oscillators), the plate current will be found to be steady when the circuit is in the non-oscillating state, but will dip when the plate condenser is tuned through resonance at the crystal frequency. Fig. 809 is typical of the behavior of plate current as the tank condenser capacity is varied. As the capacity is increased from minimum, there will be a rather gradual decrease

in plate current when oscillations commence. This continues until the point A is reached, when there will be a sharp rise in plate current, followed by cessation of oscillations. An r.f. indicator, such as a small neon bulb touched to the plate end of the tank coil, will show maximum at point A. However, when the oscillator

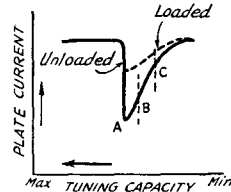

FIG. 809 — D.C. PLATE CURRENT VS. PLATE TUNING CAPACITY WITH THE TRIODE OR PENTODE CRYSTAL OSCILLATOR

Solid line, oscillator unloaded; dashed line, loaded.

is delivering power to a load it is best to operate in the region B-C, since the oscillator will be more stable and there is less likelihood that a slight change in loading will throw the circuit out of oscillation. This is likely to happen when operation is too near the critical point, A. Also, the crystal current is lower in the B-C region.

When power is taken from the oscillator, the dip in plate current is less pronounced, as indicated by the dotted curve. The greater the power output the less is the dip in plate current. If the load is made too great, oscillations will not start. The load may be an antenna or a following amplifier stage; methods of adjusting loading will be considered later in the chapter.

The greater the loading, the smaller the voltage fed back to the grid circuit for excitation purposes. This means that the r.f. voltage across the crystal also will be reduced, hence there is less crystal heating when the oscillator is delivering power than when operating unloaded. For this reason it is possible to operate a loaded oscillator at higher plate voltage than is possible with an unloaded oscillator for the same crystal heating.

## Harmonic Generation — The Tri-Tet

● Since the crystal is a single-frequency device, many circuits have been devised to obtain harmonic output from the oscillator tube. One of the most successful is the "Tri-tet" oscillator, which utilizes a multi-element tube to act both as oscillator and frequency multiplier. The circuit is shown in Fig. 807, arranged for use with a screen-grid tube having an indirectly-heated cathode. In the Tri-tet oscillator circuit the screen grid is operated at ground

potential while the cathode assumes an r.f. potential above ground. The screen-grid acts as the anode of a triode crystal oscillator, while the plate or output circuit is simply tuned to the oscillator frequency or a multiple of it.

If the output circuit is to be tuned to the same frequency as the oscillator, a well-

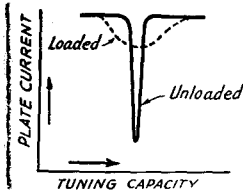

FIG. 810—D.C. PLATE CURRENT VS. PLATE TUNING CAPACITY WITH THE TRI-TET OSCILLATOR

screened tube such as the 802, RK23, RK25, or 89, must be used, otherwise the tube may oscillate as a tp.t.g. oscillator. For harmonic generation only, the 59, 2A5 or equivalent tubes will deliver good output, but are not sufficiently well screened for fundamental operation.

Because of the way in which the circuit operates, a relatively large r.f. voltage appears across the crystal under some conditions. This will cause heating of the crystal if certain operating precautions are not observed. The cathode tank circuit,  $L_2C_3$ , should not be tuned to the frequency of the crystal, as might be expected, but to a considerably higher frequency. For example,  $L_2C_3$  will be tuned to approximately 5000 kc. when working with a 3500-kc. crystal, and the circuit constants should be proportioned accordingly. A circuit using a coil which would require a condenser of relatively high capacity to be resonant at the crystal frequency (high- $C$ ) will give best results. Tuning off on the high-frequency side of resonance not only reduces crystal strain but usually also increases the output. Another second factor affecting crystal heating is the voltage on the screen grid, which must be kept at the correct operating value for the type of tube in use. The screen voltage should not exceed 125 volts with tubes of the 59, 89, and similar types. Plate voltages up to 350 may be used.

With pentode-type tubes having separate suppressor connections, the suppressor may be tied directly to the screen or may be operated at about 50 volts positive. The latter method will give somewhat higher output than with the suppressor connected to ground or the cathode. More than 50 volts usually does not increase the output perceptibly.

Besides harmonic output, the Tri-tet circuit

has two other advantages over simple triode or pentode oscillators. It is a very persistent oscillator — crystals rarely fail to “start” when plate voltage is applied. “Crankiness” with regard to oscillation is a common failing with the simpler circuits, especially if the crystal is not as active, piezo-electrically, as it might be. The second advantage is the buffering action attributable to electron-coupling between crystal and output circuits. This makes the crystal less susceptible to changes in loading (such as might be caused by tuning a following stage) and hence enhances the frequency stability.

### Tri-Tet Circuit Constants and Tuning

● The importance of using a high- $C$  cathode tank circuit in the Tri-tet oscillator has been emphasized in the preceding section. The constants of the plate tank circuit,  $C_1L_3$ , will resemble those of ordinary crystal oscillators; that is, the circuit will have a high  $L-C$  ratio. For harmonic generation, the tuning condenser need not have a maximum capacity of more than 50  $\mu\text{fd.}$ , the inductance being proportioned accordingly for the frequency used.

The tuning procedure is as follows: With  $C_1$  at a random setting, turn  $C_3$  downwards from maximum capacity until there is a sudden change in plate current. Reduce the capacity a bit more, then turn  $C_1$  until there is a sharp dip in the plate current, indicating that the plate circuit is in resonance. Set  $C_1$  so that the plate current is minimum. The load circuit may then be coupled and adjusted so that the oscillator delivers power. The minimum plate current will rise; it may be necessary to retune  $C_1$ , when the load is coupled, to bring the plate current to a new minimum. Fig. 810 shows typical behavior of plate current with plate condenser tuning.

After the plate circuit is adjusted and the oscillator is delivering power, the cathode condenser  $C_3$  should be readjusted to obtain optimum power output. The setting of  $C_3$  always should be as far toward the low-capacity end of the scale as is consistent with good output; it may in fact be desirable to sacrifice a little output since doing so reduces the current through the crystal and thus reduces heating.

The tuning procedure is the same for both fundamental and harmonic operation. The oscillator gives good output on the second harmonic, but the output drops off rapidly on higher harmonics.

### High-Power Tri-Tet Oscillators

● Transmitting pentodes of high power sensitivity such as the RK20, RK28 and 803 are



# Principles of Transmitter Design and Operation

suitable for use with the Tri-tet circuit at a quite high power level. From experimental work with the tubes it has been found that plate voltages as high as 1000 volts can be used without danger to the crystal provided the instructions in the preceding section with regard to cathode tuning are rigorously followed.

With a 3.5-mc. crystal, power outputs of the order of 50 watts can be obtained at this voltage on the fundamental frequency, with 35 to 40 watts on the 7-mc. harmonic. In a typical RK20 Tri-tet oscillator circuit with a 7-mc. crystal, a fundamental output of 40 watts is readily obtainable; on the 14-mc. harmonic the output is in the vicinity of 25 watts.

## Regenerative Tri-tet Oscillator

● Although the output on the harmonics higher than the second is relatively small in the normal Tri-tet oscillator, it is possible with pentode-type tubes having separate suppressor connections to introduce regeneration in such a way that the fourth-harmonic output is increased to a useful level, thus making a single oscillator circuit operate on three bands with one crystal. To do this, some of the energy in the plate circuit is fed back to the suppressor, as shown in Fig. 810-B.

The feedback coil,  $L_4$ , is closely-coupled to  $L_3$  and wound in the same direction, with the coil ends connected as indicated. Provision is made for applying positive voltage to the suppressor (this usually increases the output) but the inner end of  $L_4$  may be connected directly to ground if desired, the condenser  $C_4$  being omitted. The number of turns on  $L_4$  should be adjusted so that, with the crystal removed from the circuit, the plate-suppressor circuit will just oscillate without crystal excitation. With the crystal plugged in, the fourth-harmonic plate circuit will be controlled by the crystal.  $L_4$  usually will have about half the number of turns on  $L_3$ .

The increase in output resulting from introducing regeneration in this manner is not appreciable on the second harmonic, hence the additional complication is not warranted for such operation. As a means of increasing fourth-harmonic output, however, the modification is well worth while.

## R.F. Power-Amplifiers

● Amplifiers intended for operation on the same frequency as the exciting source are of two types — triode and screen-grid. When a triode is used as a straight amplifier provision must be made in the circuit for cancelling out the effect of feedback of energy from plate to grid through the grid-plate capacity of the

tube. This process is called "neutralization." If the tube is not neutralized, it will oscillate as a tuned-plate tuned-grid oscillator because its output tank circuit and the tank circuit of the preceding stage — the *driving stage* or *driver* — to which the amplifier's grid circuit is coupled, are tuned to the same frequency.

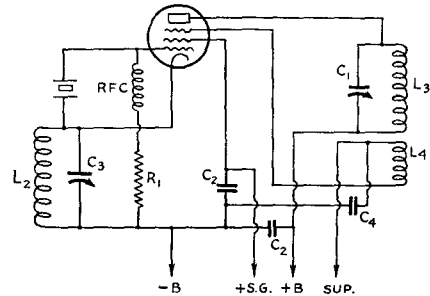

FIG. 810-B — REGENERATIVE TRI-TET CIRCUIT FOR INCREASING FOURTH-HARMONIC OUTPUT

*This circuit may be used with pentode-type tubes having suppressor connections brought out (802, RK23-25, 89, etc.). Circuit values are the same as given in Fig. 807 with the exception of  $C_4$ , which should be .001  $\mu$ fd. or larger, and  $L_4$ , the adjustment of which is explained in the text.*

Screen-grid tubes (either tetrode or pentode type) do not require neutralization because of the action of the screen in reducing grid-plate capacity, as described in Chapter Five. To prevent self-oscillation, however, it is essential that there be no coupling, either magnetic or through stray capacities, between the grid and plate circuits. This often calls for the use of shielding.

## Amplifier Operating Requirements

● In all cases except when certain types of modulation for radio-telephony are to be applied to the r.f. amplifier, the object of adjustment is to obtain maximum r.f. power output consistent with tube ratings and requirements as to purity of emissions imposed by the amateur regulations. Assuming fixed filament and plate voltages, the adjustments which affect the output are those of grid bias, excitation voltage, and plate loading. These three are all interrelated, a change in one requiring a change in the other two for optimum results.

The special case of the modulated amplifier is treated in Chapter Eleven. The principles discussed here are applicable.

## Load Impedance

● A simplified amplifier circuit, including only essentials and neglecting the necessity for neu-

tralization, is shown in Fig. 811. The discussion centered about it will apply equally well to screen-grid tubes, since the screen (and suppressor, if the tube is a pentode) are at ground potential and hence have no effect on the r.f. operation of the circuit aside from establishing the tube characteristics. The tuned tank circuit in series with the plate of the tube constitutes the load for the tube. When tuned to resonance it is practically equivalent to a pure resistance, as explained in Chapter Four. The

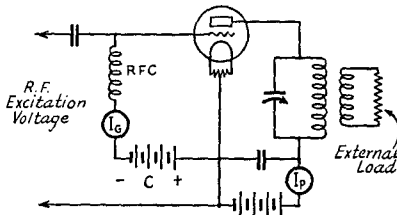

**FIG. 811 — A SIMPLIFIED AMPLIFIER CIRCUIT**  
*The resistor connected across the coupling coil represents the load to which the amplifier is delivering power; it may be an antenna or a following amplifier stage.*

value of equivalent resistance represented by the tank is dependent upon the ratio of inductance to capacity, the resistance inherent in the tank itself, and upon the effective resistance coupled into the tank from the external load circuit, which may be an antenna or a following amplifier tube grid circuit. The tank resistance or impedance decreases as the coupling to the external circuit is increased, and also decreases as the ratio of capacity to inductance is increased.

For every condition of bias and excitation voltage there is an optimum value of load resistance or impedance which will give best output and efficiency.

### Measurement of Excitation

● Since measurement of r.f. excitation voltage is rather difficult without special apparatus such as a vacuum-tube voltmeter, it is customary to take the rectified grid current as a measure of the r.f. voltage and power supplied to the grid circuit of the amplifier. Under a given set of conditions, the higher the grid current the greater is the excitation voltage. However, a change in load resistance or a change in fixed bias or grid leak resistance will cause a change in the value of d.c. grid current for the same excitation voltage, so that readings taken under different operating conditions are not comparable.

### Effect of Excitation

● The value of excitation voltage has a marked effect on the operation of the amplifier. A typical set of performance curves, showing behavior of power output, power amplification ratio, and efficiency as a function of d.c. grid current are shown in Fig. 812. Fixed values of load resistance and grid bias are assumed. Inspection of the curves shows that output and efficiency increase rapidly at first as the excitation is increased, then more slowly. The grid driving power curve rises rapidly beyond the maximum power amplification ratio, showing that a relatively large increase in excitation is necessary to produce a comparatively small increase in power output and efficiency once the optimum point — just to the right of the bend in the output and efficiency curves — is passed.

Assuming fixed plate voltage and load resistance, there is an optimum bias value which will give best results for every value of excitation voltage. The greater the excitation, the greater should be the bias. The power consumed in the amplifier grid circuit also is greater under these conditions. The grid power, furnished by the exciter, is dissipated in the grid-filament circuit of the tube, appearing as heat at the grid, in the bias supply, and also, particularly at the higher frequencies, as dielectric loss in the glass of the tube.

### Efficiency and Output

● The attainable plate efficiency is of great importance in determining the operating conditions for the amplifier. If the safe plate dissipation rating of the tube were the only

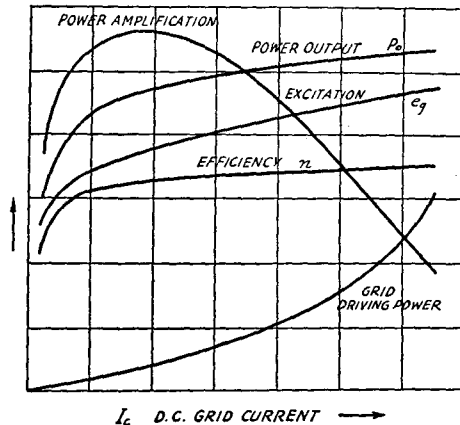

**FIG. 812 — EFFECT OF GRID EXCITATION ON POWER AMPLIFIER PERFORMANCE**

# Principles of Transmitter Design and Operation

consideration, it would be desirable to obtain the highest possible plate efficiency, since the power output would be limited solely by the efficiency. For example, a tube having a plate dissipation rating of 100 watts operating at a plate efficiency of 90% could handle an input of 1000 watts, giving 900 watts output, while the same tube at 70% efficiency could handle an input of only 333 watts, giving an output of 233 watts. The plate dissipation — the difference between input and output — is the same in both cases, 100 watts.

There are other considerations, however, which limit the useful plate efficiency. Assuming that the plate input is not to exceed the manufacturer's ratings for the tube, the difference between 70% and 90% efficiency is not so great. For instance, taking the same 100 watt tube and assuming that the 70% efficiency condition corresponds with the ratings, an efficiency of 90% would increase the output to only 300 watts (333 watts input). The additional 67 watts of output, an increase of about 27%, would require inordinately large driving power because, as shown by Fig. 812, the efficiency increases very slowly beyond the optimum point, while the reverse is true of the driving power required.

A second factor which limits the usable efficiency is the fact that high values of efficiency are attained only through the use of high values of load resistance, which in turn requires the use of very high plate voltage. Not all tubes are suited to operation at plate voltages much above normal, while from an economic standpoint a high-voltage power supply may represent greater cost than the installation of a second tube operating at lower voltage to give the same order of power output at lower plate efficiency.

Most tubes are designed for operation as r.f. power amplifiers under average conditions, where the plate efficiency is in the vicinity of 70%. This corresponds to the optimum point on the curves of Fig. 812. They will deliver their rated power output at moderate plate voltages, considering the size of the tube, and with fairly low values of driving power. A few tubes available to amateurs, however, can be operated at relatively high plate voltages and are provided with oversize filaments to stand up under high-voltage operation. They can be operated at moderate plate voltages with normal efficiency or can be used by the experienced amateur, accustomed to careful tuning, for obtaining large power outputs at high plate efficiency.

## Tank Circuit Impedance — Coupling Efficiency

● As we have said, for a given set of operating conditions there is a value of plate load resist-

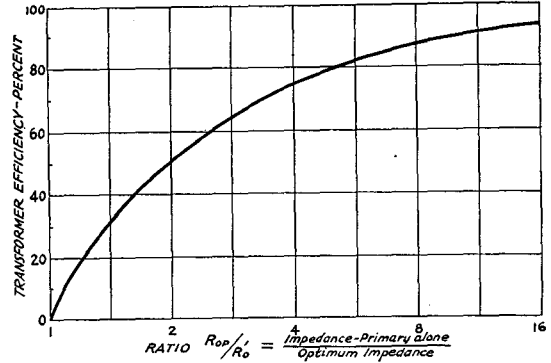

FIG. 813 — VARIATION OF COUPLING TRANSFORMER EFFICIENCY WITH TUNED CIRCUIT IMPEDANCE

This curve and those of Fig. 812 are from data by H. A. Robinson, W3LW.

ance which will give highest efficiency. So far as the plate efficiency of the tube itself is concerned, it does not matter how this load resistance is obtained; that is, the tube will work equally well into an actual resistor or into a tank circuit having any practicable constants so long as the resistance or impedance represented by the tank is the desired value. However, the distribution of the power output between the tank circuit and the load is affected by the inherent (unloaded) impedance of the tank circuit. Since power consumed in the tank circuit is a loss, this is the same thing as saying that the efficiency of the tank circuit in delivering power from the tube to the external circuit is affected by the unloaded tank impedance.

The impedance of the unloaded tank circuit at resonance is equal to  $L/CR$ , where  $L$  is the inductance,  $C$  the capacity, and  $R$  the effective resistance. The higher the ratio of the unloaded tank impedance to the optimum load impedance for the tube, the greater the transfer efficiency; the relationship is shown by the curve of Fig. 813. It is evident that the impedance of the tank alone should be at least ten times the optimum load impedance for high transfer efficiency. The tank impedance can be raised in two ways: by lowering the resistance through the construction of low-loss coils and by careful placement of parts, or by raising the  $L-C$  ratio. With practicable circuits, it is much easier to raise the tank impedance by

# The Radio Amateur's Handbook . . . . .

increasing the  $L-C$  ratio than by attempting to reduce the resistance.

## Tank Impedance and Harmonic Output

● When a high-impedance tank circuit is used, combined with high grid bias and large values of excitation voltage, a large proportion of the power output is on harmonics of the fundamental frequency. The harmonic power, although contributing to the plate efficiency, is not useful for signalling purposes and often is inadvertently radiated by the antenna system, causing interference on other frequencies. Since our bands are not wholly in harmonic relation, at some operating frequencies this may mean that the transmitter is radiating on a frequency not assigned to amateurs.

## Optimum $L-C$ Ratios

● Because of the conflicting requirements of high tank-circuit impedance for efficient operation, and low tank-circuit impedance for harmonic suppression, compromise is necessary in choosing the  $L-C$  ratio. The optimum ratio will depend upon the operating plate voltage and plate current, and also on the type of service for which the amplifier is intended — that is, c.w. telegraph or 'phone. The following formula gives a practical maximum  $L-C$  ratio for single-ended (single tube, or tubes in parallel) amplifiers:

$$C = K \frac{\text{D.C. Plate Current (ma.)}}{\text{Plate Volts} \times \text{Freq. (mc.)}}$$

The constant  $K$  is 2600 for c.w., 5200 for 'phone. The condenser capacity so determined is the *actual capacity in use*, not merely the maximum-capacity rating of the particular condenser used. The lower  $L-C$  ratio recommended for 'phone work is necessary to make the amplifier linear, a primary requirement for radiotelephony.

It should be remembered that the capacity given by the formula above represents a minimum value. A higher value can be used when operating at normal efficiency without appreciable reduction in output, but with increased harmonic suppression.

## Push-Pull and Parallel Operation

● Other things being equal, the power output from two tubes will be the same regardless of whether they are connected in parallel or push-pull. The same is true of the power required from the driver. However, there are certain practical considerations which may make one method of connection preferable to the other.

Although the excitation power required is

the same with either method of connection, for the balanced circuit the r.f. voltage must be twice as high as with parallel operation. This may require a relatively high  $L-C$  ratio in the tank circuit connected to the grids of the tubes. Fortunately the reduction in effective tube capacity with push-pull favors the use of a sufficiently high  $L-C$  ratio so that this requirement usually can be met without difficulty. In either parallel or push-pull operation the d.c. grid current for the two tubes should be twice that drawn by one tube alone.

At the higher frequencies a limit is placed on parallel operation by the shunting effect of tube capacities in increasing the minimum capacity of the circuit to such an extent that a tank circuit of reasonable efficiency cannot be secured. However, at ordinary amateur frequencies — up to 14 mc., at least — tubes designed for high-frequency work (the types marked with an asterisk in the triode tables of Chapter Five) can be paralleled without particular difficulty.

Plate efficiency is favored to some extent by parallel operation as contrasted to push-pull. The optimum load impedance for two tubes in parallel is just half the value for one tube alone, since the total plate resistance of the two tubes is half that of either by itself. A tank having a given  $L-C$  ratio therefore will have greater transfer efficiency with two tubes in parallel than with one alone. Conversely, the  $L-C$  ratio can be halved for the same transfer efficiency, with a corresponding reduction in relative harmonic output.

The opposite is true with tubes in push-pull. The balanced circuit makes it necessary that each plate-cathode circuit be connected across only half the tank; the impedance into which each tube is working is only one-quarter that of the whole tank circuit with this method of connection. So far as the tube is concerned, this is equivalent to a 4-to-1 reduction in  $L-C$  ratio. Since the impedance of the part of the tank across which one tube is connected reaches the optimum value with looser coupling than is the case when the tube is connected across the whole tank, the power output will be less, which means a reduction in efficiency. To bring the efficiency back to a value comparable with the single tube, the  $L-C$  ratio must be quadrupled — that is, the capacity should be halved and the inductance doubled. For push-pull, then, the constant  $K$  in the formula given in the preceding section should be reduced to 650 for c.w., and 1300 for 'phone.

The higher effective impedance of the tank circuit with push-pull operation does not have

# *Principles of Transmitter Design and Operation*

an appreciable effect on the harmonic output because the even harmonics are balanced out as an inherent property of the push-pull connection. Thus only the odd harmonics are present in the output, assuming that the circuit is well balanced and that tubes having identical characteristics are used. The third harmonic, which is the one of greatest importance, is relatively small compared to the second harmonic. Thus push-pull operation may be advantageous from the harmonic standpoint even though higher  $L$ - $C$  ratios are used.

Push-pull is usually to be preferred to parallel operation because a balanced circuit is often found easier to handle than a single-ended or unbalanced circuit, especially at high frequencies. This is particularly true of neutralized amplifiers; at 14 mc. and higher, perfect neutralization is difficult, if not impossible, in a single-ended stage, with any tubes except those having very low interelectrode capacities and with grid and plate leads brought out separately, not through the tube base. The symmetry of the push-pull stage balances out the effects of stray capacity between tube elements and between other parts of the circuit, and permits easy and practically perfect neutralization. For this reason many amateurs prefer to use two tubes in push-pull rather than a single tube of twice the power rating.

## **Circuit Values in Amplifiers**

● The values of circuit components other than tank constants and coupling condenser capacities (to be discussed in a succeeding section) are seldom critical. By-pass condensers, for example, are used simply to provide a low-impedance path for the flow of r.f. current, and so long as the reactance of the condenser is low compared to the impedance of the part of the circuit across which the condenser is connected, this requirement will be met. The question is therefore simply one of getting a condenser large enough. Values from .001 to .01  $\mu$ fd. are regularly used.

In the larger sizes, .01  $\mu$ fd. and up, condensers sometimes will exhibit some inductance as well as capacity, introducing the possibility that the condenser may be self-resonant at some high frequency. A condenser having such resonance will cause the circuit to work poorly at frequencies near the condenser's natural period. It is advisable to use mica or glass condensers in high-voltage, high-frequency circuits, although non-inductively wound paper condensers will give good service within their voltage ratings.

In the diagrams given in this chapter the

filament return circuit of filament-type tubes usually is shown with a center-tapped resistor, the plate and grid returns being brought to the center-tap. The purpose of the center-tap is to prevent hum-modulation of the tube's output by balancing the voltages on both sides of the filament with respect to the grid return. In practical transmitters this balancing may be done either by a resistor, as generally shown, or by a center-tap on the filament-supply winding. The results are the same with either method. If a non-inductive center-tapped resistor is used, it may be mounted close to the filament terminals on the tube socket and used as an r.f. return as well. However, filament bypass condensers usually replace the resistor for the r.f. return in all but low-power circuits using 2.5-volt tubes, and in all circuits where the center-tapped resistor or filament transformer has to be located at some distance from the tube. The resistor shown in these drawings is simply a convention, used to represent either a resistor or bypass condensers or both; in other words, it is a diagrammatic "shorthand" for the complete filament circuit.

Filament bypass condensers usually have a capacity of .002  $\mu$ fd. or more. The larger the condensers the better (if they are non-inductive) since they are called upon to bypass a low-impedance part of the circuit. These condensers are not required when the tube has an indirectly-heated cathode, the r.f. and d.c. returns being made directly to the cathode connection. The filament supply for such tubes usually is treated to reduce hum, however. This may be done by a center-tap of the type used with filament-type tubes, by grounding one side of the heater supply directly, or by connecting either or both of the heater terminals to ground through bypass condensers of .01  $\mu$ fd. or more. An r.f. bypass on the heater is advisable in radio-frequency circuits to keep the heater at ground potential.

## **Interstage Coupling Methods**

● With any amplifier tube, some means must be provided for feeding into its grid circuit the r.f. power generated by the preceding oscillator or driver. To do this effectively many types of inter-stage coupling have been devised. Coupling methods may be divided into three general classes, capacitive or direct, inductive, and transmission line.

The problem of coupling two stages is complicated by the differing characteristics of different types of tubes and by the use of single- and double-tube stages, the latter often being balanced or push-pull stages. Thus we may have coupling from single tube to single tube,

from single tube to push-pull, from push-pull to push-pull, and push-pull to single tube. Tubes in parallel can be considered to be equivalent to one tube so far as drawing the circuit is concerned; in actual practice, however, parallel operation may call for modification of the coupling system.

**Capacitive Coupling**

● Capacitive coupling systems are probably the simplest of all and require the least amount of apparatus. Several systems are shown schematically in Fig. 814. The circuit at *A* is widely used; coupling is through condenser *C* from the plate tank of the driver to the grid of the amplifier. The plate of the driver is series fed; condenser *C* serves both to provide r.f. coupling and to insulate the grid of the amplifier tube from the d.c. plate voltage on the driver stage. Grid bias for the amplifier is supplied through an r.f. choke. Since the negative side of the driver plate supply and the positive side of the amplifier bias supply meet at the common filament connection between the two tubes, the coupling condenser *C* must have insulation good enough to stand the sum of these

two voltages without breakdown. The fact that the condenser also is carrying a considerable radio-frequency current makes it desirable that it have a voltage rating giving a factor of safety of at least 2 or 3.

Circuit *B* is practically equivalent to Circuit *A*; the coupling condenser has been moved to the plate circuit of the driver tube and the radio-frequency choke appears at the plate of the driver. This simply shifts the driver to parallel plate feed, and permits the use of series feed to the amplifier grid. In both circuits the excitation can be controlled by moving the tap on the tank coil; the nearer the tap is to the plate end of the coil the greater will be the excitation voltage up to the limit of the driver output.

These circuits have the advantage of simplicity, but have the disadvantage that the interelectrode capacities of both the driver and amplifier tubes are connected across the tuned circuit, thus necessitating a reduction in the *L-C* ratio of the driver tank circuit and reducing the efficiency at the very high frequencies. They operate quite satisfactorily with ordinary tubes at frequencies of 7 mc. and

lower, and at 14 mc. with tubes having low interelectrode capacities, such as the 852, 800, 50T, 150T, RK18 and others with comparable capacities. The variable tap for regulating excitation is sometimes responsible for parasitic oscillation in the amplifier, a condition which is harmful to the efficiency.

The effect of paralleling the input and output capacities of driver and amplifier tubes can be avoided by using circuits like those of Fig. 814-C and -D. Since the ground point is between the two ends of the tank, the tank is "hot" on both ends. The amplifier is coupled from the end opposite the plate of the driver, hence its input capacity is across only part of the driver tank while the output capacity of the driver is across the other part. So far as tuning the driver tank is concerned, these two capacities are in series and the resultant capacity is less than that of either tube alone.

The difference between *C* and *D* is in the method of splitting the tank circuit. In *C* excitation can be adjusted by moving the ground tap on the coil, while in *D* excitation is adjusted by varying the relative capacities of *C*<sub>1</sub> and *C*<sub>2</sub>, keeping the total capacity constant to maintain resonance.

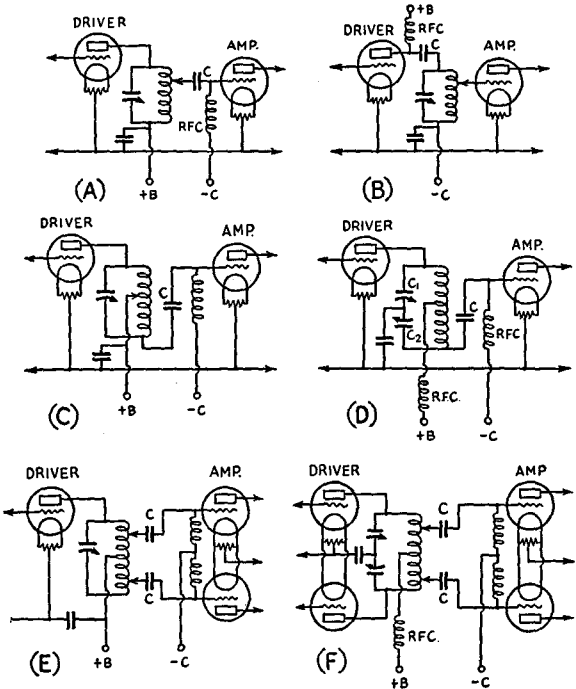

FIG. 814—DIRECT OR CAPACITY-COUPLED DRIVER AND AMPLIFIER STAGES

Coupling condenser capacity may be from 250  $\mu$ fd. to .002  $\mu$ fd., not critical, except under conditions described in the text.

# Principles of Transmitter Design and Operation

A balanced driver circuit also can be used for coupling to a following push-pull amplifier, as shown in Fig. 814-E. Since the center of a balanced circuit is at zero r.f. potential, there is a phase difference of 180 degrees between the ends of the tank, hence such a tank circuit is suitable for exciting a push-pull amplifier. Excitation can be regulated by adjusting the taps on the tank coil, keeping them equidistant from the center-tap to maintain the balance. A split-stator condenser can be used to balance the circuit, replacing the center-tap on the coil, if desired.

The use of capacity coupling between push-pull stages is shown in Fig. 814-F. The taps are equidistant from the center in this circuit also.

## Capacity-Coupling Considerations

● When an r.f. amplifier is operated at high efficiency its grid or input circuit consumes power, which must be furnished by the driver. Since power is consumed, the grid circuit of the amplifier has a definite impedance (*input impedance*), which may be high or low according to the type of tube used. A high- $\mu$  tube usually will have low input impedance, because grid current starts to flow at relatively low exciting voltages. Conversely, a low- $\mu$  tube will have relatively high impedance, because a considerably larger r.f. exciting voltage is required for the same grid-current flow. If the driver is to work at optimum efficiency the impedance represented by its loaded tank circuit must lie within definite limits, which may or may not be near in value to the grid impedance of the following stage. The coupling system must transform the grid impedance of the amplifier to a value suitable for loading the driver tube.

With capacity-coupling systems this impedance "matching" is effected by adjusting the position of the excitation tap on the tank coil. The higher the optimum driver load impedance and the lower the amplifier grid input impedance, the nearer the excitation tap will be to the ground point on the tank coil. Conversely, with relatively low driver load resistance and high amplifier grid impedance, the tap will be nearer the high-potential end of the coil. The object, of course, is to deliver as much power as possible to the grid circuit of the amplifier.

While a satisfactory coupling value usually can be obtained without much difficulty, the tap on the coil often introduces a circuit difficulty in that the turns included between tap and ground end of the coil may cause parasitic oscillations (discussed in a later section) which impair the operation of the ampli-

fier. For this reason it may be necessary to couple directly from the end of the tank, in which case overloading of the driver can be prevented only by the use of a very small coupling condenser, preferably variable for adjustment purposes. This reduces the coupling efficiency.

## Inductive Coupling

● Many of the disadvantages of capacity coupling can be overcome by the use of inductive

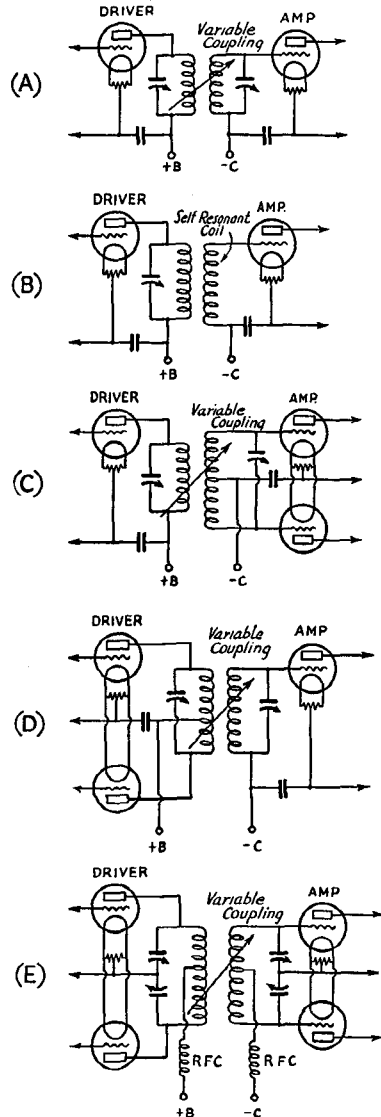

FIG. 815—INDUCTIVE INTERSTAGE COUPLING

tive coupling between stages, several typical circuits being shown in Fig. 815. Inductive coupling requires separate tank circuits for the plate of the driver and grid of the ampli-

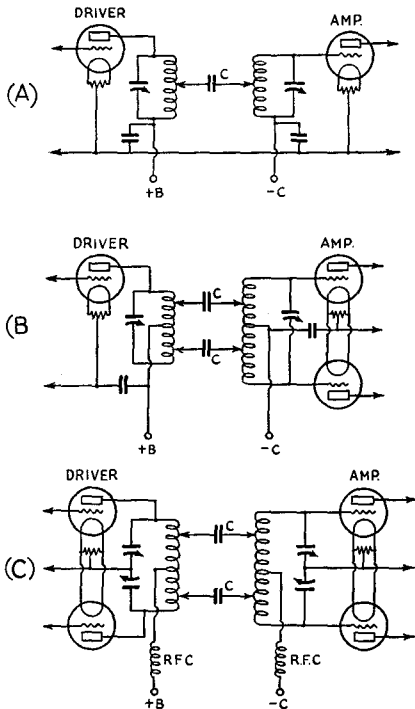

FIG. 816 — TRANSMISSION-LINE OR "MATCHED IMPEDANCE" COUPLING

fier and also a means for varying the coupling between them. The two circuits are tuned to the same frequency, regardless of whether the amplifier is a straight amplifier or doubler.

Excitation can be adjusted by varying the coupling between the two tank coils, the circuits being kept tuned to resonance as the coupling is varied.

For simplification a self-resonant coil may be used in the grid circuit of the amplifier. When this is done, the grid coil usually is wound on the same form as the driver tank coil, the coupling thus being fixed. The number of turns is then adjusted to give maximum power transfer to the amplifier grid circuit. The coil should resonate at a frequency somewhat lower than the operating frequency if very close coupling is used. The self-resonant or untuned grid coil will work over a fair range of frequency without readjustment, although there is likely to be some loss of excitation if one

coil is used to cover a band as wide as the 3500-4000 kc. band.

Inductive circuits for coupling single-ended to push-pull amplifiers and vice versa, as well as push-pull to push-pull, also are shown. The untuned grid coil arrangement also may be used in these circuits. The operating principles and method of adjusting excitation are the same.

Inductive coupling provides smooth adjustment of excitation and driver loading and is an excellent system for use at the higher amateur frequencies. The chief disadvantage is the necessity for providing a mechanical means for varying the coupling between plate and grid tank circuits.

**Transmission Line or Link Coupling**

● The advantages of separately-tuned plate and grid tanks for driver and amplifier can be retained without the necessity for providing inductive coupling between the stages by the use of a transmission line terminating at the two tanks. The form of transmission-line coupling utilizing a low-impedance line (such as a twisted pair) with coupling loops of a turn or two at each end is popularly known as

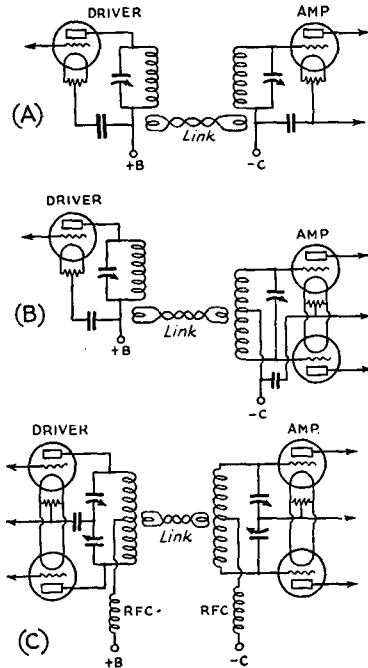

FIG. 817 — LINK COUPLING, USING A LOW-IMPEDANCE TRANSMISSION LINE

*These circuits belong to the same family as those of Fig. 816.*



# Principles of Transmitter Design and Operation

“link” coupling. The transmission line may be of any convenient length — from a few inches to several feet — without appreciable loss of power in the transfer. This is a highly convenient feature if, as in some layouts, the amplifier must be located at a distance from the driver.

Several forms of transmission-line coupling are shown in Figs. 816 and 817. In the direct-coupled circuits of Fig. 816 the excitation is adjusted by varying the positions of the taps on the two tank coils, the object being to obtain the maximum r.f. power at the grid of the amplifier without overloading the driver. The farther the taps from the ground ends of the coils the greater the loading on the driver. Moving the taps up from ground also will increase the excitation until the limit of driver output is reached.

In the circuit of Fig. 816-A, one side of the coupling line is the cathode connection between the two stages. For this reason the distance between stages should not be too great because there is an r.f. drop in the line, thus putting the cathode circuits of the two stages at different r.f. potentials. In circuits B and C the length of line is immaterial, since two wires are used and no current flows in the common cathode connection. The condensers marked *C* are for insulation purposes; their capacity is not critical but should be of the order of .002  $\mu$ f.

If a balanced line of the type shown in Fig. 816-B and C is run for a distance of more than a foot or two, it should be uniformly spaced throughout its entire length.

## Link-Coupled Circuits

● Circuits for a low-impedance line, usually twisted pair, are shown in Fig. 817. The principle of operation is the same as with the direct-coupled lines except that inductive coupling usually is provided between the line and the tuned circuits. This coupling ordinarily is by a turn or two of wire, its ends connected to the twisted pair, closely coupled to the tank inductance. Because of the low impedance of the line, one turn often suffices if the coupling is tight enough. However, sometimes more than one is needed for maximum power transfer. The link should preferably be coupled to the tank circuits at a point of low r.f. potential, as indicated in the diagrams. It is also advisable, especially with high-power stages, to have some means of varying the coupling between link and tank coil. The link turn may be arranged to be swung in relation to the tank coil or, when it consists of a large turn around the outside of the tank coil, can be split into two parts

which can be pulled apart or closed somewhat in the fashion of a pair of calipers. If the tank coils are wound on forms, the link may be a single turn wound close to the main coil.

With fixed coupling, the only adjustment of excitation is by varying the number of turns on the link. If the coupling between link and tank is variable, change of physical separation of the two coils also will give some adjustment of excitation. In general the proper number of turns for the link must be found by experiment.

Properly-adjusted transmission line coupling causes no increase in the capacities shunting the tank circuits. This type of coupling is therefore especially advantageous at the higher frequencies.

## Neutralizing

● As we have already explained, a three-electrode tube used as a straight radio-frequency amplifier will oscillate because of radio-frequency feed-back through the grid-plate capacity of the tube unless that feed-back is nullified. The process of neutralization really amounts to taking some of the radio-frequency voltage from the output or input circuit of the amplifier and introducing it into the other circuit in such a way that it effectively “bucks” the voltage operating through the grid-plate capacity of the tube, thus rendering it impossible for the tube to supply its own excitation. For complete neutralization it is necessary, therefore, that the neutralizing voltage be opposite in phase to the voltage through the grid-plate capacity of the tube and be equal to it in value.

The out-of-phase voltage can be obtained quite readily by using a balanced tank circuit in either grid or plate, taking the neutralizing voltage from the end of the tank opposite that to which the grid or plate is connected. The amplitude of the neutralizing voltage can be regulated by means of a small condenser, the “neutralizing condenser,” having the same order of capacity as the grid-plate capacity of the tube. Circuits in which the neutralizing voltage is obtained from a balanced grid tank and fed to the plate through the neutralizing condenser may be called “grid-neutralizing” circuits, while if the neutralizing voltage is obtained from a balanced plate tank and fed to the grid of the tube, the circuit is known as a “plate-neutralized” circuit.

A neutralizing circuit is actually a form of bridge circuit, the grid-plate capacity of the tube and the neutralizing condenser forming two capacitive arms, while the halves of the balanced tank circuit form the other two arms.

## Plate-Neutralizing Circuits

● Several plate-neutralizing circuits are given in Fig. 818. In the circuit shown at A the tank coil is center-tapped, with the tank condenser connected across only the upper half of the

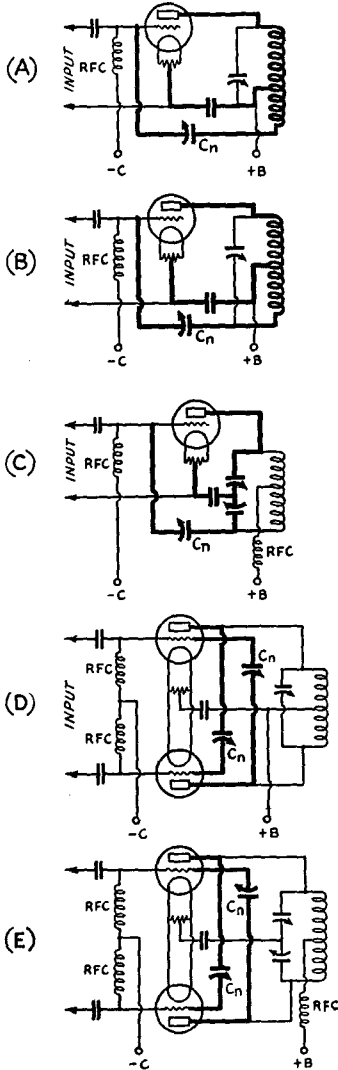

FIG. 818 — PLATE NEUTRALIZING CIRCUITS

coil. The neutralizing portion of the coil is connected back to the grid of the tube through the neutralizing condenser,  $C_n$ . The circuit of B is similar, differing, however, in that the tank condenser is connected across all of the tank coil. This method of connection is prefer-

able in that it tends to keep a better voltage balance over a range of frequencies. The only reason for using the circuit of A is to get as high impedance as possible in the part of the tank circuit included between the filament return and plate for the sake of efficiency.

In both the circuits already described the division of r.f. voltage between plate and neutralizing portions of the circuit has been by balancing the tank coil. The balance also can be capacitive, by the use of a split-stator tank condenser with grounded rotor, as shown in Fig. 818-C. The r.f. potential across the tank coil divides in the same way, a node (point of zero voltage) appearing at its center. Hence the plate voltage is introduced at the center of the coil. The r.f. choke in the plate voltage lead is for the purpose of isolating the center of the coil from ground for r.f., since a ground through a by-pass condenser, if not exactly at the point of zero potential, might cause circulating currents which would reduce the plate efficiency of the amplifier.

The push-pull neutralizing circuits shown at D and E are known as "cross-neutralized" circuits, the neutralizing condensers being cross-connected from grid of one tube to plate of the other. With proper physical arrangement of parts, a more exact balance can be obtained with push-pull than with a single tube because both sides of the circuit are symmetrical. Hence these circuits often are easier to neutralize than single-tube circuits. The split condenser circuit of E is to be preferred for push-pull amplifiers.

## Grid Neutralization

● Typical grid-neutralizing circuits are shown in Fig. 819. They resemble closely the plate-neutralizing circuits except that the neutralizing voltage is obtained from a balanced input tank and fed to the plate of the tube. Circuit A is used with capacity coupling between driver and amplifier. The grid coupling condenser, being large in comparison to the tube and neutralizing capacities in most circuits, will have negligible effect on the operation of the neutralizing circuit.

Grid neutralizing systems are well adapted to use with transmission line or link-coupled amplifiers, since the separate grid tank offers a ready means for obtaining the neutralizing voltage. It may be somewhat harder to drive a tube with a balanced input tank, however, because only half the r.f. voltage developed in the tank is available for the grid-cathode circuit of the amplifier. This can be overcome to some extent by using the largest possible  $L-C$  ratio in the grid tank in order to build up the

# Principles of Transmitter Design and Operation

r.f. voltage to the highest possible value. An advantage of the grid-neutralizing systems is the fact that the single-ended plate tank circuit has higher impedance, and hence gives greater plate efficiency, than a balanced plate tank in which the plate-cathode circuit is connected across only half the turns or half the capacity.

## Values in Neutralizing Circuits

● In all these circuits, by-pass condensers and parts not particularly a part of the neutralizing arrangement will have the usual values. In most cases the neutralizing voltage will be equal to the r.f. voltage between the plate and grid of the tube so that for perfect balance the capacity required in the neutralizing condenser theoretically will be equal to the grid-plate capacity of the tube being neutralized. If, in the circuits having tapped tank coils, the tap is more than half the total number of turns from the plate end of the coil, the required neutralizing capacity will increase approximately in proportion to the relative number of turns in the two sections of the coil.

The paragraph above should make it clear that the neutralizing capacity required at  $C_n$  will depend upon the type of tube and the choice of circuit. For those tubes having grid and plate connections brought out through the bulb, such as the 800, 852, 50T, 150T and a few others, a condenser having at about half scale a capacity equal to the grid-plate capacity of the tube should be chosen. Where the grid and plate leads are brought through a common base, the  $C_n$  capacity needed is greater because the tube socket and its associated wiring adds some capacity to the actual inter-element capacities. In such cases a slightly larger condenser should be used. For most small triodes, a condenser having a minimum of about 5  $\mu\text{fd.}$  and a maximum of approximately 20  $\mu\text{fd.}$  will suffice. Such condensers are readily obtainable in the midget sizes.

When two or more tubes are connected in parallel, the neutralizing capacity required will be in proportion to the number of tubes.

## Comparison of Neutralizing Circuits

● Aside from the considerations already mentioned in the discussion of neutralizing circuits there are certain practical aspects of neutralizing which should be kept in mind in deciding what type of circuit to employ. These apply particularly in neutralized single-ended stages.

The most commonly-used circuits are those given in Fig. 818 at *B* and *C*. The split-coil method at *B*, despite apparently perfect neutralization when the general method to be

described in the next section is followed, usually will have a tendency to oscillate near the operating frequency if the tube is biased so that it draws appreciable plate current with no excitation. This tendency causes regeneration when the amplifier is operating, which, while usually giving rise to no bad effects in c.w. work, may cause the output characteristic to be non-linear when the amplifier is modulated. Complete neutralization can be obtained at only one frequency with this circuit in a single-ended amplifier, because the various stray capacities shunting the coil destroy the balance when the circuit is detuned slightly. Providing the regeneration mentioned above is acceptable, however, the unbalance is small enough so that satisfactory performance can be obtained.

The balanced condenser arrangement at *C* gives more complete neutralization and lacks regeneration. This circuit also is likely to go out of balance with tuning, however, if the plate-filament capacity of the tube is appreciable with respect to the capacity of the condenser section connected across it. At the higher amateur frequencies, therefore, the cir-

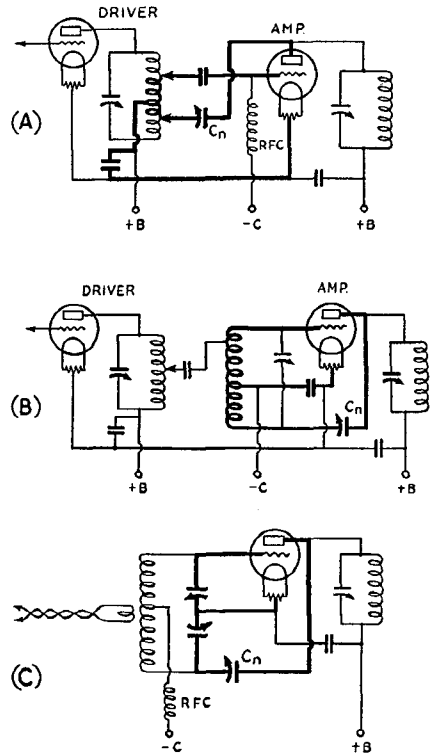

FIG. 819 — GRID NEUTRALIZING CIRCUITS

circuit functions best with a tube having low output capacity, and with a split-stator condenser having moderately large "in-use" capacity in each section. The effect of the tube output capacity can be eliminated by connecting a small condenser across the opposite condenser section to simulate a second tube balancing the first. The additional condenser should be adjusted to equal the effective output capacity of the tube.

The split condenser circuit has two advantages over the split coil: the effective input capacity of the circuit is smaller, permitting an increase in the  $L-C$  ratio of the grid tank circuit, and harmonics are more effectively suppressed because the condenser section between plate and filament offers much lower impedance to harmonics than the upper coil section in the circuit of *B*. The lack of regeneration in the split-condenser circuit may cause an amplifier neutralized by this method to appear harder to drive than when the split-coil system is used, especially if the driver power output is low, because the regenerative effect of the latter system tends to maintain the grid current at a higher value under load. Comparisons of the two circuits in a properly designed transmitter, however, show that with moderate excitation the same output can be obtained with either despite the difference in behavior of grid currents; the split-condenser circuit often, in fact, shows better plate efficiency, probably because more of the power output is on the fundamental frequency and less on harmonics.

Aside from regenerative effects, which usually are unwanted in neutralized circuits, the driving power required is in no way related to the neutralizing system, being purely a function of the type of tube used, the plate load resistance, and grid bias.

**Neutralizing Adjustments**

● The procedure in neutralizing is the same regardless of the tube or circuit used. The first step in neutralizing is to disconnect the plate-voltage from the tube. Its filament should be lighted, however, and the excitation from the

preceding stage should be fed to its grid circuit. Couple any r.f. indicator such as a neon bulb or a flashlight lamp connected to a loop of wire to the plate tank circuit (if a neon bulb is used, simply touch the metal base to the plate terminal) and tune the plate circuit to resonance, which will be indicated by a maximum reading of the r.f. indicator. Then, leaving the plate tank condenser alone, find the setting of the neutralizing condenser which makes the r.f. in the plate tank drop to zero. Turning the neutralizing condenser probably will throw off the tuning of the driver tank slightly, so the preceding stage should be retuned to resonance.

Now couple the r.f. indicator to the plate tank once more and again tune the plate circuit to resonance. Probably the resonance point will occur at a slightly different setting, and the second reading on the r.f. indicator will be lower than the first one. Retune the preceding stage once more and go through the whole procedure again. Continue until the r.f. indicator gives no reading when the plate tank circuit is tuned in the region of resonance. When this has been accomplished the tube is neutralized.

The aim of neutralizing adjustments is to find the setting of the neutralizing condenser which eliminates r.f. in the plate circuit when the plate circuit is tuned to resonance. It is not at all difficult to neutralize a tube after a few practice trials, provided the circuit is laid out properly and provided the neutralizing condenser has the right capacity range. It sometimes happens that while a setting of the neutralizing condenser can be found which gives a definite point of minimum r.f. in the plate circuit, the r.f. is not completely eliminated; in such a case stray coupling between the amplifier and driver tank coils, or stray capacities between various parts of the amplifier circuit tending to upset the voltage balance, probably will be found to be responsible. A better layout with short, widely-spaced leads, or with coils so placed that coupling between them is minimized — usually when the axes of

the coils are at right angles — should be tried. Shielding of the amplifier often will eliminate troubles of this sort.

**Neutralizing Indicators**

● In the neutralizing procedure outlined above, the use of a neon bulb or other r.f. indicator has been assumed. In circuits in which the neutralizing bridge is entirely capacitive,

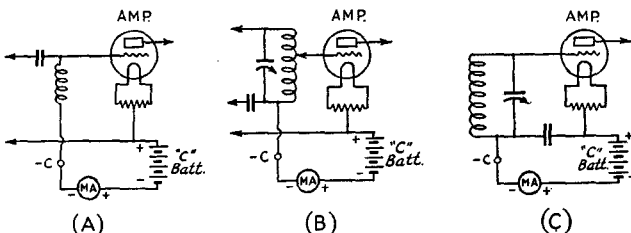

FIG. 820.—METHODS OF CONNECTING A MILLIAMMETER IN THE GRID RETURN LEAD TO MEASURE RECTIFIED GRID CURRENT

# Principles of Transmitter Design and Operation

as in those circuits using split-stator condensers, touching the neon bulb to a high-potential point of the circuit may introduce enough stray capacity to unbalance the circuit slightly, thus upsetting the neutralizing. This is particularly noticeable with high-power amplifiers, where the excitation voltage is considerable and a slight unbalance gives a noticeable indication. In such cases a flashlight lamp and loop of wire, tightly coupled to the tank coil, may give a more accurate indication of the exact neutralizing point. A thermo-galvanometer similarly connected to a wire loop has considerably greater sensitivity, but is expensive.

A d.c. milliammeter connected to read rectified grid current makes a quite sensitive neutralizing indicator. If the circuit is not completely neutralized, tuning the plate tank circuit through resonance will change the tuning of the grid circuit and affect its loading, causing a change in the d.c. grid current. With push-pull amplifiers, or single-ended amplifiers using a tap on the tank coil for neutralization, the setting of the neutralizing condenser which

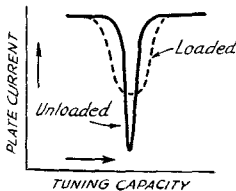

FIG. 821 — TYPICAL BEHAVIOR OF D.C. PLATE CURRENT WITH TUNING OF AN AMPLIFIER

leaves the grid current unaffected as the plate tank is tuned through resonance is the correct one. If the circuit is slightly out of neutralization the grid meter needle will give a noticeable flicker. With single-ended circuits having split-stator neutralization the behavior of the grid meter will depend upon the type of tube used. If the tube's output capacity is not great enough to upset the balance, the action of the meter will be the same as in other circuits. With high-capacity tubes, however, the meter usually will show a gradual rise and fall as the plate tank is tuned through resonance, reaching a maximum right at resonance when the circuit is properly neutralized. A sharp flicker at resonance indicates that the circuit is not neutralized.

## Tuning an Amplifier

● Amplifier tuning is quite simple, and the adjustments are similar regardless of the type of circuit used. It is also immaterial whether the tube is a neutralized triode or a screen-grid

tube requiring no neutralization. In describing the process, however, it will be assumed that the neutralizing, if required, has been carried through to a satisfactory conclusion. A tube which is not properly neutralized is likely to behave erratically when plate voltage is applied.

Before applying plate voltage to the amplifier, the plate circuit of the preceding stage should be tuned to give maximum output. Perhaps the most satisfactory indicator of the excitation power delivered by the driver stage is a d.c. milliammeter connected in series with the grid return circuit of the amplifier. The higher the rectified grid current indicated by such a meter, the greater is the excitation. The method of connecting the meter will depend upon the type of grid circuit used; Fig. 820 gives some examples. The connections at A would be used with amplifier grid circuits like those in Fig. 814-A, C, D, E and F; those at B with Fig. 814-B; and those at C with Figs. 815, 816 and 817. The method of connecting the grid meter in the push-pull circuits is obvious from inspection of Fig. 820. The plus and minus signs indicate the proper way to connect the meter in the circuit.

The first step is to adjust the driver stage tuning for maximum amplifier grid current. Then the coupling between the stages should be adjusted to give a further increase, if possible. Methods of varying the coupling have been indicated in the discussion of the various coupling systems. The driver circuit should be retuned to resonance every time the coupling is changed, no matter what the coupling system used, since a change in coupling is likely to throw the tank circuit slightly off tune. If there is a tank circuit in the grid of the amplifier, as in Figs. 815, 816 and 817, it too should be retuned for the same reason. A few minutes spent in changing coupling and readjusting tuning should show quickly the optimum coupling for maximum grid current.

Once the proper grid-coupling adjustment has been found, the amplifier plate tank condenser should be set approximately at resonance. With the excitation connected, the plate voltage may then be applied and the plate tank circuit tuned to resonance, which will be indicated by a very pronounced dip in plate current. This adjustment should be made quickly, since the tube filament will be damaged by continued application of plate voltage with the tank circuit tuned off resonance. (In preliminary adjustments it is a good idea to use low plate voltage until the amplifier is properly tuned.) The off-resonance plate current usually will be considerably higher than the rated plate current for the tube — sometimes sev-

eral times as great — but at resonance should drop to ten or twenty percent of the rated value. The higher the excitation power and the higher the  $L-C$  ratio in the amplifier plate tank circuit, the greater will be the dip in plate current at resonance. If the dip in plate current is not very pronounced, the excitation

terions", however, because they are prone to be misleading. The minimum plate current will decrease with an increase in  $L-C$  ratio, but it does not follow that the plate efficiency will be better, especially after the optimum  $L-C$  ratio is passed. Likewise, both minimum and off-resonance plate current depend upon the biasing method used, as well as upon the excitation voltage. The only way to gauge accurately the performance is to measure the output of the amplifier and calculate the plate efficiency. Identical plate efficiencies can be obtained with considerably different values of minimum plate current, even though the excitation power be unchanged.

When the tuning process has been carried this far, the output load circuit may be connected to the amplifier. This load circuit may be the antenna itself, through the coupling apparatus, or the grid circuit of a following amplifier. When the load is connected the amplifier plate current will rise. The plate tank circuit should be returned for minimum plate current — this "minimum," however, will no longer be the low value obtained at no load but a new value nearer the rated plate current of the tube — since connecting the load probably will detune the tank circuit to some extent. The coupling to the load circuit should be adjusted so that the new minimum plate current value is approximately the rated plate current of the tube. Fig. 821 shows typical behavior of plate current with tank tuning and loading. If the load is an antenna circuit, the methods of adjusting coupling outlined later in this chapter should be followed; if another amplifier, the coupling may be adjusted as already described. In the preliminary tuning of an amplifier it is often desirable to use a lamp bulb of suitable power rating, connected across a few turns of the plate tank coil, as a dummy load. The lamp will give some indication of the actual power output of the amplifier.

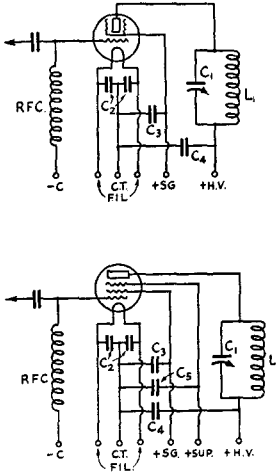

FIG. 822 — TYPICAL SCREEN-GRID AMPLIFIER CIRCUITS

The upper diagram is used with filament-type screen-grid power tubes such as the 865, 860, 282-A, 850, 254-A and 254-B. Important points to observe in the operation of the screen-grid amplifier are that the screen bypass condenser,  $C_3$ , should have low impedance at the operating frequency (capacity of at least .002  $\mu$ f. for amateur transmitters) and that the output tank circuit  $L_1C_1$  must be isolated from the input circuit, either by shielding or by physical spacing great enough to prevent feedback. Bypass condensers  $C_2$  and  $C_4$  may be the usual values used in power-tube circuits; .002  $\mu$ f. will be sufficient. Any type of input coupling may be used in place of the capacity coupling shown.

The lower diagram is for use with screen-grid pentodes. It is essentially the same as the upper circuit except for the additional connections for the suppressor grid, which should be supplied a small positive voltage for maximum output. Values are the same for similarly-labelled components in both circuits.  $C_5$  should have the same value as  $C_3$ .

may be low or the tube may not be properly neutralized, if a triode.

Some amateurs, as a rule of thumb procedure, judge the efficiency of an amplifier by the value of minimum plate current with the plate circuit unloaded, on the theory that the lower this value the greater the proportion of plate current effective in producing output when the amplifier is loaded. Similarly, the off-resonance plate current is often taken as a measure of the excitation. Too much dependence should not be placed on these "cri-

### Screen-Grid Amplifiers

- The general principles of amplifier operation apply equally well to screen grid tubes as to triodes. Since neutralization is not required, the circuits of screen-grid amplifiers are relatively simple. Typical circuits for tetrodes and pentodes are given in Fig. 822.

The rules for interstage coupling also are applicable to these circuits. Chief points about the screen-grid amplifier are the necessity for thorough grounding of screen (and suppressor) for r.f. through the use of bypass condensers close to the tube itself, and the prevention of stray couplings between input and output

# Principles of Transmitter Design and Operation

circuits. Although the tubes are shielded from internal feedback, self-oscillation through feedback external to the tube is possible if these two circuits are not isolated from each other. Complete shielding is advisable, although not always absolutely necessary, with the screen-grid amplifier.

Tuning adjustments are carried out in the same way as with triodes. The power output is considerably affected by the d.c. potentials on screen and suppressor; adjustment of these voltages after the circuit has been tuned may result in a further increase in power output. Care should be taken, however, to see that the rated screen dissipation, listed in the table in Chapter Five, is not exceeded.

Screen-grid pentodes have high power sensitivity and usually require much less grid driving power for full output than does a triode of comparable ratings.

The higher power sensitivity, however, makes pentodes (especially the smaller sizes) more prone to self-oscillate than tetrodes, so that particular care must be used to prevent feedback external to the tube itself. In cases where low-loss circuits are used, it may be impossible to prevent oscillation unless the input and output circuits are carefully shielded from each other, and the input circuit shielded from the tube itself.

## Frequency Multipliers

● Since at the present time the most popular crystals are those ground for the lower amateur frequencies — 1.75, 3.5 and 7 megacycles — it becomes necessary to resort to other means than straight amplification to obtain crystal-controlled output on the higher-frequency bands. Many amateurs make a practice of operating in three or more bands with only one crystal, usually one having a frequency toward the lower end of the 3.5-mc. band so that its harmonics will fall in the higher-frequency bands. To do this it is necessary to use harmonic generators or *frequency multipliers*. The frequency multiplier is simply a straight amplifier whose plate circuit is tuned to a multiple of the driving frequency, operated under conditions which produce relatively high harmonic output. Since its input and output circuits are not tuned to the same frequency it cannot self-oscillate, hence a triode frequency multiplier does not need neutralization. The plate efficiency of a frequency multiplier is considerably less than that of a straight amplifier, and decreases rapidly when the plate circuit is tuned to a harmonic higher than the second. For this reason most frequency multipliers are designed to give output only on the

second harmonic; since the frequency is doubled the tube is appropriately called a "doubler."

## Doubler Operating Conditions

● To obtain maximum output and efficiency from the doubler it is necessary to use high negative grid bias on the tube — considerably more than double cut-off — and excite it with a correspondingly high radio-frequency voltage. This accentuates harmonic generation in the plate circuit, as explained in Chapter Five. A low-*C* tank in the plate circuit is also desirable. In general, a tube having a relatively large amplification factor is to be preferred as a doubler because relatively low bias and excitation voltage will give high distortion. Tubes such as the 46 and 59 with Class-B connections, the 841, RK18, 800, 35T, 838 and 203-A are most suitable. Other types, such as the 10, 801 and 211, will work satisfactorily but require higher bias and greater excitation voltage than the high- $\mu$  tubes.

The efficiency and output of a doubler can be increased by feeding some of the energy in the plate circuit back to the grid to cause regeneration, provided the process is not carried so far that the tube breaks into self-oscillation. One of the most satisfactory ways of introducing regeneration is through neutralizing the frequency multiplier by one of the methods in which the neutralizing voltage is fed from the plate circuit to the grid. The single-tube circuits of Fig. 818 are examples. When the tube is properly neutralized it cannot oscillate, yet the feedback at the harmonic frequency is sufficient to increase the output and efficiency of the doubler to a worth-while extent.

Almost any single-ended amplifier — single tube, or tubes in parallel — will operate as a doubler if the plate circuit is tuned to the second harmonic of the driver frequency. The bias voltage should be raised either by adding more battery voltage or by using a higher resistance grid leak. The grid leak for a doubler may in general have a resistance from two to five times that recommended for the tube as a straight amplifier. The driving power required for good doubling efficiency will be two or three times greater than that necessary for efficient straight amplification. A properly-operated doubler can give a power gain of about five, provided the tube is capable of handling the power. A small tube excited by one of similar ratings usually cannot give such a gain. At the higher frequencies — 14 and 28 mc. — small tubes used as doublers often do not give any power gain at all; the output on the second harmonic may be just about the

same as the output of the driver tube, or even less. This may be no particular disadvantage in some transmitter designs, as will be explained later.

Push-pull amplifiers cannot be used as doublers because the second and other even harmonics are cancelled in the output of such amplifiers. They can be used as triplers, however, the output circuit being tuned to the third harmonic. They are not very often used

in this way because both efficiency and output are low, and because the frequency relations of the amateur bands are such that even-harmonic output is necessary.

## Doubler Circuits

● The simple triode doubler circuit is shown in Fig. 823-A. Screen-grid or pentode doubler circuits are exactly the same as the straight amplifier diagrams given in Fig. 822. The plate tank is simply tuned to the second harmonic instead of the fundamental frequency. Neutralized circuits such as those in Fig. 818 also can be used.

Special circuits for frequency doubling also have been employed; one which is often used is shown in Fig. 823-B. In this circuit two tubes are used; the excitation is fed to the grids in push-pull while the plates of the tubes are connected in parallel. Thus the tubes work alternately, and the output circuit receives two impulses for each r.f. cycle at the grids, resulting in all second-harmonic output. This circuit gives quite good efficiency, although requiring two tubes. It is often called a "push-push" doubler. In low-power stages, twin triodes such as the 53 and 6A6 can be used as single-tube push-push doublers. The high amplification factors of these two types make them especially suitable for this purpose.

A regenerative circuit, especially suitable for indirectly-heated cathode tubes such as the 59, 2A5, etc., is shown at Fig. 823-C. It is really a controlled oscillator, its characteristics being such that it readily "locks in" with the frequency of the driving source when the plate circuit is tuned to the harmonic. The circuit may not actually oscillate at the lower frequencies, but enough regeneration is supplied to increase both the output and efficiency of the doubler.

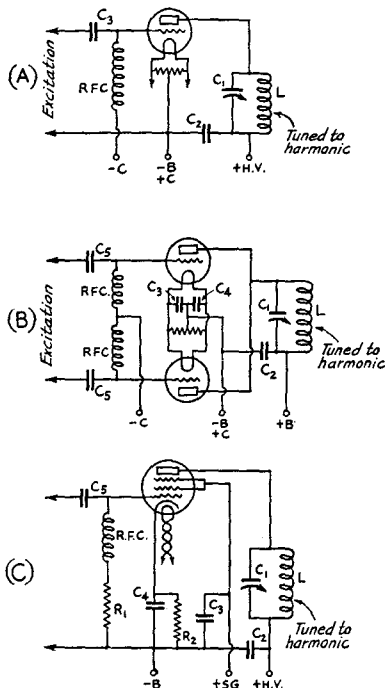

FIG. 823 — FREQUENCY MULTIPLYING CIRCUITS

The regular doubler circuit (A) is the simplest. The plate tuned circuit should be fairly low-C for best results; the capacity actually in use at  $C_1$  should not exceed 50  $\mu\text{fd.}$  at the lower amateur frequencies and 25  $\mu\text{fd.}$  at 14 mc. and higher.  $C_2$  is a plate bypass condenser having a capacity of about .002  $\mu\text{fd.}$  The capacity  $C_3$ , the grid coupling condenser, depends upon the type of tube; see the discussion on inter-stage coupling. Any of the recommended grid-coupling arrangements may be used instead of the simple capacity coupling shown.

Values in the "push-push" doubler (B) are in general identical with those in (A). This circuit requires push-pull input.

In the circuit at (C) tank circuit values should be the same as recommended above.  $C_2$  and  $C_3$  are the usual .002- $\mu\text{fd.}$  bypass condensers.  $C_4$ , which controls the regenerative effect, usually should be approximately 100  $\mu\text{fd.}$ ; so also should  $C_5$  with the tubes most likely to be used in this circuit, the 59, 2A5, and their 6-volt equivalents. Grid leak,  $R_1$ , should be 50,000 ohms and cathode resistor,  $R_2$ , 1000 ohms.

Suitable coil specifications for the capacity in use at  $C_1$  can be found by referring to the coil table.

## Tuning of Frequency Multipliers

● Frequency multipliers are tuned in much the same way as straight amplifiers. Once the bias or grid leak values are chosen, the input or grid circuit should be adjusted for maximum grid current just as with the straight amplifier. Then the plate voltage may be applied and the plate tank circuit tuned to the second harmonic, which will be indicated by the dip in plate current. The dip usually will not be as pronounced as with straight amplifiers, however. Once these adjustments have been made the load may be connected and adjusted for maximum output consistent with the plate current rating of the tube. Since the efficiency is lower, it may be necessary to use lower than rated plate current, especially if the plate of the tube shows color.



# Principles of Transmitter Design and Operation

After the adjustments have been completed it is a good plan to change the bias voltage or the resistance of the grid leak to find the value which gives greatest output. Since the optimum value will depend upon the type of tube used and the excitation available, it is not possible to give very definite specifications along these lines.

## Sources of Grid Bias

● It is necessary to make provision in the circuit for the application of proper negative grid bias voltage to the grid of the amplifier or doubler tube. The transmitting tube tables in Chapter Five indicate the value of grid bias which should be used under representative operating conditions for normal plate voltage. If the tube is operated at a plate voltage other than that indicated, the grid bias should be increased or decreased accordingly.

### Battery Bias

● Batteries have the advantage of giving practically constant voltage under all conditions of excitation or lack of it, although the grid current flow does have a charging effect which tends to raise the battery voltage. This effect increases as the batteries age and their internal resistance increases.

Besides the constant-voltage feature with varying grid currents, battery bias also protects the amplifier tube or tubes in case of excitation failure. This advantage is common to all fixed bias (as contrasted with biasing systems which depend upon the flow of grid current) systems. Should excitation stop with plate voltage applied, the plate current will drop to zero or a low value, depending upon whether the amplifier is biased beyond or near cut-off.

### Grid-Leak Bias

● Grid-leak bias is economical, since no expenditures for batteries is necessary, and has the desirable feature that the bias regulates itself in accordance with the amount of excitation available, thereby tending to give optimum amplifier operation under varying conditions of excitation. When there is no excitation at all, however, there is also no grid bias, and in the case of tubes operating at fairly high voltages, especially those having low and medium values of amplification factor, a large plate current will flow if the excitation should for any reason fail or be removed while the plate voltage is connected to the tube. This

may seriously damage the tube and possibly ruin it if not corrected in time.

The advantages of battery and grid-leak bias can be secured and their disadvantages eliminated by using a combination of both. Many amateurs use just enough battery bias to reduce the amplifier plate current to a safe value should excitation fail, and connect in series with the battery a grid leak to obtain the additional bias needed under operating conditions. In general, the leak values recommended in the tube table may be used without change when used in conjunction with a small amount of "safeguarding" battery bias.

When grid-leak bias is used the bias under operating conditions may be calculated by multiplying the leak resistance by the grid current in amperes ( $\text{ma.} \div 1000$ ). If a battery is in series with the leak, the battery voltage should be added to the voltage obtained by the calculation.

### Bias Power Packs

● A "B" eliminator or power pack similar to those used in receivers makes a satisfactory bias supply for most types of amplifier service. Such a supply gives the same advantages as the battery-grid leak combination, giving protective fixed bias in case of excitation failure and also some measure of self-regulation because of the voltage drop due to grid current flow through the bleeder resistor across its output. Special features of the design of bias supplies of this type are treated in Chapter Fifteen.

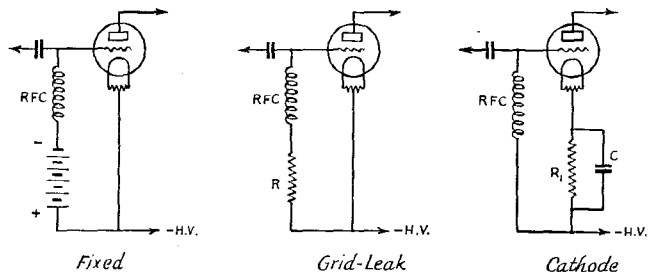

FIG. 824 — AMPLIFIER BIASING METHODS

A "B" eliminator or "C" power pack can be substituted for the battery provided its bleeder resistance is not too high. See Chapter Fifteen for information on the design of "C" power packs.

### Cathode Biasing

● Transmitting tubes also may be biased by the method universally used in receivers — by inserting a resistor of suitable value in series with the cathode or filament and using the voltage drop resulting from the flow of plate current through the resistor as bias. Correctly

applied, this method of biasing combines the self-adjusting features of grid leak bias with some measure of protection to the tube in case of excitation failure. The voltage drop in the biasing resistor causes a reduction in plate voltage by the same amount, however, so that the plate supply should be designed to have a terminal voltage equal to the desired operating plate voltage plus the grid bias voltage. For a tube intended to be operated with 1000 volts on the plate and 200 volts negative bias, for example, the plate supply voltage should be 1200 volts.

The value of the biasing resistor,  $R_1$  in Fig. 824, should be calculated for normal operation. For example, if the tube is rated to draw 130 ma. plate current and 20 ma. grid current, and

requires 150 volts grid bias, the resistance required will be

$$R = \frac{E}{I} = \frac{150}{0.15} = 1000 \text{ ohms.}$$

The plate current that will flow with no excitation can be found by cut-and-try methods from the tube's characteristic curves. Assume some value of plate current, calculate the bias resulting, and then check with the curves to see if that particular bias value will cause the assumed plate current to flow, keeping in mind the reduction in plate voltage due to bias. A few trials should give an approximate result. The power input should then be figured to make sure it is below the safe plate dissipation rating of the tube.

## Miscellany

### Coupling to the Antenna

● Although the antenna-coupling arrangement usually is an integral part of the transmitter, the choice of method and the adjustment procedure to be followed is so greatly a function of the antenna or feeder system employed that antenna-coupling methods are more logically treated in connection with the discussion of each particular antenna system. Information on coupling and tuning procedure is therefore given in Chapter Sixteen.

### Band-Switching

● For the sake of convenience in changing bands many amateurs are turning to band-switching in transmitters. This not only is an operating convenience, but also avoids the necessity for having a large number of plug-in coils on hand.

The chief requirement of a good band-changing scheme is that the plate circuit shall be switched to the proper band without the introduction of undue losses in the tank circuit. Two practicable methods are shown in Fig. 825. At A, a separate tank circuit is used for each band to be covered; the switch simply selects the one desired. If the switch has low capacity between points, this system will give good efficiency, since each tank circuit can be designed for optimum results. The chief disadvantage is the necessity for providing a separate tank condenser and coil for each band, which may be a considerable expense in a high-power stage. If the amplifier is an output stage, separate coupling coils, if used, can be coupled to each tank and switched in similar fashion, or coupling taps on the various tank coils can be selected.

In the system shown at B, the inductance of

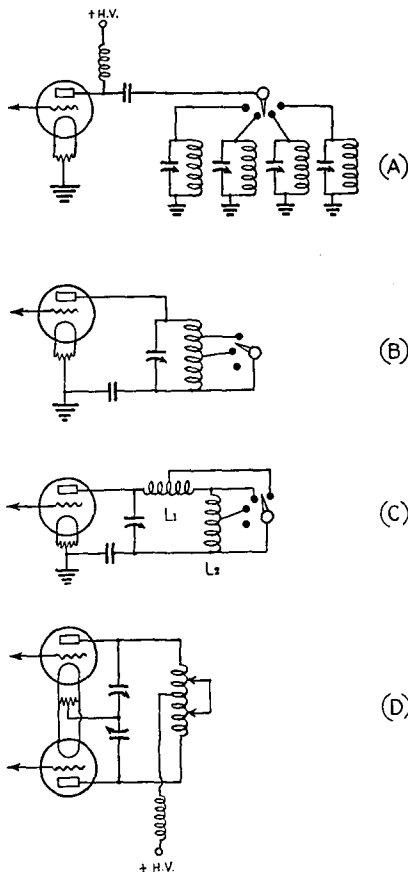

FIG. 825—METHODS OF SWITCHING THE AMPLIFIER PLATE TANK CIRCUIT FOR CHANGING BANDS

*Band-switching methods are most suited to screen-grid or pentode amplifiers because the complications involved in switching neutralized circuits are avoided.*

# Principles of Transmitter Design and Operation

the tank coil is changed to a suitable value for each band by shorting out a portion of the coil. Thus only one tuning condenser is needed. The coil should be designed for the lowest-frequency band to be covered, the positions of the taps for the higher frequencies being found by experiment.

Since the shorted-out portion of the coil is very closely coupled to the active section, the voltage induced in the shorted section is considerable and an r.f. current of some magnitude will flow. If the resistance of the shorted section is low, the losses caused by this circulating current will likewise be low. It is necessary also to use a switch or other shorting device having low contact resistance to keep down the losses.

If more than three bands are to be covered, it is better to arrange the coil in two sections, as shown in Fig. 825-C. In this case the coil  $L_1$  is designed for optimum inductance at the second from highest-frequency band to be covered; the inductance of  $L_2$  is then made such that the two in series will give optimum inductance for the lowest-frequency band. For example, if the amplifier is to cover the four bands 3.5, 7, 14 and 28 mc.,  $L_1$  would be designed for 14 mc., while  $L_2$  plus  $L_1$  would give optimum inductance at 3.5 mc. The taps then can be set for the other two bands. The two coils should be arranged so that there is no inductive coupling between them, thus avoiding the loss that would be introduced at the higher frequencies if all shorting were done on a single coil.

The method shown at 825-C also can be used for covering five bands if  $L_2$  is made large enough to resonate with the tank condenser to 1.75 mc. The 3.5- and 7-mc. taps would be on  $L_2$ ;  $L_1$  and its tap would cover 14 and 28 mc.

Turns may be shorted by using copper clips of low resistance and large contact surface with the wiring or tubing composing the inductances. Special switches designed for the purpose also are available. In making a band-switching amplifier it is important that the switch leads be as short as possible and that the capacity to ground or the transmitter chassis be small.

Push-pull circuits may be switched by the method shown at Fig. 825-D, shorting outward from the center. The taps should be equidistant from the center-tap or ground point. Three bands can readily be covered by this method without appreciable loss of power at the highest frequency.

## Transmitter Troubles

● It is often the case that when the building of a transmitter is completed, at first trials its

behavior and power output are not what were expected or hoped. Erratic or unsatisfactory performance can be accounted for in many ways. One common fault is lack of sufficient grid excitation for the final stage, occasioned either through some circuit defect or because of "skippy" design. If the tube layout is not one that will give the requisite power gain at the desired frequency, no amount of fussing with the transmitter will cure it. Excitation can be quickly checked by measuring the grid current of the stage under consideration; if it is not at or near the value given in the tube tables, assuming that the plate and bias voltages are approximately as given, it is time to look for circuit defects, if the tube line-up is reasonable, or to alter the design in accordance with the principles outlined in the preceding section.

Occasionally a driver stage will give all the signs of operating efficiently and appear to be capable of delivering the required output, but the excitation is deficient. In such cases the trouble often can be traced to the interstage coupling circuit used. Some methods of coupling are preferable to others with certain types of tubes and at certain frequencies, as explained earlier in this chapter. Also, improper arrangement of return leads, particularly those acting as r.f. ground leads, often will cause a reduction in excitation. Loops in common ground connections or unduly long ground leads should be avoided. This point is considered further in Chapter Nine.

Improper adjustment is another cause of inefficiency. Particular attention should be

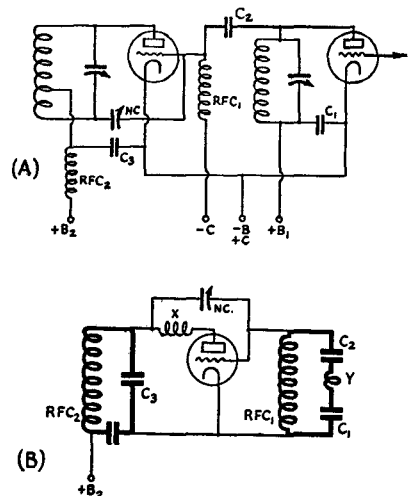

FIG. 826 — HOW LOW-FREQUENCY PARASITIC OSCILLATIONS CAN BE GENERATED

paid to link-coupled circuits, for instance, to make sure that maximum power is transferred. The number of turns in the link is likely to be rather critical, and time spent in making adjustments to the end of greater power transfer is well worth while. In capacity-coupled circuits, particularly those in which the coupling

generated is shown in Fig. 826. A driver and neutralized amplifier are indicated, but this type of oscillation can exist in any circuit having r.f. chokes in both the plate and grid circuits. There is always some capacity shunting the chokes; if the inductances of the chokes and the shunting capacities happen to be such that both chokes are tuned to approximately the same frequency, a tuned-grid tuned-plate type of oscillation may be set up. The normal tank circuits will have but little effect on the oscillation. If oscillations of this type occur they can be avoided, usually, by changing the size of the plate bypass condenser or by removing a choke in series-feed circuits. In general, it is better to omit r.f. chokes with series feed and depend upon the bypass condensers to keep the r.f. currents in the right path. If the bypass condensers are large enough the chokes will not be necessary.

A type of parasitic oscillation peculiar to the neutralized amplifier is indicated in Fig. 827. It results from the use of a tapped plate tank coil for neutralizing and a similar tap on the driver tank coil for control of excitation. The parasitic circuit, again a t.p.t.g. type of oscillation, is through the shaded parts of the tank coils. This is a particularly vicious type of parasite; it is a persistent oscillator and usually requires a change in the design of the transmitter for its cure. A neutralizing circuit using a split-stator condenser (Fig. 818-C) will cure it; so also will discarding the tap on the

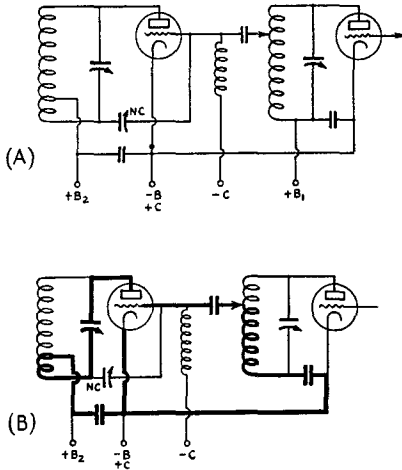

FIG. 827 — A HIGH-FREQUENCY PARASITIC CIRCUIT RESULTING FROM THE USE OF A TAPPED EXCITATION COIL

condenser is attached to the plate end of the driver tank, overloading because of the use of too-large coupling capacity should be avoided. When a stage is overloaded, its plate current will be higher than normal and the resonance dip will not be pronounced.

### Parasitic Oscillations

● If the circuit conditions in an oscillator or amplifier are such that oscillations at some frequency other than that desired can and do exist, such oscillations are appropriately termed "parasitic." The energy required to maintain a parasitic oscillation is wasted so far as useful output is concerned, hence an oscillator or amplifier afflicted with parasites will have low efficiency and frequently will operate erratically. In addition, parasitic oscillations in the self-controlled oscillator can ruin the frequency stability and spoil completely the character of the note.

Parasitic oscillations may be higher or lower in frequency than the nominal frequency of the oscillator or amplifier. Low-frequency parasites are relatively uncommon, but occasionally exist as the result of unfortunate choice of bypass condenser and r.f. choke values. One way in which such a parasitic oscillation can be

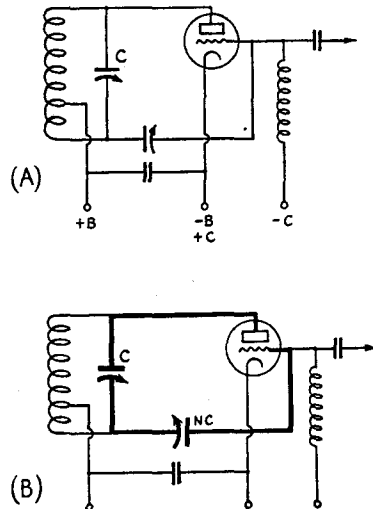

FIG. 828 — ULTRA-HIGH-FREQUENCY OSCILLATIONS CAN BE GENERATED IF THE LEADS FROM THE AMPLIFIER TUBE TO THE TANK CONDENSER ARE TOO LONG

# Principles of Transmitter Design and Operation

driver tank, feeding the amplifier grid through a smaller coupling condenser connected directly to the plate end of the driver tank coil. The latter scheme does not result in particularly efficient coupling between driver and amplifier, however. A change to inductive or transmission-line interstage coupling also will be beneficial.

Fig. 828 shows one way in which ultra-high frequency parasitic oscillations can be set up

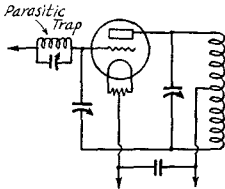

FIG. 829 — ULTRA-HIGH FREQUENCY TRAP TO ELIMINATE PARASITIC OSCILLATIONS

*The trap is quite effective when ultra-high frequency parasitic oscillations cannot be avoided by suitable circuit layout. Suggested values for the trap are a variable condenser of about 25  $\mu\text{fd}$ . maximum capacity and a coil having about three turns, two inches in diameter, with about a quarter inch between turns.*

in a neutralized amplifier: the same type of oscillation could exist in a Hartley oscillator with too-long leads. The leads to the tank circuit, if more than a few inches long, possess enough inductance to tune the shaded circuit in the three- to five-meter region; an ultraudion-type oscillation is set up. Changing the physical layout to shorten the leads should eliminate the parasitic.

A great many combinations of lead lengths can cause the generation of ultra-high frequency parasitic oscillations, particularly with tubes having large physical dimensions and large interelectrode capacities. When this trouble occurs, it is often possible to kill the parasite by inserting a wave trap, tuned to the ultra-high frequency region, in one of the leads. A representative example is given in Fig. 829. The trap condenser is adjusted to resonance at the parasitic frequency, causing the oscillation to stop. Such a trap will have negligible effect on the normal operation of the circuit.

## Neutralizing Difficulties

● Trouble is sometimes experienced in getting a triode amplifier completely neutralized. In cases of this kind the circuit should be checked over carefully to make sure that all connections are good and that there are no shorted turns in the inductances. Different sizes of neutralizing condensers may also be tried,

since circuit conditions vary considerably with different physical layouts. If a setting of the neutralizing condenser can be found which gives minimum r.f. in the plate tank circuit without completely eliminating it, the chances are that there is some magnetic or capacity coupling between the input and output circuits external to the tube itself. Short leads in neutralizing circuits are highly desirable, and the input and output inductances should be so placed with respect to each other that magnetic coupling is minimized. Usually this means that the axes of the coils should be at right angles to each other. In some cases it may be necessary to shield the input and output circuits from each other. Magnetic coupling can be checked for quite readily by disconnecting the tank from the remainder of the circuit and testing for r.f. in the plate tank circuit as the tank condenser is swung through resonance. The preceding stage must be running, of course.

Although the neutralizing circuit itself is a well-defined bridge and consequently should be capable of perfect balance, in practice there are many stray capacities left uncompensated for in the neutralizing process. The tube, for example, has capacity from grid to filament as well as from grid to plate; likewise there is unconsidered capacity between plate and filament. Similarly, capacities existing between parts of the socket enter into the picture with tubes having all three elements brought out to the same base. With large tubes, especially those having relatively high interelectrode capacities, these commonly neglected stray capacities can prevent perfect neutralization, or can operate in such a way that the amplifier will be neutralized with the plate tank set exactly at resonance but will go out of neutralization if the tuning is changed slightly. Symmetrical arrangement of a push-pull amplifier is about the only way to obtain a practically perfect balance throughout the amplifier.

## Coil Specification Charts

● As an aid to the constructor, charts showing the number of turns required in various commonly-used types of coils for different tuning capacities are given in Figs. 830, 831, and 832. Fig. 830 is for coils wound on receiving-type forms having a diameter of  $1\frac{1}{2}$  inches. Such coils would be suitable for oscillator and buffer stages where the power to be carried is not over 25 watts. In all cases the number of turns given must be wound to fit the length indicated; the turns should be spaced out evenly either by winding wire or string of suitable

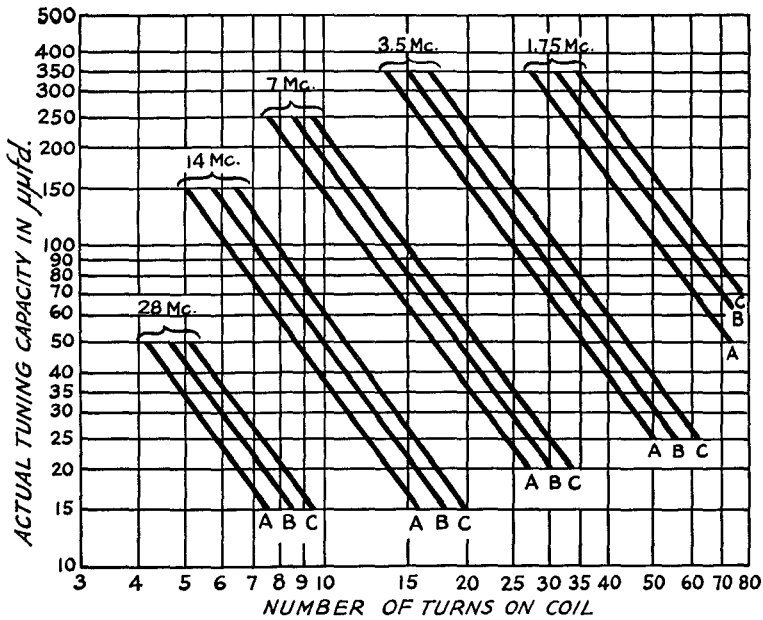

FIG. 830 — COIL-WINDING DATA FOR RECEIVING-TYPE FORMS, DIAMETER 1½ INCHES

Curve A — winding length, one inch; Curve B — winding length, 1½ inches; Curve C — winding length, 2 inches. After determining the number of turns for

the capacity and frequency band to be used, consult the wire table in the Appendix to find the wire size which will fit in the space available. No. 18 wire is about the largest size that need be used; larger sizes are difficult to handle on this type of form.

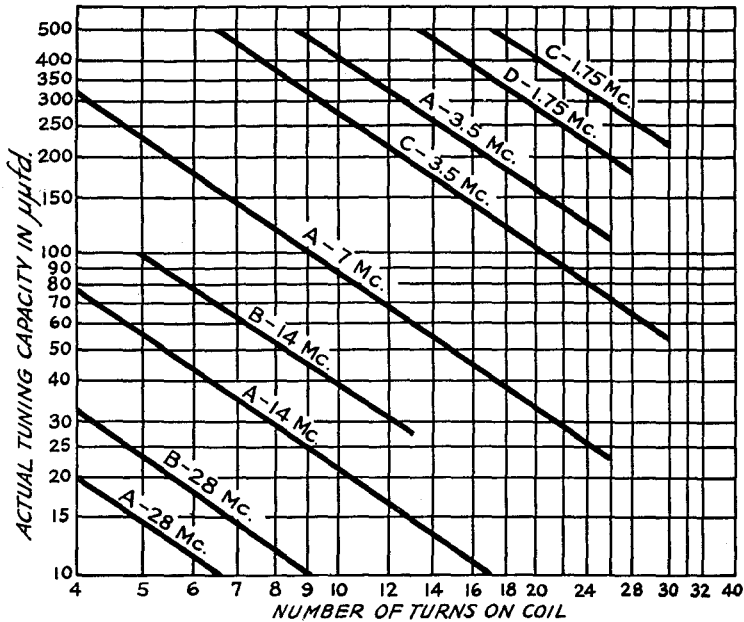

FIG. 831 — COIL-WINDING DATA FOR CERAMIC TRANSMITTING-TYPE FORMS

Curve A — ceramic form 2½-inch effective diameter, 26 grooves, 7 per inch; Curve B — same as A, but with turns wound in alternate grooves; Curve C — ceramic

form 2⅞-inch effective diameter, 32 grooves, 7.1 turns per inch, app.; Curve D — ceramic form 4-inch effective diameter, 28 grooves, 5.85 turns per inch, app. Coils may be wound with No. 12 or No. 14 wire.

# Principles of Transmitter Design and Operation

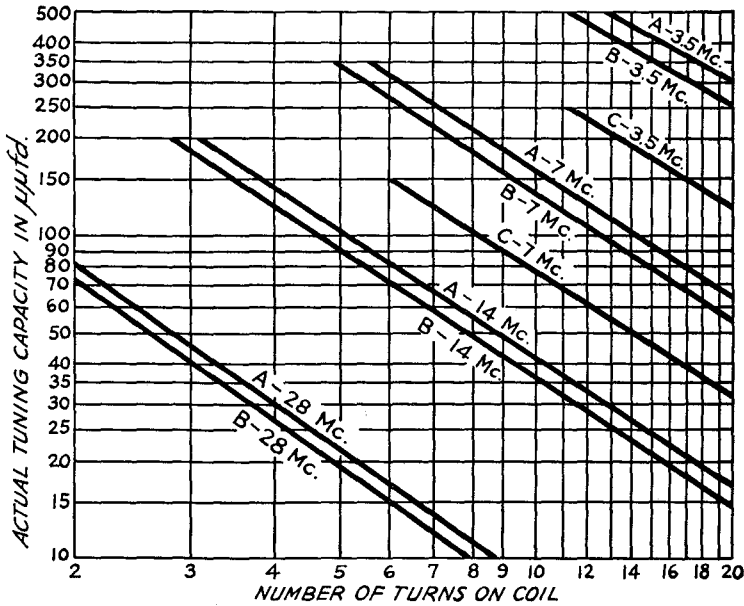

FIG. 832 — WINDING DATA FOR COPPER-TUBING COILS

Curve A —  $\frac{1}{4}$ -inch tubing, inside diameter of coil  $2\frac{1}{2}$  inches; Curve B —  $\frac{3}{16}$ -inch tubing, inside di-

ameter of coil  $2\frac{1}{2}$  inches; Curve C —  $\frac{1}{4}$ -inch tubing, inside diameter of coil 4 inches. In all cases the space between turns is  $\frac{1}{8}$  inch.

size between turns, or, in the case of those having few turns, by hand.

Fig. 831 gives data on coils wound on transmitting-type ceramic forms. Three popular types of forms are indicated. In the case of the smallest form, extra curves are given for double-spacing; that is, winding turns in alternate grooves. This is sometimes advisable in the case of 14- and 28-mc. coils when only a few turns are required. In all other cases it is assumed that the specified number of turns

is wound in the grooves without any additional spacing.

Data on copper tubing coils is given in Fig. 832. One-eighth inch is allowed between turns to permit inserting clips for connections.

In all three charts the capacity indicated is the *actual* capacity shunting the coil. This includes tube and stray circuit capacity; an allowance of at least  $10 \mu\mu\text{fd.}$ , and usually 15 or  $20 \mu\mu\text{fd.}$ , must be made for this stray capacity.

# 9

## ***Building Transmitters***

### **TYPES OF CONSTRUCTION — WIRING POINTERS — OSCILLATORS — EXCITER UNITS — AMPLIFIERS — COMPLETE TRANSMITTERS**

**T**HE construction of a transmitter, whether small or large, offers an excellent opportunity for the exercise of ingenuity along both mechanical and electrical lines. Mechanically, the design of a transmitter is not so restricted as that of a receiver, which is customarily constructed so that its controls are continually within reach on the operating table. The transmitter, however, can be built for table or floor mounting, for direct or remote control; it may be run horizontally or vertically, in one piece or unit style.

Transmitter construction usually follows one of several general types. For experimental work the "breadboard" type of construction, in which the apparatus is mounted on a flat wooden board and arranged for best performance, has long been popular. In recent years metal chassis have been made available to set constructors, and these have been adapted to use with transmitters. Again, many amateurs like to mount their apparatus on shelves which are stacked one above the other in a wooden or metal frame, usually with controls brought out to a panel covering the front. The vertical type of construction reaches its highest development in the relay rack, a unit-type rack-and-panel method of building in which separate units are self-contained and completely interchangeable, since relay-rack dimensions are standardized.

#### **Breadboard and Metal Chassis**

● The breadboard type of construction offers many advantages. It is inexpensive; circuit components can be arranged for electrical efficiency rather than for ease of control, since there is no panel to which all controls must be brought; and all parts are readily accessible for adjustment or replacement. Insulation presents no great difficulties, since the baseboard itself is a good insulator, for supply voltages at least. On the other hand, the breadboard transmitter collects dust very readily and

hence must be frequently cleaned. It does not have the finished appearance of the more advanced types of construction, although careful layout and workmanlike wiring undoubtedly can be combined to make an attractive job.

The metal chassis is closely related to the breadboard, at least when used for open construction without a panel. Unlike the breadboard, however, the metal chassis offers a means for making grounds and serves as a basis for shielding. Then too, most of the wiring and small parts are conveniently mounted underneath the chassis so that the appearance of the set is improved. Present day components, such as tube sockets, bypass condensers, resistors, etc., utilized in low-power transmitters are more suitable for mounting on metal than wood. A metal chassis unit of the proper size and provided with a panel can very easily be adapted to relay-rack style of construction.

Metal chassis pans are available in many sizes, from two inches deep and about seven by seven inches square up to three inches deep and 23 by 10 inches.

#### **The Vertical Frame**

● Eventually most amateurs come to the vertical frame or rack type of construction, in which all parts of the transmitter are grouped together in one unit. This type is preferable for a permanent outfit, but usually is not so readily accessible for experimenting and trying out different tubes and circuits as the breadboard type. Since most of the apparatus is concealed by the panel, good external appearance can be attained even though the constructor does not have the knack of making layout and wiring in commercial style.

Frames usually are four-posted affairs made from 1 by 2, 2 by 2 or even larger wood, depending upon the weight to be carried. The shelves holding the apparatus may be breadboards or similar flat boards; they can be



fastened to the corners of the frame by small metal angles or mounted on cross-strips screwed to the posts. Provision should be made for removing the shelves for alterations or replacements without too greatly disturbing the remainder of the transmitter. The panel, usually in one piece, can be made from plywood or from one of the wood-pulp products such as Presdwood.

In mounting apparatus in the frame the power supply equipment, being heaviest, usually occupies the bottom section, with the r.f. equipment above. The antenna-tuning apparatus usually is at the top.

### The Relay Rack

● The relay rack type of construction offers many advantages not to be found in the other styles. Its appearance is good, parts are quite accessible, and alterations which change the physical size of one section of the transmitter can be made without requiring corresponding alterations in other sections, as would be the case with a frame-mounted transmitter. The reason for this is that each section of the transmitter — such as a power supply unit, exciter, amplifier, and so on — is provided with its own mounting shelf and panel and thus is in itself a complete unit, quickly removable after disconnecting supply wires. All the apparatus of the unit is supported by the panel.

The true relay rack has two uprights made of channel iron, mounted on an iron base. Panels are also of metal, usually steel or aluminum, and generally are  $\frac{3}{16}$  or  $\frac{1}{4}$  inch thick. The universality of the relay rack is attained because dimensions have been completely standardized. Panels are 19 inches wide, and of varying heights measured in "rack units," a rack unit being  $1\frac{3}{4}$  inches. To allow for stacking and slight inaccuracies in cutting, a relay-rack panel is always made to be a certain number of rack units high less  $\frac{1}{32}$  inch for clearance. Thus a panel four rack units high will measure 7 inches less a  $\frac{32}$ nd. The channel uprights of the rack are drilled to take 10-32 mounting screws at standardized intervals as shown in Fig. 901. The edge of a panel always comes midway between two holes spaced one-half inch apart.

Although the apparatus usually is mounted on a shelf suspended from the rack panel, an alternative type of construction, using a vertical sub-base, also may be used. This type of construction, known as "dish" mounting, has several advantages. Parts and tubes are more readily accessible than on a shelf; also, the apparatus usually will take up less room.

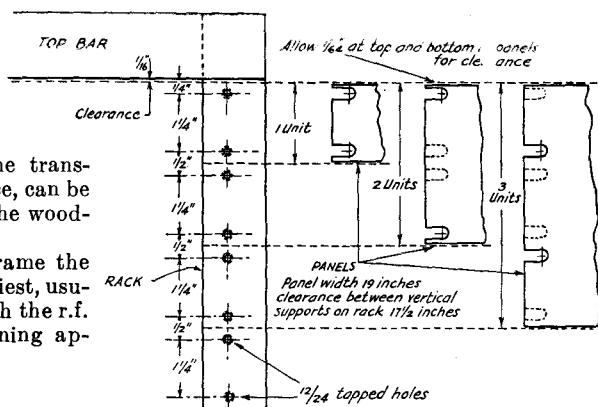
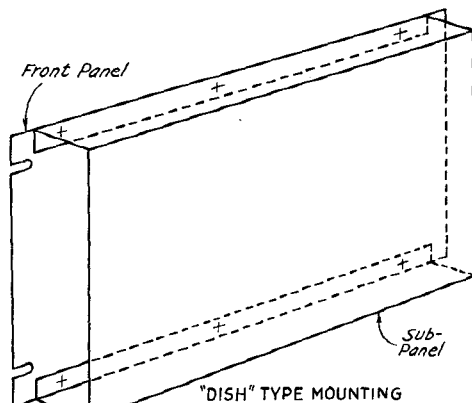

**FIG. 901 — DRILLING AND PANEL DIMENSIONS OF THE STANDARD RELAY RACK**

*The mounting holes should be drilled  $\frac{3}{8}$  inch from the inner edge of the upright. The lateral distance between hole centers is  $18\frac{1}{4}$  inches. Homemade panels may be slotted, as shown, or may have round holes drilled at the proper intervals and with the lateral spacing given.*

### Home-Made Relay Racks

● Commercial relay racks may be obtained for either floor or table mounting. The floor type with standard drilling is quite expensive, while the table size usually is large enough only for low-power transmitters. Floor racks with so-called "amateur standard" drilling can be obtained at less cost than the standard relay rack; the difference is that the mounting holes in the rack are spaced at regular intervals of  $1\frac{3}{4}$  inches instead of alternately  $1\frac{1}{4}$  and  $\frac{1}{2}$  inches as shown in Fig. 901. Because there are only half as many holes, this type of rack will not mount properly all panels drilled to the standard dimensions. It is thus less flexible,



**FIG. 902 — THE "DISH" TYPE OF SUB-PANEL MOUNTING FOR THE RELAY RACK**

# The Radio Amateur's Handbook . . . . .

although perfectly satisfactory with suitably-drilled panels.

The cost of a fabricated relay rack need not deter the builder from obtaining the advantages of relay-rack construction, particularly the standardization of sizes and the inter-

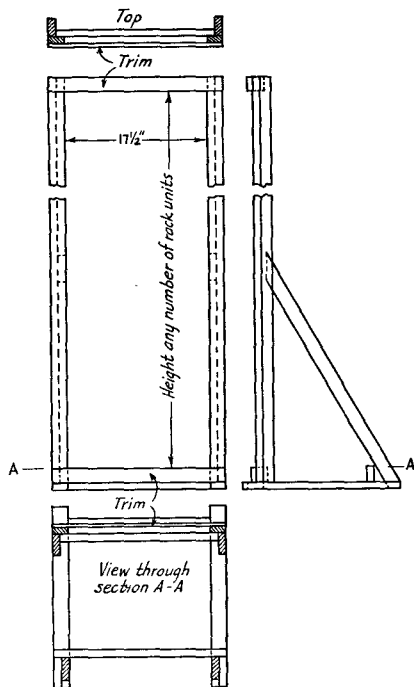

FIG. 903 — SUGGESTED CONSTRUCTION OF AN INEXPENSIVE WOODEN RELAY RACK

The height of the uprights will depend upon the number of panels to be used. The space available for panels should be some multiple of a rack unit (13 1/4 inches). See Fig. 901 for standard dimensions.

changeability of units. No amateur transmitter is a really permanent affair; always there are improvements to be made, new circuits to be tried, new gadgets and units to be added. Utilization of standard dimensions in the construction of transmitter sections is an invaluable convenience when the time comes for such changes to be made. Perfectly satisfactory racks can be built at home at a cost of only a dollar or two, while the panels can be made of plywood or one of the several crackle-finished wood-pulp panel materials now available at reasonable prices. The excess cost over bread-board construction is therefore negligible; the good appearance, flexibility and small floor space required fully justify the slight extra trouble of constructing the rack and fitting out

the various units with panels of the correct dimensions.

A successful design for a light home-built wooden rack is shown in Fig. 903. It is made entirely of dressed 1 by 2 white pine or cypress, with the exception of the trimming pieces across the top and bottom, which may be of 1/4-inch stock. Each upright is made of two pieces of 1 by 2 butted together as shown; this method prevents warping and gives the strength of an "L" girder, while providing a channel for running concealed wiring between units. The top and bottom may be finished off as indicated or in some other suitable manner; the exact method is not important so long as the rack sits firmly on the floor. The diagonal braces, which should meet the uprights about three feet from the bottom, will prevent the rack from weaving.

The inner edges of the uprights should be spaced exactly 17 1/2 inches apart. The space for panels may be any desired number of rack units. It is a good plan to mark off the mounting hole centers along the uprights and then drill a small hole about a half inch deep at each point as a guide to the wood screws which hold the panels in place. This will ensure mounting the panels properly and will prevent splitting the uprights. One-inch No. 8 wood screws are large enough, as panel-mounting screws, to hold any reasonable weight, assuming 1/4-inch panels.

The heavy power-supply apparatus may be mounted on a shelf which rests directly on the bottom of the rack. Small power supplies can be wholly supported from the panel and rack. The rack may be made deep enough at the bottom to support the large power supply.

With the panels in place, a rack of this type is surprisingly rigid despite its lightness, and is

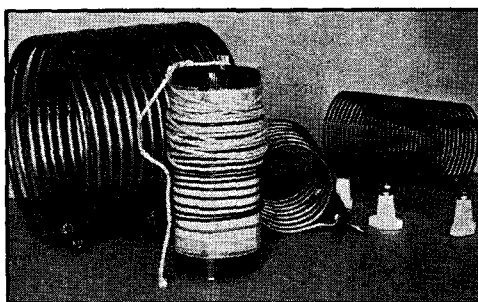

FIG. 904 — COILS WOUND ON CELLULOID STRIPS, SHOWING THE WORKING MATERIALS NEEDED FOR CONSTRUCTION

The coil on the bakelite form is in the middle of the winding process, about to be spaced with the heavy string before tightening and cementing.

strong enough to handle almost any amateur equipment.

#### Materials for Construction

● Besides the metal chassis pans already mentioned, many other useful "gadgets" and materials are available to the constructor. Metal frames suitable for holding transmitters of moderate size are marketed by a number of manufacturers. Some types come complete as one unit, with a single panel, while others have separate panels. One manufacturer furnishes panels suitably drilled to take a considerable number of circuit arrangements, thus saving the builder the labor and necessity for acquiring tools and equipment for cutting holes in metal.

Relay rack panels of various sizes, made of aluminum or steel finished in crackle, also can be obtained from amateur suppliers. Wood-fibre panels, likewise finished in the popular black crackle, also are available. These are easily worked, besides being relatively inexpensive. A material of this type known as "Lamtex" is used in several of the units to be described later in this chapter.

#### Winding Transmitting Inductances

● Although most circuit components can be purchased at quite reasonable prices, many amateurs wind their own transmitting inductances. This is partly because the inductance of the coil must be adjusted to fit the particular condenser used, and partly because of mechanical considerations.

Coils for low-power stages, handling twenty-five watts or less, can be wound on ordinary receiving coil forms, using relatively small wire. However, when the power to be handled is fairly large, heavier conductors must be used to avoid heating. Number 14 or 12 wire, properly spaced, will carry the output of most medium-power amplifiers without undue heating, especially when the optimum or higher *L-C* ratio is used. In high-*C* circuits or in high-power tank circuits copper tubing is generally used; sizes of tubing range from  $\frac{1}{8}$  to  $\frac{1}{4}$  inch.

The chief requirements for a good transmitting coil are that its resistance be low (large conductor and proper proportioning of dimensions) and that it be mechanically rigid. The turns should not be "floppy" because if vibration occurs the inductance will change at the same rate, modulating the output of the transmitter. If the coils are plug-in, it should also be possible to handle them a great deal without getting turns out of place or breaking off terminals. Plug-in coils larger than those wound on receiving coil forms usually are pro-

vided with G.R.-type plugs fitting into jacks mounted in a strip of bakelite or in special stand-off insulators.

Coils for transmitters of a few hundred watts often are wound on grooved ceramic forms available from several manufacturers. Such inductances are easy to make, and if wound with bare wire can readily be tapped at any point.

Copper tubing may be wound by first clamping one end of a piece of the requisite length in a vise, next fastening the other end to a piece of iron pipe approximately the desired diameter of the finished coil, and then winding by turning the pipe in the hands while pulling hard on the tubing to keep it straight. The turns should be wound tightly together, spacing being adjusted after the coil is finished by spreading the turns with the shaft of a screw-driver.

Another type of coil construction utilizes thin bakelite strips, drilled at proper intervals to give the desired turn spacing, to support the turns. Three or four such strips will be sufficient. Coils of this type are illustrated later in the chapter. To make them, the strips should be drilled, one strip having one extra hole to take care of the end of the winding, the others having the same number of holes as the number of turns on the coil. The coil itself is wound separately on a form of the proper diameter. The loose coil is then removed and the wire fed through the strips a turn at a time, starting with the strip with the extra hole. It is not difficult to do, although taking a little time. The holes in the strips should be large enough to pass the wire or tubing without binding. After threading through the strips the turns may be fastened firmly in place with Duco cement.

A third type of coil is shown in Fig. 904. In this case the supporting strips are celluloid, cemented to the coil turns. A winding form such as a bakelite tube of proper diameter should be covered with several layers of paper; the wire is fastened at one end with a machine screw and nut through the form and wound on to the desired number of turns, after which three or four celluloid strips are slid under the wire at proper intervals around the form. The turns are then spaced by winding string or wire of the proper diameter between them. After spacing, the turns should be tightened up and the other end of the winding fastened to the form. Duco cement is run in between the turns along the celluloid strips and allowed to dry for an hour or two, when another application of cement is made. The second coat should be allowed to dry overnight, after

which the turns will be firmly cemented to the celluloid strips. The paper may then be pulled or cut out and the finished coil slid off the form. The coils are quite strong and rigid. Even large-size copper-tubing coils can be made by this method, although it is generally used with

metallic object is introduced into the field of a coil, currents are induced in the object which cause heating and resultant power loss. Fig. 906 shows the right and wrong way to mount inductance coils in relation to other circuit components. The field of the coil is strongest at the ends and weakest at right angles to the axis, hence the ends of the coil should be isolated from other parts of the circuit whenever possible. To confine the field of the coil to a small space, its length should be two or three times its diameter.

ends and weakest at right angles to the axis, hence the ends of the coil should be isolated from other parts of the circuit whenever possible. To confine the field of the coil to a small space, its length should be two or three times its diameter.

Coils for r.f. circuits, particularly at the higher frequencies, should be space wound. The distributed capacity of the coil is reduced by spacing the turns. Since at high frequencies an appreciable current can flow between turns because of distributed capacity, the current and hence the losses can be reduced by spacing. Space-

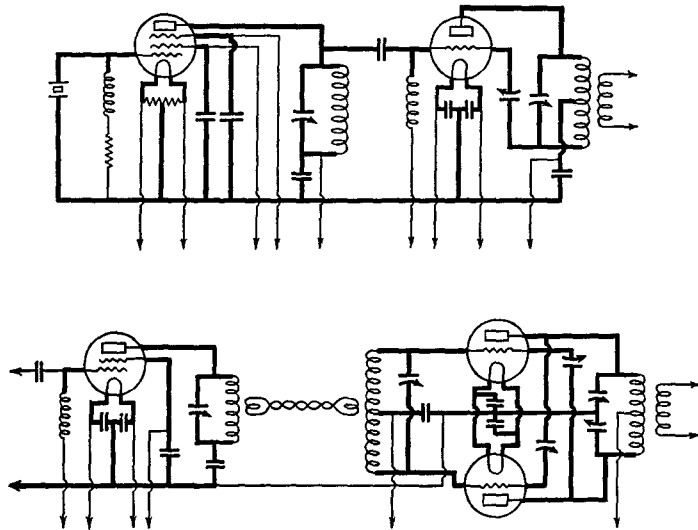

FIG. 905—LEADS CARRYING RADIO-FREQUENCY CURRENT, INDICATED BY THE HEAVY LINES, SHOULD BE AS SHORT AS CIRCUMSTANCES WILL PERMIT

ing equal to the diameter of the conductor used is sufficient.

wire coils. Complete coils of this type are available from several manufacturers.

### Arrangement of Circuit Components

● In fixing upon a layout for the parts of the circuit, care should be taken to make those leads carrying r.f. as short as possible. The leads carrying supply voltages need not be so short, although they should be kept well removed from r.f. parts of the circuit.

Fig. 905 indicates the leads which should be short in two typical diagrams. It is not enough to have short leads in the tank circuits; bypasses should be made as directly as possible to the ground point. Neither should "hot" r.f. leads be close together; this introduces stray capacity coupling and may cause feedback or prevent neutralization of an amplifier. Considerable thought should be given to the arrangement of apparatus to obtain short r.f. leads and yet keep each component isolated as much as possible. The time thus spent will be well repaid in improved performance.

Unnecessary losses can be caused by improper placement of inductances. Whenever a

### Grounds

● The way in which "ground" or return connections are made may have a considerable effect on the operation of the circuit. Ideally, all ground connections in the transmitter should have the same r.f. potential. Unfortunately, however, all leads, no matter how short, possess some inductance and resistance, and it often happens that two points theoretically grounded may show a difference in potential in practice. The nearest approach to the ideal ground would be a large metal sheet of high conductivity on which all apparatus is mounted, the grounds to the metal sheet being made in all cases with leads of negligible length. In practical construction, a metal chassis makes a satisfactory ground; the large surface reduces both inductance and resistance to very low values in most cases. When such a chassis is used, ground returns should be made directly to the chassis with short, direct connections; avoid, if possible, grounding any two circuit elements to the same point on the chassis, and never use a single ground wire for two or more bypass condensers, even though the common ground wire be quite short. With two condensers grounded through the same

# Building Transmitters

wire, the wire provides a coupling between the two circuits which the grounding is supposed to avoid.

This principle is illustrated in Fig. 907, adapted for construction on insulating material such as a breadboard. In this case, since no metal ground of large surface is available, it is best to bring all ground connections for each stage to a single point, connections between stages being made also by a single wire between the common ground points. In wooden frames or racks, where several stages may be mounted one above the other, loops and circuitous returns up and down the opposite sides of the frame should be avoided. In such cases, it is advantageous if a coupling system which does not require the ground connections to carry r.f. current is used; for example, link-coupling between stages on different shelves will avoid grounding troubles.

If the transmitter units are mounted on a bakelite, pressed wood or plywood base, a satisfactory ground can be made by covering the bottom of the base with a thin sheet of aluminum or copper and making grounds to this sheet just as though it were a metal chassis. This type of construction is used in some of the transmitter units illustrated in this chapter.

Poor grounding can account for many transmitter eccentricities, including inadequate excitation in a transmitter layout which on paper has ample driving power, and inability to neutral-

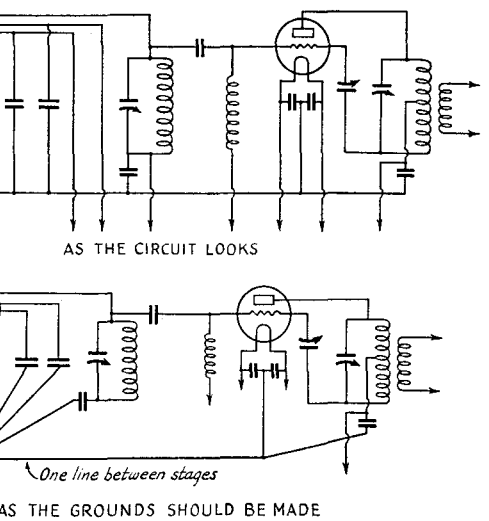

**FIG. 907 — WHEN THE TRANSMITTER IS BUILT ON INSULATING MATERIAL, GROUND LEADS FOR EACH STAGE SHOULD BE BROUGHT TO ONE POINT, WITH GROUND CONNECTIONS BETWEEN STAGES MADE AS SHOWN**

ize a triode amplifier. It is often also responsible for oscillation in screen-grid amplifiers.

### Practical Examples of Transmitter Design

● The following examples of oscillator, amplifier and complete transmitter construction have been selected to illustrate different types of mechanical arrangement and representative methods of circuit design. The amateur who does not wish to duplicate a particular transmitter or unit undoubtedly will find many ideas which will be of value to him in planning a layout to fit his individual needs.

Many of the units, particularly those designed for relay-rack mounting, will be found to match well so that two or more can be assembled into a complete transmitter. When single amplifier units are described, the excitation power requirements are given, so that it is a simple matter to select a lower-power unit capable of delivering the required output to use for driving purposes.

In examining the apparatus described in this chapter, the reader should keep in mind the fact that the brand name and type numbers of the parts

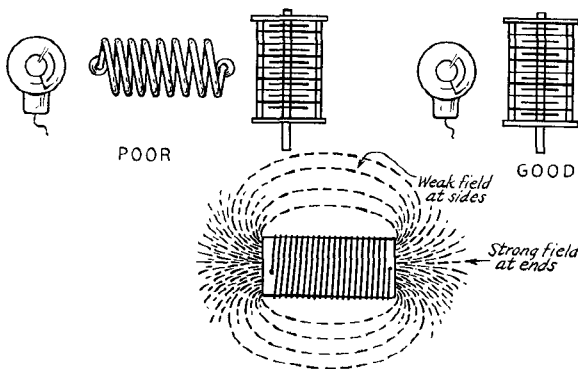

**FIG. 906 — THE RIGHT AND WRONG WAY TO MOUNT COILS IN THE SET**

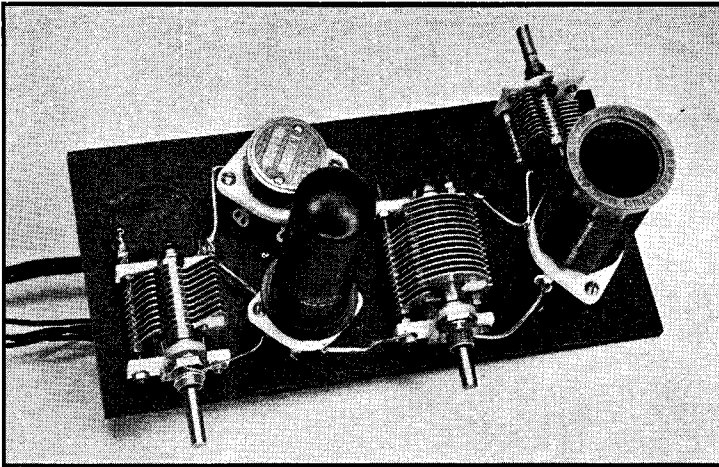

FIG. 908 — A SIMPLE TWO-BAND TRANSMITTER USING A 6L6

This outfit is built for either use at the home station or as a portable. With a 3.5-mc. crystal having a frequency between 3500 and 3650 kc., it can be used for both 3.5 and 7-mc. work.

The cathode tuning condenser,  $C_1$  (Fig. 909), is at the left on the front edge; the condenser at the right is  $C_2$ , the plate tuning condenser. The cathode coil is cemented flat on the base just behind  $C_1$ .

actually used in the equipment pictured are given in almost all cases simply as a convenience to those who may wish to duplicate some particular transmitter or unit. Apparatus of any reliable make may be substituted for that specified, of course, except possibly in a few instances where the mechanical layout is based on a particular piece of apparatus. In making such substitutions, however, it is highly important that the specified electrical values be duplicated exactly; the important things in the circuit are the inductance, capacity and resistance, with their voltage, current and power ratings. In some cases, minor layout changes may be necessitated by the substitution of a different part; should such a change be necessary, the constructor should be guided by the principles already discussed in this chapter.

Because space is necessarily limited, the descriptions to follow do not include information on routine tuning and other adjustments such as neutralizing; the reader is referred to Chapter Eight for this information. However, all essential constructional and special operating information is given, although concisely. For the convenience of those who want more detailed descriptions, reference is made to the *QST* issue in which the apparatus was originally described, in cases where such descriptions have already been published. A number of units, however, appear for the first time in this *Handbook*.

## A Simple Low-Power Transmitter for Station or Portable Use

● For the first transmitter, many amateurs use a simple crystal rig in either the regular pentode or Tri-tet oscillator circuit. The latter has the advantage of giving output on two bands with a single crystal. Such an outfit is inexpensive, is easy to build and adjust, and with suitable tube and power supply is capable of enough power output for quite satisfactory work. Should more power be desired later, the same oscillator can be used to excite an amplifier or series of them — or at

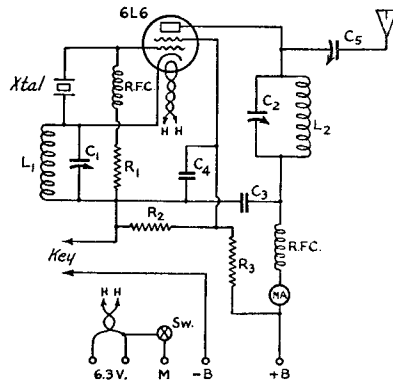

FIG. 909 — CIRCUIT DIAGRAM OF THE 6L6 CRYSTAL OSCILLATOR TRANSMITTER

$L_1$  — 11 turns of No. 30 d.c.c. wire, scramble-wound and cemented with Duco Cement; diameter  $1\frac{1}{2}$  inches.

$L_2$  — 24 turns of No. 18 enamelled wire, wound on  $1\frac{1}{2}$ -inch bakelite form. Turns spaced to occupy a winding length of  $1\frac{1}{2}$  inches.

$C_1$  — 100- $\mu$ fd. midget condenser (National ST-100).

$C_2$  — 140- $\mu$ fd. midget condenser (National ST-140).

$C_3$  — .002- $\mu$ fd. mica condenser (Sangamo).

$C_4$  — .005- $\mu$ fd. mica condenser (Sangamo).

$R_1$  — 250,000 ohms,  $\frac{1}{2}$  watt (IRC).

$R_2$  — 50,000 ohms, 2 watt (IRC).

$R_3$  — 3000 ohms, 10 watt wire-wound (IRC).

RFC — High-frequency r.f. choke (National 100).

With plate voltages of 250 or less,  $R_2$  and  $R_3$  are not needed, the screen voltage return being connected directly to the positive terminal of the plate supply.

## Building Transmitters

least the same components are available for building into a more elaborate transmitter.

Figs. 908 and 910 show a transmitter of this sort, constructed so that it can be used either in the regular station or carried along on trips for portable work. Although it is quite compact, power outputs of about 15 watts on 3.5 mc. and 10 watts on 7 mc. can be obtained without difficulty, with a power supply giving 350 volts at about 100 milliamperes. The circuit, shown in Fig. 909, is arranged so that the 6L6 oscillator tube works as a Tri-tet for 7-mc. output, and as a straight pentode oscillator for 3.5 mc. output. The shift in connections is accomplished by bending the tip of one rotor plate of the cathode condenser,  $C_1$ , so that it shorts to the stator when set at maximum capacity, thus converting the circuit to the pentode arrangement.

The oscillator is built on a Presdwood base measuring  $9\frac{1}{2}$  by  $4\frac{1}{2}$  inches. The base slides into the plywood container on strips of wood fastened to the sides. The cathode tuning condenser is at the left; that for the plate circuit at the right. The antenna coupling condenser,  $C_5$ , is mounted so that its shaft projects through a hole in the rear of the cabinet. The layout is quite simple, and there should be no difficulty in following it. The plate tank circuit is proportioned so that the 3.5-mc. band is reached with  $C_2$  set near maximum capacity and the 7-mc. band with  $C_2$  near minimum capacity, so that it is not necessary to change the plate coil when going from one band to the other.

The switch,  $Sw$ , shown in the circuit diagram is needed only when the transmitter is to be used as a portable. Its purpose is to control the battery circuit to a Genemotor or vibrator-type power supply so that current can be conserved by switching off during listening periods.

The antenna coupling is arranged for a simple end-fed antenna without feeders. The antenna should be cut to the proper length for the crystal used; Chapter Sixteen gives the formula. Coupling is adjusted by varying the capacity of  $C_5$ , with simultaneous adjustment of  $C_2$  to resonance each time  $C_5$  is changed, to bring the minimum plate current to 75 milliamperes, approximately. The tuning and adjustment procedure for both pentode and Tri-tet oscillators is given in Chapter Eight. Particular attention should be paid to the setting of the cathode condenser,  $C_1$ , to obtain maximum output on the harmonic without

crystal heating, especially when 350 volts is used on the oscillator.

A suitable power supply may be made from receiver-type parts, using one of the circuits given in Chapter Fifteen.

The 6L6 transmitter was described in November, 1936, *QST*.

### A 47-46-10 Transmitter for Four Bands

● One of the most popular tube combinations for the low-power transmitter is that incorporating a 47 crystal oscillator, 46 doubler, and 10 final amplifier. Such a rig is simple to build and adjust, and with suitable crystals can be operated in any of the four bands from 1.75 to 14 mc. The accompanying photographs show an effective layout for this type of transmitter, suitable for either table or rack mounting. An antenna tuning unit for operation with an end-fed 3.5-mc. antenna on all bands also is shown.

The arrangement of tubes and parts, shown in the top view, follows the circuit diagram, Fig. 913, from left to right. Power supply leads are brought out to terminal strips at the rear of the baseboard. The 47 is used as a straight crystal oscillator, the 46, with Nos. 1 and 2

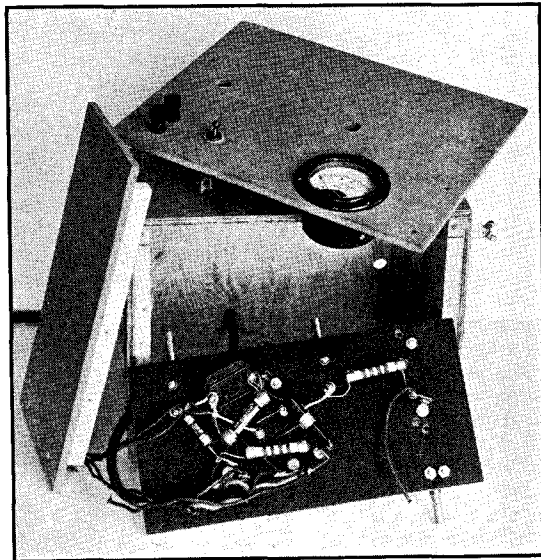

FIG. 910 — A BOTTOM VIEW OF THE 6L6 OSCILLATOR, SHOWING THE PLYWOOD CABINET AND FRONT PANEL

The wires to the plate milliammeter, on-off switch for the plate supply, and key terminals have been disconnected to show the construction. Bypass condensers and resistors are placed in convenient locations; no layout precautions are necessary aside from getting short bypass connections. Outside dimensions of the cabinet are: width, 10 inches, height, 8 inches, depth,  $4\frac{3}{4}$  inches.

# The Radio Amateur's Handbook . . . . .

grids connected together, as a high- $\mu$  triode doubler, and the 10 as a neutralized amplifier. Output from the oscillator may be fed to either the 46 or 10 grid by means of flexible cord with a 'phone tip which plugs into a tip-jack strip of the type used for speaker con-

nections. A similar arrangement is used to connect the 10 grid to either the 47 or 46 output. When the transmitter is to give power output on the same frequency as the oscillator, the 46 is cut out of the circuit by plugging the 'phone tips into the upper jacks in the diagram. For operation at twice the crystal frequency, the tips go to the lower jacks, putting the 46 doubler in circuit. The amplifier is biased partly by the grid leak,  $R_3$ , and partly by a 45-volt battery, the latter being provided for protection of the amplifier tube in case excitation should fail. The battery may be omitted without perceptible difference in the operation of the amplifier; in such case the negative "C" terminal in Fig. 913 is simply connected to the left-hand key terminal.

antenna tuner, consisting of a coil and condenser, is mounted on a 6 by 7 inch baseboard with an 8 by 6 inch panel. To permit putting wiring, bypass condensers, resistors and chokes below the baseboards, the latter are mounted on  $\frac{3}{4}$ -inch high wooden strips. The underneath view of the transmitter shows the general arrangement of parts.

As shown in the top view, the neutralizing condenser,  $C_4$ , is mounted on one side of the final tank condenser,  $C_3$ . The other parts can be readily recognized.

With this set it is possible to work on four bands with two crystals, one on 1.75 mc. and one on 7 mc., provided their second harmonics fall within the next higher frequency band. Crystals for the 3.5-mc. band may be used as well, however. The following table indicates the coils to use for various crystal and output frequencies:

Crystal Frequency	Output Frequency	Osc. Coil $L_1$	Doubler Coil $L_2$	Amp. Coil $L_3$
1.75 mc.	1.75 mc.	1.75 mc.	Cut Out	1.75 mc.
1.75 mc.	3.5 mc.	1.75 mc.	3.5 mc.	3.5 mc.
3.5 mc.	3.5 mc.	3.5 mc.	Cut Out	3.5 mc.
3.5 mc.	7 mc.	3.5 mc.	7 mc.	7 mc.
7 mc.	7 mc.	7 mc.	Cut Out	7 mc.
7 mc.	14 mc.	7 mc.	14 mc.	14 mc.

FIG. 911 — PANEL VIEW OF THE 47-46-10 TRANSMITTER WITH ITS ANTENNA-TUNING UNIT

Four closed-circuit jacks are indicated on the diagram for measuring plate currents of all three tubes and grid current to the final amplifier. A 0-100 scale milliammeter will have ample range for this purpose. With the jack connections made as shown, the "plus" side of the meter should be connected to the plug sleeve and the "minus" side to the tip.

The transmitter is built on a 7 by 15 inch baseboard and has an 8 by 16 panel to hold the tuning condensers, meter and jacks. The

Tuning and neutralizing adjustments are as described in Chapter Eight. Under load the oscillator tube should draw about 35 milliamperes and the buffer about 50 ma. These currents will vary somewhat with the frequency, being lowest at the lower frequencies. The antenna coupling to the amplifier should be adjusted to make the 10 draw approximately 60 milliamperes when  $C_3$  is tuned to

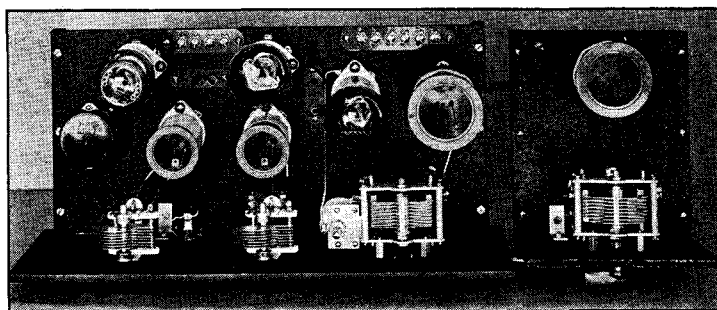

FIG. 912 — A TOP VIEW OF THE 47-46-10 TRANSMITTER

Oscillator at left, doubler in center, amplifier at right. The crystal plugs into the socket at the extreme left of the baseboard. Note the tip-jack strips, one to the rear of the oscillator coil and the other to the left of the amplifier tube socket, for cutting the doubler in and out of the circuit.



resonance. The amplifier grid current should be between 5 and 10 milliamperes with the tube loaded. The power output should be 20 to 25 watts under the current and voltage conditions specified. Greatest output will be secured on 1.75 and 3.5 mc., since the efficiency is lower on 7 and 14 mc.

The antenna tuning unit is intended for operation with a 132-foot single-wire antenna, the end of which is brought into the operating room. For 1.75 mc., the appropriate coil is connected as shown at B in Fig. 915, in series with the condenser. The antenna is worked as a grounded or Marconi antenna on this band. The ground lead should be short. On the other

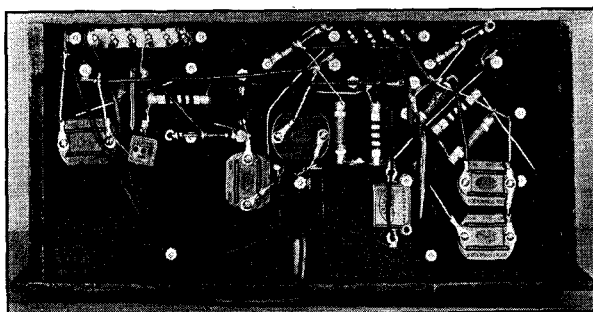

FIG. 914 — MISCELLANEOUS PARTS AND WIRING ARE MOUNTED BENEATH THE BASEBOARD  
A bottom view of the 47-46-10 transmitter.

three bands, the coil and condenser are in parallel, as shown at A, Fig. 915. Coupling between the plate tank and antenna circuits is made through a link line with a turn or two around the center of  $L_3$  and the same at the antenna coil. Some adjustment of the number of link turns may be necessary to transfer power most effectively. The general method of tuning this type of system is given in Chapter Sixteen in the section on end-fed antennas.

Suitable power supplies for the transmitter are described in Chapter Fifteen. The supply for oscillator and doubler should deliver 400 volts at 85 ma., approximately, and that for the 10 amplifier 500 to 600 volts at 60-70 milliamperes.

This transmitter was originally described in August, 1936, *QST*.

### A Two-Tube Five-Band Exciter or Low-Power Transmitter

● A relay-rack type exciter or low-power transmitter unit, using two pentode-type tubes, is shown in Figs. 916 and 918. Plug-in

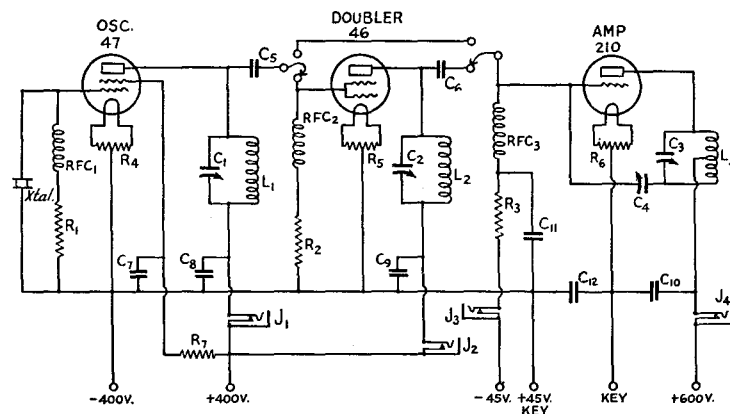

FIG. 913 — THE 47-46-10 TRANSMITTER CIRCUIT

$C_1, C_2$  — 100- $\mu$ fd. midget variable oscillator and doubler tank condensers (Hammarlund MC-100-M).

$C_3$  — 150- $\mu$ fd. variable amplifier tank condenser (Cardwell MR-150-BS).

$C_4$  — Neutralizing condenser (Cardwell ZT-30-AS).

$C_5, C_6$  — 0.0001  $\mu$ d. fixed mica coupling condensers, transmitting type.

$C_7, C_8, C_9, C_{10}, C_{11}$  — 0.002 fixed mica bypass condensers.

$R_1$  — 7500-ohm 2-watt resistor.

$R_2$  — 20,000-ohm 2-watt resistor.

$R_3$  — 15,000-ohm 10-watt resistor.

$R_4, R_5$  — 20-ohm center-tapped, wire wound.

$R_6$  — 60-ohm center-tapped, wire wound.

$R_7$  — 50,000-ohm 2-watt.

RFC1, RFC2, RFC3 — National Type 100 r.f. chokes.

$L_1$  — 1.75 mc.: 51 turns No. 22 d.c.c. wire, close wound.

3.5 mc.: 21 " " " " " "

7 mc.: 12 " " " " " "

$L_2$  — 3.5 mc.: 21 " " " " " double spaced.

7 mc.: 12 " " " " " close wound.

14 mc.: 6 " " " " " double spaced.

$L_3$  — 1.75 mc.: 36 " No. 18 d.c.c. " close wound.

3.5 mc.: 13 " " " " " " "

7 mc.: 9 " " " " " " "

14 mc.: 6 " " " " " double spaced.

$L_1$  and  $L_2$  are wound on Hammarlund bakelite receiving plug-in forms, diameter 1 1/2 inches;  $L_3$  on Bud bakelite transmitting forms, diameter 2 1/4 inches. All amplifier coils are tapped at the center.

# The Radio Amateur's Handbook . . . . .

coils make the design flexible and adaptable to crystals on different frequency bands, and since screen-grid tubes are used, neutralization is not required. The unit is straightforward

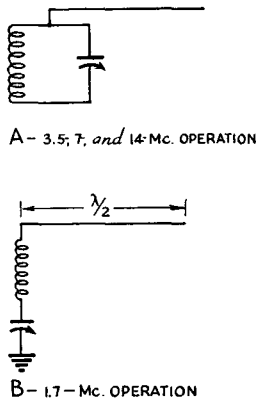

FIG. 915 — ANTENNA TUNER CONNECTIONS FOR VARIOUS BANDS

The variable condenser has a maximum capacity of 165  $\mu$ fd. (Cardwell XP-165-KS). The antenna coils for 3.5, 7 and 14 mc. are identical with the amplifier plate coils (Ls, Fig. 913) for the corresponding bands. For 1.75 mc. the number of turns required will be between 10 and 25, depending upon the length of antenna and ground leads. It is a good plan to wind a coil of 25 turns tapped at every five, with a clip for making adjustments.

to build and easy to adjust. The oscillator is a Tri-tet, using a Type 89 tube, while the second stage, which may operate either as a straight amplifier or doubler, uses an 802 or an RK-25. The circuit diagram is given in Fig. 917.

The panel measures 7 by 19 inches, the baseboard 5½ by 17 inches. The latter is supported

from the panel by brackets, and is placed so that there is about an inch of space underneath for placing of small parts and wiring. Pieces of thin wood along the edges act as supports when the unit is placed on the operating table.

The tube sockets are mounted below the baseboard, as shown in the bottom view. The three tuning condensers are symmetrically spaced, mounted on the baseboard so that their shafts project through the panel. The shaft centers are 5½ inches apart. The coil sockets are immediately behind their respective condensers; the oscillator cathode tuning condenser, C<sub>1</sub>, is at the left, oscillator plate tuning condenser, C<sub>2</sub>, in the center, and amplifier plate tuning condenser, C<sub>3</sub>, at the right. The crystal socket and 89 tube are between C<sub>1</sub> and C<sub>2</sub>.

The oscillator and amplifier circuits are similar to those described in Chapter Eight. High-C is obtained in the cathode circuit by shunting C<sub>1</sub> with a fixed mica condenser, C<sub>4</sub>. Plate, screen and suppressor voltages for the 89 are obtained from the amplifier plate supply by means of a voltage divider consisting of R<sub>3</sub>, R<sub>4</sub>, R<sub>5</sub> and R<sub>6</sub> in series. R<sub>7</sub> is the dropping resistor for the amplifier screen. The oscillator supply, amplifier screen and amplifier plate supply leads are brought out to separate terminals so that meters can be inserted in the circuits, although all three go to the positive plate supply terminal, as indicated in the diagram. The amplifier suppressor lead is brought out separately so that it may be used for keying purposes (see Chapter Ten) or for suppressor modulation (Chapter Eleven). In normal c.w. operation, or when the unit is used to excite a larger amplifier, the suppressor should be at a potential about 40 or 50 volts

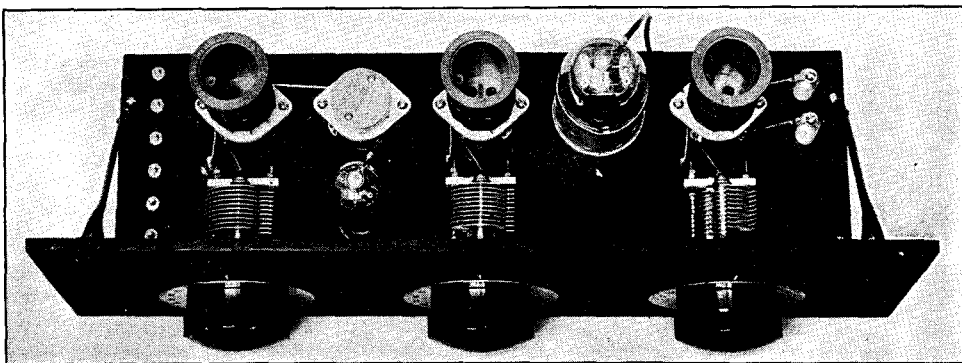

FIG. 916 — A TWO-TUBE FIVE-BAND EXCITER UNIT OR LOW-POWER TRANSMITTER

Using an 89 and 802 or RK-25, with plug-in coils. In this view the shield about the oscillator plate coil (center) has been removed to show parts and wiring. The shield about the lower part of the amplifier tube is a regular large-size tube shield cut to fit around the shield ring inside the tube.

positive with respect to the cathode; this increases the output somewhat over that obtainable with the suppressor connected directly to the cathode. Output is taken from the unit through a link winding closely coupled to  $L_3$ .

As shown in the bottom view, a sheet of thin aluminum, three inches wide, runs almost the entire length of the base-board at the rear. All grounds are made to this metal sheet, short, direct connections being used throughout. Bypass condensers should be mounted so that a short path to ground for r.f. is provided from the point in the circuit to which they are connected. Insulating lug strips are used for mounting parts which must be insulated from the metal plate. The tuning condensers, two of which are at high d.c. potential, are mounted on the insulating base-board rather than on metal so that insulation is a simple matter. The various voltage-divider and dropping resistors are mounted on insulating lug strips, away from the base so that air can circulate around them and carry off the heat. The machine screws in a row at the left in the bottom view serve as power-supply terminals. The output terminals from the link come directly from the amplifier plate coil socket to small ceramic standoffs, shown at the right in the top view.

The oscillator plate coil,  $L_2$ , must be shielded to prevent self-oscillation of the amplifier. This shield has been removed in the photograph in order to show the wiring. It is a Hammarlund shield for plug-in coils, and mounts directly on top of the socket for  $L_2$ , using the socket mounting screws to hold the

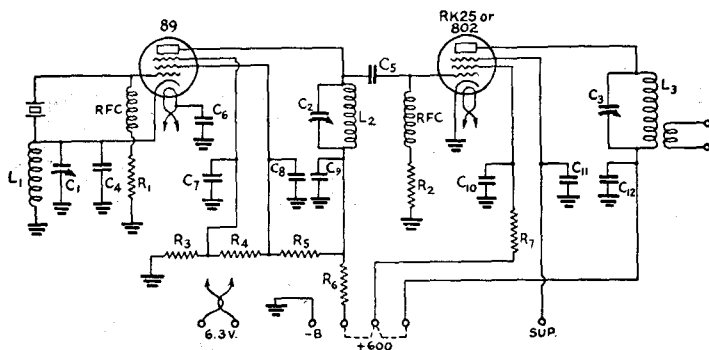

FIG. 917 — CIRCUIT DIAGRAM OF THE TWO-STAGE EXCITER UNIT

The three connections marked "600 volts" can be tied together. Oscillator plate, buffer plate and screen leads are brought out separately to facilitate metering.

- $C_1, C_2, C_3$  — 100  $\mu\text{fd.}$  (National ST-100).
- $C_4$  — 100  $\mu\text{fd.}$  mica.
- $C_5$  — 50- $\mu\text{fd.}$  mica.
- $C_6$  to  $C_9$ , inc. — 0.01- $\mu\text{fd.}$  paper, non-inductive, 400-volts (Aerovox).
- $C_{10}, C_{12}$  — .002- $\mu\text{fd.}$  paper, non-inductive, 1500-volt (Sprague).
- $C_{11}$  — .001- $\mu\text{fd.}$  mica.
- $R_3$  — 10,000 ohms, 1 watt.
- $R_4, R_5$  — 10,000 ohms, 1 watt.
- $R_6$  — 10,000 ohms, 25 watt.
- $R_7$  — 25,000 ohms, 25 watt.

$L_1$  — Oscillator cathode coil:

- For 1.75-mc. crystal: 28 turns, No. 20, close-wound.
- " 3.5 " " 14 " " 18, winding length 1 inch.
- " 7 " " 7 " " 18, " " 1 "

$L_2$  — Oscillator plate coil:

- 1.75 mc.: 65 turns No. 22, close-wound.
- 3.5 " 32 " " 18, winding length 1 1/2 inches.
- 7 " 16 " " 18, " " 1 "
- 14 " 8 " " 18, " " 1 "

$L_3$  — Buffer plate coil:

- 1.75 mc.: 65 turns No. 22, close-wound.
- 3.5 " 32 " " 18, winding length 1 1/2 inches.
- 7 " 18 " " 18, " " 1 "
- 14 " 10 " " 18, " " 1 "
- 28 " 5 " " 18, " " 1 "

All coils wound on 1 1/2-inch diameter bakelite forms (Hammarlund) with enamelled wire. Link coils on  $L_3$  consist of one or more turns, closely coupled to  $L_3$  at the bottom (cold) end; exact number must be found by experiment to give optimum loading of buffer tube.

bottom plate of the shield. The shield can lift off the bottom plate when coils are changed.

The unit may be used on three bands with any one crystal, provided its frequency is suitable for doubling and quadrupling. The cathode coil should be chosen to fit the crystal, as indicated in the coil data. For operation on the crystal frequency, both  $L_2$  and  $L_3$  will be for the same band. For doubling,  $L_1$  is chosen as before, and  $L_2$  and  $L_3$  for the next higher-frequency band. The amplifier also may be used as a doubler, in which case  $L_1$  will be at crystal frequency,  $L_2$  at twice crystal frequency, and  $L_3$  at four times crystal frequency.

The power output will depend upon the power supply voltage. With a 600 volts supply capable of delivering about 125 milliamperes,

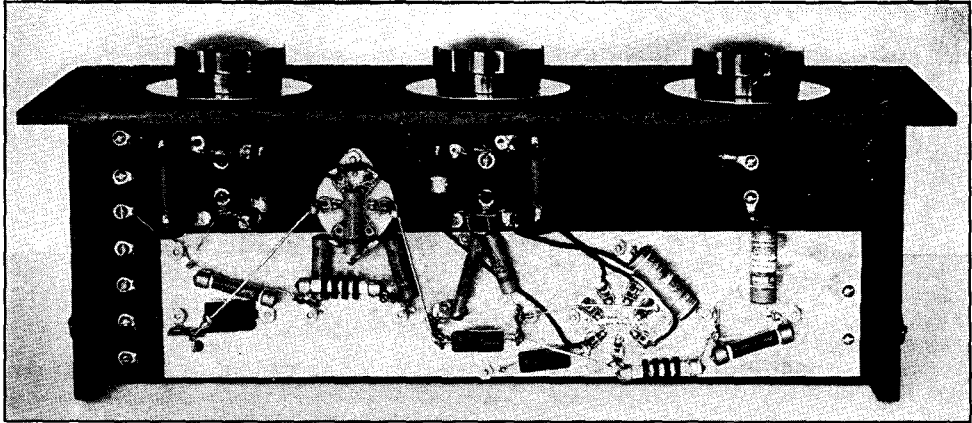

FIG. 918 — BOTTOM VIEW OF THE TWO-TUBE EXCITER

This view shows the aluminum ground plate and the disposition of bypass condensers, chokes, resistors and wiring. The interstage coupling condenser,  $C_5$  (Fig. 917) is mounted on insulating lugs below the resistor and condenser in the center. The connection, through  $C_5$  between oscillator plate and amplifier grid is made below the baseboard; this and the connection to the oscillator cathode are the only r.f. connections below the base.

an output of 20 watts can be secured when the second tube is operated as a straight amplifier. If the second tube is a doubler, the output will be about 10 watts, assuming the suppressor is about 50 volts positive. The amplifier should be loaded to take 50 or 60 milliamperes plate current. The total oscillator current should be about 25 to 30 milliamperes. With a 500-volt

supply, the output will be reduced slightly; in such case  $R_6$  should be reduced to 5000 ohms to increase the oscillator voltage.

Tuning adjustments are as described in Chapter Eight. Loading on the amplifier can be adjusted by varying the number of turns on the link and by corresponding changes at the other end of the link circuit. To work into an antenna, a link-coupled antenna-tuning unit such as that described in connection with the general-purpose 50-watt transmitter in this chapter will be suitable.

This exciter was described in October, 1936. *QST*.

#### A 60-Watt Tri-Tet Oscillator

● An example of the use of the RK20 or 804 as a medium power Tri-tet crystal oscillator is shown in Figs. 919-923, inclusive. Although a complete transmitter in itself, this set also can be used to excite a more powerful amplifier requiring grid driving power of the order of 25 to 50 watts. The construction is of the vertical open-frame type.

The transmitter can be used on three bands with crystals ground for two, 3.5 and 7 mc. Provision also is made for the use of 14-mc. crystals if available. No plug-in coils are used, band-changing being accomplished by the use of tapped coils and shorting devices. The set is capable of delivering an output of about 60 watts on the 80- and 40-meter bands and about 25 watts on 20 meters, using only 80- and 40-meter crystals. It can be used for c.w. on all three bands, break-in operation being possible,

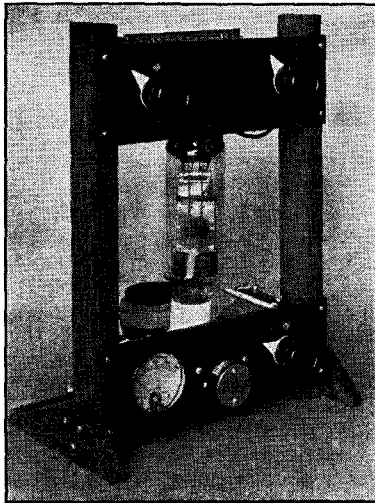

FIG. 919 — MEDIUM-POWER TRI-TET OSCILLATOR

This transmitter will give a crystal-controlled output of 60 watts on 3.5 and 7 mc. and about 25 watts on 14 mc. Its 'phone rating in the 4-mc. band is 15 watts carrier for 100% modulation.

## Building Transmitters

and for 75-meter 'phone with a suitable modulator.

The upright and cross-panel layout combines the conveniences of both breadboard and rack-type construction in that controls are panel-mounted yet all parts are readily accessible. The uprights are pieces of  $\frac{3}{4}$  by  $1\frac{1}{2}$ -inch wood, each being 13 inches high. Triangular shaped pieces of thinner wood screwed to the bottom of each upright preclude the possibility of upsetting the transmitter by accident. The panels each measure 9 by 3 inches, and are of  $\frac{3}{16}$ -inch bakelite.

The circuit diagram, Fig. 920, is the Tri-tet arranged for tapping of both plate and cathode tank coils for quick band changing. The cathode coils,  $L_1$  and  $L_2$ , are wound on a short piece of 2-inch bakelite tubing. The wire used is No. 14 d.c.c., with  $L_2$  wound on the form and  $L_1$ , which is tapped, wound right on top of  $L_2$ . The very close coupling thus obtained between  $L_2$  and  $L_1$  makes it unnecessary to tap both coils, since the short-circuited portion of  $L_1$  also short-circuits the magnetic flux about the corresponding portion of  $L_2$ . The four ends of the two windings are brought through the coil form to machine screw terminals along the

bottom edge. The drop in filament voltage through the windings is negligible.

The lower panel contains the plate milliammeter, the crystal mounting, and the cathode tank circuit tuning condenser,  $C_1$ . The crystal mounting is made by drilling two holes, of a

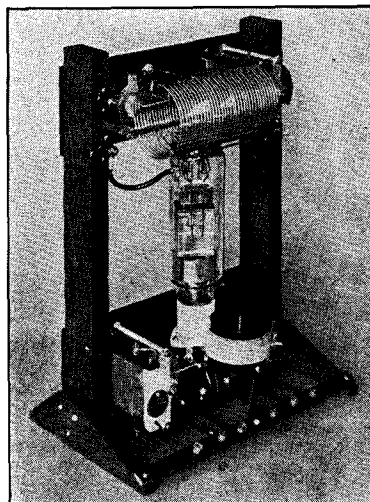

FIG. 921 — A REAR VIEW OF THE 60-WATT TRI-TET TRANSMITTER

The plate coil, at the top, is wound on a 2-inch form before being threaded through the supporting strips. The springiness of the wire makes the diameter of the finished coil  $2\frac{1}{4}$  inches.

size sufficient to pass the holder pins and the proper distance apart ( $\frac{3}{4}$  inch) in the panel, and mounting behind them a pair of pin-grips taken from a discarded wafer socket. The plate tank tuning condenser and plate-coil band-changing switch are mounted on the upper bakelite panel.

Bypass condensers and other parts are mounted on a skeleton frame made of pieces of quarter-inch square brass rod. The rear and bottom views, Figs. 921 and 922, indicate the construction. The main "girder" runs horizontally across the bottom of the transmitter. On it are mounted the plate, screen and suppressor by-pass condensers. The brass-rod frame forms a common ground and negative bus for the transmitter. The socket for the tube is set on top of two upright pieces of rod, long enough for the socket to clear the condensers underneath, fastened to the main crosspiece. The filament by-pass condensers are mounted horizontally from these uprights. Additional bracing for the socket is provided by lengths of rod which connect the uprights on which the socket is mounted with the front panel. All

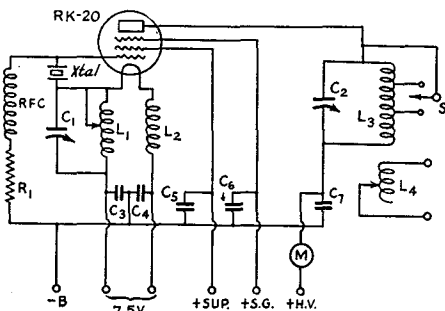

FIG. 920 — THE TRI-TET TRANSMITTER CIRCUIT DIAGRAM

- $C_1$  — 350- $\mu$ fd. variable, receiving type.
- $C_2$  — 100- $\mu$ fd. variable, transmitting type.
- $C_3, C_4$  — .005  $\mu$ d. (value not critical).
- $C_5, C_6$  — .002- $\mu$ d. mica condensers, receiver type.
- $C_7$  — .002- $\mu$ d. mica condenser, 2500- or 5000-volt rating.
- $R_1$  — 15,000 ohms, 2-watt rating.
- RFC — Short-wave choke, universal wound.
- $L_1$  — 10 turns No. 14 d.c.c. wire, close wound on 2-inch form. 7-mc. tap at 5 turns from lower (filament supply) end; 14-mc. tap at 2 turns from lower end.
- $L_2$  — Same as  $L_1$ , but without taps.  $L_1$  is wound directly over  $L_2$  on the form.
- $L_3$  — 28 turns of No. 18 bare wire, turn spacing  $\frac{1}{8}$  inch center-to-center; coil diameter  $2\frac{1}{4}$  inches; 7-mc. tap 12 turns from plate end. 14-mc. tap 23 turns from plate end.
- $L_4$  — 6 turns same as  $L_3$ .  $L_4$  is a continuation of  $L_3$ , the wire being cut at the appropriate turn.
- M — 0-200 milliammeter.

# The Radio Amateur's Handbook . . . . .

power leads (properly insulated) are run through holes drilled in the crosspiece and go to the rear of the set where they connect to the terminal strip. The cathode coil assembly is

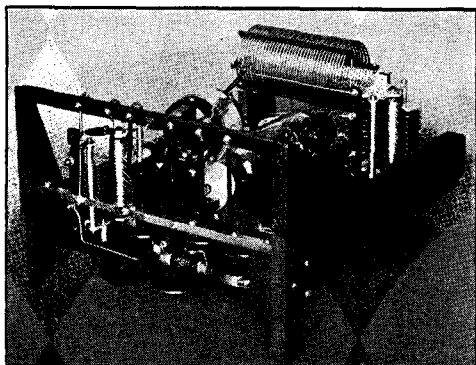

FIG. 922 — A BOTTOM VIEW OF THE TRI-TET TRANSMITTER

*By-pass condensers are mounted on the brass-rod supporting structure.*

*The resistor near the panel is the grid leak. The grid choke is fastened by its pigtail connections between the grid prong on the tube socket and one end of the leak.*

held in place by short pieces of copper strip which serve both as connections and mechanical braces between the lower coil terminals and the filament by-pass condensers.

The plate tank coil,  $L_3$ , is mounted between the plate tuning condenser and the left-hand wooden upright (rear view) by means of brass

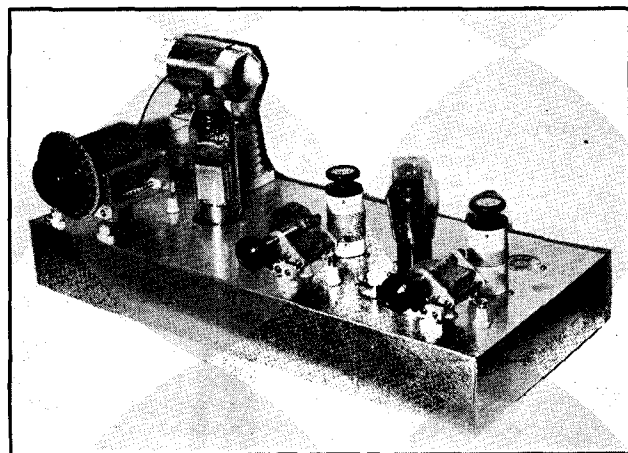

FIG. 924 — A THREE-BAND TWO-STAGE PENTODE TRANSMITTER

*A 59, pentode or Tri-tet, drives an RK-20 or 804 amplifier, using 3.5- and 7-mc. crystals. No buffer stages are needed. This outfit was built by WIAF.*

pieces. The coil is wound of No. 14 bare wire threaded into strips of thin bakelite previously drilled to give the desired turn spacing ( $\frac{1}{8}$ -inch center to center). The method of making coils of this type is described earlier in this chapter. The wire is cut six turns in from one end to provide an output coupling coil insulated from the plate coil. The coupling coil is at the "dead" end of the plate coil to avoid capacity effects and reduce harmonic transfer, the turns being shorted from the plate or "hot" end.

The shorting switch has three contacts, only two of which are used, the unconnected

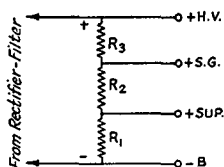

FIG. 923 — SUGGESTED VOLTAGE DIVIDER FOR SUPPLYING SCREEN AND SUPPRESSOR VOLTAGES FROM 1000-VOLT PLATE SUPPLY

$R_1$  — 2500 ohms, 5-watt rating.

$R_2$  — 12,500 ohms, 25-watt or higher rating.

$R_3$  — 12,500 ohms, 40-watt rating.

*The resistors may be standard units of the values specified, or individual adjustment may be made to the voltages by using variable resistors of the type having sliding taps.*

tap being the 80-meter position, when the whole of the tank coil is used.

Assuming a 3.5-mc. crystal is to be used, set the switch in the open position, leave the cathode-coil clip floating, and turn  $C_1$  down

from maximum until the plate current drops, indicating that oscillations have started. Continue to decrease the capacity of  $C_1$  until the plate current rises to a maximum and then adjust  $C_2$  for the plate current dip which indicates resonance. With  $C_1$  at about half scale the off-resonance plate current will be 100 milliamperes or more; at resonance it should drop to about 20 ma. The antenna may then be coupled and its tuning circuits adjusted for maximum output. After the antenna is tuned,  $C_2$  and  $C_1$  should be re-adjusted to determine the optimum settings. An antenna coupler of the type shown in Figs. 932 and 933 may be used with this transmitter.

For operation on the second harmonic the procedure is the

# Building Transmitters

same except that the plate-coil switch is set on the 7-mc. tap. The dip in plate current when  $C_2$  is adjusted to resonance will not be so great as when the output is on the fundamental frequency of the crystal nor will the output be as high. Also, a slightly higher-capacity setting of  $C_1$  will give greater output on the harmonic.

To use the set with a 7-mc. crystal, both the plate switch and the cathode-coil clip should be set on the proper taps. The tuning procedure is identical with that just described. The second-harmonic plate current dip on 20 is comparatively small and the output drops to about

volts at 40 ma. for the screen, and 50 volts at negligible current for the suppressor. A suitable voltage divider to supply screen and suppressor currents from the high-voltage source is suggested in Fig. 923.

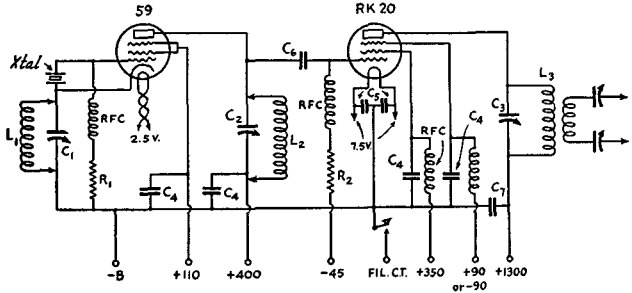

FIG. 925 — CIRCUIT DIAGRAM OF THE TWO-STAGE PENTODE TRANSMITTER

- $C_1$  — 250- $\mu$ fd. cathode tuning condenser (National TMS-250).
- $C_2$  — 100- $\mu$ fd. oscillator plate condenser (National TMS-100).
- $C_3$  — 150- $\mu$ fd. amplifier plate condenser (National TMC-150).
- $C_4$  — .002- $\mu$ fd. mica condenser, receiving type (Sangamo).
- $C_5$  — .004- $\mu$ fd. mica condenser, receiving type (Sangamo).
- $C_6$  — 100- $\mu$ fd. mica condenser, receiving type (Sangamo).
- $C_7$  — .002- $\mu$ fd. mica condenser, 5000-volt (Sangamo).
- $R_1$  — 50,000 ohms, 2-watt rating (I.R.C.).
- $R_2$  — 15,000 ohms, 2-watt rating (I.R.C.).
- RFC — S.w. chokes (National Type 100).

See separate table for coil data.

Antenna tuning equipment will depend upon the type of antenna system used. With series tuning of Zepp feeders, tuning condensers of 250- $\mu$ fd. each will be satisfactory.

### A Two-Stage Transmitter

● A complete transmitter of moderate output, simple in construction, can be built by using tubes which give full output with low grid driving power such as the screen-grid pentodes. The transmitter shown in Fig. 924 is an example. The metal-chassis type of construction is illustrated.

The transmitter consists of but two tubes — a 59 pentode-Tri-tet oscillator, and an RK-20 or 804 amplifier. With 3.5- and 7-mc. crystals, it can work in any of three bands, and can be used for either c.w. or 'phone, giving up to 100 watts output on the former and approximately 20 watts carrier (suppressor-grid modulation) on the latter. The small number of tubes and stages reduces operating complications to a minimum; thus band-changing becomes relatively simple. Provision for using the oscillator electron-coupled for output on 7 and 14 mc. also is built into the set, so that frequency

COIL TABLE				
Coil	Turns	Length of Winding	Tap	Wire Size
A	35	1 1/4	4	No. 22 d.c.c.
B	15	1 1/4	2	No. 18 bare
C	7	5/8		"
D	6	5/8		"
E	21	*		No. 12 bare
F	17	**		"
G	6			"

OPERATION WITH CRYSTAL CONTROL				
Output	$L_1$	$L_2$	$L_3$	Crystal
3.5 mc.	$C_1$ shorted	Coil A	Coil E	3.5 mc.
7 mc.	$C_1$ shorted	Coil B	Coil F	7 mc.
14 mc.	Coil C	Coil D	Coil G	7 mc.

ELECTRON COUPLED			
Output	$L_1$	$L_2$	$L_3$
7 mc.	Coil A	Coil B	Coil F
14 mc.	Coil B	Coil D	Coil G

Electron-coupled control not used on 3.5 mc. Coils A, B, C and D wound on Hammarlund Isolantite forms.

\* Coils for amplifier plate wound on G.R. Forms, 2 1/2-inch diameter, 7 grooves per inch.

\*\* Coil E actually is used, a tap being taken off at 17 turns.

25 watts. A 14-mc. crystal can be used if the cathode clip is set on the proper tap. The output should be higher than when doubling from a 7-mc. crystal.

Before the tuning operations are attempted, the section on Tri-tet oscillators in Chapter Eight should be read carefully.

This transmitter requires a power supply delivering 7.5 volts at 2 amperes for the filament, 1000 volts at 80 ma. for the plate, 300

# The Radio Amateur's Handbook . . . . .

changes within a band can be made quickly and easily.

A cadmium-plated steel chassis is the foundation; its dimensions are 23 by 10 by 3 inches, allowing ample room and a reasonable space

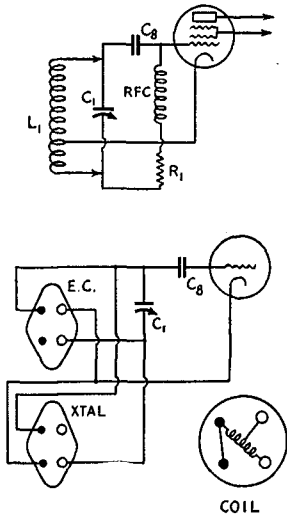

FIG. 926 — ALTERNATIVE OSCILLATOR GRID CIRCUIT CONNECTIONS FOR SELF-CONTROLLED OPERATION

Shifting the cathode coil to an appropriate socket and plugging in either a crystal or grid condenser gives a choice of either crystal or electron-coupled operation. The grid condenser,  $C_8$ , is a 250- $\mu\text{fd}$ . receiving-type mica condenser.

between oscillator and amplifier so that inter-stage shielding is unnecessary.

All sockets are Isolantite wafer type. Three 4-prong sockets are required, for the e.c. cathode coil, Tri-tet cathode coil and plate coil, respectively. One 7-prong socket, for the 59, and one 5-prong, for the crystal mounting, also are needed. The amplifier uses another 5-prong socket, making six in all. The oscillator coils are wound on Hammarlund Isolantite coil forms, the amplifier coils on General Radio forms.

The variable condensers are mounted on a combination of tinymite stand-offs and feed-throughs of the same height. In the case of the oscillator tuning condensers, the forward ends are supported by stand-offs, the rear by the small feed-throughs. The rotor connections are made to these feed-throughs. Because none of the condensers are worked at ground potential, feed-through insulators are mounted adjacent to the rear condenser feed-through supports to carry the stator connections through the chas-

sis. The amplifier tank condenser is supported on three legs by stand-offs and the fourth leg by a feed-through. The amplifier coil forms are provided with small G.R. plugs and the large stand-off insulators supporting the tank coil are fitted with G.R. jacks to facilitate coil changing.

The amplifier tube is mounted vertically through the chassis. A hole large enough to give  $\frac{1}{8}$  inch clearance for the tube is cut in the chassis; the 5-prong socket is mounted on the bottom of a small aluminum box, open at the top and fastened to the chassis underneath the hole for the tube. The height of the box is just sufficient to bring the tube's internal shield (the cylindrical plate near the bottom of the envelope) flush with the top of the chassis. This provides a simple buffer shield between the input and output elements of the tube.

On 3.5 mc. and 7 mc. the oscillator is operated as a straight pentode, the cathode coil being shorted. This is done by bending over a corner of one rotary plate of  $C_1$  so it touches the stator when set at full capacity. Two crystals (3.5 and 7 mc.) are needed for operation on three bands, 3.5, 7 and 14 mc. On 14 mc. the oscillator is operated Tri-tet, doubling in the plate circuit of the 59. Two coils are used in the amplifier; one exclusively on 14 mc. the other for 3.5 and 7 mc. A small copper clip, with its jaws slightly extended, shorts out 4 turns of the 3.5 mc. tank coil very handily and permits very low  $C$  operation of the tank at 7 mc. Without the clip, approximately 85  $\mu\text{fd}$ . tunes the combination to 3.5 mc. It is but a matter of seconds to shift bands with this line-up.

Any of the speech-amplifier modulator combinations described in Chapter Twelve capable of delivering audio power of the order of a watt or so will fully modulate the output for 'phone operation. Adjustment for complete modulation is described in Chapter Eleven.

Typical operating conditions are 400 volts plate and 110 volts screen on the 59; 1000 to 1250 volts plate and 350 volts screen on the amplifier; grid bias to the amplifier, 45 negative by battery to limit plate current without excitation plus a grid leak of 15,000 ohms; optimum grid current 5 to 6 mils. Plate current to the 59 oscillator is of the order of 20 to 25 ma.; to the amplifier 100 ma. on c.w. Tuning adjustments are made as described in Chapter Eight.

## A General-Purpose 50-Watt Transmitter

● A transmitter for operation in five bands, in which several types of tubes may be used according to the wishes of the operator, is shown in Figs. 927-930, inclusive. Breadboard



## • • • • • Building Transmitters

and panel mounting are combined in its construction.

This transmitter is a three-stage outfit having a pentode crystal oscillator, a second stage which operates either as a self-neutralized straight amplifier or as a back-to-back doubler, and a permanently-neutralized push-pull final amplifier stage using 801's, 10's or 830's. A separate antenna-tuning unit transmission-line coupled to the transmitter, also is provided.

The circuit diagram of the transmitter is given in Fig. 930. The oscillator uses the regular pentode circuit with a Type 2A5 tube. Its plate tuned circuit,  $L_1C_1$ , is coupled inductively to the tuned and balanced grid circuit of the second stage,  $L_2C_{11}$ . In this stage a pair of 2A5 tubes is arranged with the grids in push-pull and the plates in parallel. A switch,  $Sw_1$ , is cut in one heater leg of one of the tubes; when it is open this tube does not operate but simply serves as a neutralizing capacity for the other for operation on the same frequency as the oscillator. For doubling,  $Sw_1$  is closed, whereupon the two tubes work

together to produce second-harmonic output. The output circuit is tuned by  $C_2L_3$ , the inductance  $L_3$  being coupled to  $L_4$ , the final amplifier grid coil.

The grid coil of the final stage is, in all cases except one, tuned only by the tube and circuit

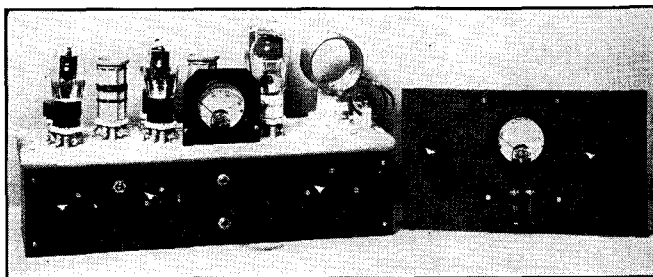

FIG. 927 — A GENERAL VIEW OF THE 50-WATT TRANSMITTER AND THE ANTENNA TUNING UNIT

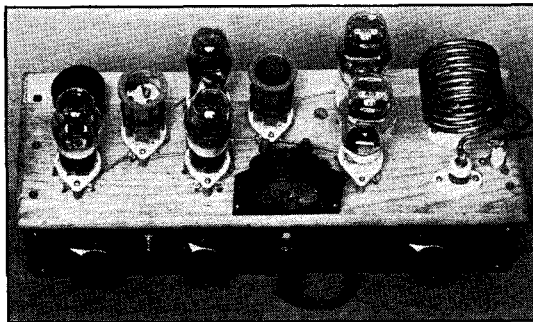

FIG. 928 — THIS PLAN VIEW OF THE TRANSMITTER SHOWS THE LAYOUT ABOVE THE BASEBOARD

*Coils for all stages are plug-in to facilitate frequency changing and the use of crystals ground for different bands. The final stage neutralizing condensers are screwdriver-adjusted, through the holes in the baseboard just to the left of the tubes. The coils shown are for straight-through operation from a 14-mc. crystal.*

capacities and its own distributed capacity. The single exception is the 1750-kc. coil, where the physical dimensions of such a coil would be so large as to make the untuned coil impracticable with ordinary coil forms. Therefore for this band only an auxiliary condenser,  $C_{12}$ , is used to tune the grid circuit.

The plate circuit of the final stage uses a split-stator condenser with grounded rotor. The plate coil is tapped at the center and fed d.c. through an r.f. choke. The amplifier is cross-neutralized, and because of the grounded-condenser plate circuit will be neutralized for all frequencies once the neutralizing adjustments have been correctly made on the first frequency tried. A pair of clips tapping on the amplifier tank coil provide for transferring the r.f. output to the antenna tuner.

Grid-leak bias is used on all three stages. A combina-

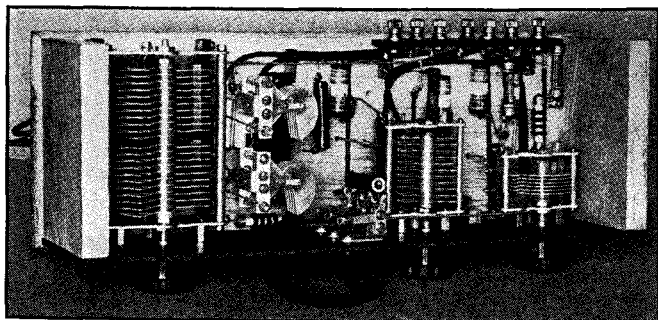
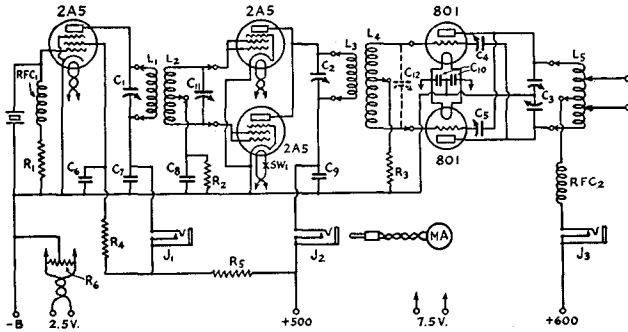

FIG. 929 — BELOW THE BASEBOARD AND BEHIND THE CONTROL PANEL

# The Radio Amateur's Handbook . . . . .

tion of battery and leak bias might be used on the last stage, the battery being for protective purposes. The 2A5's in the second stage need no protection of this type, since their plate current drops to a very low value if excitation fails. These tubes are not used as

small bakelite panel, and the output terminal standoffs. The progression is from left to right; the oscillator tube is at the extreme left front, with the crystal socket directly behind it. Next is the plug-in coil for the oscillator plate, then the two tubes in the second stage, followed by the plate coil for that stage, then the amplifier tubes, the standoff-sockets for the amplifier tank coils, and finally the output posts.



The panel controls, from left to right, are the oscillator tuning condenser, on-off switch, *Sw*<sub>1</sub> second-stage tuning condenser, plate current jacks, and finally the amplifier tuning condenser.

In the bottom view of the transmitter the order is reversed. The oscillator tuning condenser, *C*<sub>1</sub>, is at the right, mounted on

FIG. 930 — CIRCUIT DIAGRAM OF THE TRANSMITTER

- C*<sub>1</sub> — 100- $\mu$ fd. variable (Cardwell Type MR-105-BS).
  - C*<sub>2</sub> — 100- $\mu$ fd. variable (Cardwell Type MT-100-GS).
  - C*<sub>3</sub> — 100- $\mu$ fd. (net) split-stator transmitting condenser (Cardwell Type XT-210-PD).
  - C*<sub>4</sub>, *C*<sub>5</sub> — 25- $\mu$ fd. variables, transmitting type National SEU-25).
  - C*<sub>6</sub>, *C*<sub>7</sub>, *C*<sub>8</sub>, *C*<sub>9</sub>, *C*<sub>10</sub> — .002- $\mu$ fd. paper by-pass condensers, 1500-volt transmitting type (Sprague Type SW-22).
  - \**C*<sub>11</sub> — Air-padding condensers; for 1.75-mc. coil, 100  $\mu$ fd. (Hammarlund APC-100); for 3.5, 7, and 14 mc., 50  $\mu$ fd. each (Hammarlund APC-50).
  - \**C*<sub>12</sub> — 100- $\mu$ fd. air padding condenser (Hammarlund APC-100), used only on 1.75-mc. coil.
  - R*<sub>1</sub> — 5000 ohms, 2-watt (I.R.C.).
  - R*<sub>2</sub> — 1250 ohms, 5-watt (I.R.C.).
  - R*<sub>3</sub> — 10,000 ohms, 5-watt (Ward-Leonard 507-206).
  - R*<sub>4</sub> — 50,000 ohms, 2-watt (I.R.C.).
  - R*<sub>5</sub> — 5000 ohms, 15-watt (Ward-Leonard 507-341).
  - R*<sub>6</sub> — 20 ohms, center-tapped.
  - RFC*<sub>1</sub>, *RFC*<sub>2</sub> — High-frequency chokes (National Type 100).
  - J*<sub>1</sub>, *J*<sub>2</sub>, *J*<sub>3</sub> — Single circuit-closing jacks.
  - Sw*<sub>1</sub> — S.p.s.t. toggle switch.
  - MA* — 0-300 d.c. milliammeter.
- Winding data on coils is given in the Table.
- \* Mounted in coil forms.

the panel. Just above it in the photograph are the r.f. choke *RFC*<sub>1</sub> and the resistor, *R*<sub>1</sub>, in the oscillator grid circuit. A little to the left of these components are the screen by-pass condenser, *C*<sub>6</sub>, and dropping resistor, *R*<sub>4</sub>; beside them to the left is the oscillator plate by-pass condenser, *C*<sub>7</sub>. All by-pass condensers in the set are of the tubular paper type made for transmitting use.

The tubular variable condenser in line is the second-stage tuning condenser, *C*<sub>2</sub>, also mounted on the panel. Between this and the oscillator condenser is the toggle switch, *Sw*<sub>1</sub>. The condenser and resistor just above *C*<sub>2</sub> are the grid resistor *R*<sub>2</sub> and by-pass condenser *C*<sub>8</sub>. The filament center-tap resistor, *R*<sub>6</sub>, is mounted on the baseboard behind *C*<sub>2</sub>.

The resistor mounted on the two nearer jacks is the oscillator plate dropping resistor, *R*<sub>5</sub>. Above the jacks on the baseboard are the plate by-pass condenser *C*<sub>9</sub> and the amplifier grid resistor, *R*<sub>3</sub>.

The two neutralizing condensers, *C*<sub>4</sub> and *C*<sub>5</sub>, are mounted on a 1- by 4-inch bakelite strip elevated about a half-inch from the baseboard. The condenser shafts, which are slotted by a hacksaw, project through half-inch holes in the baseboard so they can be adjusted with a screwdriver from the top. The filament by-pass condensers, *C*<sub>10</sub>, for the final stage are fastened to the baseboard underneath the neutralizing condensers, as is also the amplifier plate choke, *RFC*<sub>2</sub>.

The split-stator tuning condenser for the final stage is at the extreme left. All power leads are brought to the terminal strip at the upper right. Bus bar is used for the r.f. wiring, while the filament circuits are wired with heavy flexible rubber-covered wire.

pentodes but as Class-B triodes, the control grid and screen in each tube being tied together.

Plate power for the oscillator is secured from the second-stage supply through a dropping resistor, *R*<sub>5</sub>. A second dropping resistor, *R*<sub>4</sub>, reduces the voltage to the right value for the oscillator screen. Jacks are provided in all three circuits for measuring plate currents.

The fixed apparatus on top of the baseboard consists almost exclusively of sockets of various descriptions into which tubes, coils and crystals can be inserted. The exceptions are the plate milliammeter, which is mounted on a

## • • • • • Building Transmitters

The overall dimensions of the transmitter (with tubes in place) are 18½ by 11 by 8 inches. The control panel measures 18 by 4 inches and the baseboard 18½ by 6½ inches.

Complete winding data for the coils are given in the Table.

The oscillator plate and buffer grid windings,  $L_1$  and  $L_2$ , are on the same form. A buffer grid tuning condenser,  $C_{11}$ , is mounted inside each coil form. These condensers are adjusted by means of a screwdriver when the set is in operation. One setting will suffice for work in any one band. The grid circuit  $L_2C_{11}$  is tuned to a frequency considerably higher than that of the crystal; it cannot be tuned to resonance with the circuit  $L_1C_1$  because of the tight coupling between  $L_1$  and  $L_2$ .

The buffer plate coils and amplifier grid coils are wound on the same type of form. In this case the grid coils are untuned, being wound to be self resonant, except for the 1.75-mc. coil. This grid coil is tuned by a 100- $\mu\mu$ fd. air-dielectric midget. All other coils are wound to be resonant at a frequency slightly below the particular band for which they are designed. In winding the grid coils, care should be taken to have the same number of turns each side of the center tap, otherwise the circuits may not neutralize properly.

Specifications for the amplifier plate coils also are given in the Table. The coils for the 1.75- and 3.5-mc. bands are wound with enamelled wire on celluloid strips

as described earlier in this chapter. The ends of the coils are looped around G.R. plugs for the two outer connections. The center tap is made by cutting off most of the threaded shaft of a similar plug and soldering it directly to the center turn.

The 7-mc. plate coil is made of ¼-inch copper tubing. Lugs made from 3/16-inch tubing slip over the ends of the winding and are flattened and drilled so the plugs can be bolted in place. The center plug is fastened to a small

Band		1.75 mc.	3.5 mc.	7 mc.	14 mc.	28 mc.
Oscillator $L_1$	No. of turns...	55	31	18	7	
	Wire size.....	No. 26	No. 18	No. 18	No. 18	
	Length of winding (in.)	0.850	1.300	0.750	0.300	
	Space between $L_1$ - $L_2$ (in.)	0.250	0.300	0.300	0.400	
$L_2$	No. of turns...	40	26	12	6	
	Wire size.....	No. 26	No. 26	No. 26	No. 26	
	Length of winding (in.)	0.600	0.400	0.175	0.100	
Buffer $L_3$	No. of turns...	50	26	16	6	3
	Wire size.....	No. 26	No. 18	No. 18	No. 18	No. 18
	Length of winding.....	0.850	1.150	0.650	0.250	0.100
	Space between $L_3$ - $L_4$ .....	0.100	0.200	0.250	0.400	0.500
$L_4$	No. of turns...	80	60	28	12	6
	Wire size.....	No. 26	No. 30	No. 26	No. 26	No. 26
	Length of winding.....	1.250	0.600	0.425	0.180	0.200
Amplifier $L_5$	No. of turns...	44	26	16	8	4
	Wire size.....	No. 14	No. 12	½" t.	3/16" t.	3/16" t.
	Length of winding.....	3.75	3.5	4.0	2.5	2.5

Oscillator and buffer coils are wound on Hammarlund Type XP-53 coil forms, diameter 1½ inches. Amplifier coils are self-supporting, inside diameter 2½ inches.

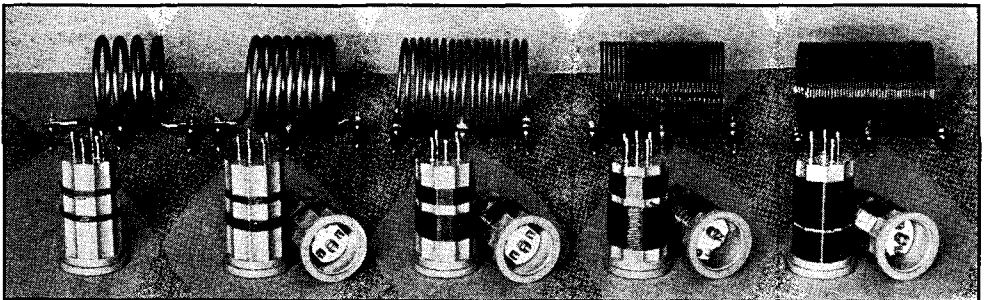

FIG. 931 — A COMPLETE SET OF COILS FOR OPERATION IN FIVE BANDS WITH CRYSTALS GROUND FOR FOUR BANDS

For working in two bands with a single crystal, only five coils will be needed, one for the oscillator, two for the buffer-doubler and two for the final amplifier. Other combinations readily can be worked out.

The coils are grouped according to frequency. The air padders can be glimpsed in the ends of the oscillator coils, lying on their sides.

strip of copper which is formed around the center turn and soldered in place. These expedients are necessary because the tubing is too thin to permit drilling to pass the plug shanks.

The 14- and 28-mc. coils are wound with 3/16-inch tubing with the ends bent and flattened to fit the sockets. The center taps are made simply by drilling through the center turn and bolting the plug in place.

## Antenna Tuning Unit

● The antenna tuner is mounted on a 7 by 12 bakelite panel. The two tuning condensers,  $C_{13}$  and  $C_{14}$ , are at opposite ends of the panel with

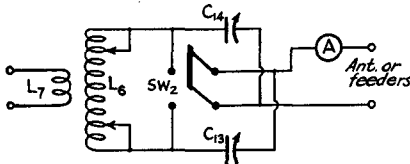

FIG. 932 — WIRING OF THE ANTENNA TUNER  
 $C_{13}$ ,  $C_{14}$  — 300- $\mu$ fd. variables (National Type TMS-300).

$Sw_2$  — D.p.s.t. knife switch.

A — Antenna ammeter, 0-2.5 amp.

$L_6$  — 24 turns No. 12 enamelled wire, turns spaced to occupy a winding length of 3½ inches, coil diameter 2 inches, tapped as described in text.

$L_7$  — 2 turns No. 12 enamelled wire, diameter 2½ inches. With  $Sw_2$  open, tuning condensers are in series with  $L_6$ , with  $Sw_2$  closed, in parallel.

the tuning coil,  $L_6$ , mounted between them on National Type GS-1 insulators. A pair of similar insulators at the lower edge of the panel serves as input terminals and as supports for the coupling coil,  $L_7$ , which is concentric with  $L_6$ . The method of construction of  $L_6$  is identi-

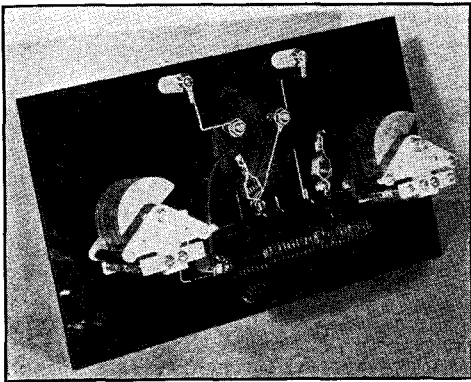

FIG. 933 — A REAR VIEW OF THE ANTENNA TUNER

This unit may be mounted on a wall or beside the window through which the feeders enter.

cal with that of the 3.5-mc. amplifier tank coil. Taps are made by soldering wire "ears" to the turns. There are four taps, the first pair being four turns in from the ends of the coil, and the second pair four turns in from the first. The output terminals to the feeders or antenna system are at the top of panel. A double-pole single-throw switch for changing the tuning condensers from series to parallel is mounted on the front panel just below the r.f. ammeter.

Small copper spring-clips are used to make connections to the taps on the coil  $L_6$  and also to the amplifier tank coil,  $L_5$ .

Tuning and neutralizing adjustments are in general as described in Chapter Eight. The one special adjustment is that of tuning the grid circuit of the second stage. Starting with  $C_{11}$  at minimum, and with  $L_3$  out of its socket, the plate voltage should be applied to the oscillator and  $C_1$  adjusted for oscillation. The capacity of  $C_{11}$  then should be increased in small steps, with corresponding readjustments of  $C_1$ , until the oscillator is drawing about 25 ma. with  $C_1$  set in the optimum operating region as described in Chapter Eight.  $L_3$  may then be plugged in and the doubler adjusted to resonance, bearing in mind the use of  $Sw_1$  in connection with straight amplification and doubling. The other adjustments are carried out in the regular way.

With applied voltages as indicated, the oscillator plate current should be 20 to 25 ma., second stage, 50 to 100 ma. depending on the band in use and whether the stage is used as an amplifier or doubler, and up to 150 ma. on the final stage when loaded. Adjustment of the antenna coupling unit also is described in Chapter Eight.

## A 100-watt 3.5- and 7-mc. Transmitter

● When transmitter cost is balanced against results, it will be found that the optimum power output is in the vicinity of 100 watts. A transmitter which will give this power output on the three most popular bands, 3.5, 7 and 14 mc., is illustrated in Figs. 934 and 936. Some measure of flexibility is achieved by the fact that it is capable of working on all three bands with but one 3.5-mc. crystal, although an additional 7-mc. crystal can be used to produce greater power output on 14 mc. than is possible with the 3.5-mc. crystal. A number of features described in Chapter Eight are incorporated in this transmitter. The circuit diagram is shown in Fig. 935.

The oscillator tube is a 6L6, connected as a Tri-tet. Either a 203-A or 211 may be used in the neutralized final stage. The coupling circuit between the oscillator and amplifier will

# Building Transmitters

be recognized as one of those described in the section on interstage coupling in Chapter Eight; it is particularly applicable in this case because it avoids shunting the rather large input capacity of the final tube across the whole of the oscillator plate tuned circuit. The oscillator tank is split into two parts, the oscillator output capacity being across one section of the split-stator tuning condenser,  $C_2$ , and the input capacity of the 203-A or 211 being across the other section. To get series feed for both oscillator plate and amplifier grid, the oscillator tank coil,  $L_2$ , is wound in two sections, the inner ends of the windings being connected through the bypass

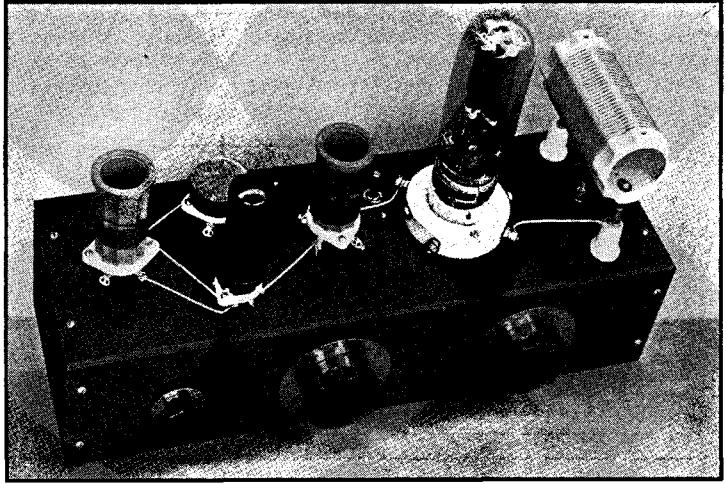

FIG. 934 — A TWO-STAGE 100-WATT TRANSMITTER FOR THREE BANDS

A 6L6 Tri-tet oscillator drives a 211 or 203A amplifier. The oscillator cathode coil is at the left, followed in order by the oscillator tube and crystal socket, then the oscillator plate coil, amplifier tube and amplifier plate coil. The small dial at the left on the panel is cathode tuning. Oscillator plate tuning control is in the center, amplifier plate dial at the right.

condenser  $C_6$ . The radio-frequency chokes in the plate and grid supply leads are necessary to isolate the oscillator plate power supply and amplifier grid bias supply from the tuned circuit; without these chokes there might be a tendency for r.f. to wander into the supplies.

In the amplifier plate circuit, neutralizing with a split-stator condenser is used. With tubes of this type, the rather large output capacity shunting one section of the plate tank condenser ( $C_3$  in the diagram) tends to upset the neutralizing balance at different settings of the conden-

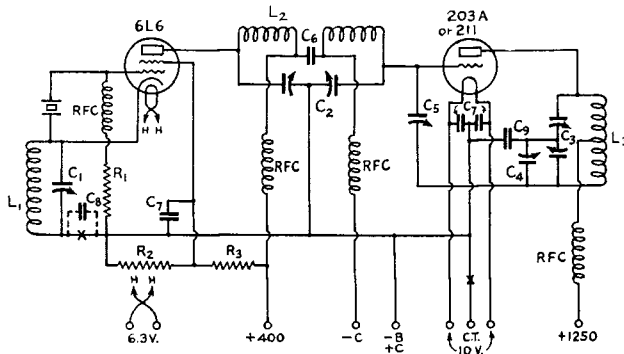

FIG. 935 — CIRCUIT DIAGRAM OF THE 100-WATT TRANSMITTER

- $C_1$  — 200- $\mu$ fd. midget condenser (Hammarlund MC-200-M).
- $C_2$  — Split-stator, 150  $\mu$ fd. per section (Cardwell MR-150-BD).
- $C_3$  — Split-stator, 210  $\mu$ fd. per section (Cardwell XT-210-PD).
- $C_4, C_5$  — 25- $\mu$ fd. double-spaced midget (National SEU-25).
- $C_6$  — .0005- $\mu$ fd. mica, 2500-volt rating (Sangamo).
- $C_7, C_8$  — .005- $\mu$ fd. mica, receiving type.
- $C_9$  — .002- $\mu$ fd. mica, 5000-volt rating (Aerovox).
- $L_1$  — 3.5-mc. crystal: 11 turns No. 18 enamelled on  $1\frac{1}{2}$ -inch diameter form; winding length  $\frac{7}{8}$  inch.
- 7 mc. crystal: 6 turns No. 18 enamelled on  $1\frac{1}{2}$ -inch diameter form; winding length  $\frac{1}{2}$  inch.

- $L_2$  — Wound on  $1\frac{1}{2}$ -inch diameter forms, coils separated in center by  $\frac{1}{4}$ -inch space. Figures are number of turns per section; two sections to each coil.
  - 3.5 mc.:  $18\frac{1}{2}$  turns No. 22 enamelled, winding length 1 inch.
  - 7 mc.:  $9\frac{1}{2}$  turns No. 18 enamelled, winding length  $\frac{3}{4}$  inch.
  - 14 mc.: 5 turns No. 18 enamelled, winding length  $\frac{1}{2}$  inch.
- $L_3$  — Wound with No. 14 tinned wire on National XR-10-A forms (diameter  $2\frac{1}{4}$  inches, 7 turns per inch).
  - 3.5 mc.: 26 turns; 7 mc., 14 turns; 14 mc., 8 turns.
- $R_1$  — 250,000 ohms,  $\frac{1}{2}$  watt.
- $R_2$  — 30,000 ohms, 2 watt.
- $R_3$  — 20,000 ohms, 10 watt.
- RFC — High-frequency r.f. choke (National Type 100).

# The Radio Amateur's Handbook . . . . .

ser, hence an auxiliary condenser,  $C_4$ , is shunted across the other condenser section to balance the output capacity of the tube.

Other circuit values are typical for the types of tubes used. The voltage divider for the screen

whether working at the crystal frequency or doubling. Amplifier grid current should be approximately 15 to 20 milliamperes. With the antenna coupled, the amplifier may be loaded to draw about 150 ma. at resonance.

With a 3.5-mc. crystal, the oscillator may be worked as a straight pentode feeding the amplifier, also on 3.5 mc. The Tri-tet circuit also may be used for this type of operation,  $C_1$  being adjusted to give maximum output consistent with low r.f. current through the crystal. This may be judged by the glow of a neon lamp touched to the grid prong on the 6L6 socket; more than a faint glow may give undue crystal heating. For 7-mc. out-

put with a 3.5-mc. crystal, the oscillator is used as a Tri-tet with its plate circuit tuned to the second harmonic; the amplifier output circuit is likewise tuned to 7 mc. The amplifier may be used as a doubler to 14 mc. with the same oscillator tuning; an output of about 50 watts can be realized with this arrangement. Better effi-

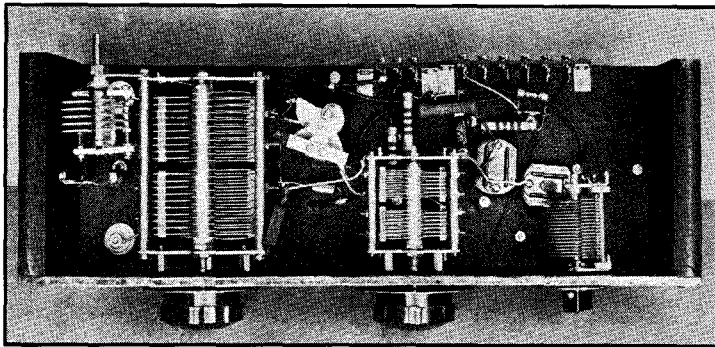

FIG. 936 — A BELOW-BASE VIEW OF THE 100-WATT TRANSMITTER

The small variable mounted to the left of the amplifier plate tank condenser,  $C_3$ , is the balancing condenser  $C_4$ . The neutralizing condenser,  $C_5$ , is on the other side of  $C_3$ . Bypass condensers, chokes and resistors are placed at convenient points.

of the 6L6 consists of the resistors  $R_2$  and  $R_3$  in series. The oscillator can be used as a straight pentode, if desired for straight-through operation, by shorting out  $C_1$ , the cathode tuning condenser. The arrangement described in the 6L6 transmitter earlier in the chapter can be used for this purpose.

The key may be inserted at either of the points marked "X" in the circuit diagram. If the crystal circuit is keyed, the bypass condenser  $C_3$  must be used, and fixed bias (about 90 volts) is required on the amplifier to hold the plate current to a safe value when the key is open. The set also may be keyed in the amplifier filament center-tap, in which case the amplifier may be wholly leak-biased.

The adjustment of the Tri-tet oscillator, as well as amplifier tuning and neutralizing adjustments, are covered in Chapter Eight. The oscillator plate current should be about 80 ma. (loaded) on all bands,

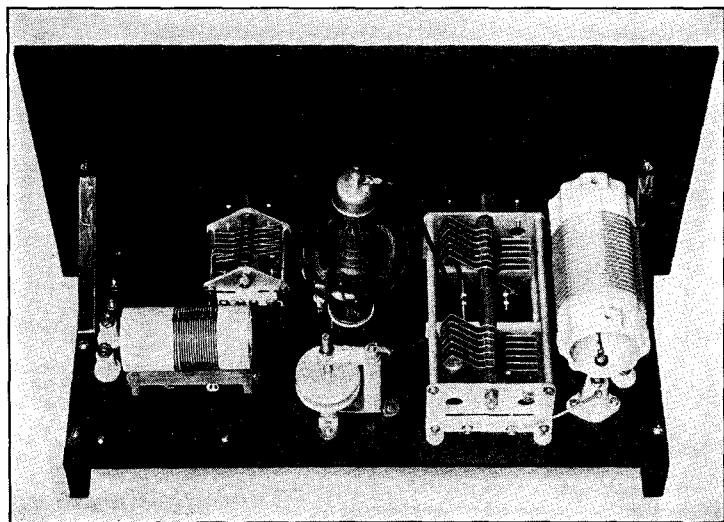

FIG. 937 — A SINGLE-TUBE HIGH-FREQUENCY AMPLIFIER OF MEDIUM POWER

For use on 7, 14 and 28 mc. This unit can be used with either a 50T or RK36. Plug-in coils, wound on manufactured forms, are used for changing bands. Condensers are mounted to bring the shafts out symmetrically on the front panel.

ciency on 14 mc. will result, however, if a 7-mc. crystal is used, the oscillator working as a Tri-tet with its output circuit tuned to 14 mc. so that the amplifier can be excited directly.

For straight amplification without fixed bias, the grid leak should be 15,000 ohms; with 90 volts fixed bias, 5000 ohms. For doubling, the amplifier grid leak should be 30,000 ohms or higher. Adjustment of the compensating condenser,  $C_4$ , is not difficult; set it so that when the tube is properly neutralized, tuning  $C_3$  over a considerable range does not cause more than a small gradual

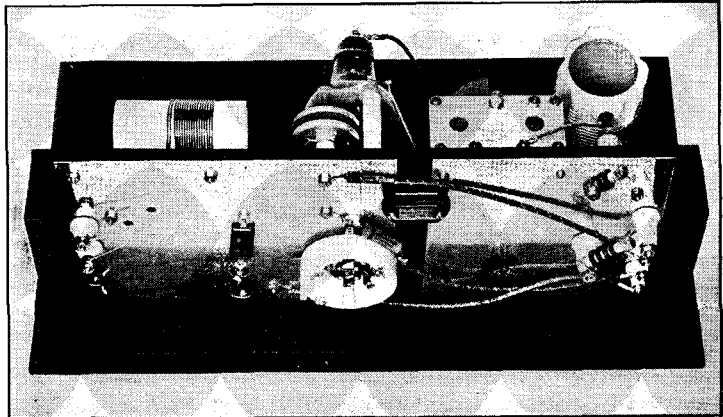

FIG. 939 — A BOTTOM VIEW OF THE SINGLE-TUBE AMPLIFIER

*This photograph shows the two ground plates with the blocking condenser connecting them.*

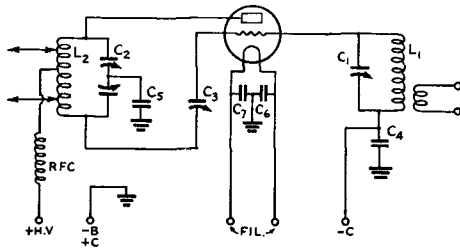

FIG. 938 — CIRCUIT DIAGRAM OF THE SINGLE-TUBE MEDIUM POWER AMPLIFIER

$C_1$  — 50- $\mu$ fd variable, receiving or low-power transmitting type (National TMSA-50).

$C_2$  — Split-stator transmitting type, 100  $\mu$ fd. per section, 3000-volt rating per section (National TMC-100-D).

$C_3$  — Neutralizing condenser (National NC-800).

$C_4$  — .001- $\mu$ fd. mica, receiving type.

$C_5$  — .002- $\mu$ fd. mica, 5000-volt (Sangamo).

$C_6, C_7$  — 0.01- $\mu$ fd. paper, non-inductive (Aerovox).

RFC — Universal-wound short-wave choke (National 100).

$L_1$  — Grid coil (wound on National XR-13 forms):

7 mc.: 15 turns No. 18, diameter 1 $\frac{3}{4}$  inches, length 1 inch.

14 mc.: 9 turns No. 18, diameter 1 $\frac{3}{4}$  inches, length 1 inch.

28 mc.: 4 turns No. 18, diameter 1 $\frac{3}{4}$  inches, length  $\frac{3}{4}$  inch.

$L_2$  — Plate coil (wound on National XR-10-A forms):

7 mc.: 18 turns No. 14, diameter 2 $\frac{1}{4}$  inches, 7 turns per inch.

14 mc.: 12 turns No. 14, diameter 2 $\frac{1}{4}$  inches, 3 $\frac{1}{2}$  turns per inch.

28 mc.: 4 turns No. 14, diameter 2 $\frac{1}{4}$  inches, 3 $\frac{1}{2}$  turns per inch.

Link windings on  $L_1$  consist of two turns, wound close to low-potential ends of grid coils. Coupling should be adjusted by trial to give maximum grid current.

change in amplifier grid current. With  $C_4$  properly set, the amplifier will be permanently neutralized on all bands.

The amplifier may be coupled to the antenna through a pi-section filter of the type described in this chapter, or through a link-coupled antenna-tuning unit, similar to that described in connection with the general-purpose transmitter but with tuning condensers having greater plate spacing.

Power supply data will be found in Chapter Fifteen. The oscillator requires a plate supply delivering 400 volts at 100 ma., the amplifier one delivering 1000 or 1250 volts at 150–175 ma. With a 1250-volt supply, power output in the vicinity of 150 watts can be obtained when the final stage is used as a straight amplifier.

### A Single-Tube High-Frequency Amplifier of Medium Power

● Figs. 937 and 939 illustrate the construction of a single-ended amplifier for 7, 14 and 28 mc., using tubes of low interelectrode capacity such as the RK-36 and 50T. It is suitable for c.w. operation or grid-bias modulation with plate voltages up to 2000, but should not be plate-modulated at more than 1250 volts with the tank condenser illustrated. With a 2000-volt supply, power outputs of 175 watts with the 50T and 220 watts with the RK-36 are readily obtainable at rated plate current when the amplifier is driven by a suitable exciter.

The unit is designed for relay-rack mounting. The panel is 19 by 10 $\frac{1}{2}$  inches and the base 17 by 7 $\frac{1}{2}$  inches. Tuning condensers are mounted on the base, with the shafts projecting through the panel. The placement of parts is readily apparent from inspection of the photographs.

As shown in the underneath view, aluminum plates are used for the ground connections; in this case two of them are used with a high-voltage bypass between them so that a condenser flash-over will not short circuit the plate supply. This precaution is not necessary if the plate voltage is not more than 1500 volts. The plate at the right in the bottom view is connected to the condenser frame; power supply terminals, which come through it, are insulated by the use of ceramic feed-through insulators. The left-hand plate connects to the negative power supply terminal. The tube socket is mounted underneath the base to bring the plate and grid terminals of the tube near the tuned circuits. Input link connections are through feed-through insulators at the left edge.

The circuit is given in Fig. 938. It is a straightforward neutralized triode circuit with link coupling to the grid, and is neutralized and adjusted as described in Chapter Eight. Bias and operating conditions should be as given in the Transmitting Tube Table in Chapter

Five for the type of tube used. An exciter delivering 20 to 25 watts will drive the amplifier to full output and optimum efficiency on any of the bands for which it is designed. Output can be fed to an antenna coupler such as the pi-section unit described in this chapter, or link coupled to an antenna-tuning unit similar to that used with the general-purpose transmitter but with variable condensers of higher voltage rating.

External bias is indicated in the circuit diagram. A grid leak can be used, however, if the amplifier center-tap is keyed.

This unit was described in *QST* for October, 1936.

**A Push-Pull Band-Switching Amplifier for Low-Capacity Tubes**

● An example of breadboard layout for the push-pull amplifier is shown in Figs. 940 and 941. This is such a simple and logical arrangement that it can be used, with minor layout modifications, for practically any of the modern tubes having low interelectrode capaci-

**FIG. 940 — TOP VIEW OF PUSH-PULL AMPLIFIER SHOWING ARRANGEMENT FOR SYMMETRY AND SHORT LEADS**

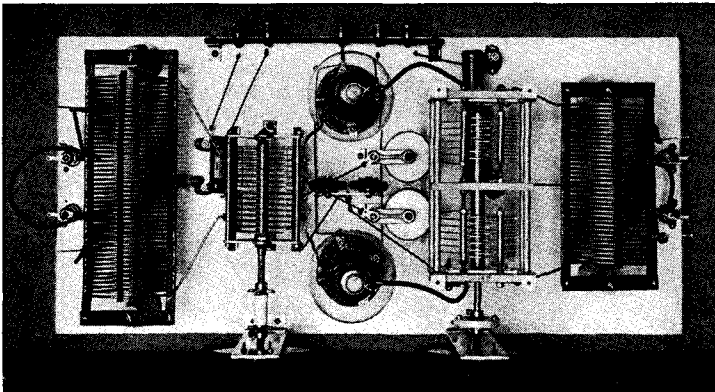
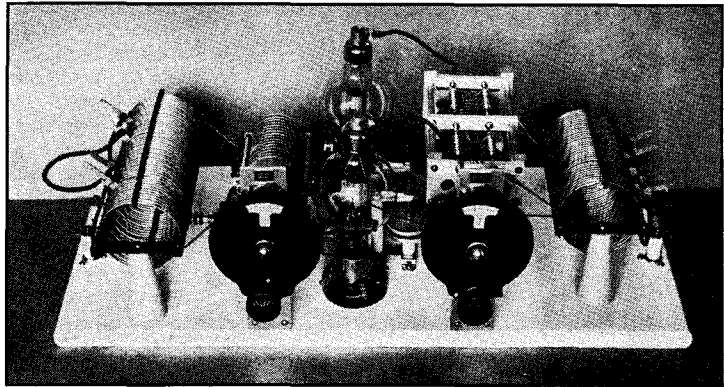

**FIG. 941 — A PUSH-PULL AMPLIFIER FOR HIGH-FREQUENCY**

*Band changing is accomplished by short-circuiting turns in both grid and plate tank coils. Several different types of tubes could be used in this same general layout.*



## Building Transmitters

tances, with no change in the circuit values. The tubes in the photograph are 50T's, but RK18's, RK31's, 35T's, 800's, 834's, 35T's, RK36's or 852's readily could be substituted; the only change necessary would be to allow for the differences in size among these types. With the plate tank condenser specified, this amplifier is suitable for c.w. operation at plate voltages up to a maximum of 1500; for higher-voltage operation, or for plate-modulated 'phone, a tank condenser of the same capacity but with higher voltage rating should be substituted.

The complete circuit of the amplifier is shown in Fig. 942. Provision is made for link coupling to the grids and similar output coupling to an antenna tuning unit. Any of three bands, 3.5, 7 and 14 mc., can be selected by proper placement of the shorting clips on the grid and plate coils; shorting is from the center outward, the taps being kept symmetrical about the center of the coil.

Referring to the photographs, the grid tank circuit is to the left and the plate tank to the right, with the neutralizing condensers and filament bypasses between the two tubes. The grid and plate tuning condensers are mounted above the baseboard on brass strips, the length of the strips being adjusted so that the shafts are on the same level. The plate choke, a solenoid winding on a ceramic core, is on the baseboard underneath the plate tank condenser. The grid leak resistor, *R*, is held above the board by two midget porcelain standoffs, located between the grid coil and its tuning condenser. Power supply connections are brought out to a terminal strip at the rear of the board. The tuning dials, National Type B, are mounted on vertical pieces of aluminum, held to the baseboard by small aluminum angles. Both dials are insulated from the condenser shafts by isolantite couplings.

Adjustment and neutralization should be carried out as described in Chapter Eight for the type of circuit used. The positions of the input and output taps for maximum excitation and maximum output are likely to be found quite critical. If the center-tap of the amplifier is keyed, the bias may be supplied wholly by the grid leak, but it is preferable to have some fixed bias as well. This can be done satisfactorily by connecting a "B" eliminator having an output of 180 to 250 volts across the leak terminals. If the tubes are operated at high plate voltage, extreme caution should be used in making adjustments, since it is possible to run the plate dissipation to dangerous values with a slight misadjustment.

The power output to be expected will depend upon the type of tubes used, the plate voltage and the available driving power. Data on the various tubes is given in Chapter Five; the recommendations in the tube table should

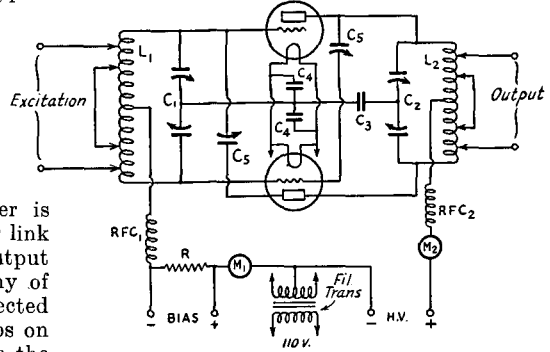

FIG. 942 — CIRCUIT OF THE PUSH-PULL AMPLIFIER

- C*<sub>1</sub> — Cardwell Midway — MT-70-GD — total capacity 35  $\mu$ fds., air gap .070.
- C*<sub>2</sub> — National — TMC-100D — total capacity 50  $\mu$ fds., air gap .077.
- C*<sub>3</sub> — Sangamo .01  $\mu$ fds., 2500 volt.
- C*<sub>4</sub> — Sangamo .01  $\mu$ fds. receiving type.
- C*<sub>5</sub> — National — NC-800 — low capacity neutralizing condenser.
- R* — Ohmite — 5000 ohms, 25 watts.
- L*<sub>1</sub> — 48 turns No. 12 bare wire 3 inches diameter, turns spaced diameter of wire; tapped at  $4\frac{1}{2}$  turns from each end for 14 mc., and  $10\frac{1}{2}$  turns from each end for 7 mc.
- L*<sub>2</sub> — 35 turns No. 12 bare wire 3 inches diameter, turns spaced diameter of wire; tapped at  $3\frac{1}{2}$  turns from each end for 14 mc., and  $13\frac{1}{2}$  turns from each end for 7 mc.
- RFC<sub>1</sub> — National type R-100.
- RFC<sub>2</sub> — Ohmite r.f. choke (large size).

be followed. The layout is readily adaptable to the use of plug-in coils should these be preferred to the shorting system described.

### A Push-Pull Amplifier for 805's, 838's, 203-A's or 211's

● The 203-A and 211 tubes have for many years been among the most popular types with amateurs who wish to get power outputs of 250 watts or more with moderate plate voltages. The comparatively new 838 and 805, of the same general type but with higher ratings and improved performance at the higher frequencies, are likewise rapidly gaining in popularity. A pair of any of these types will give the average amateur as much power as he is likely to need, and because the base connections and general construction of all four are similar, one amplifier design will serve for all with minor modifications.

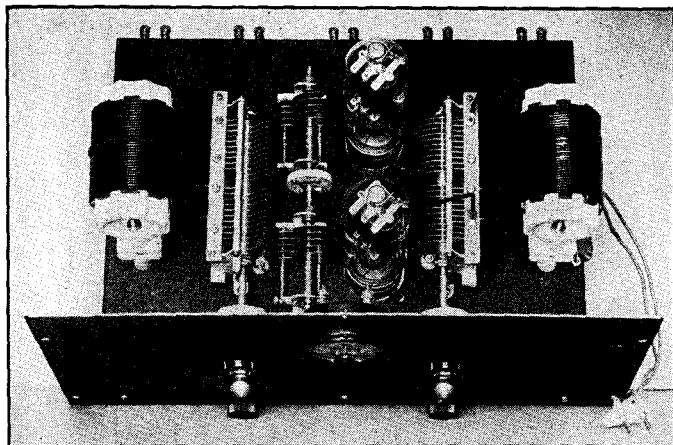

**FIG. 943 — A PUSH-PULL AMPLIFIER FOR 805's, 838's, 203-A's OR 211's**  
*The tubes in the illustration are 805's. The coils are those for 3.5-mc. operation.*

Fig. 943 shows such a push-pull amplifier, arranged for relay rack mounting with a metal chassis and panel. The diagram is given in Fig. 944. The chassis measures  $12\frac{1}{2}$  by  $16\frac{1}{2}$  by  $2\frac{1}{4}$  inches. The plate spacing of the plate tank condenser is sufficient for operation at 1500 volts either for c.w. or plate-modulated 'phone, provided the insulating condenser  $C_6$ , shown in dotted lines in the diagram, is used in the latter case.

In the photograph the layout is as follows: First, the grid coil with its link around it is at the left. The GR plug-and-base used provides outlets for seven connections, of which five are needed. The grid tuning condenser,  $C_2$ , is next, mounted by brackets direct to the chassis. The neutralizing condensers,  $C_3$  and  $C_4$ , are insulated from the chassis by mounting on porcelain feed-throughs. A high-voltage shaft coupling connects the condensers for single control. Next come the 50-watt sockets, sub-base mounted so that only the metal shells (which are grounded) appear above the top of the chassis. The plate tuning condenser,  $C_1$ , and tank coil complete the layout above the chassis. Four ceramic bushings are used to carry the grid and plate r.f. connections under the chassis to the socket terminals. The criss-cross wiring of the neutralizing condensers is done above the chassis. In the unit shown, the plate tuning condenser is mounted on brackets directly

to the chassis, which grounds the rotor of the condenser. If 'phone work is contemplated it is suggested that the condenser be insulated from the base by mounting the brackets on insulating feed-throughs and grounding through an r.f. by-pass as previously mentioned.

The only components underneath the chassis are plate and grid chokes, grid resistor and filament by-pass condensers. The terminals at the rear are GR pairs Type 274-Y. From left to right these are as follows: Input link circuit; grid circuit for zero or external bias; grid circuit for resistor or resistor-battery bias; fila-

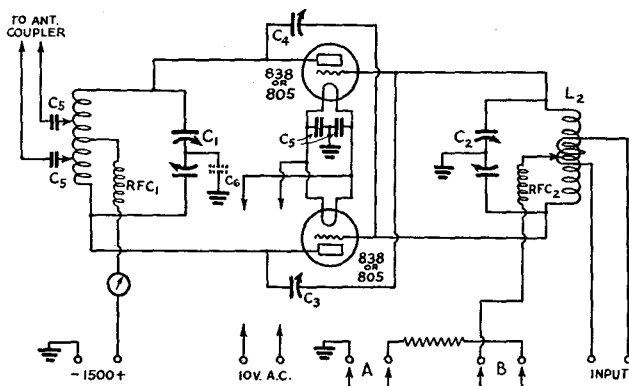

**FIG. 944 — CIRCUIT OF THE PUSH-PULL AMPLIFIER SHOWN IN FIG. 942**

- $C_1, C_2$  — 100  $\mu\text{fd.}$  in each section, 0.07" air gap (Cardwell MD-100-GD).
- $C_3, C_4$  — Variable neutralizing condensers ganged. (Bud type 566 with 3 rotor and 3 stator plates removed).
- $C_5$  (Output coupling) — 1500-volt, 0.01- $\mu\text{fd.}$  by-pass.
- $C_5$  (Fil. by-pass) — 0.002- $\mu\text{fd.}$  by-pass.
- $C_6$  — 1500-volt, 0.01 by-pass. See text.
- RFC<sub>1</sub> — Receiving type layer-wound choke.
- RFC<sub>2</sub> — Ohmite Type Z-4.
- $L_1$  — Plate coils, wound on C.R. Type 677-U plug-in ceramic forms, diameter  $2\frac{7}{8}$  inches,  $4\frac{1}{2}$  turns per inch. The 7 and 14 mc. coils have 14 and 6 turns, respectively. For 3.5 mc., the diameter is increased by filling out the forms with spacers of  $\frac{1}{4}$ -inch bakelite; the winding consists of 36 turns of No. 12 enamelled wire. No. 12 bare wire is used for the 7 and 14 mc. coils.
- $L_2$  — Grid coils, wound on same type forms as  $L_1$ . For 3.5 mc.: 36 turns as described above for  $L_1$ ; for 7 mc., 18 turns; for 14 mc., 7 turns; all wound with No. 12 wire.

# Building Transmitters

ment, and finally, plate supply connections. The two pairs of connections in the grid circuit are shown in the circuit diagram. This arrangement gives a variety of biasing combinations, depending on the tubes to be used and the type of operation ('phone or c.w.).

The flexible plate leads with clips to fit the top caps of the 805's shown in the photograph will not be necessary with tubes having all element connections brought out through the base. Plate connections for the latter type of

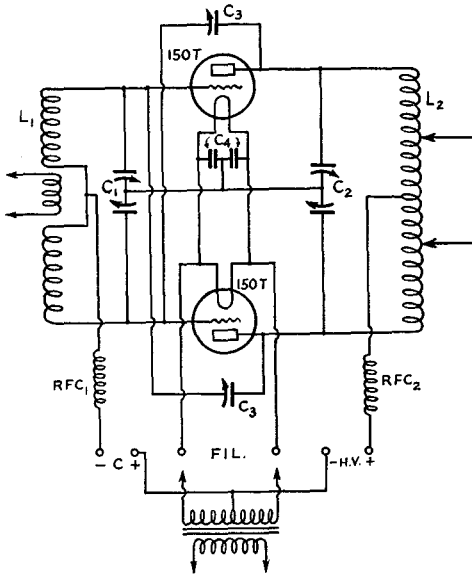

FIG. 945 — CIRCUIT DIAGRAM OF THE HIGH-POWER 150T AMPLIFIER

C<sub>1</sub> — 100 μfd. per section airgap .077" (National TMC-100D).

C<sub>2</sub> — 60 μfd. per section airgap .469" (National TML-60DD).

C<sub>3</sub> — High voltage, low capacity neutralizing condenser-National NC-150.

C<sub>4</sub> — .01-μfd. mica, receiving type (Sangamo).

RFC<sub>1</sub> — National R-100.

RFC<sub>2</sub> — National R-154.

L<sub>1</sub> — Split grid winding:

7 mc. — 10 turns each half, 2¼ inches diameter, 7 turns per inch, ¾ inch between halves.

14 mc. — 6 turns each half, 2¼ inches diameter, 7 turns per inch, ¾ inch between halves.

28 mc. — 3 turns each half, 2¼ inches diameter, 3.5 turns per inch, ½ inch between halves.

L<sub>2</sub> — Plate circuit coils:

7 mc. — 20 turns ¼ inch copper tubing, 4 inches diameter, 7½ inches long.

14 mc. — 14 turns ¼ inch copper tubing, 2¾ inches diameter, 7½ inches long.

28 mc. — 6 turns ¼ inch copper tubing, 2½ inches diameter, 4 inches long.

Number of turns in grid link winding will depend upon preceding circuit. Usually one turn at 28 mc., 2 turns at 14 mc. and 3 turns at 7 mc. will be sufficient.

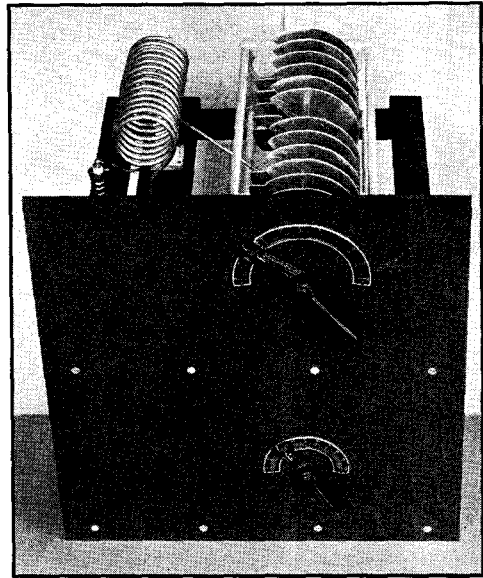

FIG. 946 — A HIGH-POWER HIGH-FREQUENCY PUSH-PULL AMPLIFIER

Using a pair of 150T's, this amplifier will easily handle an input of one kilowatt on the 7, 14 and 28 mc. bands. The layout is readily adaptable to a pair of 354's as well.

tube should be run through feed-through insulators to the appropriate socket terminals.

The amplifier is tuned and neutralized in the same way as other push-pull amplifiers, the procedure being described in Chapter Eight. Currents and voltages should be according to the ratings given for the particular type of tube used in Chapter Five. The amplifier can be driven satisfactorily for either c.w. or 'phone by any of the exciters or transmitters shown in this chapter giving an output of approximately 50 watts.

## A High-Power Push-Pull Amplifier

● The neutralized push-pull amplifier shown in Figs. 946 and 947, using a pair of 150T tubes, will satisfy the requirements of those amateurs who want to use the maximum power of one kilowatt input permitted under the amateur regulations. Designed primarily for high-frequency operation — 7, 14 and 28 mc. — it can be used either for c.w. or plate-modulated 'phone, working well within the ratings of the tubes and components used on both. It has been made as compact as possible so that it can be relay rack mounted.

The two photographs show practically all the layout details. The panel measures 19 by

21 inches. The base on which the input circuit and tube sockets are mounted is 15 by 15 inches. At the top, the wooden frame, made from dressed 1 by 2 stock, extends 18½ inches back of the panel to accommodate the plate

The plate coils are wound with copper tubing, are self-supporting, and are mounted on heavy-duty plugs which fit into the large jack insulators. Coils for the grid circuit are wound on ceramic forms, each coil being in two sections with the link winding between. Since five connections are needed, the forms are mounted on strips of victron in which five G.R. type plugs have been mounted, to plug into five jack-top standoffs mounted on the base.

Details of neutralizing and tuning this type of amplifier are covered in Chapter Eight. Any of the various forms of antenna coupling can be used with it, providing parts of suitable voltage rating are used in the coupler. The link-coupled antenna tuner lends itself well to operation with an amplifier of this power. An output of about 750 watts can be obtained without difficulty if the amplifier is driven by an exciter capable of delivering about 75 or 100 watts to the grids. For plate-modulated 'phone, an exciter output of about 150 watts is advisable to insure a linear modulation characteristic. The full kilowatt input may be secured by the use of a 2500-volt plate supply capable of delivering 400 ma. Higher voltage at lower current may be used if desired. With normal efficiency, the tubes work well within their plate-dissipation ratings.

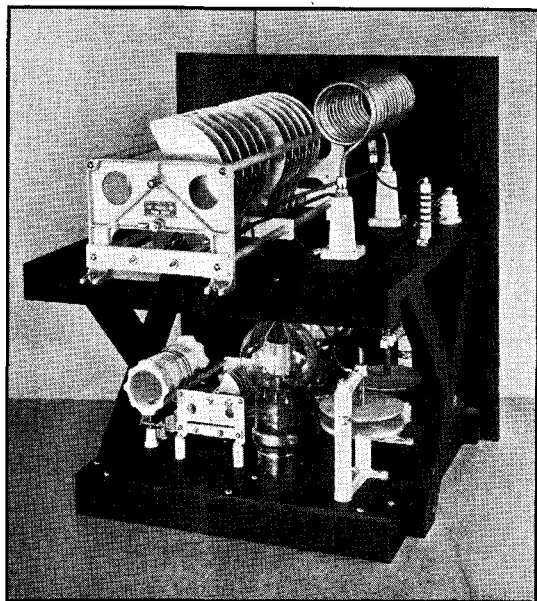

FIG. 947 — A REAR VIEW OF THE HIGH-POWER PUSH-PULL AMPLIFIER

*This view shows the arrangement of the tubes and circuit elements. Filament bypass condensers and power wiring are underneath the base.*

tank condenser. The structure is sufficiently rigid mechanically so that the whole unit can easily be supported by the panel when fastened to the rack.

The circuit diagram, shown in Fig. 945, is the standard push-pull circuit, with link coupling to the grid coil. The grid and plate coils are separated as far as possible to reduce coupling between them. The tube sockets project through the base, thus concealing the filament wiring, and lowering the tubes themselves so that they can be removed from the sockets without difficulty from their position below the tank condenser platform. The neutralizing condensers are mounted alongside the tubes as shown in the back view.

When operating at high plate voltage it is advisable to use fixed bias on the tubes to prevent damage to them should excitation be cut off accidentally. A bias power pack with a heavy bleeder, made as described in Chapter Fifteen, will be suitable. If leak bias is used, the leak should have a resistance of about 5000 ohms.

Preliminary tuning of the amplifier should be done at low plate voltage — about 1000 volts — to prevent damage to the tube filaments during the periods when the plate tuning is off resonance. When the amplifier is coupled to the antenna and delivering some power, the plate voltage may be raised and the coupling adjusted to make the tubes draw normal plate current. With a 5000-ohm leak or with a bias supply giving 400 to 500 volts, the grid current should be between 75 and 100 milliamperes.

# 10

## Keying Methods

### AND ELIMINATION OF INTERFERENCE WITH BROADCAST RECEPTION

**T**HE output of a continuous-wave transmitter cannot be utilized for the communication of intelligence until a means is provided for breaking it up into the dots and dashes corresponding to the characters of the International Morse Code. This rapid turning on and off of power is the most elementary form of modulation. While keying may at first thought seem so essentially simple that detailed treatment is hardly required, there are many considerations which make it a very important subject indeed. These concern not only the simple act of forming dots and dashes, but the possible undesired effects that may result from so breaking up the transmitter's output.

Satisfactory keying, from the standpoint of code-character formation, results if the keying

method employed reduces the power output to zero when the key is "open" and permits full power to reach the antenna when the key is "closed." Several obvious methods of doing this will occur to the reader; the key could be connected in series with the primary of the plate power transformer, in series with one of the d.c. plate supply leads to the tube itself, and so on. While any number of methods will fulfill the primary purpose of turning the power on and off, all have their inherent advantages and disadvantages. Certain methods also will appeal to one individual more than to others. We shall discuss a number of different keying systems in this chapter so that the amateur can weigh their merits according to his own particular set of conditions and make his choice accordingly. The selection of a keying system is distinctly an individual proposition; almost any keying method can be applied to almost any transmitter.

#### Fundamental Keying Methods

● Methods by which the output of a vacuum tube can be controlled may be divided into two groups. These are, respectively, direct control of the plate input by turning the plate power on and off; and control of the excitation supplied to the tube's grid circuit. A combination of the two also may be used. With multi-element tubes such as tetrodes and pentodes, the same result may be achieved by proper application of keying methods to the additional elements in the tube.

Three varieties of plate-keying methods are shown in Fig. 1001. In the first, the key is connected in series with the primary of the plate power transformer. The second diagram shows the key connected in the center-tap lead from the secondary of the plate transformer, making and breaking the circuit between the transformer and rectifier-filter input. The lower drawing shows the key placed in the negative lead from the plate supply to the tube; it could be placed in the positive lead if

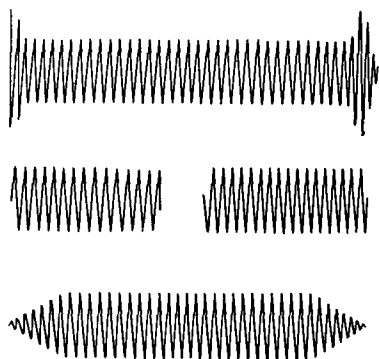

HOW DIFFERENT TYPES OF KEYED SIGNALS LOOK

*The upper drawing shows a signal with pronounced keying transients at the beginning and end of a character. Such a signal would cause considerable interference locally and at a distance as well. The middle drawing is the ideal type — no variation in amplitude at the start or ending of a character, no keying transients. The lower drawing shows the effect of using lag circuits for eliminating key clicks; the signal builds up gradually and stops gradually.*

*These drawings are copies of oscillographic records taken on actual signals.*

desired, but since the latter connection places the key at the plate potential it is seldom used except when a keying relay is available.

The operation of these keying methods is easily understood, since the key alternately connects and disconnects the source of plate power.

**Grid Keying**

● Grid keying methods operate on the principle of controlling plate current flow through application of proper bias values with the key opened and closed. Three representative arrangements are shown in Fig. 1002. The upper drawing shows the key inserted in series with the grid leak or grid return circuit. With the key closed, the amplifier or oscillator operates normally; with the key open, there is no d.c. path between grid and filament, consequently the electrons drawn to the grid by the exciting voltage remain trapped on the grid causing it to assume a highly negative charge. If there is no leakage in the grid-filament circuit the negative charge will be sufficient to cut off completely the flow of plate current and therefore the power output.

Another method of accomplishing the same result, in this case through supplying additional fixed bias of sufficient value to cut off plate current flow despite excitation, is shown in the middle drawing of Fig. 1002. Grid-leak bias for normal operation is shown, although a battery or other bias source could be substituted for the leak. With the key closed, the lower end of the leak is connected to the filament center tap. When the key is opened, additional bias from the battery is connected

in series with the leak through the resistor *R*. The chief function of *R* is to limit the flow of current from the battery when the key is closed, since without *R* the key would be a direct short circuit for the battery. The value of *R* is not critical but should be quite high — at least 5000 ohms for every 45 volts of battery — to limit the current to a safe value. A "C" power pack can be substituted for the battery if desired. The additional bias voltage required to cut off plate current (or "block" the grid) will depend upon the amplification factor of the tube and the amplitude of the excitation voltage; it must at least be equal to the peak positive grid swing plus the bias required to cut off plate current without excitation. Since it is difficult to measure or calculate the grid swing, the operating value of keying bias had best be determined experimentally. If the amplifier or oscillator is operating Class-C, the keying bias required probably will be two or three times the normal operating bias (twice cut-off). For example, if the Class-C operating bias is 200 volts the total bias required to block the grid probably will be 400 or 500 volts. Smaller bias would serve for an amplifier with less excitation.

The lower drawing of Fig. 1002 shows a method of blocked-grid keying in which the keying or blocking bias is obtained from the plate supply, thus eliminating the need for a separate bias source. Resistors *R*<sub>1</sub> and *R*<sub>2</sub> are in series across the output of the power supply, *R*<sub>1</sub> being the regular power supply bleeder. The filament center-tap is connected to the junction of *R*<sub>1</sub> and *R*<sub>2</sub> and the grid return to the negative terminal of the power supply, the key being connected across *R*<sub>2</sub>. With the key open, the voltage drop across *R*<sub>2</sub> is applied to the grid of the tube as blocking bias; when the key is closed, however, the negative power supply terminal is connected directly to filament center-tap, thus leaving only the regular operating bias — in this case supplied by the flow of grid current through the grid leak — in the circuit. As before, a battery or other bias source may be substituted for the leak. The blocking bias may be made as great as desired by choosing a suitable value of *R*<sub>2</sub> with respect to *R*<sub>1</sub>. For most oscillators or amplifiers, sufficient keying bias will be obtained when the resistance of *R*<sub>2</sub> is one-third to one-half that of *R*<sub>1</sub>.

**Center-Tap Keying**

● A combination of both grid and plate circuit keying is shown in Fig. 1003. This method, known as center-tap keying, has attained wide popularity, although recently the grid-blocking

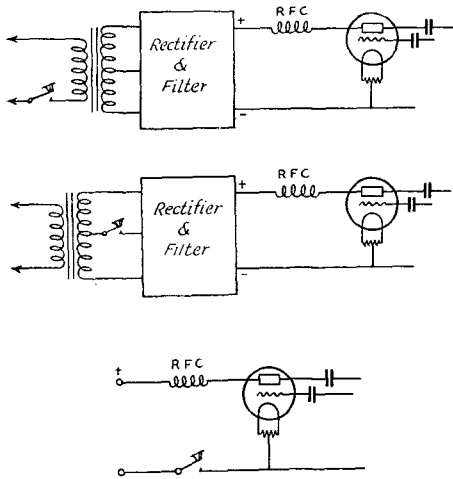

FIG. 1001 — PLATE-KEYING METHODS

# Keying Methods

methods have been gaining in favor. In center-tap keying, one side of the key is connected to the midpoint of the filament center-tap resistor or to the center-tap of the filament transformer; the grid and plate returns connect

or pentode type, the screen potential has a very marked effect on the plate current, and therefore the output of the tube. Screen-grid tubes often can be keyed by inserting the key in the positive screen lead, especially when the screen voltage is obtained from a supply separate from that furnishing the plate power. If the screen voltage is obtained from the plate supply through a dropping resistor, this method of keying is unsafe with high-voltage tubes unless a keying relay is used, because the potential on one side of the key rises to the full plate potential when the screen current is cut off. Opening the screen circuit does not always reduce the output to zero, however, so screen keying is seldom used.

If the keyed tube is a pentode, the suppressor-grid offers a means of satisfactory keying. Maximum output with pentode tubes ordinarily is secured when the suppressor grid is biased positive a small amount — 50 to 100 volts. Merely inserting the key in the suppressor lead is not sufficient to cut off the power output, so it is necessary to arrange the keying circuit to put negative bias on the suppressor when the key is open. This can be done much in the same way as in the grid-keying methods already described. Fig. 1004 illustrates one method, using a separate power pack which supplies operating bias for the control grid and keying bias for the suppressor grid. With the key open, the suppressor receives negative bias through the 50,000-ohm resistor, the value of bias being adjusted to cut off plate current. When the key is closed, the suppressor bias is made positive through connection to a suitable tap on the plate-supply bleeder. The 50,000-ohm resistor prevents short-circuiting the bias supply, performing the same function as resistor  $R$  in Fig. 1002. The combination of  $R_1$  and  $C_1$  forms a lag circuit for the elimination of clicks. The amount of lag may be varied to suit requirements by adjusting either or both of these values. The values suggested seem to be about right for average cases. A bias supply delivering 200 volts or more will be

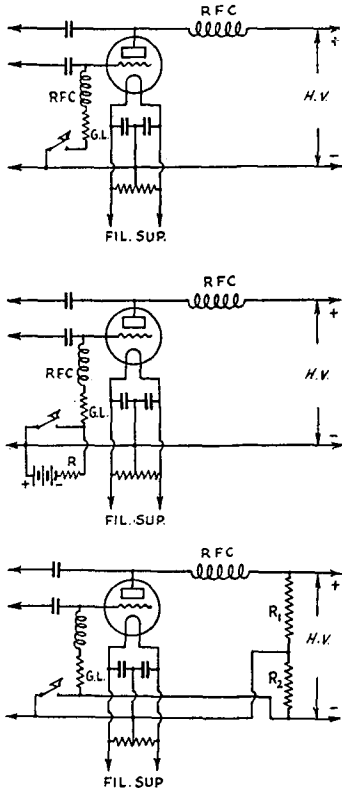

**FIG. 1002 — THREE METHODS OF BLOCKED-GRID KEYING**

*In all these diagrams a center-tapped filament transformer can be substituted for the center-tapped resistor shown.*

to the other side of the key. In this way both grid and plate returns are opened when the key is open.

Center-tap keying combines some of the good and bad features of both grid and plate keying.

### Keying Multi-Element Tubes

● All of the foregoing keying methods can be used with tetrode and pentode type transmitting tubes, since they operate on d.c. circuits common to all types of tubes. With multi-element tubes, however, additional keying circuits are possible.

In screen-grid tubes, whether of the tetrode

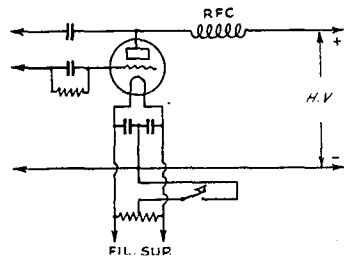

**FIG. 1003 — CENTER-TAP KEYING**

sufficient for keying any of the pentode transmitting tubes now available.

Another method of suppressor keying is shown in Fig. 1005. In this case no additional bias source is needed, the keying bias for the

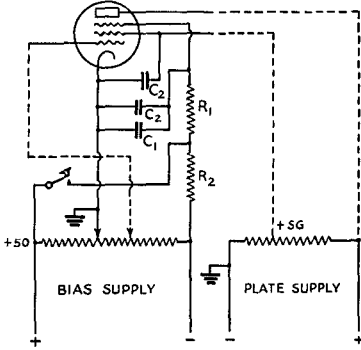

**FIG. 1004 — SUPPRESSOR KEYING OF A PENTODE TRANSMITTING TUBE**

The keying system is arranged to put positive bias on the suppressor grid with the key open, and negative bias with the key closed.

suppressor being obtained from the voltage drop caused by the flow of rectified grid current through the grid leak. The leak therefore replaces the separate bias supply. For this method to be successful, it is essential that the drop across the leak be large enough to cut off plate current when applied to the suppressor. This usually calls for a fairly high-resistance leak (about 15,000 ohms) and a grid current of 5 to 10 milliamperes, depending upon the type of tube used.

**Sources of Bias for Grid Keying**

● In many respects grid-blocking systems (including screen- and suppressor-grid as well as control-grid systems) are to be preferred to other types of keying. The chief objection to their use is the cost of the keying bias supply. In the lower diagram of Fig. 1002 this objection is overcome through obtaining keying bias from the plate supply; the suppressor keying

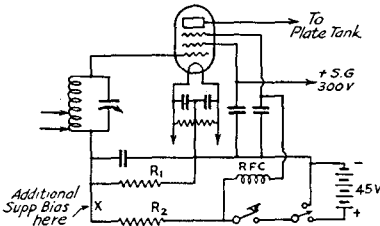

**FIG. 1005 — A SUPPRESSOR KEYING SYSTEM IN WHICH KEYING BIAS IS OBTAINED FROM THE GRID LEAK**

method of Fig. 1005 likewise is an economical one. It is also possible to obtain keying bias without extra cost from the power supply used for low-power stages in multi-stage transmitters, when the keyed stage has its own separate supply. The way in which this can be done is illustrated in Fig. 1006. The plate power supply for the exciter tubes is utilized as a keying bias supply for the keyed amplifier. Since this entails connecting the positive terminal of the low-voltage supply to the nega-

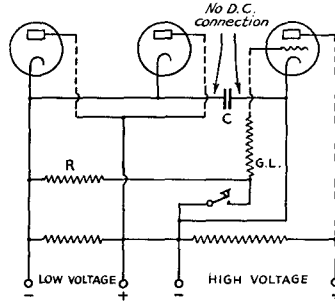

**FIG. 1006 — UTILIZING THE LOW VOLTAGE POWER SUPPLY FOR BLOCKING BIAS IN BLOCKED-GRID KEYING**

tive terminal of the high-voltage supply, the filament circuits of the tubes working from the two supplies cannot be connected together. In Fig. 1006, the condenser *C* serves to put all cathodes at the same r.f. potential without direct connection between them. Resistor *R* limits the current when the key is closed, as already explained. A value of 50,000 ohms will suffice for a low-voltage supply of 400 volts or so. It should have a rating of about five watts.

**General Considerations in Keying**

● A good keying system should fulfill three requirements — it should prevent completely the radiation of energy from the antenna when the key is open and should give full power output when the key is closed; it should do this without causing keying transients, or "clicks," which cause interference with other amateur stations and with local broadcast reception; and it should not affect the stability of the transmitter.

From various causes some energy may get through to the antenna during keying spaces. The effect then is as though the dots and dashes were simply louder portions of a continuous carrier; in some cases, in fact, the "back-wave," or signal heard during the keying spaces, may seem to be almost as loud as the keyed signal. Under these conditions the keying is hard to read. A pronounced back-wave



often results when the amplifier stage feeding the antenna is keyed; it may be present because of incomplete neutralization of the final stage, allowing some energy to get to the antenna through the grid-plate capacity of the tube, or because of magnetic pickup between antenna coupling coils and one of the low-power stages. In such cases it can be remedied by proper neutralization or by rearranging the tank circuits to eliminate unwanted coupling. Shielding also will help.

A back-wave also may be radiated if the keying system does not reduce the input to the keyed stage to zero during keying spaces. This trouble will not occur in keying systems which cut off the plate voltage when the key is open, but may be present in grid-blocking systems if the blocking voltage is not great enough. If the plate current does not go to zero when the key is open, more blocking voltage is required. In the upper circuit of Fig. 1002, the tube will not be completely blocked if there is any leakage between grid and cathode of the tube. This leakage may take place in the tube itself or its base, in the socket, through poor insulating material on which any of the parts may be mounted, in the key, or in the leads running to the key. If the leakage resistance is even as high as a few megohms a small plate current may flow, producing an evident back-wave.

### Choosing the Stage to Key

● Radiation of a back-wave often can be prevented by keying a buffer stage preceding the final amplifier. Naturally in such a case

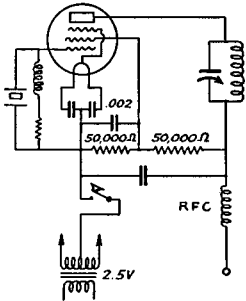

**FIG. 1007 — PENTODE CRYSTAL OSCILLATOR KEYING TO ELIMINATE CHIRPS**

*Essential to the system is the use of a voltage divider instead of series resistor for obtaining screen voltage. A center-tapped resistor may be connected across the filament leads if the filament transformer has no center-tap.*

there will be less likelihood that energy will get through to the antenna, since it would have to go through two stages instead of one.

Keying the oscillator also will prevent radiation of a back-wave.

If one of the early stages in the transmitter is keyed, the following stages must be provided with fixed bias sufficient to cut off plate current, or at least to limit the current to a safe value. Complete cut-off is preferable, since the possibility of back-wave radiation is reduced when no plate current at all is drawn by the tubes following the keyed stage. If sufficient bias for cut-off is not available, the plate current should be reduced to a value such that the d.c. input does not exceed the rated plate dissipation of the tube. Cathode bias, explained in the chapter on transmitter design, may be used for this purpose.

The stability of the transmitter can be adversely affected by keying if the keyed stage follows the oscillator. Practically all oscillators, including crystal-controlled types, will exhibit some frequency change with changes in load. In a multi-stage transmitter the load on the oscillator is of course the input circuit of the following tube; since the resistance represented by this load changes when the tube is keyed, there will be a corresponding change in oscillator frequency. So long as the frequency is stable with the key closed, this will not do particular harm, although if a back-wave is radiated the back-wave will give a beat note differing slightly from that of the keyed signal. However, if a lag circuit — to be described later — is used with the keying system the change in frequency will be gradual instead of instantaneous, giving rise to a chirpy or “yooping” signal, which is highly undesirable. For this reason it is good practice to have a buffer stage between the oscillator and the keyed stage. Electron-coupled or Tri-tet oscillators are less subject to this difficulty than straight self-controlled or crystal oscillators because of the buffering action of the separate output circuit used in these oscillators.

When the oscillator itself is keyed there is no variation in load, although the keying may be chirpy for other reasons. In general, an oscillator will tend to chirp under keying if the loading is too great or, if a crystal oscillator, with the plate condenser set too near the point where oscillation stops. In pentode crystal oscillators, chirps also may result if the screen voltage varies when the key is opened and closed, as may be the case if the screen voltage is obtained through a dropping resistor from the plate supply. Separate screen supply, or supply from a voltage divider across the plate supply, often will prevent chirps in such a case. A “chirpless” circuit using center-tap keying of the crystal oscillator is shown in Fig. 1007.

## Keying Transients or Clicks

● When power is applied or removed from a circuit very suddenly, as is the case when a transmitter is keyed, the energy thus instantaneously released surges back and forth in the circuit until equilibrium is reached. This is called "shock excitation." A familiar mechanical analogy is the vibration of a tuning fork or a bell when tapped with a small hammer or mallet. Shock-excited oscillations are highly damped in most circuits and therefore have no sharply-defined natural period. In other words, such an electric oscillation, if radiated, can be detected in receivers tuned to frequencies widely different from that on which the actual transmitting is being done. Since the duration of the oscillation is short, it is heard as a "click" or "thump" in the affected receiver. The click on closing the key usually is much more pronounced than on opening, although under certain conditions the reverse may be true.

Because the amount of energy involved is small and is distributed over a wide band of frequencies, the interference-producing effects of keying transients usually are confined to an area quite close to the transmitter except on frequencies within a few kilocycles of the transmitting frequency. In other words, key clicks are likely to be observed on only those broadcast receivers located within a hundred yards or so of the transmitter, but may cause interference to amateur stations hundreds of miles away working in the same portion of the same band.

Obviously it is to the interests of the amateur himself to prevent key clicks, not only because of a possible unfavorable reaction on the part of nearby broadcast listeners but also to prevent unnecessary interference in the amateur bands.

## Prevention of Key Clicks

● There are two general methods of attack in preventing keying transients. The first is by feeding the power to the transmitter at a comparatively slow rate on closing the key and shutting it off gradually instead of suddenly on opening the key. The second is by the use of radio-frequency filters which absorb the transient before it can get to a part of the circuit from which radiation is possible. Both methods have been very successful.

In the first method, an inductance of a few henrys is inserted in the circuit, usually in series with the key. As explained in Chapter Three, an inductance coil possesses the property of opposing a sudden change of current in a circuit. Regardless of the method of keying used, insertion of inductancy in series with the

key will have the effect of causing the plate current to build up to its final value at a comparatively slow rate, since some current, no matter how small, always flows in the key circuit.

The energy stored in the electromagnetic field of the inductance when the key is closed is suddenly returned to the circuit when the key is opened. If the current in the circuit is appreciable, the inductive discharge will cause an arc or spark to form at the key contacts at the moment of opening. The spark not only causes undue wear on the contacts but also is a secondary cause of key clicks, since the key circuit acts somewhat like a miniature spark transmitter. An effective remedy for this condition is to shunt a condenser (usually from 0.25 to 1  $\mu$ fd.) across the key to absorb the spark. The energy stored in the inductance is released through the condenser instead of at the key contacts and thus tends to prevent the sudden cessation of power on opening the key.

In most keying circuits there is an appreciable voltage across the key contacts when open, hence the condenser in the key-click filter will receive a charge. On closing the key the charge is dissipated in the key contacts, again causing a spark, unless a resistor of suitable value is put in series with condenser and key to absorb most of the energy. The value of the resistor will depend, as is apparent from the foregoing discussion, upon the capacity of the condenser and the voltage appearing across it when the key is open. Because of the variable nature of these factors it is difficult to give definite specifications. However, a resistor of from 50 to a few hundred ohms usually will be found to absorb the spark satisfactorily.

A complete key-click filter of this type — often called a "lag" circuit because of the delay or lag in application of power to the transmitter — is shown in Fig. 1008. In general, all values,  $L$ ,  $C$  and  $R$ , must be determined experimentally for the particular transmitter and local conditions. Identical values may not

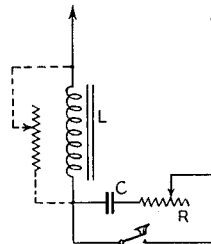
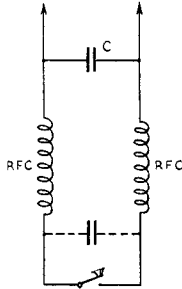

FIG. 1008 — A TYPICAL LAG CIRCUIT FOR ELIMINATING KEY CLICKS OR THUMPS

The primary of a bell-ringing transformer often will serve at  $L$  in low-power transmitters. See text for discussion of values.

give the same performance with different transmitters or at different locations where wiring conditions, location of receivers, etc., are seldom duplicated. They usually will be found to lie in the ranges already mentioned, however. A variable resistor, shown connected by dotted lines in Fig. 1008, can be used to vary the effect of the inductance. A variable



**FIG. 1009 — AN R.F. FILTER FOR THE ABSORPTION OF KEYING TRANSIENTS**

*It is ordinarily used without a condenser directly across the key. However, an improvement sometimes results when a condenser of about .002  $\mu$ fd. is connected as shown by the dotted lines.*

resistor also is useful as the spark absorber, permitting quick adjustment to the most desirable operating value.

The values of  $L$  and  $C$  should be the smallest that will give satisfactory key-click elimination. If the inductance and capacity are too great, the slowing-up will be so pronounced that the dots and dashes will not be cleanly defined. This will make the signals hard to read.

**FIG. 1010 — A VACUUM-TUBE KEYING METHOD TO PREVENT CLICKS**

*One or more keyer tubes may be used; the larger the number the greater the plate current that can be safely passed. Condenser  $C$  may be between .25 and 1.0  $\mu$ fd. Resistor  $R$  should be adjusted to cause the plate current to drop to zero when the key is open. A variable resistor of about 50,000 ohms should give enough range.*

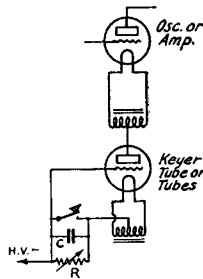

### Keyer Tubes

● A vacuum-tube lag-circuit keying arrangement which has attained considerable popularity is shown in Fig. 1010.

In this system a vacuum tube is placed with its plate-filament circuit in the center-tap of the tube to be keyed, while the key itself is in the grid circuit of the auxiliary or "keyer"

tube. When the key is open, high negative bias is placed on the grid of the keyer tube so that the plate current is completely cut off; when the key is closed the grid of the keyer tube is connected to its filament and the tube acts like a resistance of low value, thus permitting plate current to flow to the oscillator or amplifier being keyed. The time-constant of the inductance and capacity in the grid circuit of the keyer tube provides the slow build-up of power output which prevents clicks. Since the key is in a low-voltage low-current circuit, the transients set up in the key circuit itself are of small intensity. The keyer tube has some resistance even though the grid is connected to the filament, so the plate voltage on the oscillator or amplifier will be lower than with other keying systems. To overcome this several tubes may be connected in parallel. Tubes of the 45 type are excellent for low-power transmitters because their plate resistance is low. One 45 should be used for each 50 ma. of plate current required by the tube being keyed. The filament transformer for the keyer tubes need not be center-tapped; in fact, the filaments may be connected in series if desired.

### Parasitics and Key Clicks

● If it is found that the use of standard key click filters has little or no effect upon clicks, an investigation should be made to determine if parasitic oscillations are taking place in any of the transmitter circuits. In any case, it should be possible to adjust the bias of any amplifier so that some plate current is drawn without the amplifier going into oscillation. If oscillations do take place, steps should be taken to prevent it because the chances are good that self-oscillations may have a tendency to start each time the key is closed resulting in bad key clicks even though the oscillation is immediately killed off by excitation.

### R.F. Filters

● With an r.f. key filter the transient oscillations set up at the key are prevented from reaching the transmitter and being radiated. To be most effective, this type of filter must be installed right at the key, since connecting leads of even a few feet between key and filter are long enough to permit radiation of clicks and consequent interference to nearby receivers. In fact, the same thing is true of the lag circuits previously described — even though they perform their intended function of preventing the sudden application and cessation of power, transients in the keying circuit itself may be radiated to cause interference. Short leads usually will prevent such a condition.

although in some cases it may be necessary to install an r.f. key filter as well.

An r.f. key filter usually consists of a pair of r.f. choke coils having an inductance of ten millihenrys or so, connected in series with each of the key contacts and shunted by a condenser as shown in Fig. 1009. The condenser ordinarily will have a capacity of 0.1 to 0.5  $\mu$ fd. The combination acts like a low-pass filter, preventing transients at broadcast or higher frequencies from getting to the transmitter itself and being radiated. As with the lag circuit, some experimenting with different inductance and capacity values probably will be required for effective elimination of clicks in individual transmitters.

### Other Considerations in Key Click Prevention

● It is reasonable to expect that less trouble will be encountered in eliminating key clicks if the power supply for the keyed stages has good voltage regulation (see Chapter Fifteen). If the voltage regulation is poor, the plate voltage with the key open may be 50% to 100% higher than with the key closed; hence, at the instant of closing the key there is an impact at much higher than normal voltage. This intensifies the key click. If the power supply regulation is good — that is, if the plate voltage is substantially the same whether zero or full plate current is being drawn — the tendency towards clicks is lessened.

Key clicks are less likely to be radiated if the antenna or feeder system is inductively coupled to the transmitter rather than directly or capacitively coupled. If the feeders are tapped on the final tank coil or are inductively or capacitively coupled through a low-pass filter, comparatively little impedance is offered to transients covering the broadcast band. A considerable improvement in key click reduction often can be secured simply by changing a non-inductively coupled system to one in which the transmitted energy must be air-transferred at some point before reaching the antenna. Care should be taken to prevent stray capacitive coupling.

Not all key-click interference with broadcast reception is radiated from the antenna. It may be radiated from the transmitter itself or from connecting wires. Shielding of transmitter and wiring often will result in a considerable improvement in this respect, although it is not always necessary.

It is always desirable and in some cases may be necessary to run the 110-volt leads to the transmitter in BX cable, grounding the outer shield. Shielding of the keying leads also may

be helpful, especially if a long line is run between the transmitter and the key. Whenever shielded wire is used the shield should be connected to a good ground, otherwise the shielding is likely to be ineffective.

To prevent keying transients from being carried over house wiring and power lines from the transmitter to nearby receivers, a filter may be installed in the 110-volt line which feeds the power transformers. Such a filter is shown in Fig. 1011. It consists of a pair of radio-frequency choke coils, one in each leg of the line, and a pair of condensers in series across the line with their mid-connection grounded.

The wire of which the chokes are wound must be heavy enough to carry the current taken by the power-supply system. No. 14 or No. 16 will be sufficient in most cases. Mailing tubes make good winding forms for these chokes. Between 100 and 300 turns will be required. The condensers may be 0.1- $\mu$ fd. units rated at 200 volts or more.

Power transformers with electrostatic shields between the primary and secondary windings are helpful in preventing interference from being carried by the supply lines, provided the shield is connected to a good ground, and often will make extra chokes and condensers unnecessary.

Keying transients are less likely to get through to the antenna if the keying is done in a stage preceding the final amplifier. The tank circuits following the keyed stage give a band-pass effect which tends to reduce the amplitude of the transient. Keying the oscillator is desirable from this standpoint, since the oscillator is the lowest-powered stage and

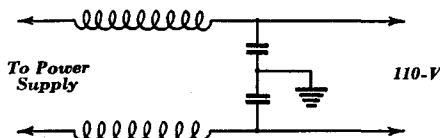

FIG. 1011 — R.F. FILTER FOR THE POWER LINE

the transients are therefore of comparatively small amplitude in the first place. Also, the maximum r.f. filtering in following-stage tank circuits is secured when the oscillator is keyed.

### Keying Methods from the Standpoint of Click Prevention

● Generally speaking, it is easier to prevent clicks if the keying method used is one in which the current in the keyed circuit is small, although there may be occasional exceptions to this rule. First choice, then, naturally would fall to those methods which key a grid rather than the plate circuit, since grid current is usually small compared to the plate current

for the same tube. This has an economic advantage as well, since the chokes comprising the key-click filter are less expensive the smaller the current they have to carry.

Probably the worst keying circuit from the standpoint of click elimination is simple plate-circuit keying of the type shown in the lower diagram of Fig. 1001. Sparking at the key usually is excessive with this circuit, which makes the problem of key-click prevention more difficult. The two upper circuits of Fig. 1001 are ideal for introducing a time lag in the keying, the power-supply filter being utilized for this purpose. However, the lag ordinarily is so great that the transmitter can not be keyed at more than a few words per minute when a filter adequate to give pure d.c. is used. With a single-section filter it may be possible to get clean keying at reasonable speeds; this type of filter may in fact be quite satisfactory to give a d.c. note if the lower-power stages are fed with well-filtered d.c. Only a trial can show whether either of these systems will work out to the operator's satisfaction. Both are prone to give rise to transients which feed back into the power line and therefore require r.f. filters at the key. In the middle drawing, the current broken by the key is much less than in the upper, so that the problem of getting suitable chokes is less bothersome.

Center-tap keying, Fig. 1003, usually is less troublesome in producing clicks than simple plate or negative high-voltage keying. However, the current interrupted by the key is comparatively large. The fact that the grid circuit is keyed along with the plate tends to lessen keying impacts.

There is little to choose between the grid-keying methods shown. In general, however, it is easier to eliminate clicks with grid keying than with either plate or center-tap keying. The keyed current usually is fairly small. The chief objection to grid-keying methods is the necessity for providing additional keying bias. This can be overcome, however, as has already been explained.

### Blanketing

● Keying transients or clicks are not the only source of interference to nearby broadcast reception, although probably the most prevalent and the type requiring the most careful attention. A second type of interference, called "blanketing" because it causes the program to disappear or come in at reduced strength whenever the key is closed, also is common. It is simply a proximity effect, the affected receiver picking up enough of the radiated energy to cause overloading of one or more of the receiver

tubes with a consequent reduction in amplification. This type of interference can be minimized by moving the broadcast antenna away from the transmitting antenna or by changing its direction. The pick-up will be least if the two antennas are at right angles to each other.

In severe cases it may be necessary to install a wave-trap at the receiver to prevent blanketing. A wave-trap consists simply of a coil and condenser connected as shown in Fig. 1012. The condenser may be an old one with about 250 or 350  $\mu\text{mf}$ . maximum capacity and need not be especially efficient. Most amateurs have "junk boxes" with several such condensers in them. The size of the coil will depend upon the frequency on which the transmitter is working. Representative values are given in the table.

Frequency of Interfering Signal	Coil (3" dia.)
1,715-2,000 kc.	20 turns
3,500-4,000 kc.	8-10 "
7,000-7,300 kc.	4-5 "
14,000-14,400 kc.	3 "

Bell wire (No. 18) or a size near to it may be used. When the trap is installed the transmitter should be started up and the condenser in the trap adjusted to the point where the interference is eliminated. This trap will not affect the operation of the broadcast receiver.

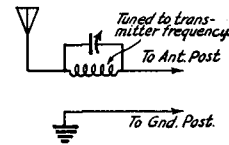

FIG. 1012—HOW A WAVE-TRAP CAN BE INSTALLED TO PREVENT CERTAIN TYPES OF INTERFERENCE

Blanketing may be and generally is accompanied by key clicks. The wave trap may help to eliminate the clicks but usually a key click filter will be needed as well. A key click filter alone cannot eliminate or even alleviate the blanketing effect.

### Low-Pass Filters for Blanketing

● The chief disadvantage of the wave-trap is that it has to be retuned if the transmitting frequency is changed from one band to another, and sometimes also if the frequency change is only from one end to the other of the same band. In such cases a better arrangement is the low-pass filter, designed to reject all received frequencies except those below a certain critical frequency. If the critical frequency is chosen just below the lowest amateur frequency used, the transmitter can be shifted from one band to another without the necessity for readjustment of a wave trap. A typical low-pass filter is shown in Fig. 1013. The con-

# The Radio Amateur's Handbook . . . . .

stants given are for a cut-off frequency of 1600 kilocycles. The filter is designed for terminating impedances of 400 ohms.

Another type of filter which has a sharper cut-off than the one just described is shown in

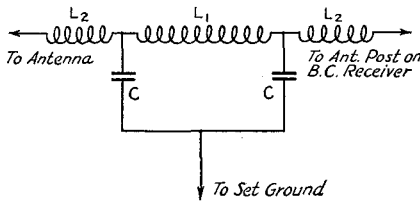

FIG. 1013 — A LOW-PASS FILTER FOR REDUCTION OF INTERFERENCE WITH BROADCAST RECEPTION

It should be installed at the receiver. Constants are as follows:  $L_1$ , 54 turns of No. 24 d.s.c. on 1 $\frac{1}{8}$ -inch diameter form;  $L_2$ , 33 turns same;  $C$ , 500  $\mu$ fd. fixed. Cutoff frequency is approximately 1600 kc.

Fig. 1014. This is of particular advantage for 'phone stations operating in the 1800- and 3900-kc. bands, since maximum attenuation is in the middle of those bands, the nominal cut-off being somewhat lower. The type A filter has greatest attenuation at 1930 kc., with cut-off beginning at 1670 kc. Type B has greatest attenuation at 3950 kc., with cut-off beginning at 2470 kc. The type A is recommended for work in several bands.

### Superheterodyne Harmonics

● A third type of interference is peculiar to superheterodyne broadcast receivers. A strong signal from the transmitter will be heard at

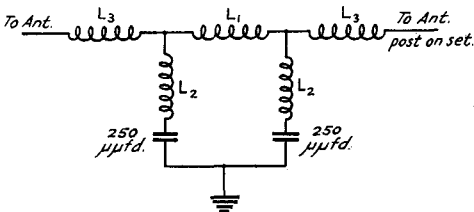

FIG. 1014 — CIRCUIT DIAGRAM OF SHARP CUT-OFF LOW-PASS FILTER

Inductance in Microhenries

Type	$L_1$	$L_2$	$L_3$
A	38	28	19
B	40	6	20

Coil Specifications

Microhenries	Turns	
6	10	No. 28 d.s.c. wire
19	18	" " "
20	19	" " "
28	24	" " "
38	29	" " "
40	30	" " "

Coils wound on 1 $\frac{1}{8}$ "-diameter form.

three or four points on the dial, while over the rest of the tuning range there may be no sign of interference. The explanation lies in the fact that the transmitted signal is picked up by beating with harmonics of the superheterodyne oscillator and amplified by the i.f. stages in the receiver. If the receiver is properly shielded and the oscillator is isolated from the antenna circuit, the signal from the transmitter cannot get into the oscillator circuit to be mixed with its harmonics and this type of interference cannot occur. When it *does* occur the fault does not lie with the transmitter but with the broadcast receiver, and nothing can be done to the transmitter to prevent such interference. A wave-trap may help if the transmitter signal is brought into the receiver through the antenna, but in some cases the pick-up is direct because the receiver is inadequately shielded,

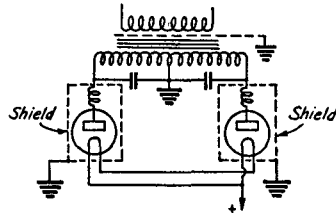

FIG. 1015 — DEVICES FOR ELIMINATING NOISE FROM MERCURY-VAPOR RECTIFIER TUBES

The r.f. chokes in series with each plate should be placed inside the shields enclosing the rectifiers. The chokes should have an inductance of about 10 millihenrys each. Small honeycomb-type windings are suitable.

and the interference is just as strong whether the antenna is connected to the receiver or not.

### Rectifier Noise

● Mercury-vapor rectifiers often are the source of a peculiar and easily identifiable type of interference which takes the form of a raspy buzz with a characteristic 120-cycle tone (100 cycles on 50-cycle power lines and 50 cycles on 25-cycle lines) often broadly tunable in spots on the broadcast receiver dial. At the instant the mercury vapor ignites on each half cycle of the power frequency an oscillation is set up, the frequency depending upon the characteristics of the power supply apparatus. Unless suitable precautions are taken the oscillations will be radiated or will travel back over the power line and be detected in receivers connected to the line.

The line filter shown in Fig. 1011 usually will suppress this type of noise. Sometimes the condensers alone will do it, no chokes being necessary. Transformers with electrostatic shields between primary and secondary are

not likely to transmit the oscillations to the line. Other ways of curing this type of interference are shown in Fig. 1015. They include shielding of the rectifier tubes, connecting a radio-frequency choke between each plate and the transformer winding, and shunting fixed condensers of about .002  $\mu$ fd. capacity between the outside ends of the transformer winding and the center-tap. The condensers should be rated to stand at least 50% more voltage than the r.m.s. voltage delivered by half of the secondary winding.

Sometimes making the plate leads to the rectifiers extremely short will be sufficient to eliminate the interference.

#### Checking for Interference with Broadcasting

● One's own broadcast receiver, if of modern design, is a good "subject" for experimenting with key click filters and other interference-prevention methods. If interference can be eliminated in a receiver in the same house, operating from the same power line and with an antenna close to the transmitting antenna, the chances are good that there will be no general interference in the neighborhood. The amateur should ascertain, however, whether or not interference is caused in nearby broadcast receivers. If your neighbors appreciate that you are as much interested in preventing interference to their enjoyment of broadcast programs as they are, much more can be accomplished than by acrimonious disputes. It is better to settle the interference problem right at the beginning than to trust to luck with the possibility of an unfavorable reaction towards amateur radio in general and yourself in particular on the part of nearby broadcast listeners.

In searching for causes of interference, it is a good idea to have someone operate your transmitter while you listen on the affected receiver. Remove the antenna from the receiver, and if the interference disappears it is certain that it is coming into the set through the antenna, which simplifies the problem. The various types of interference prevention already described should work under these conditions. If the interference persists when the antenna is removed, however, it is probably getting into the receiver through the power lines. This happens occasionally with a.c. operated broadcast receivers.

House wiring may pick up r.f. either directly from the antenna or through the power-supply system of the transmitter. If the 110-volt line is found to be picking up energy directly from the antenna it is advisable to change the location of the antenna, if possible, or run it in a

different direction, not only because of interference to broadcast reception but because energy so picked up is useless for radiation and decreases the effective range of the transmitter. This is particularly important when, as often happens, electric lamps in different parts of the house are found to glow when the key is pressed. The energy used in lighting the lamps is wasted.

If r.f. is found to be getting into the line through the power-supply equipment, a line filter such as is shown in Fig. 1010 should be used, together with power leads in grounded BX.

Interference usually decreases as the transmitter frequency is raised. In many cases where bad interference is caused on the 1750- and 3500-kc. bands, changing to 7000 or 14,000 kc. will cure it. If none of the usual methods is wholly effective a reduction in power often will allow the station to be worked during the evening hours without bothering the neighbors.

#### Radiophone Interference

● Key-click filters are naturally of no value on transmitters used exclusively for 'phone transmission, since clicks do not occur. A phenomenon similar to key clicks can take place if the transmitter suffers from frequency modulation or from over-modulation, because both these defects cause the radiation of side-bands often far removed from the band of frequencies normally required for the transmission of speech. These abnormal side-bands can and frequently do cause interference in the broadcast band, often just as a series of unintelligible noises when the transmitter is modulated. The obvious remedy is to use a radio frequency system in the transmitter whose frequency does not vary when modulation is taking place, and to adjust the transmitter so that over-modulation or "lop-sided" modulation does not occur. Chapter Eleven covers this subject thoroughly.

Blanketing and other forms of interference caused by r.f. pickup can be treated in exactly the same way as described previously. Wave-traps or low-pass filters in the receiving antenna lead-in and r.f. filters in the power lines will prove effective in eliminating this type of interference.

Occasionally signals from a radiotelephone transmitter may be picked up on near-by telephone circuits causing interference to users of the telephone. In most cases, this may be cured by connecting a mica by-pass condenser of .001  $\mu$ fds. capacity or greater across the terminals of the telephone microphone.

# II

## Fundamentals of Radiotelephony

### PRINCIPLES OF MODULATION AND 'PHONE TRANSMITTER CIRCUIT DESIGN

IN THE discussion of modulation and detection in Chapter Four, it was pointed out that both radio telegraph and radio telephone transmission require modulation in order that the transmitted wave may convey intelligence to the receiver. In subsequent chapters we have seen how this modulation is applied in relatively simple form for c.w. telegraph. In this chapter we shall take up the principles and methods involved in speech modulation for radio telephone communication. It must be realized that radiotelephony is much more complicated than c.w. telegraphy, not only in the amount of apparatus involved but also in its technical aspects. The 'phone transmitter not only must have radio-frequency equipment typical of the good c.w. set and additional audio-frequency equipment to accomplish voice modulation, but also there must be careful coördination of the r.f. and audio sections to insure that the outfit's performance meets modern requirements. Satisfaction of these requirements can be realized by following the established and proved design and adjustment procedure which will be given. The information is based on actual experience in practical amateur transmitter construction and operation.

#### Principles of Modulation

● *Amplitude modulation for voice transmission is the process by which the amplitude of the trans-*

*mitted radio-frequency wave is varied in accordance with the sound waves actuating the microphone.* When such a wave is detected in the receiver, as explained in Chapter Four, there should result a true reproduction of the original modulating signal which, in amateur 'phone, would be the speech of the operator at the transmitting station. The degree of amplitude modulation is described in terms of the amplitude variation of the transmitted wave, and is usually given as a decimal modulation factor or as a percentage. *The modulation factor, expressed in percentage, is 100 times the maximum departure (positive or negative) of the envelope of a modulated wave from its unmodulated value, divided by its unmodulated value.* If the modulation is *undistorted* or *linear*, the average amplitude of the modulated wave is the same as its unmodulated value, so long as the modulating signal also is symmetrical. These basic definitions are very important and should be thoroughly memorized and understood.

Graphic illustration of modulation of a radio wave is given in Fig. 1101, in which *C* shows an actual cathode-ray oscilloscope reproduction of the unmodulated carrier, *D* shows this carrier modulated approximately 50 per cent, and *E* shows the carrier completely modulated by a single-tone signal of the good wave form pictured in *A*. The picture *B* of this figure shows undesirable distortion of the modulating signal.

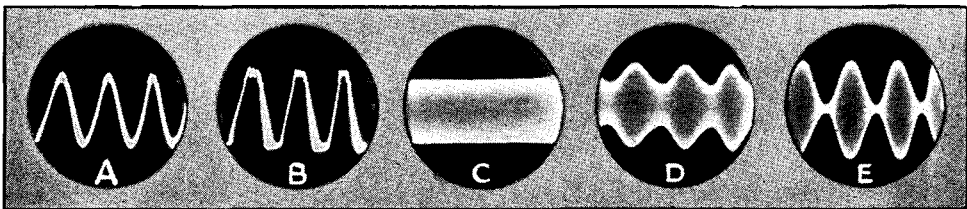

FIG. 1101 — PICTURE A SHOWS THE WAVE FORM OF THE 500-CYCLE MODULATING SIGNAL WITH THE AUDIO STAGES OPERATING PROPERLY

*B* shows the same audio signal with distortion from over-excitation of the Class-B driver stage. *C* pictures the unmodulated carrier and *D* the carrier modulated approximately 50% with good wave form. *E* represents the carrier properly modulated 100 per cent.



# Fundamentals of Radiotelephony

Fig. 1102 gives conventionalized sketches of amplitude modulation, with the amplitude relations for determining percentage modulation indicated. In form of an equation, the expression for percentage modulation is

$$\% M = \frac{i_{mod} - i_{car}}{i_{car}} \times 100,$$

where  $i_{mod}$  is the maximum amplitude (the positive peak), or the minimum amplitude (the negative peak), and  $i_{car}$  is the unmodulated carrier amplitude. In the case of *over-modulation* as shown by C, the positive percentage is greater than 100. However, the negative percentage can never be greater than 100 because the amplitude cannot become less than zero. Such a condition results, obviously, in a distortion of the wave envelope—the envelope being the outline of the radio-frequency cycle peaks.

Such distortion not only affects the quality of the received signal but also broadens the communication band of the transmission and causes needless interference. This broadening results from the fact that unnecessary side-band frequencies are generated. As was pointed out in Chapter Four, the process of modulation produces additional radio frequencies in pairs either side of the carrier frequency, constituting the *side bands*. There will be one such pair for each frequency component in the modulating signal. If the wave form is distorted, as it will be with overmodulation, there will be further side bands generated and these spurious radiations will broaden the wave accordingly. It is for this reason that government regulations prohibit overmodulation.

In connection with the dual nature of side bands in the type of transmission under discussion, it should be pointed out that the intelligence conveyed by the modulated wave is all contained in the side-band components. Our present technical methods necessitate the transmission of the carrier and both side bands, although it is theoretically possible to communicate with the carrier suppressed and only the two side bands transmitted, or with the carrier and a single side band transmitted, or even with the carrier suppressed and only a single side band transmitted. The carrier is only useful for beating with the side-band components to reproduce the original signal in the receiving detector. Hence, it is possible to dispense with transmission of the carrier and use a locally-generated carrier in the receiver to serve the purpose. However, single-side-band technique is not yet sufficiently developed to make it economically feasible for amateur work, although it is being used on high fre-

quencies to a limited extent in experimental commercial communication.

### Amplitude and Power Relations

● The maximum permissible modulation factor, imposed by the requirements that the

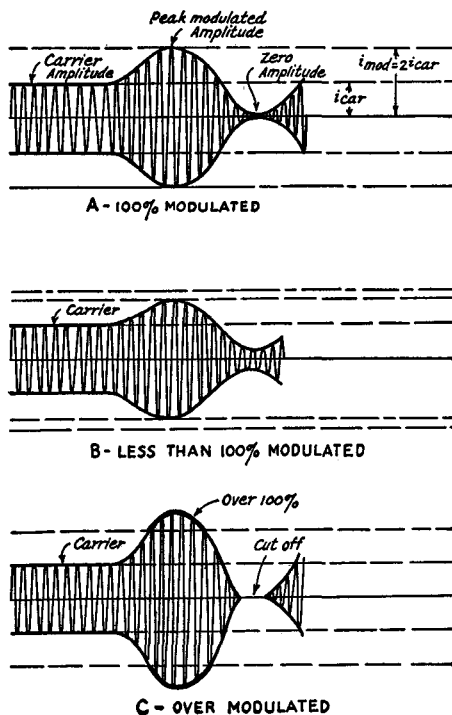

FIG. 1102 — GRAPHICAL REPRESENTATION OF THE AMPLITUDE MODULATED WAVE

C illustrates the condition of overmodulation, the negative peak of the envelope being cut off. The outline of the r.f. peaks is the envelope and should correspond to the wave shape of the modulating signal.

modulation envelope shall not be distorted, is 100 per cent. This limit is reached when the total amplitude of the two side bands equals the amplitude of the carrier, each side band therefore having a total amplitude equal to one-half the carrier amplitude. Since the amplitude is doubled at 100 per cent modulation, the instantaneous *peak power* will be four times the unmodulated power, power being proportional to the square of the current. With continuous modulation by a single pure tone the *average power* will be 50 per cent greater than the unmodulated power, in accordance with the effective evaluation for complex waves which was given in Chapter Three. That is, the carrier and the two side bands represent three different frequency

# The Radio Amateur's Handbook . . . . .

components of which the carrier would have an effective value of 1 and the side bands each an effective value of 0.5. The square root of the sum of the squares of these three effective current (or voltage) values would be 1.226. Power being proportional to the square of the current, the average power value at 100 per cent sinusoidal modulation would be  $1.226^2$  or 1.5. Speech, however, is of complex form. Experience has shown that for the most practical purposes it can be taken as equivalent to two tones of equal amplitude. The maximum total amplitude restriction necessitates, therefore, that the total amplitude of the four equivalent side-frequency components shall be no greater than the carrier amplitude; the two frequency components in the modulating signal are altogether likely to be in phase aiding at least occasionally. With such a modulating signal, the instantaneous *peak power* at 100 per cent modulation also would be four times the unmodulated power. However, the *average power*, by the root-sum-square calculation, would be 1.25 times the unmodulated power, or 25 per cent greater than the unmodulated power. The effective current would be 1.12 times the unmodulated effective current value. Hence, although a radio-frequency ammeter in the antenna circuit would show an increase in current reading of slightly more than 22 per cent with 100 per cent sustained modulation by a sinusoidal signal, the sustained speech-equivalent signal would give an effective current reading only 12 per cent greater than the unmodulated reading. Moreover, the varying nature of speech modulation would give a considerably smaller percentage increase in practical operation, because of the sluggishness of such measuring instruments and their inability to indicate truly the maximum effective current value. From experience, a reading increase of only about 5 per cent should be obtained with usual speech.

## Modulation Capability and Stability

● It is entirely possible for the modulation envelope to be distorted at less than 100 per cent modulation, as in a transmitter which was incapable of increasing the maximum amplitude to twice the unmodulated amplitude. *Modulation capability is the maximum percentage modulation that is possible without objectionable distortion.* It is apparent that the modulating system, whatever type, must be able to effect an undistorted variation in the amplitude of the modulated wave ranging from zero to twice the carrier amplitude if the set is to have a modulation capability of 100 per cent. Since the effectiveness of a modulated

wave as measured by receiver response depends on the variation in amplitude, it is desirable that the transmitter's modulation capability be high. As a specific instance, a ten-watt carrier modulated 100 per cent is practically as effective as a 40-watt carrier modulated 50 per cent.

With transmitters of high-percentage modulation capability, particular care must be exercised to prevent variation in the carrier frequency as an accompaniment to amplitude modulation. Such variation constitutes *frequency modulation*. It has been shown that frequency instability is a serious defect in c.w. telegraph transmission, and it must be realized that frequency modulation is far more objectionable in 'phone transmission. It not only causes unnecessary interference with other stations working on adjacent frequencies in the same amateur band, but also can cause interference with services operating on greatly different frequencies. An amateur 'phone working on the 3900-kc. band is even likely to cause interference on the broadcast band, as a result of frequency modulation accompanying amplitude modulation. The combination may cause radiation of spurious frequencies over a band as wide as several hundred kilocycles. Frequency modulation is also a cause of distortion in reception. Modulation of the oscillator in amateur transmitters is therefore prohibited except on the ultra-high frequency bands. Even when a radio-frequency amplifier following an oscillator is modulated, precautions are necessary to insure against affecting the oscillator's frequency. An extremely stable oscillator is necessary, with provision for isolating it from the modulated stage as by an intervening buffer amplifier.

## Basic Methods of Modulation

● The most widely used type of modulation system is that in which the modulating signal is applied in the plate circuit of a radio-frequency power amplifier (*plate modulation*). In a second type the audio signal is applied to the control-grid circuit (*grid-bias modulation*). A third system involves variation of the suppressor-grid voltage of a pentode-type power tube (*suppressor-grid modulation*). Other systems are occasionally used for special purposes but are not generally suitable for amateur work. Among these is screen-grid modulation in an amplifier using that type tube (limited to approximately 60 per cent modulation capability). Practical arrangements illustrative of plate and grid-bias methods are diagrammed in Fig. 1003. The suppressor-grid modulation system is shown in Fig. 1104.

# Fundamentals of Radiotelephony

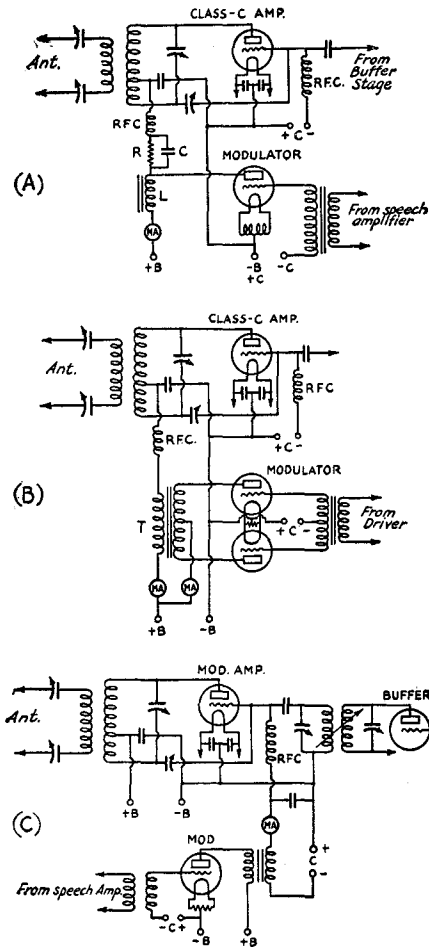

FIG. 1103 — CIRCUITS FOR THREE METHODS OF MODULATION

A and B are for plate modulation, C for grid-bias modulation.

In A of Fig. 1103 is shown the circuit of what is known as the Heising or constant-current system of plate modulation. The plate power for the modulator tube and modulated amplifier is furnished from a common source through the modulation choke,  $L$ , which has high impedance for audio frequencies. When the grid circuit of the modulator tube is excited at audio frequency, the modulator operates as a power amplifier with the plate circuit of the r.f. amplifier as its load, the audio output of the modulator being superimposed on the d.c. power supplied to the amplifier. The r.f. output of the amplifier is

therefore identically modulated. For 100 per cent modulation the modulator audio voltage applied to the amplifier plate circuit across the choke,  $L$ , must have a peak value equal to the d.c. voltage on the modulated amplifier. To obtain this without distortion, the amplifier must be operated at a d.c. plate voltage less than the modulator plate voltage, the extent of the voltage difference being determined by the type of modulator tube used. The necessary drop in voltage is provided by the resistor  $R$ , which is by-passed for audio frequencies by the condenser  $C$ .

In Fig. 1103-B is shown another system of plate modulation in which a balanced (push-pull Class-A, Class-AB or Class-B) type modulator is transformer-coupled to the plate circuit of the modulated r.f. amplifier. When the grids of the modulator tubes are excited, the audio-frequency power generated in the plate circuit is combined with the d.c. power in the modulated-amplifier plate circuit by transfer through the coupling transformer,  $T$ . The power output of the modulated amplifier varies exactly with the power input to its plate, and the carrier power is therefore varied in accordance with the signal at the grids of the modulator tubes. For 100 per cent modulation the audio-frequency output of the modulator and the turns ratio of the coupling transformer must be such that the voltage at the plate of the modulated amplifier varies between zero and twice the d.c. operating plate voltage. The plate efficiency with plate modulation of Class-C amplifiers is practically constant at approximately 65 per cent.

In C of the same figure is the diagram of a typical arrangement for grid-bias modulation. In this system, the secondary of an audio-frequency output transformer, whose primary is in the plate circuit of the modulator tube, is

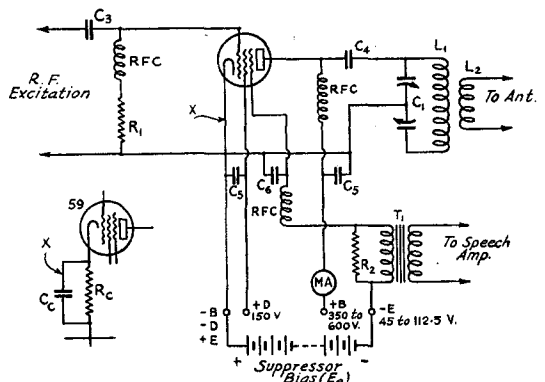

FIG. 1104 — CIRCUIT OF THE SUPPRESSOR-GRID MODULATED R.F. AMPLIFIER

connected in series with the grid-bias supply for the modulated amplifier. When the grid bias, radio-frequency excitation and load circuit of the modulated amplifier are properly adjusted, power output will vary in accordance with the audio-frequency signal applied to the control grid. In this method of modulation the modulator stage furnishes relatively small power to the r.f. amplifier's control-grid circuit. The carrier plate efficiency of the modulated stage is considerably lower than with plate power modulation, being of the order of 30 per cent or somewhat less in usual practice. At 100 per cent modulation it rises to approximately 60 per cent.

The circuit arrangement for suppressor-grid modulation of a pentode type tube is shown in Fig. 1104. In this system the modulating signal is also applied to a grid, in which respect it is akin to control-grid modulation. However, it differs in that the r.f. excitation and modulating signals are applied to separate grid elements. This gives the system a simpler operating technique. Best adjustment for proper excitation requirements and, simultaneously, proper modulating circuit requirements, are

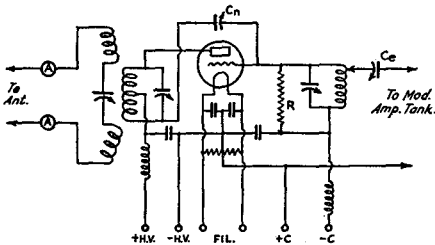

FIG. 1105 — CIRCUIT OF A SINGLE-ENDED CLASS B LINEAR R.F. AMPLIFIER

The grid-regulation resistor,  $R$ , should be capable of dissipating a fair proportion of the exciting amplifier's power output. The excitation can be regulated by the coupling condenser,  $C_c$ , or by adjustment of the regulating resistor, or a tap on the exciting amplifier tank coil. The circuit values can be as usual for the frequency and power.

more or less independent, whereas they are intermingled in the control-grid circuit of the previously outlined system. The carrier plate efficiency figure is approximately the same as for control-grid modulation, approximating 30 per cent, rising to approximately 60 per cent at full modulation. With tubes having suitable suppressor-grid characteristics, linear modulation up to practically 100 per cent can be obtained with negligible distortion.

**Class-B Linear Amplifiers**

● When the final r.f. stage of the transmitter is modulated, it is considered as a *high-level*

system, since modulation takes place at the highest power level in the transmitter. If the modulation takes place in an intermediate stage with a higher-power r.f. amplifier stage

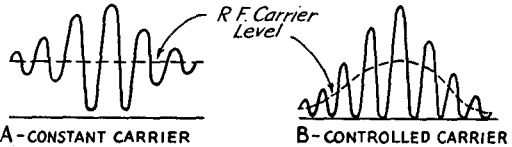

FIG. 1106 — CONTRASTING MODULATED WAVES OF THE CONSTANT-CARRIER TYPE (A) AND CONTROLLED-CARRIER TYPE (B)

or several such stages following, it is called *low-level* modulation. Amplifiers so used to increase the power output from a low-level stage are operated as *linear amplifiers*. Such amplifiers are operated under Class-B conditions, as described in Chapter Five, with minor modifications in the circuit to maintain the output power proportional to the square of the excitation voltage over the range of amplitude with modulated excitation. The circuit of a Class-B linear amplifier stage is shown in Fig. 1105. The principal modification usually required is the r.f. load resistor  $R$  which serves to improve the r.f. voltage regulation of the modulated exciter's plate circuit. Some such stabilization is necessary because the input impedance of the linear stage varies considerably with variation in the amplitude of the modulated r.f. excitation. A Class-B linear stage should be operated as a "straight" amplifier; that is, its output should be on the same frequency as the input. If operated as a frequency doubler, the depth of modulation will be increased in the output, and spurious frequencies are likely to be generated. Plate efficiency is of the same order as with grid modulation.

**Controlled-Carrier Transmission**

● In the above systems as outlined, the carrier amplitude is maintained constant and the percentage modulation varied in accordance with the modulating signal. That is, these systems are *constant-carrier* types, and the carrier power radiated is always the same regardless of whether the modulation is shallow or deep, or even when there is no modulation at all. Since speech is not only of varying amplitude but is also intermittent, the average efficiency with constant-carrier transmission is quite small. Also, the heterodyne interference created is just as bad when the carrier is unmodulated as when it is fully modulated, and its nuisance effect is disproportionate to its utility. The deficiencies can be overcome to a considerable extent if the carrier amplitude is

automatically varied to maintain it just sufficient to accommodate the various modulating signal amplitudes as they occur. A system in which this is accomplished is called a *controlled-carrier* system.

The essential difference, so far as the modulated wave is concerned, between constant-carrier and controlled-carrier is illustrated in Fig. 1106. The principle is to vary an operating control in the transmitter automatically by the modulating signal so that the carrier amplitude is approximately proportional to the average of the modulating signal. This control must be fast enough in operation to follow normal syllabic variations in speech intensity, but not so fast as to follow the individual cyclic variations of audio frequency. The most satisfactory methods of control for voice transmission employ vacuum tubes as speech-operated variable resistances to vary the average plate power input of transmitters using plate modulation, or to vary excitation to a grid-bias modulated stage, or to vary the suppressor-grid bias with that system of modulation. Practical details of controlled-carrier transmitting circuits are given in the next chapter.

### **The Plate-Modulated R.F. Amplifier**

● For distortionless or linear plate modulation with 100-per cent modulation capability (sinusoidal signal), the modulated r.f. amplifier should operate with a steady d.c. power input equal to twice the modulator's maximum rated undistorted power output and should, simultaneously, present a load or *modulating impedance* to the modulator equal to the modulator's rated plate load impedance. To satisfy these conditions it is necessary that the modulated r.f. amplifier operate so that its plate circuit presents a constant resistance of proper value as viewed from the modulator's output, the value of this load resistance in ohms being the r.f. amplifier d.c. plate voltage (volts) divided by its d.c. plate current (amperes).

This condition obtains when the modulated stage operates as what is known as a Class-C amplifier; that is, so that its power output is proportional to its plate power input, as described in Chapter Five. The plate current and output current vary as the plate voltage between the limits of zero plate voltage and twice the mean plate voltage. This is accomplished by operating the modulated amplifier with a negative grid bias more than sufficient to reduce the plate current to zero with no excitation (usually twice "cut-off" bias)

and by supplying the grid with r.f. excitation sufficiently ample to cause plate current saturation. Grid bias may be obtained from a fixed-voltage source (batteries), or by means of a grid leak, or by a combination of fixed and leak bias in series, or by a dropping resistor in the negative (cathode) circuit. A combination of automatic grid-leak bias and cathode-drop bias is desirable for full-range linear modulation.

When the amplifier's operation is truly Class-C, its plate circuit input resistance, as viewed from the modulator output, will be equal to the mean plate voltage divided by the plate current. Also, the product of the plate voltage and current is the unmodulated power input, equal to twice the modulator's maximum audio power output for 100 per cent modulation. Therefore, regardless of the type, size or number of tubes used in the Class-C amplifier, its mean plate voltage and plate current will be the same for a given modulator.

The tubes most suitable for use in modulated Class-C amplifiers are those designated for r.f. power amplifier use, such as are listed in the transmitting tube table of Chapter Seven. Triodes in a neutralized circuit, are capable of making best use of the modulator audio power output. Screen-grid tubes are also used but require simultaneous modulation of both plate and screen voltages. Tubes chosen for Class-C amplifier operation should have plate voltage and current ratings that will not be exceeded in modulated service. Excessive plate voltage or plate current will not only shorten the life of the tube but also may cause non-linear modulation, distortion and interfering spurious radiation. This applies particularly to receiving-type tubes (such as the 46) when operated as modulated Class-C r.f. amplifiers.

It must be remembered that the power input to the Class-C modulated stage is not just the d.c. plate voltage and plate current product. The audio-frequency power is superimposed on this average input, and with 100 per cent modulation by a sinusoidal signal will be 50 per cent greater than the average power indicated by d.c. meters and approximately 25 per cent greater with a speech signal, in accordance with the explanation of pulsating current calculation given in Chapter Three. Hence, the maximum plate dissipation may be 50 per cent greater than the d.c. meter readings might lead one to believe. Allowance for this additional dissipation should be made in choosing the plate voltage. Plate-voltage ratings for Class-C modulated amplifiers are usually about 25 per cent less than the maximum allowable for c.w. service with the same tubes.

## Coupling Calculations for Plate Modulation

● With a modulator of given power output and load resistance (or impedance) requirement, calculation of the proper plate input to the Class-C amplifier and of coupling circuit values can be made quite easily. Determination of Class-A load impedance and power output from the tube plate characteristics is described in Chapter Five. In the case of a Class-A modulator with choke coupling to the Class-C amplifier plate circuit, as shown in Fig. 1103-A, the procedure is as follows:

As has been stated, for 100 percent sinusoidal modulation the Class-C amplifier d.c. input power should be twice the modulator's rated maximum undistorted power output (u.p.o.). This input will be equal to the product of the Class-C amplifier's mean (d.c.) plate voltage and plate current. At the same time, the mean plate voltage divided by the plate current gives the *modulating impedance*, which in this case should equal the modulator's rated load impedance. By Ohm's law,

$$I_b = \sqrt{\frac{P_o}{R_p}} \text{ and } E_b = \frac{P_o}{I_b}$$

where  $P_o$  = unmodulated d.c. power input to r.f. stage = *twice modulator power output, watts.*

$R_p$  = optimum load resistance for modulator, ohms.

$I_b$  = mean current to r.f. amplifier plate, amperes d.c.

$E_b$  = r.f. amplifier mean plate voltage, d.c.

For the case of a Type 845 tube operating as a Class-A modulator with plate supply of 1000 volts at 75 ma. (grid bias -147 volts), the rated power output with negligible distortion is 23 watts for a load resistance of 7500 ohms (See Class-A modulator table). Substituting in the above equations,

$$I_b = \sqrt{\frac{2 \times 23}{7500}} = 0.078 \text{ amp.} = 78 \text{ ma.},$$

the Class-C amplifier d.c. plate current.

$$E_b = \frac{2 \times 23}{0.078} = 590 \text{ volts,}$$

the Class-C amplifier d.c. plate voltage.

The plate voltage drop for the Class-C amplifier is, therefore, 1000-590=410 volts. The proper resistance value for the dropping resistor,  $R$  of Fig. 1103-A, is this value divided by the Class-C amplifier plate current,

$$R = \frac{410}{0.078} = 5256 \text{ ohms (5250 ohms satisfactory).}$$

The dissipation rating of this resistor should equal the voltage drop multiplied by the current, or  $410 \times 0.078 = 32$  watts. A 50-watt type resistor therefore would be satisfactory. It should be by-passed for audio frequencies by condenser  $C$  (2- $\mu$ fd. or larger). A coupling choke,  $L$ , of 30-henry *effective* inductance at 150-ma. d.c. will be suitable. Any one of several tubes capable of operating with 78 or 80 ma. input at 590 or 600 volts could be used in the Class-C amplifier; an RK-31, 830, RK18 or 800 would be a likely choice.

In the case of transformer coupling between the modulator and Class-C amplifier, as shown in Fig. 1103-B, the procedure is somewhat different. This method of calculation is generally applicable to any type of modulator, Class-A or Class-B, with transformer coupling. The purpose is to calculate the turns ratio of the transformer to match the modulating impedance of the Class-C amplifier to the required load impedance of the modulator. For illustration, take the case of a modulator using a pair of Type 800 tubes in Class-B, operating at a plate voltage of 1000 volts (See Class-B modulator table). The rated power output with negligible distortion is 100 watts and the plate-to-plate load impedance is specified as 12,500 ohms. The Class-C amplifier using two similar tubes is to operate at the same plate voltage, 1000 volts, with a mean (d.c.) power input of twice the modulator's rated maximum output, or 200 watts. The Class-C amplifier plate current is, therefore,

$$I_b = \frac{P_o}{E_b} = \frac{2 \times 100}{1000} = 0.2 \text{ amp.} = 200 \text{ ma.}$$

The modulating impedance of the Class-C amplifier is

$$Z_m = \frac{E_b}{I_b} = \frac{1000}{0.2} = 5000 \text{ ohms.}$$

The transformer therefore must match a 5000-ohm load to the modulator's 12,500-ohm load requirement. This calls for a step-down transformer having an impedance ratio of 12,500 to 5000. The turns ratio, *total primary to total secondary*, will be the square root of the impedance ratio.

$$\text{Turns Ratio} = \sqrt{\frac{12,500}{5000}} = \sqrt{2.5} = 1.58 \text{ to } 1$$

(or 1 to 0.63).

In the case of Class-B output transformers it is customary to specify the turns ratio of  $\frac{1}{2}$  *primary to total secondary*, which would be 1 to 1.26 in the example given. In the actual design of the transformer the secondary turns would

# Fundamentals of Radiotelephony

be increased slightly over the theoretical calculated value, to allow for losses. Manufactured types having suitable characteristics for standard modulator combinations are widely available at reasonable prices. The transformer may be designed to carry the Class-C amplifier d.c. plate current through its secondary without saturating the core. Otherwise it will be necessary to feed the amplifier plate d.c. through an audio-frequency choke and couple the transformer, across the choke, through a large condenser.

## Economy Class-B Modulation for Speech Only

● Although it is customary to calculate modulator power requirements on the basis of a sine-wave modulating signal, a somewhat smaller modulator power capability is possible in the case of the Class-B modulator which is to be used only for speech transmission. We have shown that the *average* power in a speech signal is approximately half as great as the average power in a sinusoidal signal of equal amplitude. Hence, although the maximum amplitude and peak power values are the same with either type of signal, giving the same amplitude limitation in the design procedure for both, the power dissipation limitation is modified in the case of speech. With Class-A modulators this does not apply because the power ratings have to be based on the no-signal condition, during which the plate must dissipate the entire d.c. input.

In general, doubling the unmodulated Class-C amplifier input for a given Class-B modulator tube combination necessitates an increase in the modulator plate voltage, an increase in audio driving power and perhaps also a change in the output transformer ratio. The modulator tubes must be capable of operating at this increased plate voltage and supplying the peak emission demanded. The application is thereby restricted to certain types of tubes as Class-B modulators, the design being determined from the characteristic curves and ratings. Details of such a modulator unit are given in the next chapter.

## Speech Input Circuits—Types of Microphones

● A microphone is the device used to convert the sound waves of speech into corresponding alternating currents or voltages which, after amplification, excite the modulator. Typical circuit arrangements of five types of microphones generally used in amateur transmitters are shown in Fig. 1107. The arrangement of A

is for a single-button carbon microphone; B is for a double-button carbon microphone; C is that of a condenser microphone; D is for a ribbon (velocity) type; and E is for piezo-electric (crystal) type microphone.

Carbon-grain microphones, both single- and double-button, convert sound waves into pulsating electrical current by the variation in the resistance with pressure between carbon granules in contact with a metal or graphite diaphragm which is caused to vibrate by the sound waves striking it. In the single-button microphone,  $M_1$  of A, one connection is made to the diaphragm and the other is made to the cup containing the carbon granules, called a button. The microphone terminals are connected

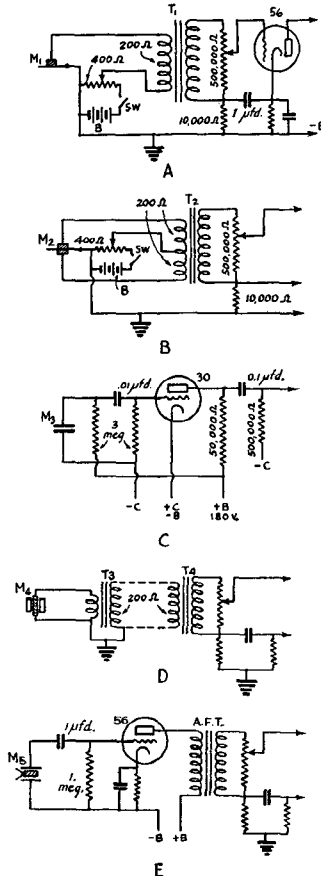

FIG. 1107 — SPEECH INPUT CIRCUIT ARRANGEMENTS FOR FIVE GENERALLY USED TYPES OF MICROPHONES

$M_1$ , single-button carbon;  $M_2$ , double-button carbon;  $M_3$ , condenser;  $M_4$ , ribbon or velocity type;  $M_5$  crystal type.

in series with a variable resistor (to adjust microphone current), which is connected across a battery, and the primary winding of a transformer. The current through the primary is a pulsating direct current which induces alternating voltage in the secondary winding. This voltage in turn is applied to the grid circuit of the speech-amplifier tube. In the double-button microphone,  $M_2$  of *B*, there is a cup of carbon granules on each side of the diaphragm. These "buttons" are connected to the two ends of the primary winding of the microphone transformer and the diaphragm is connected in series with a battery to the center of the winding as shown in *B*. The granules in one button are compressed and their resistance is reduced while the granules on the other side loosen and their resistance is increased when the diaphragm is vibrated, with the result that there is an increase in current flow between one button and the diaphragm while there is a decrease in current flow between the other button and the diaphragm. The average current flow through the common circuit and the battery will remain constant if the buttons have been properly adjusted. The diaphragm of the "high-quality" double-button microphone is "stretched" to make its natural resonant frequency well above the normal audio-frequency range. This makes the microphone's sensitivity comparatively low but improves its frequency characteristic. More sensitive double-button microphones have an "unstretched" metal or graphite diaphragm.

The condenser microphone illustrated in *C* utilizes an entirely different principle — that the variation in electrostatic capacity between two plates causes a change in the potential difference between them. In the microphone one of the plates is fixed and incapable of vibration but the other is of thin metal, tightly stretched, separated from the fixed plate by about a thousandth-inch. A high d.c. potential, which may be obtained from the amplifier "B" supply, is applied between the plates and the variation in the potential which results when the thin plate vibrates in response to a sound wave is applied across a high resistance (several megohms) in the grid circuit of an amplifying tube.

The velocity or ribbon-type microphone,  $M_3$ , operates on the electromagnetic principle. A light corrugated ribbon of conductive material, such as dural, is suspended with slight tension between the poles of an electromagnet so that its motion will be transverse to the magnetic field. When vibrated by sound waves, the ribbon conductor cuts the magnetic lines of force and a corresponding alternating cur-

rent flows through the ribbon and the primary of a transformer in its external circuit. The impedance of the ribbon is very small, a few ohms, permitting the use of a transformer with a small primary and large turns (voltage) step-up ratio for coupling to the grid of the first amplifier. The frequency response of this type microphone is very uniform over the audio range, since its inherent characteristics are such that the voltage generated is proportional to the amplitude of the sound wave and nearly independent of frequency, the velocity of the ribbon being proportional to the sound-wave intensity. For this reason this type of dynamic microphone is also known as the "velocity" microphone. A somewhat different type of dynamic microphone has a low-impedance coil mechanically coupled to a diaphragm, the electrical current being induced in the coil by motion caused by sound waves. The moving-coil type microphone is relatively more complex and expensive than the ribbon type and is not so widely used for amateur work.

The input circuit for a piezo-electric or crystal type microphone is shown in Fig. 1107-E. The element in this type consists of a pair of Rochelle salts crystals cemented together, with plated electrodes. In the form diagrammed, the crystal is mechanically coupled to a diaphragm. Sound waves actuating the diaphragm cause the crystal to vibrate mechanically and, by piezo-electric action, to generate a corresponding alternating voltage between the electrodes, which are connected across the grid circuit of a vacuum tube amplifier as shown. This electro-mechanical action is the reverse of that utilized with the quartz crystals used in transmitters and described in Chapters Eight and Nine. Unlike the other microphones described, the crystal type requires no separate source of current, polarizing voltage or magnetic field. The diaphragm type illustrated has frequency characteristics entirely adequate for speech transmission. Another type, which has no diaphragm and in which the crystal is directly actuated by sound waves, has more uniform response over a wider range of audio frequencies (up to 10,000 cycles or more) as is required for program transmission.

Wide-frequency response speech input equipment is not required for voice transmission, uniform frequency response up to 2800 or 3000 cycles being adequate. It is therefore satisfactory to choose a microphone intended particularly for speech transmission, rather than one designed primarily for broadcast program use. Since the high r.f. selectivity of modern amateur 'phone receivers and the use of "tone controls" in receiver audio systems cut off the



# . . . . . Fundamentals of Radiotelephony

higher frequencies anyway, the transmitted modulation frequencies above 3000 cycles are largely wasted.

### Microphone Output Levels

● The sensitivity of the microphone — that is, its electrical output for a given speech intensity input — governs the amount of amplification required between the microphone and the modulator. Sensitivity varies greatly with microphones of different basic types, and also varies between different models of the same type. The output is also greatly dependent on the character of the individual voice and the distance of the speaker's lips from the microphone, decreasing approximately as the square of the distance. It also may be affected by reverberation in the room. Hence, it is practically impossible to give rigid speech output values which will be reproducible in every instance. At best, only approximate values based on averages of "normal" speaking voices can be attempted. These have been obtained through the cooperation of several microphone manufacturers and are representative of the types of microphones most popularly used by amateurs. They are based on close talking; that is, with the microphone six inches or less from the speaker's lips, or with the microphone against the cheek, slightly to one side of the speaker's lips.

Good quality single-button carbon microphones give outputs ranging from 0.1 volt across 50 or 100 ohms to 0.3 volt across 50 to 100 ohms; that is, across the primary winding of the microphone transformer. With the step-

so can be assumed available at the first speech amplifier grid. The button current with this type microphone ranges from 10 or 15, to 50 ma. per button. The operating conditions recommended by the manufacturer should be followed.

The output of condenser microphones varies widely from one model to another, the high quality type being about one-hundredth to one-fiftieth as sensitive as the standard double-button carbon mike. Usually an additional resistance-coupled amplifier having a voltage gain of approximately 100 (40 db) is satisfactory as a "pre-amplifier" for adapting a double-button set-up to condenser mike input.

The sensitivity of the velocity or ribbon-type microphone is between that of the standard double-button carbon and the condenser type. With a suitable microphone coupling transformer, about one stage of pre-amplification having a tube gain of 10 or so will bring the level up to that obtained at the grid of the first tube with a standard double-button microphone.

Although the sensitivity of piezo-electric crystal microphones varies with different models, output of 0.005 volt is representative for amateur communication types and this figure has been found generally satisfactory for speech amplifier design purposes. The sensitivity of this type microphone is affected by the length of the leads connecting to the grid input of the first amplifier stage, decreasing as the lead length and capacitance are increased. The above sensitivity figure is for connecting cable lengths of 6 or 7 feet. The frequency

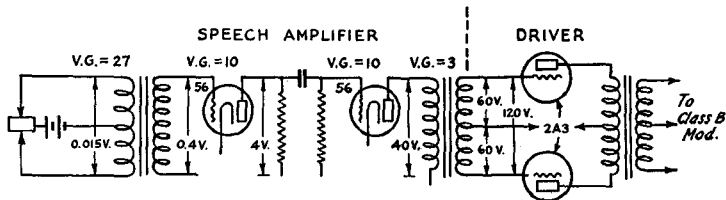

FIG. 1108 — SKELETON DIAGRAM OF SPEECH-AMPLIFIER AND DRIVER STAGES, SHOWING APPROXIMATE VOLTAGE GAIN AND PEAK VOLTAGE PER STAGE

up of the transformer, a peak voltage of between 2 and 3 volts across 100,000 ohms or so can be assumed available at the grid of the first tube. These microphones are usually operated with a button current of about 100 ma.

The sensitivity of good-quality double-button microphones is considerably less, ranging from 0.025 volt to 0.07 volt across 200 ohms. With this type microphone, and the usual push-pull input transformers, a peak voltage of 0.4 to 0.5 volt across 100,000 ohms or

characteristic is unaffected by capacitance of the connecting cable, since the crystal element has a relatively large capacitive reactance to start with. The load resistance (amplifier grid resistor) does affect the frequency characteristic, however, the lower frequencies being attenuated as the shunt resistance becomes less. Grid resistor values of 1 megohm and higher should be used. Increased series resistance attenuates the higher frequencies, tending to raise the low-frequency response.

# The Radio Amateur's Handbook . . . . .

## RESISTANCE-COUPLED VOLTAGE AMPLIFIER DATA

Type Tube	Element Connection	Plate Supply Volts	Plate Load Resistance	Grid Bias Volts or Cathode Res.	Screen Volts	Approx. Voltage Amp.	Approx. Peak Voltage Output
57, 6C6, or 6J7	Pentode	250	250,000 ohms	3500 ohms	50	100	65 V.
Same	Triode (Screen tied to plate)	250	50,000 ohms	2200 ohms	—	14	65 V.
79	Cascade Triode (2-stage amp.)	250	250,000 ohms	2 V.	—	2100 (for both sections)	65 V.
53, 6A6, 6N7	Cascade Triode (2-stage amp.)	250	250,000 ohms	3 V.	—	720 (for both sections)	58 V.

## CLASS-A MODULATOR DATA \*

Type Tube	Fil. Volts, $E_f$	Plate Volts, $E_b$	Plate Ma., $I_b$	Neg. Grid Volts, <sup>1</sup> $E_c$	Load Imp., <sup>2</sup> Ohms	Audio Output, <sup>3</sup> Watts
211, 242A, 276A	10.0	1000	65	52	7000	10.0
845	10.0	1000	75	150	7500	23.0
284A	10.0	1250	60	228	10,000	41.5
849	11.0	2000 2500 3000	125 110 100	75 104 132	12,000 12,000 20,000	42.5 81.0 100.0

\* For data on receiving type tubes (2A3, 6L6, etc.), see tube tables of Chapter Five.

With exception noted, ratings are for a single tube. For tubes in parallel multiply  $I_b$  and Output Watts by number used, and divide Load Impedance by number used. For 2 tubes in push-pull, multiply  $I_b$ , Load Impedance and Output Watts by 2, taking peak audio grid voltage twice bias value.

<sup>1</sup> Peak audio grid voltage equal to bias value for single tube or tubes in parallel.

<sup>2, 3</sup> To be used in determining Class-C amplifier operating conditions by method described in text.

<sup>4</sup> Two tubes in push-pull. Peak audio grid voltage twice bias value.

### Speech Amplifier Considerations

● The speech amplifier of the 'phone transmitter includes the audio stages between the microphone and the grid circuit of a Class-A modulator or the grid circuit of the Class-A power driver stage for a Class-B modulator.

Knowing the approximate value of voltage output obtainable from the microphone and the voltage excitation requirement of the Class-A modulator or driver stage, the total voltage amplification necessary can be estimated. The voltage swing required by the Class-A power stage will be approximately equal to its grid bias in the case of a single tube or tubes in parallel, and approximately twice the bias value for tubes in push-pull. The approximate voltage gain required of the speech amplifier therefore will be the ratio of this max-

imum grid swing to the peak voltage across the microphone. This gain will include amplification of the tubes and step-up in coupling devices such as transformers. The method is illustrated by the skeleton diagram of Fig. 1108. The voltage step-up in a coupling transformer is assumed the same as its turns ratio, while the approximate gain of a tube is taken as 60 or 65 per cent of its rated amplification factor ( $\mu$ ) in the case of a triode, and about 10 per cent in the case of a screen-grid (pentode) tube. The combination chosen should show a calculated maximum gain of 50 to 100 per cent greater than will actually be required, to allow for reserve, the excess being compensated for in operation by adjustment of the volume or gain control. Voltage amplifier data for popular combinations are given in the table.

# Fundamentals of Radiotelephony

TABLE II—CLASS-B MODULATOR DATA

Class-B Tubes (2)	Fil. Volts	Plate Volts	Grid Volts App.	Peak A.F. Grid-to-Grid Voltage	Zero-Sig. <sup>1</sup> Plate Current Ma.	Max.-Sig. <sup>1</sup> Plate Current Ma. <sup>2</sup>	Load Res. Plate-to-Plate Ohms	Max.-Sig. Driving Power Watts <sup>3</sup>	Max.-Sig. <sup>1</sup> Power Output Watts <sup>3</sup>
10	7.5	350 425	-40 -50	120 130	8 8	110 110	6000 8000	2.3 2.5	20 25
841	7.5	350 425	-5 -5	— —	7 13	114 120	5200 7000	Note 4	21 28
801	7.5	400 500 600	-50 -60 -75	270 290 320	8 8 8	130 130 130	6000 8000 10,000	3 3 3	27 36 45
825	7.5	850	-67.5	—	50	170	8000	Note 4	82
RK18	7.5	750 1000	-40 -50	180 198	— —	153 172	10,000 12,000	Note 4	65 100
756	7.5	850	-30	—	20	225	6750	Note 4	100
800	7.5	750 1000 1250	-40 -55 -70	— — —	26 28 30	210 160 130	6400 12,500 21,000	Note 5	90 100 106
RK31	7.5	1250	0	—	—	170	13,000	Note 4	125
35T	5.0	750 1000 1250 1500	-25 -35 -45 -50	— — — —	— — — —	200 185 156 140	7000 11,200 17,200 23,600	8 7 5.5 4.5	90 115 125 135
830-B	10.0	800 1000	-27 -35	250 270	20 20	280 280	6000 7600	5 6	135 175
203-B	10.0	1000	-35	—	40	330	6800	Note 5	200
50T	5.0	1000 1500 2000 3000	-85 -135 -180 -280	— — — —	— — — —	200 166 146 115	6000 9600 12,000 16,000	4.5 4.5 4.5 4.5	100 155 195 250
154	5.0	750 1000 1250 1500	— — — —	— — — —	— — — —	Tentative Ratings		10 10 10 10	150 200 225 250
203-A	10.0	1000 1250	-35 -45	— —	26 26	320 320	6900 9000	Note 5	200 260
838	10.0	1000 1250	0 0	90 90	106 148	320 320	7600 11,200	5 5	200 260
852	10.0	2000 3000	-150 -250	— —	22 14	180 160	22,000 36,000	Note 6	220 360
805	10.0	1250 1500	0 -16	235 280	148 84	400 400	6700 8200	6 7	300 370
822	10.0	2000	-90	—	50	450	9000	Note 7	500
HD 203-A	10.0	1500 1750	-40 -67	— —	36 36	425 425	8000 9000	Note 6	400 500
204-A	11.0	1500 2000	-40 -60	— —	74 74	500 500	7800 8800	Note 7	400 600
150T	5.25	1000 1500 2000 2500	-80 -130 -170 -220	— — — —	— — — —	400 400 400 370	4000 6800 11,000 14,800	11 14 16 16	200 350 490 610
354	5.0	1000 1500 2000 2500	-60 -100 -150 -180	— — — —	20 20 20 20	160 240 320 345	15,000 15,000 15,000 18,000	5.6 11 21 26	100 220 400 560

<sup>1</sup> Values are for both tubes.  
<sup>2</sup> Sinusoidal signal values; speech values are approximately one-half for tubes biased to approximate cut-off and 80% for zero-bias tubes.  
<sup>3</sup> Values do not include transformer losses. Somewhat higher power is required of the driver to supply losses and provide good regulation.  
<sup>4</sup> Can be driven by a pair of 45's in push-pull at 250 volts.  
<sup>5</sup> Can be driven by a pair of 2A3's in push-pull at 250 volts.  
<sup>6</sup> Can be driven by a pair of 2A3's in push-pull Class-AB at 300 volts with fixed bias.  
<sup>7</sup> Can be driven by four 2A3's in push-pull parallel Class-AB or by a pair of 6L6's.  
 Input transformers must be designed to fit particular driver-Class-B Amplifier combinations. Suitable transformers are available from various manufacturers.

# 12

## ***Building Radiotelephone Transmitters***

### **CONSTRUCTION OF TYPICAL AUDIO SECTIONS AND ADJUSTMENT FOR PROPER MODULATION**

**T**HE general design principles outlined in the previous chapter serve as the basis for an almost infinite variety of transmitter combinations. Descriptions of every possible arrangement that might be used for amateur 'phone would fill a book even larger than this one. A group of established types, which includes the combinations most generally adapted to amateur use, with r.f. sections for both the high- and ultra-high frequency 'phone bands as described in Chapters Nine and Fourteen, will be described as examples. No one combination need be duplicated in its entirety, of course. The speech input circuits may be interchanged to suit the microphone and tubes available, other styles of assembly can be adopted, power tubes of equivalent capability can be substituted. To facilitate individual choice, Class-A and Class-B audio data are given in the tables, as are also voltage amplifier data. Data for r.f. tubes in grid-bias and suppressor modulated stages, and for Class-B linear amplifier service, are given in the tube tables of Chapter Five. With all this information, an amateur trans-

mitter of almost any conceivable type can be built up.

#### **What Type Transmitter?**

● Transmitters are usually distinguished by the method of modulation they use — Class-A plate, Class-B plate, grid-bias or control-grid, or any one of these with Class-B linear amplification and perhaps with controlled-carrier operation. Each has its enthusiastic supporters, and all technically will give equivalent results. The choice is mostly a matter of first cost, which will depend somewhat on the equipment already available. Transmitters of 100-watt or so r.f. output usually can be most economically adapted to Class-B plate modulation, which gives the most watts per dollar. Higher-power r.f. units may be readily adapted to grid-bias modulation at relatively small cost, although the 'phone output will be necessarily reduced to about a quarter of the c.w. code capability. With a power pentode final stage, suppressor-grid modulation is easily applied, with practically the same requirement of reduced output as with grid-bias modula-

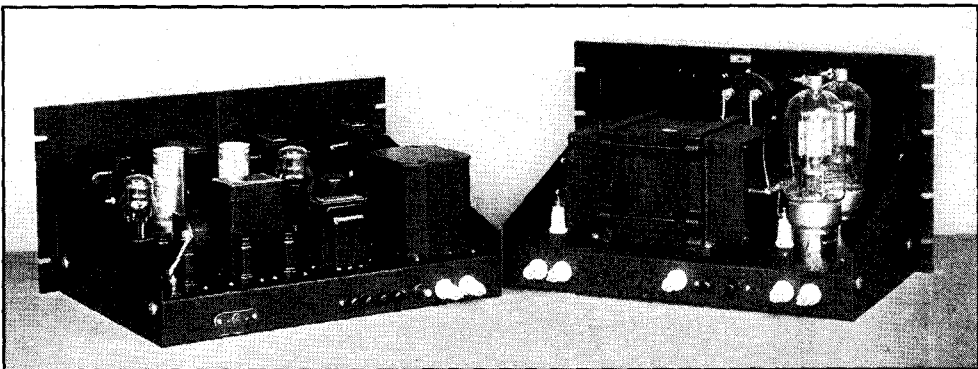

**FIG. 1201 — SPEECH-AMPLIFIER AND 50-WATT DRIVER UNIT (LEFT) AND 500-WATT CLASS-B MODULATOR (RIGHT) REPRESENTING MODERN AMATEUR PRACTICE. THE CIRCUITS ARE DESCRIBED IN THIS CHAPTER**

# . . . . Building Radiotelephone Transmitters

tion. Plate modulation might be added later to give full 'phone output, employing the grid modulator in a driver unit for the Class-B modulator. High-level plate and suppressor-grid modulation systems are the most tolerant in adjustment and maintenance. Grid-bias modulation is somewhat more complicated, as is also the Class-B linear stage with low-level modulation. The Class-B linear is used by amateurs to only a limited extent.

## General Construction Practice

● Audio units for simple transmitters can be built up bread-board style, although a metal

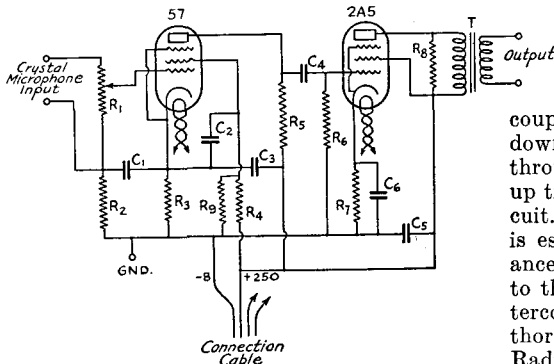

**FIG. 1202—CIRCUIT OF A SIMPLE SPEECH-AMPLIFIER AND MODULATOR SUITABLE FOR LOW-POWER PLATE MODULATION, OR FOR SUPPRESSOR- OR CONTROL-GRID MODULATION**

- $C_1$  — .1  $\mu$ fd.
- $C_2, C_3, C_5$  — 2- $\mu$ fd. electrolytic, 450-volt rating.
- $C_4$  — .1  $\mu$ fd., 500-volt rating.
- $C_6$  — 10  $\mu$ fd., 50-volt rating.
- $R_1$  — 500,000-ohm potentiometer.
- $R_2$  — 100,000 ohms,  $\frac{1}{2}$  watt.
- $R_3$  — 3500 ohms,  $\frac{1}{2}$  watt.
- $R_4$  — 100,000 ohms,  $\frac{1}{2}$  watt.
- $R_5$  — 250,000 ohms,  $\frac{1}{2}$  watt.
- $R_6$  — 500,000 ohms,  $\frac{1}{2}$  watt.
- $R_7$  — 400 ohms, 2 watt.
- $R_8$  — 7500 ohms, 5 watt.
- $R_9$  — 50,000 ohms,  $\frac{1}{2}$  watt.
- $T$  — Class-B input transformer, ratio approximately 1:1.

A power supply furnishing 2.5 volts at 3 amperes and 180 to 250 volts at 40 milliamperes is required.

chassis foundation is preferable for a permanent job. Present practice tends toward unit construction on metal chassis, with rack mounting. Foundation bases of the type used for modern receivers are admirably suited. Shielding is important where high-gain audio systems are used, it being especially important to keep r.f. from overloading the low-level grid circuits. When two or more stages of speech amplification are used, particular care must be taken to prevent motorboating and distortion resulting from inter-stage feed-back. Coupling

transformers should be isolated from each other or placed for minimum reaction between their magnetic fields. Proper positions can be determined by turning the transformers, one with respect to the others, until minimum hum or instability is obtained with the unit in operation at full gain. It is advisable to keep modulation chokes and transformers well away from other audio equipment because the strong magnetic field about the high-level audio unit is likely to cause trouble. Transformer cases should be grounded to the negative side of the circuit.

Microphone cables should be shielded and the shield connected to ground. It is generally good practice to shield the high-gain input circuit separately and keep it away from the high-level audio and r.f. sections of the transmitter. It is well to couple a speech-input amplifier by a step-down transformer (tube-to-line) in its output, through a twisted-pair to a line-to-tube step-up transformer into the higher-level audio circuit. Such an impedance matching combination is especially recommended with high-impedance microphones which require short leads to the first audio stage or pre-amplifier. Interconnecting leads and cables should be thoroughly shielded and the shields grounded. Radio-frequency chokes may be necessary between modulator and modulated amplifier in high-voltage supply leads.

A.c. filament and power-pack high-voltage supplies may be used for all stages, although more than ordinary filtering should be used for high-gain amplifiers. Filtering or decoupling in individual plate- and grid-feed circuits is advisable, as illustrated in the high-gain circuits which will be described.

## Modulator Combinations

● Class-A and Class-AB modulators using receiving type tubes for grid-bias and suppressor-grid modulation in medium- and high-power transmitters, and for plate modulation in low-power transmitters, are essentially the same as the drivers for Class-B modulators which are described in the following pages and therefore require no special description. (See tables in Chapter Five for ratings.) They will differ only in the output transformer impedance ratio, which should be chosen to match the load impedance requirement of the particular audio tubes used to the modulating impedance of the r.f. stage. In the case of grid-bias or suppressor-grid modulation, the output may have a "dummy" load resistance connected across it to maintain the modulator load resistance practically constant, as shown later

# The Radio Amateur's Handbook . . . . .

in several examples. Higher-power Class-A and Class-AB modulators are planned readily for the larger audio output tubes from the data given in the Class-A modulator table.

One of the simplest low-power modulator or driver arrangements, capable of approximately 3-watt maximum output, is diagrammed in Fig. 1202. This unit is especially intended for grid-bias modulation of the general-purpose transmitter described in Chapter Nine, with the final stage bias circuit revised as shown later in Fig. 1219. It is also readily adaptable to suppressor-grid modulation of pentode stages using RK-20's, 803's, and similar tubes. It can be used as well to plate-

modulate a low-power Class-C stage operating at about 5-watt or so input, in which case the loading resistor  $R_8$  would be omitted.

### A General-Purpose 18-Watt Audio Unit

● Fig. 1203 gives the circuit and specifications of a general-purpose audio unit having many applications. It can be used as a grid-bias or suppressor modulator for any size amateur transmitter, or as the driver for Class-B modulators using tubes including 203-A's, 838's and other types in the 100-watt classification. The input circuit is adapted to either crystal or double-button carbon microphones, a resistance-coupling network being used with the

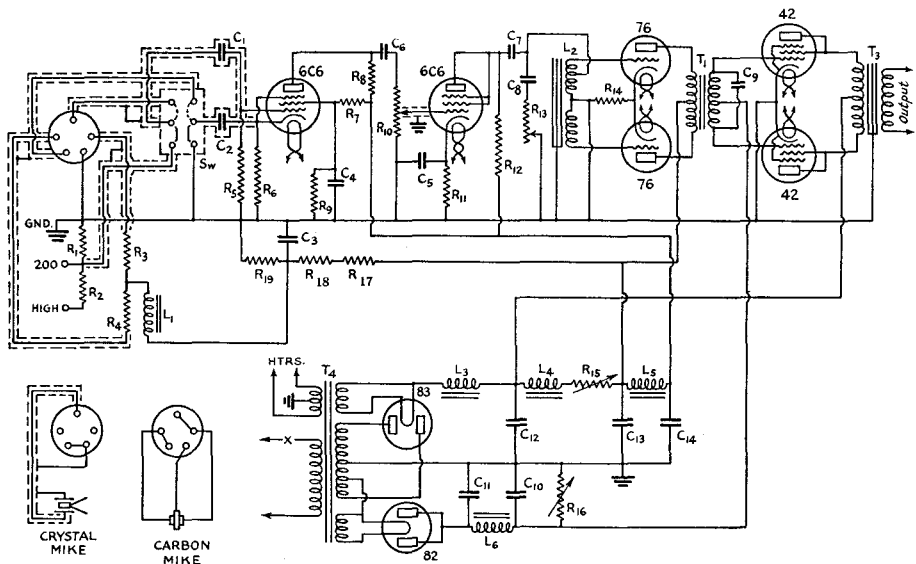

FIG. 1203 — CIRCUIT OF THE GENERAL-PURPOSE 18-WATT AUDIO UNIT

This general-purpose unit, with its audio output of 18 watts and high overall gain, is capable of driving a high-power Class-B modulator or can be used for public-address work.

- $C_1$  — 0.1- $\mu$ fd. 400-volt metal-cased.
  - $C_2, C_3$  — 25- $\mu$ fd. 25-volt electrolytic.
  - $C_4$  — 8- $\mu$ fd. 200-volt electrolytic.
  - $C_5$  — 25- $\mu$ fd. 25-volt electrolytic.
  - $C_6, C_7$  — 0.1- $\mu$ fd. 400-volt tubular.
  - $C_8$  — .003- $\mu$ fd. 400-volt tubular.
  - $C_9$  — .001- $\mu$ fd. 600-volt tubular.
  - $C_{10}, C_{11}$  — 8- $\mu$ fd. 200-volt electrolytic.
  - $C_{12}, C_{13}, C_{14}$  — 8- $\mu$ fd. 450-volt electrolytic.
  - $R_1$  — 200 ohms, 1-watt.  $R_9$  — 20,000 ohms, 1-watt.
  - $R_2$  — 10,000 ohms, 1-watt.  $R_{10}$  — 0.25-megohm volume control.
  - $R_3, R_4$  — 200 ohms, 1-watt.
  - $R_5$  — 5 megohms, 1-watt.  $R_{11}$  — 2200 ohms, 1-watt.
  - $R_6$  — 2200 ohms, 1-watt.  $R_{12}$  — 50,000 ohms, 1-watt.
  - $R_7$  — 0.1 megohm, 1-watt.  $R_{13}$  — 0.25-megohm variable (tone control).
  - $R_8$  — 0.25 megohm, 1-watt.
- Important — The power supply components shown in this list will furnish 25 watts of field power for dynamic speakers. In case no speakers are used, a 5000-ohm, 50-watt resistor must be connected across the high-voltage output.

- $R_{14}$  — 1500 ohms, 1-watt.
- $R_{15}$  — 10,000-ohm semi-variable, 30-watt.
- $R_{16}$  — 1500-ohm semi-variable, 30-watt.
- $R_{17}, R_{18}$  — 5000 ohms, 10-watt.
- $R_{19}$  — 1250 ohms, 1-watt.
- $L_1$  — 7.2 henrys, 120 ma. (Thordarson T-5319).
- $L_2$  — Push-pull input transformer connected as shown (Thordarson T-7431).
- $L_3$  — 10-30 henry swinging choke, 150 ma. (Thordarson T-7429).
- $L_4$  — 22 henrys, 35 ma. (Thordarson T-1892).
- $L_5$  — 42 henrys, 15 ma. (Thordarson T-7430).
- $L_6$  — 7.2 henrys, 120 ma. (Thordarson T-7549).
- $T_1$  — Push-pull input transformer, 800-ohm secondary, ratio 1.5 to 1, total primary to total secondary (Thordarson T-7432).
- $T_2$  — Power transformer, 450 volts at 150 ma. with tap at 75 volts, 6.3-volt, 5-volt and 2.5-volt filament windings (Thordarson T-7428).
- $T_3$  — Output transformer, depending on load to which amplifier is to be coupled.

# . . . . Building Radiotelephone Transmitters

latter to avoid hum pick-up and, at the same time, to bring the amplifier input down to approximately the same level as that obtained with the less sensitive crystal type. A dual power supply, integral with the amplifier, takes care of amplifier plate requirements

## 50-Watt 6L6 Modulator Or High-Power Class-B Driver

● The 6L6 speech-amplifier unit shown in Fig. 1204 is also a general purpose affair, in that substitution of a suitable output transformer

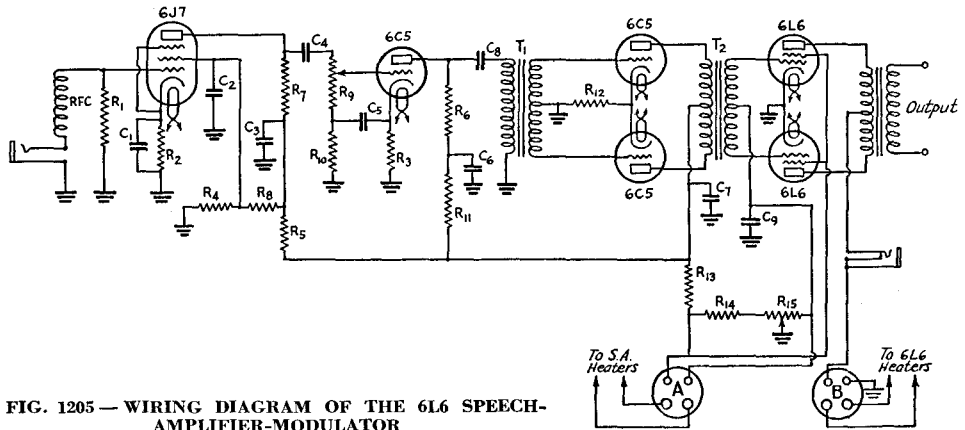

FIG. 1205 — WIRING DIAGRAM OF THE 6L6 SPEECH-AMPLIFIER-MODULATOR

$C_1$  — 10- $\mu$ d., 25-volt electrolytic.  
 $C_2, C_3$  — 2- $\mu$ d., 200-volt electrolytic.  
 $C_4$  — 0.1- $\mu$ d. paper, 400-volt.  
 $C_5$  — 0.5- $\mu$ d. paper (or larger).  
 $C_6, C_7$  — 4- $\mu$ d., 400-volt electrolytic.  
 $C_8$  — 0.25- $\mu$ d. paper, 400-volt.  
 $C_9$  — 25- $\mu$ d. electrolytic, 50-volt.  
 $R_1$  — 5 megohms,  $\frac{1}{2}$  watt.  
 $R_2, R_3$  — 3500 ohms,  $\frac{1}{2}$  watt.

$R_4, R_5, R_6$  — 50,000 ohms,  $\frac{1}{2}$  watt.  
 $R_7, R_8$  — 0.25 megohm,  $\frac{1}{2}$  watt.  
 $R_9$  — 0.5-megohm volume control.  
 $R_{10}$  — 100,000 ohms,  $\frac{1}{2}$  watt.  
 $R_{11}$  — 10,000 ohms,  $\frac{1}{2}$  watt.  
 $R_{12}$  — 500 ohms,  $\frac{1}{2}$  watt.  
 $R_{13}$  — 2500 ohms, 1 watt.  
 $R_{14}$  — 15,000 ohms, 10-watt.  
 $R_{15}$  — 1000 ohms, 10-watt.

$T_1$  — Audio transformer, single plate to push-pull grids, ratio 3:1 (Thordarson T-5741).  
 $T_2$  — Input transformer for coupling push-pull 6C5's to 6L6 grids (Thordarson T-8459).  
 $T_3$  — Output transformer, 3800-ohm load plate to plate, see text (Thordarson T-8470).

and furnishes bias to the Class-AB final stage. The design of this unit was described in detail in Jan. 1936 *QST* by W9GSA and W9UVP.

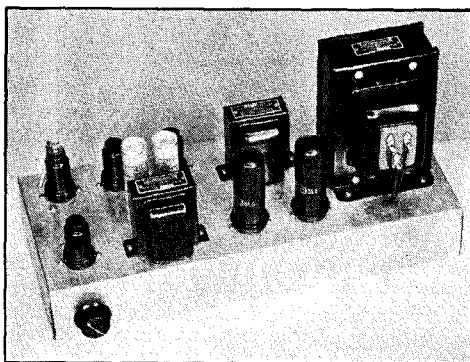

FIG. 1204 — METAL-TUBE SPEECH UNIT WITH PUSH-PULL 6L6 OUTPUT

This four-stage amplifier will deliver an audio output of approximately 50 watts with negligible distortion. The gain is sufficient for the popular diaphragm-type crystal microphone.

makes it adaptable either as a complete modulator or as a driver for Class-B units employing anything up to a pair of 354's or 204-A's. The voltage gain to the grids of the 6L6's is more than sufficient for crystal microphones of the diaphragm type, a peak input of about 0.005 volt being sufficient to drive the final tubes to full output. As shown in Fig. 1205, the input stage uses a 6J7 (equivalent to the 57 or 6C6) pentode; this tube is resistance-coupled to a 6C5 triode intermediate amplifier. The driver consists of a pair of 6C5's in push-pull, transformer-coupled to the preceding stage. The 6C5's are capable of delivering sufficient power for excitation of the 6L6 grids. The input transformer,  $T_2$ , is specially designed for the purpose. The 6L6 output transformer,  $T_3$ , also is a special job, arranged with a tapped secondary to work into loads of 2500, 5000 or 7500 ohms for modulation purposes; its turns ratio is such that the plate-to-plate load on the 6L6's is 3800 ohms.

The low-level speech-amplifier section occupies the left-hand section of the chassis. The design of the whole unit is perfectly straightforward. The microphone jack is on the back of

# The Radio Amateur's Handbook . . . . .

the chassis near the 6J7 tube; the first 6C5 is at the front left-hand corner, with the gain control conveniently situated. To its right is the single-tube to push-pull coupling transformer; back of the coupling transformer are two

the 300-volt supply. Reference to Fig. 1206 will show that there is no ground on the negative side of the 300-volt supply (outlet A). The total current from this supply is made to flow

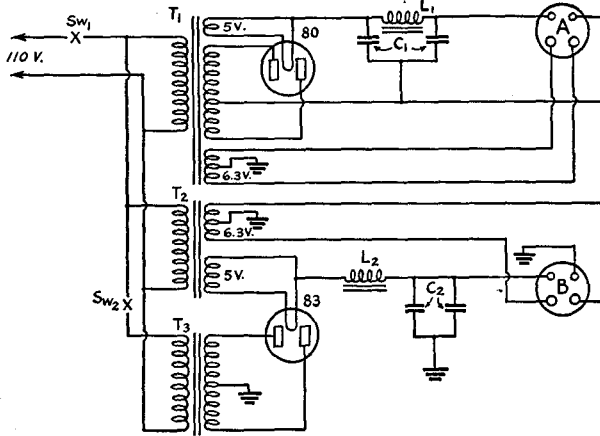

FIG. 1206 — DIAGRAM OF THE 6L6 POWER-SUPPLY UNIT

- T<sub>1</sub> — Receiver power transformer; high-voltage winding to deliver app. 325 volts d.c. at 50 ma.; 5-volt, 2-amp. rectifier winding; 6.3-volt, 1.5-amp. filament winding (Thordarson T-7073).
- T<sub>2</sub> — Filament transformer, 5 volts at 3 amps., 6.3 volts at 2 amps. (Thordarson T-7984).
- T<sub>3</sub> — Plate transformer, to deliver 400 volts at 100 ma. through choke-input filter (Thordarson T-5503).
- L<sub>1</sub> — 50-ma. filter choke, 30-henry commercial rating.
- L<sub>2</sub> — Input choke, 26 to 12 henrys, 250 ma. (Thordarson T-7551).
- C<sub>1</sub>, C<sub>2</sub> — Double 8-μfd. dry electrolytics, 450-volt.
- SW<sub>1</sub>, SW<sub>2</sub> — S.p.s.t. toggle switch.

electrolytic by-passes, C<sub>6</sub> and C<sub>7</sub>, followed by the push-pull 6C5's. The input and output transformers, as well as the 6L6's, are readily identified. The jack for measuring 6L6 plate current is mounted on the back of the chassis, along with a stock two-terminal strip for the output.

Two power supplies are used, one furnishing 400 volts at 100 to 200 ma. for the 6L6 plates and the other (rated to deliver 300 volts) furnishing plate power to the low-level stages as well as screen voltage and grid bias for the 6L6's. The circuit is shown in Fig. 1206. All tubes except the 6L6's get filament power from the first transformer, T<sub>1</sub>. A separate filament transformer, T<sub>2</sub>, takes care of the 6L6's and the 83 rectifier of the 400-volt supply. An ordinary condenser-input filter with one choke (this choke is mounted underneath the power-supply chassis) is used on the 300-volt supply. The 400-volt supply has choke input, with the two sections of a double-8 electrolytic condenser in parallel across the output.

The fixed bias for the 6L6's is obtained from

the adjustable tap on R<sub>15</sub> (Fig. 1205) to ground; by means of the adjustable tap on R<sub>15</sub> the bias voltage is set at 25 volts. R<sub>14</sub> is a bleeder resistor to load the 300-volt transformer to full capacity. It is desirable to do this so that the current through R<sub>15</sub> will be as heavy as possible, thus maintaining the bias fairly constant even though grid current flows. R<sub>13</sub> drops the voltage to the proper value for the speech-amplifier plates.

The power terminals on both speech and power-supply units are four-prong tube sockets. Connections are made by means of four-wire cables with plugs at each end.

A few words about operation: Provided the values given are followed, the only adjustment to be made is that of the bias on the 6L6's. Preferably, this should be done with the aid of a high-resistance voltmeter, with everything except the 400-volt plate transformer turned on. However, if no such voltmeter is available, a method which works about as well is to set the tap on R<sub>15</sub> so that the plate current to the 6L6's is slightly over 100ma. It is essential that the screen voltage be exactly 300 volts, since the plate current is quite sensitive to changes in screen voltage.

With the values given in the circuit diagrams, the whole system is perfectly stable (a ground connection must be used, of course) and the hum level is negligible. Should the hum increase perceptibly when the microphone plug is inserted, it will be necessary to shield the grid cap of the 6J7. (See June 1936 QST for a more detailed description.)

The same circuit is used in the unit at the left in Fig. 1201, in which both amplifier and power supply are built on the same chassis for 19-inch rack mounting. All components are as given in Fig. 1205 except for the transformers T<sub>2</sub> and T<sub>3</sub>. To minimize power-supply hum in the unit assembly a balanced type coupling transformer is used for T<sub>2</sub> (Thordarson T-9004), and a Class-B input transformer for coupling 6L6's to 354's (UTC Type 18126) is used for T<sub>3</sub>.



# . . . Building Radiotelephone Transmitters

## Economy Modulator for 50-Watt Transmitters

● The modulator illustrated in Fig. 1207 and diagrammed in Fig. 1208 is intended especially for speech modulation of a Class-C amplifier operating with a plate input of 140 ma. at 600 volts (approximately 85 watts). Although the modulator tubes have a normal output rating of only 20 or 25 watts, 100 per cent speech modulation of this Class-C input is obtained with negligible distortion, following the principles outlined in the preceding chapter. This

**FIG. 1207 — THE ECONOMY MODULATOR UNIT CONTAINS A CRYSTAL-MICROPHONE SPEECH AMPLIFIER, DRIVER AND CLASS-B MODULATOR, AS WELL AS A POWER SUPPLY FOR THE LOW-POWER STAGES**

While the 46's in the Class-B stage normally would be considered to have an audio output in the vicinity of 20 watts, for speech work they can readily be made to modulate a Class-C input of 80 watts, as explained in the text.

is accomplished by operating the modulator at slightly higher than usual plate voltage and by

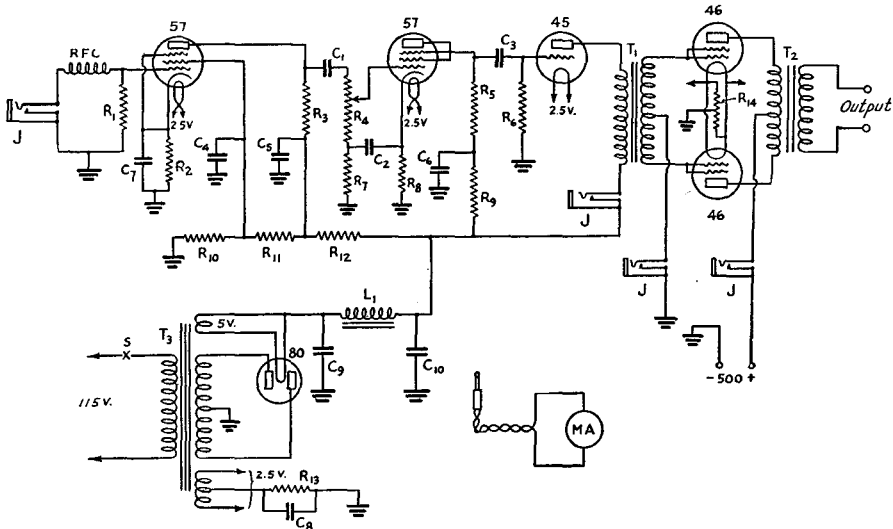
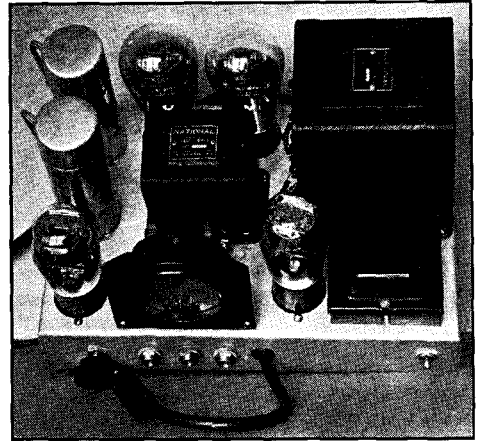

**FIG. 1208 — CIRCUIT DIAGRAM OF THE SPEECH AMPLIFIER AND ECONOMY CLASS-B MODULATOR**

The power supply furnishes plate and filament power for the first three tubes only; the Class-B stage must be supplied from a separate source. If a power transformer having an additional 2.5-volt winding is used, filaments of the 46's may be heated from the second winding.

- |   |  |
|---|--|
| R <sub>1</sub> — 5 megohms, ½ watt.           | C <sub>1</sub> — 0.1 μfd., 400-volt.   |
| R <sub>2</sub> — 3500 ohms, ½ watt.           | C <sub>2</sub> — 0.1 μfd.  |
| R <sub>3</sub> — 250,000 ohms, ½ watt.        | C <sub>3</sub> — 0.1 μfd., 400-volt.   |
| R <sub>4</sub> — 500,000-ohm volume control.  | C <sub>4</sub> , C <sub>5</sub> , C <sub>6</sub> — 2-μfd. electrolytic, 400-volt.  |
| R <sub>5</sub> — 50,000 ohms, 1 watt.         | C <sub>7</sub> , C <sub>8</sub> — 10-μfd. electrolytic, 25-volt.   |
| R <sub>6</sub> — 0.5 megohm, ½ watt.          | C <sub>9</sub> , C <sub>10</sub> — 8-μfd., electrolytic, 400-volt.   |
| R <sub>7</sub> — 0.1 megohm, ½ watt.          | T <sub>1</sub> , T <sub>2</sub> — Class-B input and output transformers; (National Type BI and BO respectively). The input transformer should have a turns ratio, total primary to one-half secondary, |
| R <sub>8</sub> — 2250 ohms, 1 watt.           |  |
| R <sub>9</sub> — 10,000 ohms, 1 watt.         |  |
| R <sub>10</sub> — 50,000 ohms, ½ watt.        |  |
| R <sub>11</sub> — 250,000 ohms, ½ watt.       |  |
| R <sub>12</sub> — 50,000 ohms, ½ watt.        |  |
| R <sub>13</sub> — 1500 ohms, 2 watt.          |  |
| R <sub>14</sub> — 20-ohm center-tap resistor. |  |

- of 2:1. Output transformer turns ratio should be between 1.05:1 and 1.3:1, total primary to total secondary.
- T<sub>3</sub> — Midget power transformer, 275 volts each side center-tap with 5-volt and 2.5-volt windings. (Thordarson type T-5002.)
- L — 22-henry, 35-ma. filter choke (Thordarson type T-1892).
- J — Single closed-circuit jacks.
- MA — 0-200 d.c. milliammeter.
- RFC — Short-wave choke (National type 100).

# The Radio Amateur's Handbook . . . . .

proper output transformer ratio (total primary to total secondary turns ratio of 1.15-1). The driver stage requirement of 50 volts peak grid swing is easily delivered by the two-stage speech amplifier with crystal microphone input. The total voltage amplification for the two stages is approximately 1400, adequate for close talking.

The complete assembly is built up on a chassis measuring 7 by 11 by 2 inches. The first-stage 57 is at the rear left corner; midway on the left-hand edge is the second 57 (triode connected) with the 45 driver at the left front. The Class-B input transformer is behind the meter panel, with the 46 modulator tube directly behind. The Class-B output transformer is in the rear right corner, the power transformer for the speech-amplifier and driver stages being at the front, beside the 80 rectifier. With the transformers placed as shown, hum pick-up at the input is imperceptible, although different orientation of the power transformer with respect to the output transformer brings the hum up considerably. In a compact as-

sembly of this type, the location of the respective transformers for minimum hum can be checked readily by listening with a pair of 'phones connected to one of the audio transformer windings while moving the transformers about slightly with the amplifier in operation. The small filter, in conjunction with the resistance-capacitance filtering of  $R_{12}$  and  $C_5$ , is satisfactory. It is especially important in the first stage that the screen voltage be maintained at the proper value. The voltage divider  $R_{10}$ - $R_{11}$  serves this purpose. Particular care should be taken to see that the screen voltage is not too high, since this will reduce gain, cause distortion and may even give rise to super-sonic oscillation.

With speech modulation of the Class-C amplifier input specified, the plate current should swing no higher than approximately 80 ma. on speech peaks. Class-B grid current should be between 10 and 20 ma. under corresponding conditions. The Class-C plate current should remain constant, of course. Because of the different voltages on the Class-B

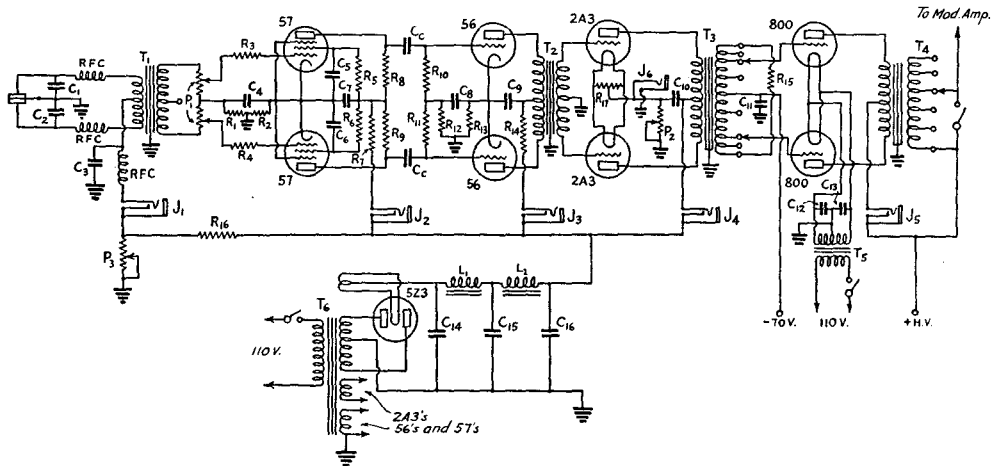

FIG. 1209 — CIRCUIT OF THE 100-WATT AUDIO SECTION

- $C_1, C_2$  — .001  $\mu$ f.
- $C_3$  — 25- $\mu$ f., 25-volt electrolytic.
- $C_4, C_5, C_6$  — .1  $\mu$ f.
- $C_7$  — 8- $\mu$ f. electrolytic.
- $C_8$  — .1  $\mu$ f.
- $C_9, C_{10}$  — 8- $\mu$ f. electrolytic.
- $C_{11}, C_{12}, C_{13}$  — .1  $\mu$ f.
- $C_{14}, C_{15}, C_{16}$  — 8- $\mu$ f. electrolytics, 500-volt.
- $C$  — .01  $\mu$ f. mica condensers.
- $R_1$  — 100,000 ohms, 1-watt.
- $R_2$  — 1500 ohms, 2-watt.
- $R_3, R_4$  — 50,000 ohms, 1-watt.
- $R_5, R_6$  — 200,000 ohms, 1-watt.
- $R_7$  — 10,000 ohms, 2-watt.
- $R_8, R_9$  — 200,000 ohms, 1-watt.
- $R_{10}, R_{11}$  — 500,000 ohms, 1-watt.
- $R_{12}$  — 100,000 ohms, 1-watt.

- $R_{13}$  — 1500 ohms, 2-watt.
- $R_{14}$  — 3000 ohms, 5-watt.
- $R_{15}$  — 40,000 ohms, 2-watt.
- $R_{16}$  — 50,000 ohms, 2-watt.
- $P_1$  — 250,000-ohm (each section) dual potentiometer.
- $P_2$  — 500-ohm, 10-watt potentiometer.
- $P_3$  — 1000-ohm, 2-watt potentiometer.
- $J_1$  to  $J_5$ , inc. — Single circuit-closing jacks.
- $J_6$  — Open-circuit jack.
- $T_1$  — Microphone transformer (W.E.).
- $T_2$  — Audio transformer, 1:3 ratio.
- $T_3$  — Class-B input transformer.
- $T_4$  — Class-B output transformer.
- $T_5$  — 7.5-volt filament transformer.
- $T_6$  — Power transformer, 250 watts, 600 volts c.t.
- RFC — 8-mh. r.f. chokes.

# . . . Building Radiotelephone Transmitters

and Class-C stages, separate power packs of good regulation are advisable.

## A 100-Watt All Push-Pull Audio Section

● The speech-amplifier and modulator unit diagrammed in Fig. 1209 has an audio output capability of 100 watts with double-button carbon microphone input. It employs a number of features to minimize distortion, including push-pull speech amplification. It is designed for use with a Class-C amplifier using 1000-volt tubes, such as a pair of 800's or RK-18's in parallel or push-pull, or a single 100-watt type. By careful adjustment, with speech modulation it also can be used to modulate still higher Class-C input than the usual 200 watts, having been used successfully by its designer (W4UP) to modulate a pair of 261-A tubes in push-pull operating at a plate input of 300 watts (230 ma. at 1300 volts).

As in the smaller unit just described, although a compact assembly is used hum and feed-back are eliminated by careful placement of the components and shielding. Tube shields are used on the input stage and copper braid shields the grid-leads, while resistors such as  $R_1$  and  $R_2$ ,  $R_3$  and  $R_4$ ,  $R_{12}$  and  $R_{13}$ ,  $R_8$  and  $R_9$ ,

etc., are paired in individual shield cans with braid covering the entering wires. All these precautions may not be necessary, but they contribute to the over-all stability and distortionless operation that can be attained.

Adjusting taps are shown on the Class-B input and output transformers, although standard types with single pairs of connecting terminals can be used as well. The chassis of the unit is built up on strips of  $\frac{3}{4}$ -by 2-inch plywood stock, the top being covered by a piece of 16-gauge aluminum. Battery bias is used for the Class-B modulator stage. The plate power supply should have good regulation (swinging-choke input filter) and be capable of delivering 200 to 250 ma. at 1250 volts to obtain the specified performance. For normal operation, the plate current should kick to a maximum of approximately 100 ma. at 100-per cent modulation.

## A 250-Watt High-Gain Class-B Unit

● A popular type of modulator in higher-power amateur stations uses a Class-B stage employing 203-A's or 838's. This modulator is suitable for a Class-C stage using either 1000- or 2000-volt tubes of the 100-watt

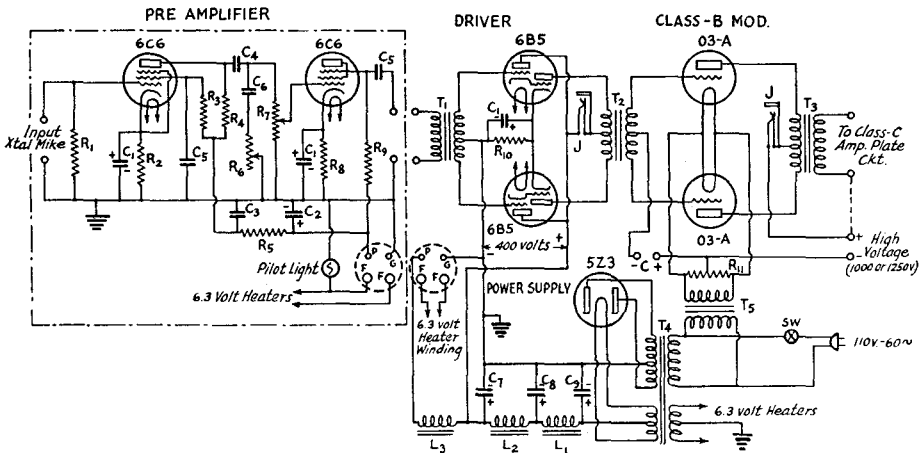

FIG. 1210 — COMPLETE CIRCUIT OF THE 250-WATT DRIVER-MODULATOR AND PRE-AMPLIFIER UNITS

$R_1$  — 4 megohms.

$R_2$  — 1000 ohms.

$R_3$  — 2 megohms.

$R_4$  — 500,000 ohms.

$R_5$  — 50,000 ohms.

$R_6$  — 500,000-ohm tone control.

$R_7$  — 500,000-ohm volume control.

$R_8$  — 1000 ohms.

$R_9$  — 100,000 ohms.

$R_{10}$  — 140 ohms.

$R_{11}$  — 60-ohm center-tapped.

$C_1$  — 20- $\mu$ fd. low-voltage electrolytic.

$C_2$  — 8- $\mu$ fd. electrolytic.

$C_3$  — 0.5  $\mu$ fd.

$C_4$  — 0.02  $\mu$ fd.

$C_5$  — 0.1  $\mu$ fd.

$C_6$  — 0.005  $\mu$ fd.

$C_7, C_8, C_9$  — Three-section electrolytic.

$L_1, L_2$  — 100-ma. filter chokes.

$L_3$  — 20 ma. filter choke.

$T_1$  — Any good audio step-up transformer, about 3-1 turns ratio.

$T_2$  — Coto C I 402 Triadyne output transformer.

$T_3$  — Coto C I 403 Class-B output transformer.

$T_4$  — Power transformer.

$T_5$  — 203-A filament transformer.

J — Plate meter jacks.

# The Radio Amateur's Handbook . . . . .

type (203-A, 838, 852, 803 or RK-28). A typical circuit for this size modulator, with a high-quality "Triadyne" 6B5 driver and high-gain pre-amplifier, is shown in Fig. 1210.

The speech-amplifier circuit follows the design principles previously outlined and is intended for use with a crystal microphone, gain

should be capable of furnishing 350 or more ma. at 1000 or 1250 volts, and of course should have good regulation (10 per cent or less).

## 500-Watt Class-B Modulator

● Fig. 1211 gives the circuit of the high-power modulator shown at the right in Fig. 1201 at the beginning of this chapter. This modulator represents the maximum size that can be used with amateur transmitters, since it is capable of modulating the 1-kw. maximum input permitted by the regulations. It is adaptable to other types of tubes, such as 204-A and 150T, as well as to the 354's shown. The driver should be capable of supplying 15 to 25 watts to the Class-B modulator grid circuit, depending on the tubes used and the operating conditions. (See Class-B modulator table for data.) The 6L6 unit previously described is recommended for the purpose. The construction of this type of modulator unit is straightforward, as is also its operation. It should be built up separately from the low-level audio stages, of course, and should have a plate power supply of good regulation capable of 2000 or 2500 volts at 325 or 350 ma.

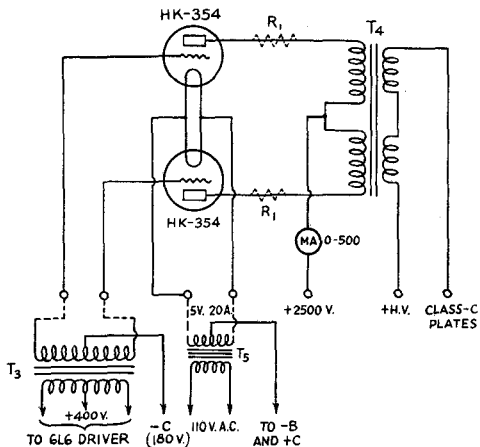

FIG. 1211 — CIRCUIT OF THE 500-WATT CLASS-B MODULATOR

- T<sub>3</sub> — Class-AB 6L6 to Class-B 354 input transformer, mounted in driver unit (UTC Type 18126).
- T<sub>4</sub> — 500-watt Class-B output transformer, 18,000 ohms to 5000 ohms (UTC Type VM-5).
- T<sub>5</sub> — Filament transformer, 5.25-volt 20-amp secondary (in power supply unit).
- R<sub>1</sub> — 10-ohm 10-watt parasitic suppressor resistors (not required unless modulator oscillates).

being controlled at the input to the second stage. The driver is of particular interest, employing 6B5 tubes on which data are given in the tube tables of Chapter Five. This driver also could be used as the modulator for a low-power Class-C stage operating with 40 or 50 watts input, the 6B5 combination having a rated output capability of 20 watts. The pre-amplifier is built as a separately-shielded unit. Power supply connection between the two units is made through the corresponding terminals of the two sockets indicated, using four-prong plugs with a 4-wire cable.

The Class-B output transformer shown would be used with 1000-volt type tubes in the Class-C amplifier. For 2000-volt tubes a transformer of the type having two secondary windings which may be connected in series for this voltage or in parallel for 1000-volt Class-C tubes would be used. If 838 zero-bias tubes are used in the modulator, the plus and minus "C" terminals would be connected together directly. The plate supply for the modulator

## Plate Modulation of Pentode Class-C Amplifiers

● Pentode-type screen-grid tubes such as the 802, RK-23-25, RK-20, RK-28 and 803 also can be used as Class-C modulated amplifiers provided the modulation is applied to both the plate and screen grid. Such use of these tubes is increasing, since they offer the advantages of requiring no neutralization and but small r.f. driving power as compared to triodes of similar capability. Modulation of the screen grid entails consumption of audio power additional to that supplied to the plate circuit by the modulator.

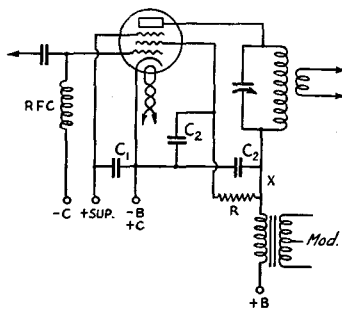

FIG. 1212 — PENTODE PLATE-MODULATION CIRCUIT WITH SCREEN-DROP RESISTOR

Screen and plate by-passes should be about .001  $\mu$ fd. The value of the screen dropping resistor, R, is 25,000 ohms for RK-23-25 and 802 tubes.

# . . . . Building Radiotelephone Transmitters

Two methods of feeding the screen grid with the necessary d.c. and modulation voltage are shown in Figs. 1212 and 1213. The dropping-resistor system of 1212 entails dissipation of audio power as well as d.c. in the dropping resistor *R*. This arrangement is fairly economical with the smaller pentodes (RK-23-25 and 802), but the power loss reaches considerable proportions with the larger types. Two of the smaller pentodes operating at 600 volts can be handled nicely by the "economy" Class-B modulator previously described, the total Class-C current being 84 ma., including both plate and screen input. A carrier output of approximately 40 watts would be obtained.

With the larger pentodes, such as the RK-20, RK-28 and 803, power loss in the screen dropping resistor makes this circuit uneconomical. For these tubes the arrangement of Fig. 1213 is preferable. This requires a special Class-B output transformer having an additional secondary winding for coupling to the screen circuit. This auxiliary winding has approximately 20 per cent as many turns as the plate secondary. Transformers of this type are available as standard units. These secondaries should be connected so that the audio voltage on the screen is in phase with that on the plate of the Class-C amplifier. With this type of coupling, the modulator load can be figured neglecting the screen consumption, since it is relatively small compared to the plate load.

The 100-watt modulator previously described can be used with a pair of RK-20's in push-pull or parallel in the Class-C amplifier, plate voltage and current being the same as specified for triodes. A 250-watt modulator such as the one shown in Fig. 1210 will handle a pair of 803's or RK-28's in the Class-C stage, also under the same operating conditions outlined for triodes. Screen voltage can be taken from a

separate 400- or 500-volt supply in the transmitter.

## Controlled-Carrier Plate Modulation

● The most practical method for controlled-carrier transmission adapted to Class-B modulation is illustrated by the diagrams of Figs.

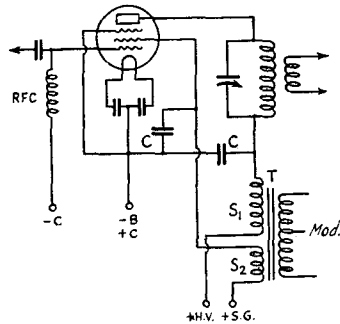

FIG. 1213 — MODULATION OF PLATE AND SCREEN THROUGH A SPECIAL OUTPUT TRANSFORMER HAVING AN AUXILIARY WINDING

A considerable saving in both d.c. and audio power results from the use of this type of transformer, since the power loss in the screen dropping resistor is eliminated.

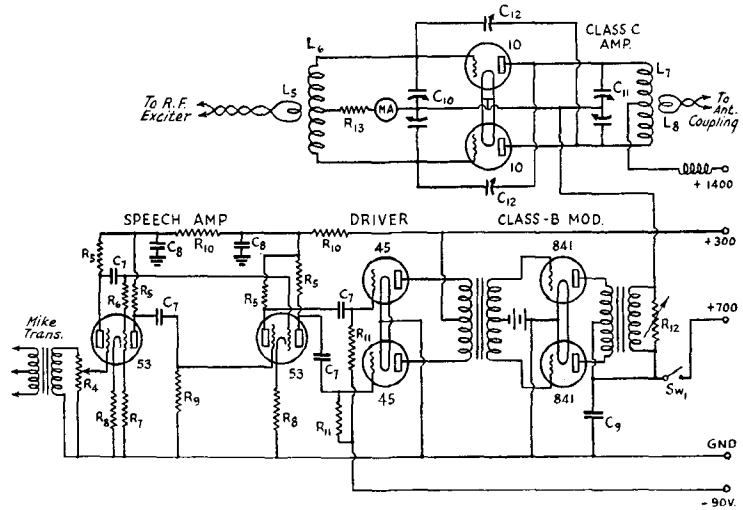

FIG. 1214 — CLASS-B CONTROLLED-CARRIER CIRCUIT FOR 500-VOLT TYPE TUBES (W2CTK)

- L*<sub>5</sub>, *L*<sub>6</sub>, *L*<sub>7</sub>, *L*<sub>8</sub> — To suit frequency.
- C*<sub>7</sub> — 0.1  $\mu$ fd. paper.
- C*<sub>8</sub> — 1.0  $\mu$ fd. paper.
- C*<sub>9</sub> — 2- to 3- $\mu$ fd. 2000-volt. (See text.)
- C*<sub>10</sub> — Double 35- $\mu$ fd. midget.
- C*<sub>11</sub> — Split-stator double-spaced, 50- $\mu$ fd. per section.
- C*<sub>12</sub> — Double-spaced 20- $\mu$ fd. midgets.
- R*<sub>4</sub> — 1-meg. vol. control.
- R*<sub>5</sub> — 0.1-meg. 1/2-watt.

- R*<sub>6</sub> — 240,000-ohm 1/2-watt.
- R*<sub>7</sub> — 10,000-ohm 1/2-watt.
- R*<sub>8</sub> — 300 $\Omega$ -ohm 1/2-watt.
- R*<sub>9</sub> — 250,000-ohm 1/2-watt.
- R*<sub>10</sub> — 50,000-ohm 1/2-watt.
- R*<sub>11</sub> — 1/2-meg. 1/2-watt.
- R*<sub>12</sub> — 25,000-ohm 20-watt, variable
- R*<sub>13</sub> — 3000-ohm 15-watt.

# The Radio Amateur's Handbook . . . . .

1214 and 1215. Tracing the control action in Fig. 1214, it is seen that the d.c. supply path of the Class-C amplifier is from the negative (gnd.) terminal to the filaments of the 841 modulators, thence through their two filament-plate circuits in parallel to the center-tap of the output transformer, from there through the secondary of this transformer to the filament center-tap of the Class-C stage. The positive connection is made to the center-tap of the r.f. tank circuit. The plate resistance of the two modulator tubes in parallel is therefore in series with the d.c. feed to the Class-C stage. This plate resistance varies inversely with the signal level, as the modulator grids are swung from nearly zero to considerably positive, the Class-C amplifier plate circuit resistance remaining practically constant. Condenser  $C_3$  filters off the audio-frequency ripple in this circuit, while the normal audio-frequency output of the modulator is super-imposed on the d.c. flowing in the series circuit in normal fashion. The circuit of Fig. 1215 is the same in principle, the only difference being that the secondary of the Class-B output transformer is in the positive side of the supply circuit instead of the negative. Resistance  $R_{12}$  of Fig. 1214 and  $R_2$  of Fig. 1215 may be used for the same purpose; that is, to pre-load the output circuit of the modulator to reduce the audio peak level.

In the adjustment of such systems, the negative grid bias of the modulator determines the "idling" carrier output. This bias should be no greater than for modulator plate-current

cut-off at one-half the total plate supply voltage, because the modulator plate voltage falls to this value when the effective series plate resistance of the modulator tube becomes equal to the Class-C amplifier plate circuit resistance, which is the condition at full modulation. If the bias is greater than cut-off, audio cycle bottoms will be clipped with resulting distortion.

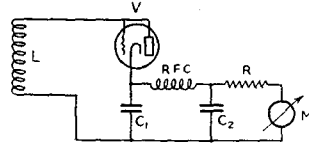

FIG. 1216 — CIRCUIT OF THE SIMPLE DIODE-TYPE CARRIER-SHIFT INDICATOR (W. C. Lent)

Typical circuit values are as follows:

- L — Coupling coil to suit frequency. It may be tuned by a midget condenser and coupled to the transmitter by a link.
- $C_1, C_2$  — 0.001-mfd. fixed condensers.
- R — 10,000-ohm non-inductive resistor, minimum value for 56, 59 or 89 tubes. Lower minimum value of 5000 ohms may be used with 53, 79 or 2A3 (all diode connected).
- M — 0-1 d.c. milliammeter.
- V — One of above tubes with grid (or grids) and plate tied together.

In the circuit of 1214, a power pack utilizing two 700-volt rectifier-filter units in series is used. The plus 700-volt terminal is connected to the midpoint of this supply system. Closing switch  $SW_1$  places a fixed voltage of this value on the modulator and equal voltage on the Class-C stage for constant-carrier operation. In the system of Fig. 1215, the negative feed lead to the Class-C stage would be opened at X and half-voltage similarly applied to both modulator and r.f. amplifier for continuous-carrier operation and adjustment. Tubes of similar voltage and plate-dissipation ratings should be used in both modulator and Class-C amplifier in controlled-carrier combinations of

this type. The adjustment is not especially critical, once the circuits have been tuned in normal procedure. Condensers  $C_3$  of Fig. 1214 and  $C_1$  of Fig. 1215 should have a capacitance of approximately 2 or 3  $\mu$ fd. No direct ground connection should be made to the Class-C filament circuit.

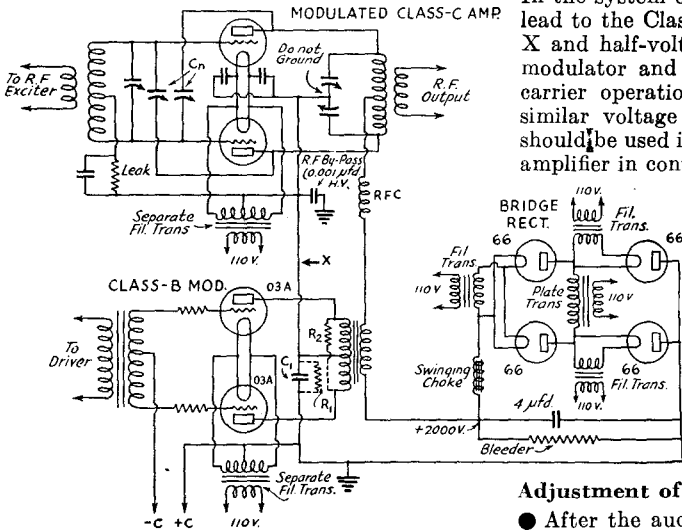

FIG. 1215 — CONTROLLED-CARRIER CIRCUIT FOR 1000-VOLT TUBES (W2HLM)

### Adjustment of Plate-Modulated Amplifiers

● After the audio section of the transmitter, including the modulator, has been checked for specified output with good quality (say with a

## . . . . Building Radiotelephone Transmitters

fixed resistance equal to the specified load value across the modulator output transformer secondary), the r.f. stage should be adjusted to present the proper load to the modulator output. All transmitter testing *excepting final tuning of the antenna circuit should be carried*

should be taken from the modulator output circuit to avoid phase difference between the modulation applied to the carrier and the audio signal applied to the oscilloscope. Such phase shift gives patterns which are difficult to interpret.

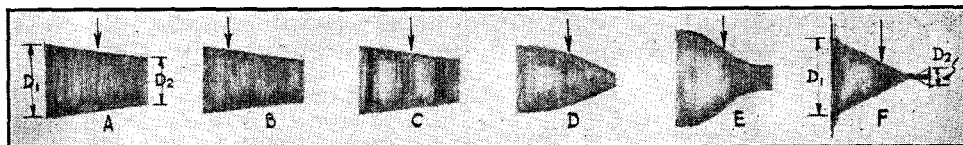

FIG. 1217 — SKETCHES OF TYPICAL TRAPEZOIDAL FIGURES REPRESENTING VARIOUS OPERATING CONDITIONS

The normal trapezoidal figure obtained with a medium degree of modulation is shown by "A". The modulation percentage is obtained by measurement of the dimensions  $D_1$  and  $D_2$ , and substituting in this simple equation

$$\text{Percent modulation} = \frac{D_1 - D_2}{D_1 + D_2} \times 100$$

Output containing even harmonics is represented in B; and C is typical of odd-harmonic content. Flat-topped positive peaks of the modulation envelope, as would occur with insufficient Class-C amplifier excitation, are represented in D, while E shows this condition combined with distortion of the negative peaks. F shows overmodulation, with the negative peaks cut off and with "whiskers" on the positive peaks. Arrows indicate carrier position without modulation. Further explanation of these figures is given in the text.

on with a dummy antenna load. Otherwise, needless and unlawful interference will be caused. Tuning and neutralizing are the same as for c.w. transmitters, described in Chapter Nine. Neutralization should be exact, because even slight regeneration can cause nonlinear modulation. Tank circuits for Class-C modulated amplifiers should be "medium low-C", having L/C ratios corresponding approximately to the optimum values recommended for c.w. transmitters. Extremely low-C will aggravate harmonic radiation, which may fall outside the amateur bands and attract unfavorable attention of the government monitoring stations.

Class-C modulated amplifiers require somewhat higher excitation than for the same unmodulated output in c.w. telegraph transmission. As in c.w. transmitters, no single figure of grid current can be specified as indicating proper excitation for a given tube. Excitation must be sufficient to maintain the output linear for plate-voltage variation up to twice the mean value. Operating checks, using either cathode-ray oscilloscope or carrier-shift indications, are the most certain. Oscilloscope patterns, obtained with a unit of the type described in Chapter Seventeen, are shown in Fig. 1217. These trapezoidal patterns result with the oscilloscope connected to the transmitter as shown in Fig. 1221. The leads marked "sweep terminals" connect to the horizontal cathode-ray plates, while the r.f. leads marked "signal terminals" connect to the vertical plates. The audio input to the oscilloscope

The patterns concerned with Class-C amplifier adjustment are Figs. 1217 D, E, and F, which show improper adjustment, and Fig. 1218 showing proper 100% modulation. The overmodulation shown in F is particularly to be avoided. The harmonic distortion indicated by A, B and C, revealed by streaking and shifting of the pattern, would most likely be traceable to the audio circuits and should be cleaned up by checking Class-A speech amplifier grid bias, audio overloading, etc. in the preliminary audio-unit testing.

The carrier-shift indicator is simply a linear rectifier, such as that diagrammed in Fig. 1216, showing flattening of the positive peaks like that illustrated in Fig. 1217-D by a drop in meter reading, or overmodulation as shown in F by an upward shift in meter reading.

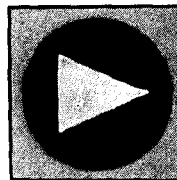
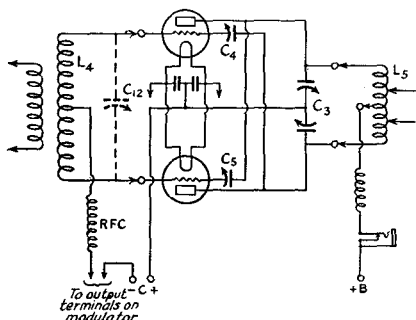

FIG. 1218 — ACTUAL PHOTOGRAPH OF TRAPEZOIDAL FIGURE FOR PROPER 100% MODULATION

### Grid-Bias Modulated Amplifiers

● The final amplifier circuit of the "general-purpose" transmitter described in Chapter Nine is shown modified for grid-bias modulation in Fig. 1219. A simple speech amplifier and modulator unit for use with the amplifier of Fig. 1219 is diagrammed in Fig. 1202. In this arrangement the secondary of the modulation transformer is in series with the grid-bias supply to the modulated amplifier.

Grid-bias for the amplifier may be from batteries, a separate bias power pack or can be taken from the power supply for the r.f. exciter stages. In this arrangement a separate filament winding is used for the amplifier tube



**FIG. 1219 — GRID CIRCUIT CHANGES IN THE FINAL AMPLIFIER OF THE GENERAL-PURPOSE TRANSMITTER TO FIT IT FOR GRID-BIAS MODULATION**

*Legends on components are the same as those given in Chapter Nine.*

and its center-tap is *not* connected directly to ground. Adjustable bias is taken off a voltage divider across a 400-volt supply so that the modulated-amplifier filament can be biased positive with respect to ground, which is the same thing as biasing the control-grid negative with respect to the filament.

In adjusting a grid-bias modulated amplifier, the grid-bias voltage is initially set slightly more negative than a cut-off value for the particular tube and plate voltage (see tube data in Chapter Five). Next, input tuning and coupling to the r.f. exciter, and antenna coupling and tuning, are adjusted for maximum possible antenna current. Then, leaving all other adjustments alone, the negative grid bias is increased until the plate current drops off to the proper operating value. This value is given for a number of tubes in the tables of Chapter Five. Generally, it should be the current corresponding to rated plate dissipation of the amplifier at the particular plate voltage used. When modulation is applied, it should be possible to cause the antenna current to increase and the plate current to rise simultaneously. This is not the operating condition for speech modulation, however. With speech modulation the antenna current should show rise of not more than 5 per cent on peaks, while the plate current of the amplifier should no more than flicker. Inability to obtain antenna current rise with test modulation shows that the positive peaks are being flattened off as shown in Fig. 1220-B. This figure shows oscillo-

graph patterns for both audio-frequency a.c. sweep (left) and synchronized linear sweep (right). If the antenna current cannot be made to rise, either there is insufficient audio modulation available, or the modulation characteristic is flattening equally on positive and negative peaks, as shown in Fig. 1220-C. The latter should be corrected by adjustment of coupling to the antenna and variation of the r.f. excitation. *The grid-bias modulator should not be adjusted for maximum efficiency.* In fact, for proper modulation the antenna loading will be somewhat greater than is ordinarily the case, the efficiency being necessarily reduced.

### Suppressor-Grid Modulated Amplifiers

● Pentode-type transmitting tubes can be grid-bias modulated as well as triodes, the same adjustment procedure being applicable. However, it is more convenient and usually more desirable to use suppressor-grid modulation with these types. The data of Chapter Five give the recommended ratings for this use of r.f. pentodes, as well as for grid-bias modulation. The suppressor-modulated amplifier behaves much like the grid-bias amplifier just described with respect to excitation and loading. In general, excitation should be somewhat higher and the load coupling somewhat greater than for maximum output conditions in c.w. telegraph operation, with correspond-

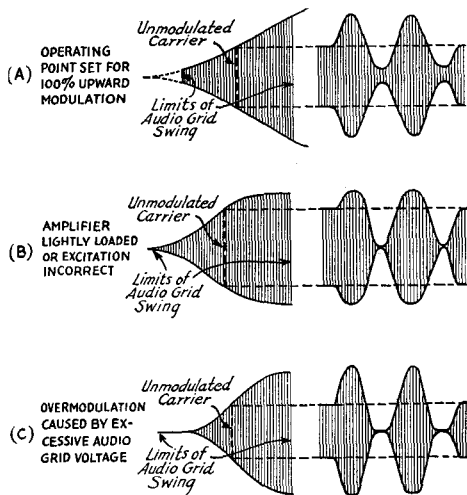

**FIG. 1220 — OSCILLOSCOPE PATTERNS REPRESENTING PROPER AND IMPROPER GRID-BIAS OR SUPPRESSOR-GRID MODULATION**

*The pattern obtained with a correctly adjusted grid-bias modulated amplifier is shown at A. The other two drawings indicate non-linear modulation, accompanied by distortion and a broad signal.*



## . . . Building Radiotelephone Transmitters

ingly reduced efficiency. The oscillograph patterns given for grid-bias modulation in Fig. 1220 are also typical of the suppressor-modulated amplifier for corresponding conditions.

### Overmodulation Indicators

● The most generally useful device for measuring modulation and for continuous checking against overmodulation is the cathode-ray oscilloscope described in Chapter Seventeen connected to the transmitter circuit as shown in Fig. 1221. The carrier-shift indicator discussed in connection with Class-C amplifiers, and schematically diagrammed in Fig. 1216, is the simplest device for continuous monitoring against overmodulation with constant-carrier transmission, although it will not indicate conditions such as that illustrated by Fig. 1220-B where the average amplitude of the modulated wave may remain constant even though modulation distortion is occurring. This particular type of distortion represents a more or less special case, however, and the carrier-shift indicator would be considered a generally satisfactory means to insure against overmodulation. It indicates positive-peak overmodulation by an upward shift in current reading, and flattening of positive peaks (accompanying modulation capability less than 100 per cent) by a decrease in current reading. If such carrier shift should be observed at very low modulation levels, with speech input or with a test signal from an audio source of known pure tone, it is likely that even-order harmonic distortion is occurring in the speech-amplifier or driver stages. This results in a "lop-sided" modulating signal waveform, which will give a correspondingly unsymmetrical modulation envelope. Such distortion commonly occurs with a short-circuited cathode-bias resistor in an early audio stage.

With controlled-carrier operation, the carrier-shift indicator is useless because the carrier is continuously varying. The cathode-ray oscilloscope picture also becomes less useful because there is no fixed average reference line. It will show overmodulation on the negative peaks, however. A simple negative-peak indicator which can be used as a suitable substitute is diagrammed in Fig. 1222. This

consists essentially of rectifier, *VT*, connected to the output side of the modulation choke of a Class-A system as shown, or to the corresponding side of the secondary of a modulator output transformer. When negative-peak modulation exceeds 100 per cent, current will flow through the rectifier circuit, although no current will flow as long as the filament of the rectifier tube is positive with respect to ground (minus B). The rectifier tube should have insulation capable of withstanding the maximum peak voltage (d.c. plus audio) applied to the modulated amplifier. The rectifier filament winding must be correspondingly insulated from the primary. Rectifiers of the

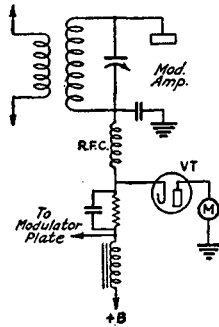

FIG. 1222—SIMPLE  
NEGATIVE-PEAK  
OVERMODULATION  
INDICATOR (W8AGW)

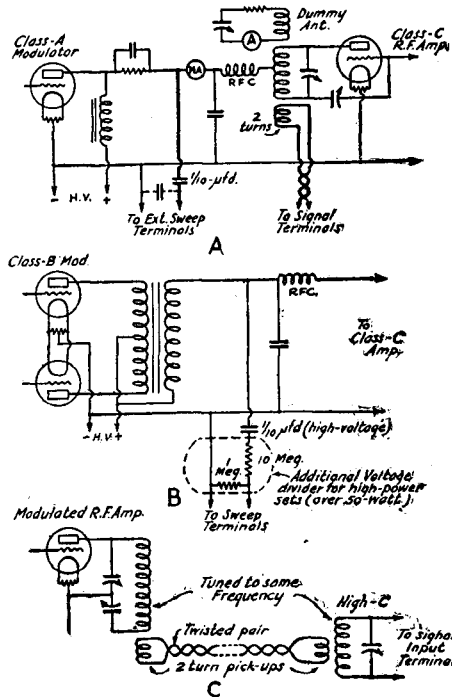

FIG. 1221—METHODS OF COUPLING THE OSCILLOSCOPE TO PHONE TRANSMITTER CIRCUITS (W1HRX-W1BZR)

vacuum type are preferable. Type 45, 80, 10, etc., tubes will be satisfactory for most amateur transmitters using controlled-carrier. The indicator, *M*, may be a low-range milliammeter.

In addition to these checking devices, the meters in the modulator and modulated amplifier circuit of the transmitter itself may be used to advantage, particularly when the set is periodically checked by an oscilloscope.

# 13

## *Receivers for the Ultra-High Frequencies*

### **GENERAL ASPECTS OF ULTRA-HIGH-FREQUENCY WORKING—SUITABLE RECEIVER TYPES—SUPER-REGENERATION—ADDING R.F. AMPLIFIERS—SUPERHETERODYNE CONVERTERS—ADVANCED RECEIVERS**

**I**N AMATEUR WORK, all frequencies higher than 56 megacycles have become known as the ultra-high frequencies. In this territory, relatively little intensive work was done until a few years ago. Naturally, only a few of its possibilities for amateur communication have so far been revealed. The lower frequencies have been studied and re-studied for

so many years that the experienced amateur of today knows fairly well, ahead of time, just what to expect in the way of performance with a given installation at a given time of day, month or year. In this respect, the ultra-high frequencies are different. On them, it is often the unexpected that happens, and because of this, ultra-high frequency workers are frequently provided with thrills over and above those experienced in the normal routine of amateur communication.

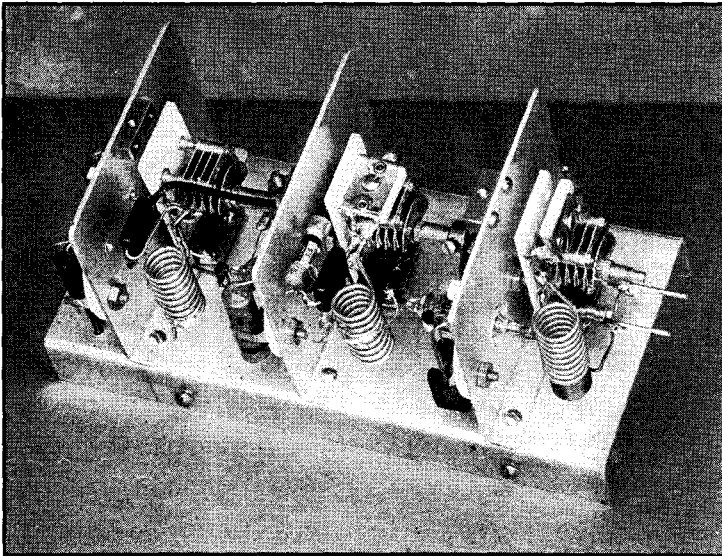

**FIG. 1301—A TYPICAL EXAMPLE OF A MODERN ULTRA-HIGH-FREQUENCY CONVERTER USING ACORN TUBES**

*A unit of this type, operated in conjunction with a good standard high-frequency receiver, allows excellent reception performance on frequencies up to about 200 mc. providing the transmitted signal is substantially free from frequency instability. Should the receiver be fitted with a modern noise silencer, the complete outfit is then about the last word in u.h.f. receiving equipment. A special i.f. amplifier with a lower order of selectivity is necessary to allow reception from transmitters using modulated oscillators.*

#### **Apparatus Developments**

● Because ultra-high frequency working is still very much in its infancy, it is subject to particularly rapid growth and change. Apparatus considered to be ideal today is quite likely to become antiquated tomorrow. It is therefore absurd to suggest that this chapter should be considered a complete survey of the field or that the equipment illustrated in it is the ultimate. Even as this is being written we can see developments on the horizon which are likely to result in many revisions of our present ideas. Our aim

## . . . *Receivers for the Ultra-High Frequencies*

and our only hope is to present the details of well-tried ultra-high frequency equipment, together with the general principles of its operation, knowing that the sincere worker will keep himself abreast of the new developments as they are presented from month to month in *QST*.

### What to Expect

● It is important that the amateur about to undertake ultra-high frequency work should realize that the very high frequency waves behave in a different manner to those of lower frequencies. On frequencies of 56 mc. and above, a bending of the waves in the Kennelly-Heaviside layer only infrequently brings the waves to earth at far-distant points. During brief, occasional periods during the summer and fall, 56-mc. signals have covered distances in excess of 500 miles. Such working, however, is extremely "spotty" and remains a field of activity valuable only to the experimenter.

Until recently, it was considered that only the "ground wave" was of any value for ultra-high frequency communication and that the range to be obtained from a low-lying station would be restricted substantially to the range of vision from that point. During the later part of 1934, experimental work at A.R.R.L. Headquarters revealed that ultra-high frequency waves were bent very appreciably in the lower atmosphere under certain atmospheric conditions. This work indicated that, on occasions when warm, moist tropical air was overrunning relatively cold and dry Polar air, communication could be had, even from low-lying stations, over distances of a hundred and sometimes two hundred miles. It was also shown that considerable bending of the waves in the lower atmosphere occurs at all times when a layer of warm air overruns a layer of colder air. Since this effect is to be found almost every night, one can expect to find that communication with points beyond the visible range is prone to become much more effective at night than during the day.

Since 1934 an ultra-high-frequency recording station has been maintained by the League at West Hartford making twenty-four-hour recordings of tone signals especially transmitted from the Blue Hill Observatory near Boston (95 miles away). These recordings have been studied in conjunction with meteorological data and a close relationship between conditions in the lower atmosphere and the effectiveness of 60-mc. transmission has been shown. This program has now been extended to embrace continuous recording on several different ultra-high frequencies in the hope of clearing

up some of the many unknowns in the general subject of ultra-high-frequency propagation.

The many factors concerned make it impossible to forecast the actual range of communication possible on the ultra-high frequency bands. It is generally considered, however, that the range to be obtained reliably with a very low-power transmitter and a normal type of antenna is about 10 percent greater than the visual range from the antenna. An increase of power immediately extends this range irrespective of whether the additional effective power is gained by using a bigger transmitter or a directive antenna. The combination of a fairly powerful transmitter (say 100 watts input), and a good directive antenna immediately permits a considerable extension of the range. One experimental station, maintained by the League, with such a transmitter set-up and with the antenna approximately 300 feet above sea level has, for example, maintained daily schedules over a distance of about 95 miles for more than a year. A great many amateur stations with plain antennas, lower-powered transmitters and lower elevation have communicated over even greater distances but it is obvious that a reduction of elevation, of transmitted power or a simplification of the antenna makes for a sacrifice of reliability over such long ranges.

This inability to forecast the range of an ultra-high frequency station is, in the minds of many, the very thing which makes the work of special interest. With equipment being improved every day and a more thorough knowledge of the effect of the atmosphere being gained, the unexpected is happening right along.

### Suitable Receiving Equipment

● The problems in devising receivers for the ultra-high frequencies differ considerably from those met on the low-frequency bands. In the early days of u.h.f. working the first equipment used was adapted from the straight autodyne receiver and the superheterodyne. These receivers suffered from poor sensitivity, tuning difficulties and severe interference from ignition and other similar noise. A big step forward was made by utilizing Armstrong's superregeneration principle for u.h.f. reception. Superregeneration immediately provided a receiver of tremendous sensitivity and a receiver in which an inherent operating characteristic resulted in invaluable discrimination against ignition noise. This type of receiver tuned very broadly and therefore removed, for the time being, the tuning difficulties. The superregenerative receiver has played probably

the biggest part of all in popularizing ultra-high frequency working. It was, and remains, one of the most extraordinary pieces of radio equipment ever developed — from the point of view of performance from a given amount of equipment.

now possible to put selective superheterodyne receivers to work even in routine communication.

A further development which has recently modified the place of the superhet in the u.h.f. picture is the Lamb noise silencer. With such a silencer the modern u.h.f. superhet is capable of much more effective discrimination against ignition noise than is the superregenerative receiver — a type of receiver which has always been valued for its abilities in this respect. Of course the complete superhet with noise silencer is a complex array of equipment obviously unavailable to many amateurs. Then its use is hardly practical or desirable for portable or mobile work. For these reasons the superregenerative receiver is still deserving of careful consideration.

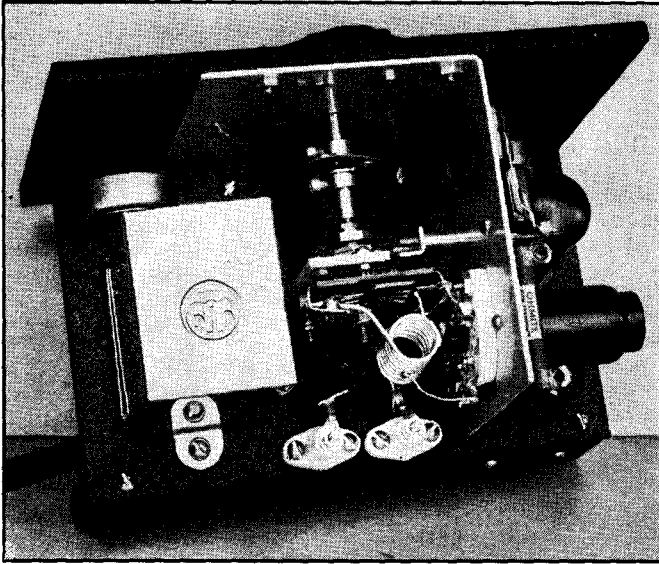

FIG. 1302—THE SUPERREGENERATIVE RECEIVER IN ONE OF ITS SIMPLEST AND MOST EFFECTIVE FORMS: A 56- AND 112-MC. RECEIVER USING METAL TUBES

*The detector in this receiver is of the self-quenched superregenerative type and feeds a conventional pentode audio amplifier. Particular care is necessary in the placement and wiring of the detector components in this type of set.*

While the early superheterodynes, using autodyne first detectors and very low frequency resistance- or transformer-coupled intermediate amplifiers, proved effective, they fell into disfavor because the performance was not in any way proportional to the complexities. Further, they always made a poor showing in comparison to the superregenerative type in locations where ignition interference was at all severe.

The trend today is toward the use of the superheterodyne principle for the prime purpose of gaining greater selectivity. In such receivers the intermediate frequency is often made relatively high for the purpose of avoiding excessive selectivity and gaining a reasonable freedom from image interference. Such receivers would have been impractical a year or two ago because almost all ultra-high-frequency transmitters were then of the unstable modulated-oscillator type. With the widespread adoption of stabilized transmitters it is

little attention on the part of research engineers, and as a result, the principle of operation is still only partly understood.

The general outline of superregenerative action is treated briefly in Chapter Five. The student of the subject anxious to have a more thorough knowledge of theoretical considerations might well study the excellent technical treatment by Ataka in the August 1935 issue of *The Proceedings of the Institute of Radio Engineers*.

From a practical aspect, superregenerative receivers may be divided into two general types. The first, in which the quenching voltage is developed by the detector tube itself — so-called "self-quenched" detectors. Second, the receivers in which a separate oscillator tube is used to generate the quench voltage. The self-quenched receivers have found wide favor in amateur work. The simpler types are particularly suited for portable equipment where the apparatus must be kept as simple as pos-

## The Superregenerative Receiver

● Though Armstrong announced the principle of superregeneration in 1922, it found little application in any actual receiving equipment until serious work began on the ultra-high frequencies. Strangely, the principle has been given very

## . . . Receivers for the Ultra-High Frequencies

sible. However, it is our strong recommendation that the separately quenched type be used in all cases where the ultimate performance is expected. One enormous advantage of the separately quenched type is that it is readily possible to adjust the operating conditions so that the receiver is extremely sensitive even under conditions when relatively little hissing or "mush" noise is had. In the separately quenched superregenerative detector it would appear to be of little consequence just how the quench voltage is introduced into the circuit providing the voltage is of the correct order and that quench frequency is something near the optimum value. Many amateurs have "pet" circuits which are claimed to be superior to all others. The probability is that the arrangement of their particular circuit has led to the use of correct operating conditions. It is certainly a fact that any of the various separately quenched circuits can be made to operate in substantially the same fashion by careful adjustment. Likewise, the self-quenched circuits are all capable of a somewhat similar performance. The latter, however, though very simple in appearance, require particularly careful handling in order to obtain smooth operation and a freedom from howling and generally irregular performance.

### Building Self-Quenched Receivers

● The circuit given in Fig. 1303 is representative of a very successful type. The entire receiver consists merely of a superregenerative detector feeding, through an ordinary audio frequency transformer, a pentode audio output tube. Such a receiver can be built inexpensively and quickly yet it is capable of an entirely satisfactory performance. The sensitivity of even this simple type of set is such that the normal background noise is the limiting factor in the reception of weak signals.

In this, and for that matter all other ultra-high frequency receivers, the mounting of the components and the location of the various leads are prone to play a curiously important part in the behavior of the set. Because no two layouts are likely to be precisely the same, it is therefore always advisable to experiment with the resistance and connection of the grid leak; taps on coils; the value of any r.f. choke and the size of placement of by-pass condensers. It is good practice always to run ground leads to a single point on the chassis of the set. Often, attention to this one detail results in the elimination of all instability problems.

The receiver shown in Figs. 1302, 1303 and 1304 is in many ways typical of the simpler

types of u.h.f. receivers and might well be examined in detail by the amateur unfamiliar with this branch of receiver design. The first and most important feature is that the components of the r.f. circuit are grouped closely around the detector tube socket so that all leads may be very short. Then it will be noted that the detector and its associated components are all mounted on a metal plate serving as a "ground" for the set. This plate, as it happens, is bent across the panel to serve also as a shield to prevent "hand-capacity" effects in tuning the receiver. This feature is made necessary by the use of a non-metallic panel. In many u.h.f. receivers metal construction is used throughout. In these cases, of course, the chassis itself is the "ground."

The chassis for the receiver under discussion is made from Tempered Masonite — a material which is proving popular particularly be-

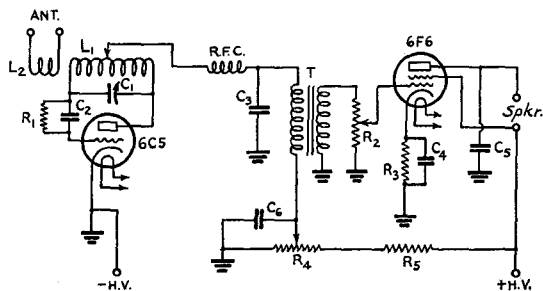

FIG. 1303 — CIRCUIT OF THE METAL-TUBE SELF-QUENCHED RECEIVER

$C_1$  — 15  $\mu$ fd. Cardwell Trim-Air midget condenser (with mounting bracket).

$C_2$  — 50  $\mu$ fd. midget fixed condenser.

$C_3$  — .003  $\mu$ fd. fixed condenser. Other values between .002 and .006  $\mu$ fds. are sometimes found more satisfactory.

$C_4$  — 25  $\mu$ fd. 50-volt electrolytic condenser.

$C_5$  — .002  $\mu$ fd. fixed condenser (not always essential).

$C_6$  — .25  $\mu$ fd. condenser — anything above 200-volt rating.

$R_1$  — 5 to 10 megohm gridleak — latter size used in original set.

$R_2$  — 500,000-ohm potentiometer.

$R_3$  — 500-ohm 2-watt fixed resistor.

$R_4$  — 50,000-ohm potentiometer.

$R_5$  — 50,000-ohm half-watt resistor.

$L_1$  — Eight turns of No. 14 wire  $\frac{1}{2}$ -inch diameter spaced to occupy 1 inch for 56-mc. band. Four similar turns spaced to same length for 112-mc. band. Change of these values may be necessary in cases where the layout differs.

$L_2$  — Four turns of No. 18 wire  $\frac{3}{8}$ -inch diameter. This will usually serve for both bands.

R.F.C. — Ohmite u.h.f. choke. About 50 turns of No. 30 wire on a  $\frac{1}{4}$ -inch bakelite rod with turns spaced to occupy 1 inch will serve. Adjustment is sometimes necessary to give freedom from "dead spots."

T — UTC Type CS1 audio transformer. "Bargain store" audio transformers are invariably a failure in this type of receiver.

cause of the ease with which it can be worked. The base measures 7 by 4½ inches, the panel being 7½ by 5 inches. The aluminium angle piece on which the detector assembly is mounted is the full depth of the base and the full height from the base to the top of the panel. The tuning condenser and detector tube

an essential in this particular receiver though it is not invariably so. On the other hand, a resistor of a quarter or half megohm is often necessary across the secondary of the audio transformer to kill "fringe howl" effects which often occur at certain settings of the detector plate-voltage-control resistor.

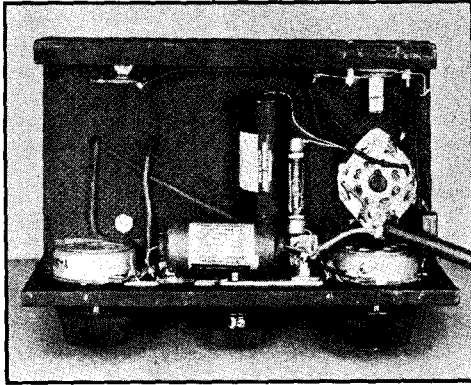

FIG. 1304 — THE UNDER SIDE OF THE TWO-TUBE RECEIVER

*The components not shown in the first illustration may be readily identified in this one. No special care is necessary in the wiring of the audio section providing the detector portion has had its bugs removed.*

are mounted far enough back on it to accommodate a flexible coupling between the condenser and the dial. This coupling is essential since both sides of the condenser are at high r.f. potential. The detector socket is tilted so that the grid and plate terminals come directly opposite the corresponding terminals on the tuning condenser. The total length of connecting leads is then only a fraction of an inch. The r.f. choke and by-pass condenser (which happens to be two condensers in parallel to give the desired capacity) are located on the other side of the metal piece carrying the detector unit. In other respects, the receiver follows normal practice.

The circuit of the receiver, shown in Fig. 1303, appears to be very simple but, in this type of receiver requires quite careful treatment. Very erratic behavior may result from incorrect adjustment of the tap on  $L_1$ , from the use of an r.f. choke of the wrong size or from the use of long return paths to ground from the detector cathode or from the by-pass condenser  $C_3$ . The by-pass condenser  $C_5$  happened to be

The receiver circuit as shown is designed for the operation of a loud speaker. The heavy plate current of the pentode output tube will quickly ruin a pair of head phones unless a coupling choke and condenser or a coupling transformer is used. For head-phone work it is better to use a 6C5 in the output stage — in which case the bias resistor  $R_3$  should be increased to 5000 ohms. No other change in the wiring is necessary since the lead to the second grid of the 6F6 will be open when the 6C5 is plugged in.

Successful operation of this receiver is dependent to a considerable degree on the type of antenna used and the manner in which it is tuned. The chief requirement is that the detector circuit be heavily loaded by the antenna.

### A Self-Quenched Acorn-Tube Receiver

● In Fig. 1305 is illustrated a somewhat similar type of receiver except in the type of detector tube used. In this case the acorn detector, because of its extremely small elements and short leads, allows operation on frequencies as high as 300 mc. The receiver to be described is therefore a particularly useful one

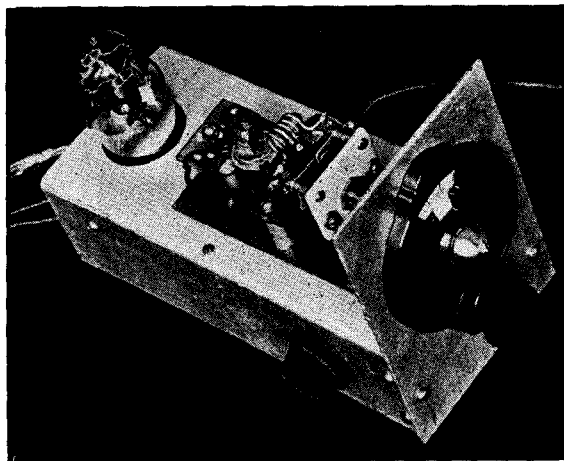

FIG. 1305 — A SELF-QUENCHED RECEIVER USING THE ACORN TUBE TO PERMIT OPERATION UP TO 224 MC.

*All-metal construction is used for the chassis, the audio transformer and other non-r.f. components being mounted in the space underneath the base. The audio tube socket is dropped down from the surface of the base to permit restricting the height of the front panel.*

## . . . Receivers for the Ultra-High Frequencies

in cases where experiment is to be conducted on the bands higher in frequency than 112 mc. The circuit itself is quite similar to that of Fig. 1303 except in minor details. The grid resistor is again connected to the coil carrying high voltage but in some instances it is preferable to run it in the conventional manner between the grid and cathode. The other important difference in this circuit is that the tuning condenser is of the split-stator type. By splitting the stator plates of the small tuning condenser used, the path through the condenser is reduced in length and extremely short connections between the coil and condenser are made possible. The connection of the condenser in this circuit is indicated in Fig. 1306 and the mechanical arrangement is shown in Fig. 1307. The acorn tube itself is mounted on a socket made with small strips of National Vietron. One of the excellent acorn tube sockets available could, of course, be used instead. It is obvious from the illustration that a special attempt has been made to reduce the

length of leads in the r.f. circuit. This procedure is very necessary in any tuning unit which is intended for operation on the 112- and 224-mc. bands. The grid condenser  $C_2$  is made with two pieces of light brass or copper about  $\frac{3}{8}$ -inch square cemented with Duco cement to a thin piece of mica. One of the very small midget

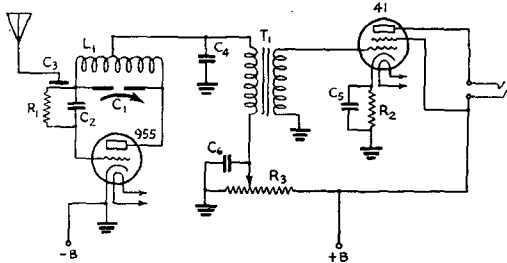

FIG. 1306 — CIRCUIT OF THE "ACORN" RECEIVER

- $L_1$  — Five turns of No. 14 wire  $\frac{1}{4}$ -inch inside diameter with turns spaced diameter of wire, for 224 mc. Five similar turns  $\frac{1}{2}$ -inch diameter for 112 mc. Fourteen turns of same diameter for 56 mc.
- $C_1$  — Cardwell Type ZR 15AS condenser — Special split-stator tuning condenser — two rotor and one stator plate — the latter sawed in two.
- $C_2$  — Very small grid condenser (see text).
- $C_3$  — Brass strip  $\frac{3}{16}$  inch wide mounted close to the exposed surface of  $C_2$  (see Fig. 1307).
- $C_4$  — .002  $\mu$ fd. fixed condenser.
- $C_5$  — 10  $\mu$ fd. electrolytic condenser.
- $C_6$  — 1  $\mu$ fd.
- $R_1$  — 5 to 10 megohms.
- $R_2$  — 1200 ohm, one-watt resistor.
- $R_3$  — 100,000 ohm potentiometer. Note that this resistor is across plate supply and that, if batteries are used, the supply should therefore be disconnected when switching off set.

A 41 tube is used as the audio amplifier and allows speaker operation. A transformer or choke-condenser coupling unit must be used with this tube. For head-phone work, a 37 audio tube would probably be more appropriate.

Quieter operation may sometimes be obtained by putting a .5 megohm resistor across the transformer secondary.

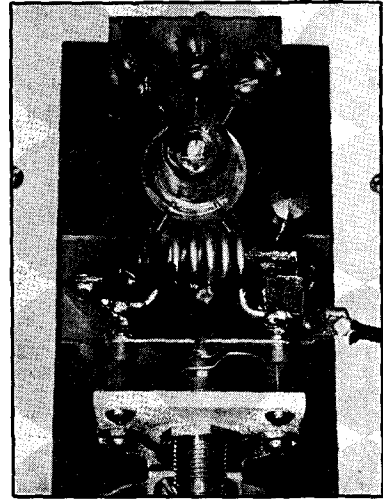

FIG. 1307 — THE "ACORN" DETECTOR TUBE AND ITS TUNING EQUIPMENT

The grid condenser may be seen immediately to the right of the coil. The brass strip of the antenna coupling condenser can be seen apparently touching the right-hand coil connection.

condensers of 50  $\mu$ fd. will serve instead. The suggested sizes for coils for the three bands are, of course, approximate only. Slight variation of the length of the leads within the tuned circuit will result in modification of the coils. Fortunately, small variations of the inductance can be made readily by spacing the turns until the desired tuning range is obtained.

### Receivers With Separate Quenched Oscillators

While the self-quenched receivers just treated are entirely satisfactory for much experimental work and have the merit of extreme simplicity, it must be admitted that a considerable improvement in performance can almost invariably be obtained by using a separate tube to produce the required quenching voltage. Innumerable circuits have been devised to provide appropriate coupling between the quench oscillator and the detector itself and it is, of course, obviously impossible to cover them all.

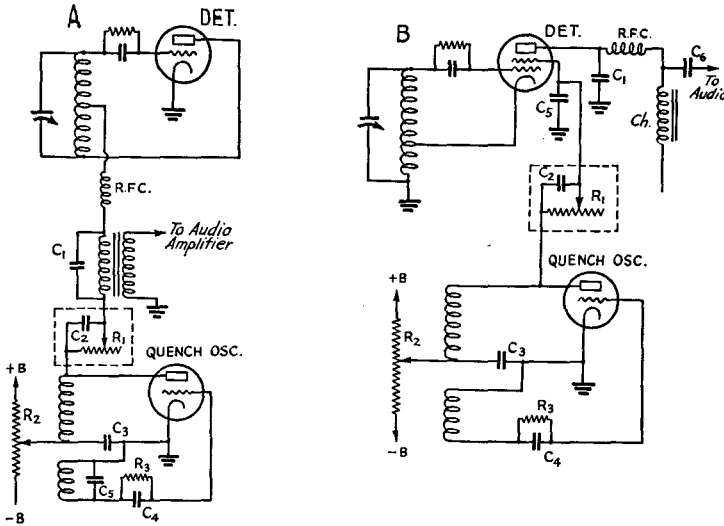

FIG. 1308 — TWO TYPICAL METHODS OF APPLYING QUENCH VOLTAGE TO THE SUPERREGENERATIVE DETECTOR

Circuit "A" is one of the most successful types using a triode detector while that at "B" shows what is probably the most satisfactory for use with a screen-grid detector. Typical values for the components marked are:

$C_1$ — .002 to .004 $\mu$ fd.	$C_5$ — .002 $\mu$ fd.
$C_2$ — .1 to .5 $\mu$ fd.	$R_1$ — 100,000 ohms.
$C_3$ — .1 $\mu$ fd.	$R_2$ — 50,000 ohms.
$C_4$ — .001 $\mu$ fd.	$R_3$ — 50,000 ohms.

Circuit "B" can be understood more readily if it is noted that the screen by-pass condenser  $C_5$  is also serving as the tuning condenser across the plate coil of the quench oscillator.

Fig. 1308 illustrates the detector and quench oscillator portion of two typical superregenerative circuits having a separate quench oscillator tube. The arrangement shown at "A" is probably the most effective one for use with a triode detector. The plate winding of the quench oscillator is so connected that it is able to serve the same purpose as the modulation choke in a conventional plate-modulated transmitter. In this case, though, the modulation is applied to both grid and plate of the detector. The condenser  $C_1$  effectively by-passes the audio-frequency transformer primary as far as the quench voltage is concerned. Its capacity is usually between .002 and .004  $\mu$ fd. — a value which does not cause serious

loss of high audio frequencies yet by-passes the quench voltage. The purpose of  $R_1$  and  $C_2$  is to permit variation of the detector plate voltage without upsetting the voltage on the quench oscillator plate. In some cases individual adjustment of the quench oscillator and detector voltages results in an improved performance but practice had indicated that the additional components required ( $R_1$ ,  $C_2$ ) are hardly justified.

The diagram "B" in Fig. 1308 illustrates what we believe to be the most successful method of applying the quench voltage to a screen-grid detector. In this instance the screen of the detector is modulated by the quench oscillator in the same manner as were the grid and plate in the triode circuit. Much experimental work has been done in studying the effect of applying the modulation to other grids in receivers of this general type but screen-grid modulation has so far not been excelled. In this circuit again are

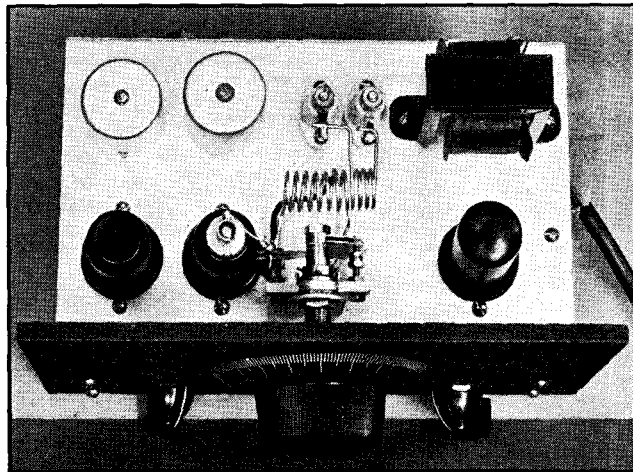

FIG. 1309 — A METAL-TUBE RECEIVER EMPLOYING A SEPARATE QUENCH OSCILLATOR TUBE IN A CIRCUIT OF PROVEN EFFECTIVENESS

Plenty of space is provided for components above and below the base but care is taken to group the detector portion so that long leads are avoided.



## . . . Receivers for the Ultra-High Frequencies

shown the additional components required for separate control of the detector screen voltage. They are possibly more desirable in arrangement "B" than in "A" but in either case are not essential.

It should be realized that the performance of all the various circuits is very similar providing

the optimum operating conditions are obtained. The important factors are the screen and plate voltages on the detector, the order of quench voltage applied to the detector and the frequency of the quench voltage. Of these factors, probably the least critical is the quench frequency but it has been shown that there exists an optimum frequency for each signal frequency. The normal superregenerative receiver is very tolerant in this respect and it is usually found that a quench frequency of about 100 kc. is entirely suited for 56-mc. and 112-mc. operation. A slight increase in the quench frequency may be found desirable for 224-mc. operation and work at still higher frequencies.

### A Separately-Quenched Metal-Tube Receiver

● A typical u.h.f. receiver using a separate tube to generate the quench frequency is that illustrated in Figs. 1309 to 1311. This type of set, using a metal-tube detector, is suited for operation on the 56- and 112-mc. bands but would not be satisfactory on frequencies much higher than that. The receiver is simple in general design but is capable of an excellent performance when correctly adjusted.

From the circuit diagram it can be seen that the detector is of the "electron-coupled" type — the screen being grounded through  $C_3$  and serving as what could be considered the plate of a grounded plate oscillator. This detector circuit has the advantage of allowing the frame of the tuning condenser to be grounded. The quench oscillator portion of the circuit is similar to that shown at "B" in Fig. 1308, the quench voltage being applied to the screen of the detector with the screen by-pass condenser serving as the tuning condenser for the plate coil of the quench oscillator.

An important feature of the circuit is the filter  $L_3, C_{11}, C_{12}$ . This filter is tuned to the quench frequency and prevents the quench

voltage from reaching the audio tube thus greatly improving the operation of the audio stage.

The receiver itself is built on a folded aluminium chassis 5 by 8 by 2 inches. The tuning condenser, supported on a metal angle piece is mounted in the center front of the

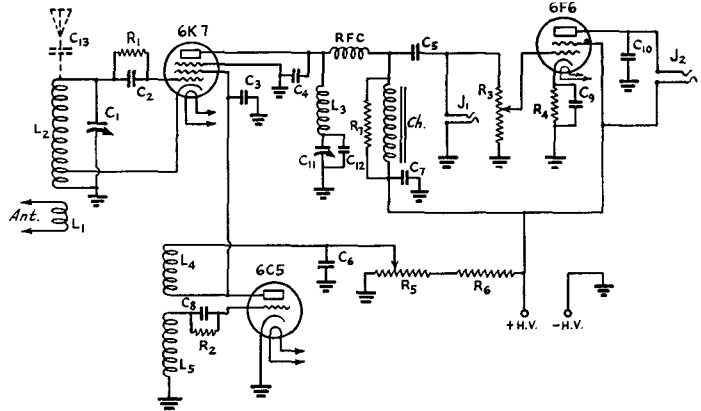

FIG. 1310 — CIRCUIT OF THE SEPARATELY-QUENCHED RECEIVER

- $L_1$  — Four turns of No. 14 wire  $\frac{1}{2}$ -inch diameter.
- $L_2$  — Seven turns of No. 14  $\frac{1}{2}$ -inch diameter spaced to occupy a length of one inch for 56 mc. Three similar turns will be required on 112 mc.
- $L_3$  — 80 millihenry choke.
- $L_4, 5$  — Coils of National quench oscillator unit. In this circuit arrangement the coils are reversed, "G" being connected to the plate and "p" to the grid.
- $C_1$  — National STHS 15 —  $15\mu\text{fd}$ . tuning condenser. The frequency coverage with this condenser is from 68 to 51 mc. One rotor plate could be removed to give greater band spread.
- $C_2$  —  $50\mu\text{fd}$ . midget condenser.
- $C_3$  —  $.002\mu\text{fd}$ .
- $C_4$  —  $.001\mu\text{fd}$ .
- $C_5$  —  $.01\mu\text{fd}$ . tubular type condenser.
- $C_6, C_7$  —  $.1\mu\text{fd}$ . tubular type condensers.
- $C_8$  —  $.001\mu\text{fd}$ .
- $C_9$  —  $25\mu\text{fd}$ . 50-volt electrolytic condenser.
- $C_{10}$  —  $.002\mu\text{fd}$ .
- $C_{11}$  —  $100\mu\text{fd}$ . mica trimmer condenser.
- $C_{12}$  —  $200\mu\text{fd}$ . midget — this value may have to be modified to take care of possible differences of the inductance of  $L_3$ . The circuit must tune to the quench frequency.
- $C_{13}$  — 1 to  $5\mu\text{fd}$ . coupling condenser used as an alternative to inductive antenna coupling. A  $15\mu\text{fd}$ . mica trimmer with the plates bent at about 45 degrees is usually suitable.
- $R_1$  — 2 to 5 megohms — the latter value in the original set.
- $R_2$  — 50,000 ohm half-watt resistor.
- $R_3$  — 500,000-ohm potentiometer.
- $R_4$  — 500-ohm two-watt resistor.
- $R_5$  — 50,000-ohm variable resistor.
- $R_6$  — 10,000-ohm one-watt resistor.
- $R_7$  — 0.5 megohm half-watt resistor.
- R.F.C. — Ohmite u.h.f. choke. About 50 turns of No. 30 on  $\frac{1}{4}$ -inch bakelite rod with turns spaced to occupy one inch will serve.
- Ch. — Thorndarson T2927 choke.

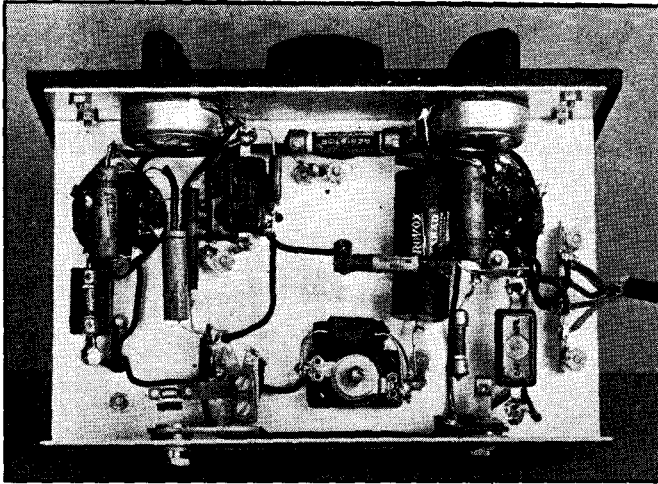

FIG. 1311 — THE UNDERSIDE OF THE METAL-TUBE RECEIVER

*Plate and screen by-pass condensers for the detector are run directly to one point on the chassis immediately under the tuning condenser mounting. All other leads are made short and direct chiefly to give greater rigidity.*

chassis in such a position that the grid condenser and leak run directly upward to the detector grid cap from the stator lug of the tuning condenser. The grid coil  $L_2$  is mounted horizontally and at its grounded end the antenna coil  $L_1$  is placed. The latter coil, mounted to lugs on a pair of stand-off insulators, may be moved up or down to vary the antenna coupling. To the left of the detector in Fig. 1309 is the quench oscillator tube and behind it the shielded quench oscillator coil unit and the shielded choke  $L_3$ . The tube and choke at the right belong, of course, to the audio department.

The underside view shows the detector and quench oscillator at the left together with the voltage control  $R_5$  and the 'phone jack. In the center front are the condensers  $C_{11}$  and  $C_{12}$  of the quench filter while at the right the audio amplifier components may be seen. The panel, of Masonite, is  $8\frac{1}{2}$  by 5 inches and on it is fitted the National Velvet Vernier dial — old-fashioned in appearance, perhaps, but still one of the smoothest working dials available.

The one really important point to watch in

wiring the set is to make all ground leads in the detector portion of the circuit to one point on the chassis or at least to points within a radius of half an inch or so. It should be noted that the suppressor is not returned to cathode as in normal practice but to ground. The cathode tap on  $L_2$  will usually be about one fourth the length of the coil from the grounded end. It should be adjusted for best performance. The adjustment of the quench filter can best be made with an output meter or cathode ray oscilloscope connected across the output of the receiver. With no antenna connected, the filter tuning condenser should be adjusted until the output from the set is at a minimum. This output is, of course, chiefly of the superaudible quench frequency. For this reason,

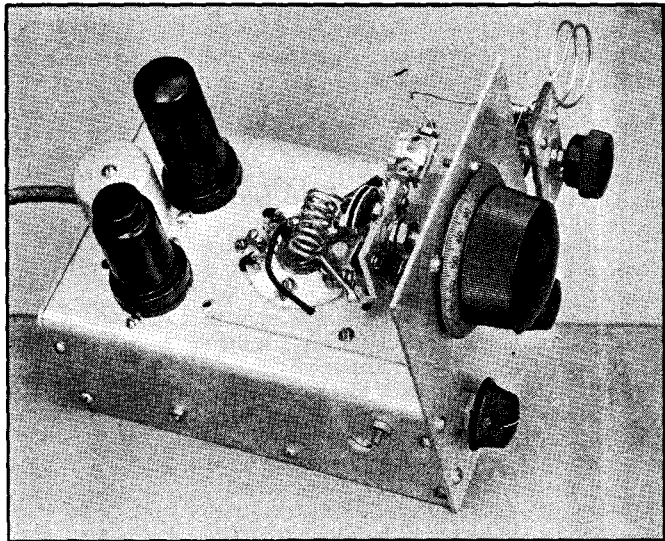

FIG. 1312 — THE ACORN TUBE IN A SEPARATELY-QUENCHED RECEIVER

*The r.f. portion of the circuit is grouped closely around the tube socket and all by-pass condensers grounded at a point on the base immediately behind the cathode terminal of the detector tube socket. This type of receiver is suggested for work on frequencies of 112 mc. and higher. It has no higher performance on 56 mc. than receivers using a conventional detector.*

## . . . Receivers for the Ultra-High Frequencies

the adjustment cannot be made with a speaker or 'phones as the output indicating device.

### Separate Quenching for the Acorn

● The receiver illustrated in Figs. 1312 and 1313 is a typical example of the manner in which an Acorn detector may be arranged with a separate quench oscillator. This receiver is suited for operation on frequencies up to about 250 mc. Quench voltage is applied to the detector in the manner shown at "A" in Fig. 1308 but in other respects the set is similar to those already described. One difference in the circuit is in the connection of the quench filter across the grid circuit of the audio tube. This filter, as has already been explained, is a desirable but not essential refinement.

The chassis of this receiver is built entirely of aluminium, the folded base portion measuring  $6\frac{1}{2}$  by 4 inches. It is made  $2\frac{1}{2}$  inches deep to accommodate the audio coupling choke underneath the base. It will be noted that the detector tube and its associated components are all grouped closely together. The use of a tuning condenser with its one stator plate split down the center allows very short leads to the grid and plate terminals of the tube socket and short leads to the coil itself. The audio and quench units are grouped at the rear end of the chassis. The appendage on the right side of the panel is a tuned circuit used for coupling the antenna feeders. Coupling to the grid of the detector is through a very small condenser (a modified two-plate mica trimmer condenser) connected to the stator of the tuning condenser in the antenna circuit.

### Superregenerative Receivers With R.F. Amplifiers

● One important disadvantage of the simple superregenerative receivers just described is that they are capable of severe radiation. Also, as we have already stated, they are extremely unselective. Prevention of the radiation and some improvement in selectivity is made possible by adding an r.f. amplifier stage ahead of the superregenerative detector. Fig. 1314 illustrates various methods of coupling the r.f. stage to the detector. All of them have been shown to be effective in practice but each has its particular points of merit. The circuit shown at "A" will be recognized as an example of conventional transformer coupling with normal wiring of the r.f. amplifier itself. The best number of turns for  $L_3$  will usually be just slightly less than that used in  $L_4$  but this depends upon the order of coupling between the two coils and the order of freedom with which the detector superregenerates. One of the

difficulties in this arrangement is in providing a suitable mechanical arrangement for mounting the coils.  $L_4$  may be wound on a former of some good insulating material with the turns of  $L_3$  occupying the spaces between the turns of  $L_4$  but many workers prefer to avoid any

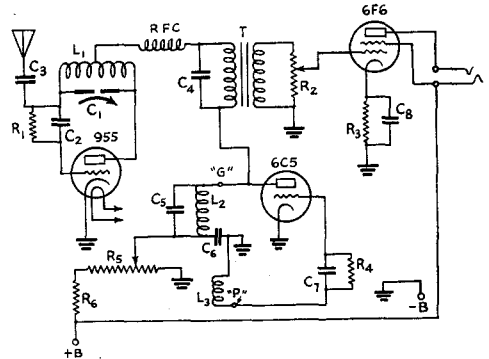

FIG. 1313 — WIRING OF THE ACORN-TUBE RECEIVER

- $L_1$  — Five turns of No. 14 wire  $\frac{1}{4}$ -inch inside diameter with turns spaced diameter of wire for 224 mc. Five similar turns  $\frac{1}{2}$ -inch diameter for 112 mc. 14 similar turns for 56 mc.
- $L_2, L_3$  — Coils of National Quench-frequency oscillator unit. The coil connections are reversed as indicated.
- $C_1$  — Cardwell Trim-Air condenser with one split stator plate and two rotor plates.
- $C_2$  — 50  $\mu$ fd. midget condenser.
- $C_3$  — 30  $\mu$ fd. mica trimmer with upper plate bent at about 45 degrees to lower plate.
- $C_4$  — .004  $\mu$ fd.
- $C_5$  — .002  $\mu$ fd.
- $C_6$  — .5  $\mu$ fd.
- $C_7$  — .001  $\mu$ fd.
- $C_8$  — 25  $\mu$ fd. 50-volt.
- $R_1$  — 5 megohms.
- $R_2$  — 500,000 ohm potentiometer.
- $R_3$  — 500-ohm 2-watt resistor.
- $R_4$  — 50,000 ohm half-watt.
- $R_5$  — 50,000-ohm variable resistor.
- $R_6$  — 25,000-ohm one-watt.
- R.F.C. — Ohmite u.h.f. choke.
- T — Any good  $2\frac{1}{2}$  or 3 to 1 ratio audio transformer.

dielectric in the field of u.h.f. coils. Then,  $L_3$  may be wound on a slightly smaller former pushed inside the turns of  $L_4$ . One effective alternative scheme is to make  $L_3$  of about 30 gauge d.s.c. wire with the turns cemented to the turns of  $L_4$  with Duco cement or its equivalent. Yet another method is to make  $L_3$  a self-supporting coil of No. 18 wire of a diameter just sufficient to slide inside  $L_4$ . In this case,  $L_3$  might well be mounted from small stand-off insulators.

The circuit "B" is probably the most popular method of coupling the r.f. stage to a screen-grid detector since it avoids mechanical difficulties and provides a very simple method

of adjusting the coupling. In this case the high voltage flows through the detector grid coil and it must therefore be isolated from ground by the condenser  $C_5$ . The rotor of  $C_2$  may either be ungrounded and connected to the coil itself

adding an r.f. stage to the type of receiver shown in Fig. 1310.

The arrangement shown at "C" in Fig. 1314 is particularly suitable in receivers having the high voltage applied to the detector coil as in Figs. 1303 and 1306. The plate lead is merely tapped near the grid end of the detector coil with no other modification to the detector circuit.

Circuit "D" in the same illustration is a general-purpose affair suited for almost any receiver. In this arrangement the plate voltage is applied to the r.f. tube plate through a good u.h.f. choke, a coupling condenser of 5 to 15  $\mu\text{fd}$ . then being connected between the r.f. plate and the grid end of the detector coil. Coupling is varied by changing the capacity of  $C$ .

In all of the circuits the most important adjustment is the order of coupling between the r.f. tube and the detector. The superregenerative detector is extremely sensitive to changes of the load on its grid circuit and usually operates most effectively when heavily loaded. On the other hand, tight coupling and the consequent heavy loading of the detector will not allow the maximum possible r.f. selectivity. The coupling adjustment should therefore be varied to give the desired optimum performance considering both selectivity and sensitivity.

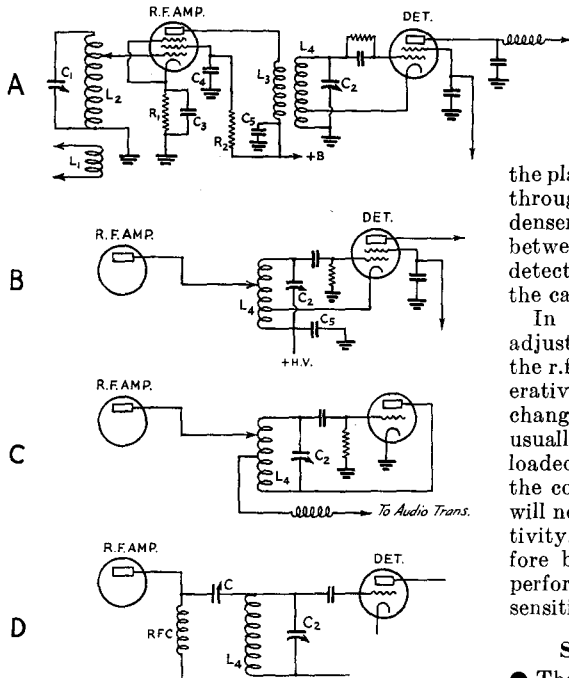

FIG. 1314—FOUR EFFECTIVE METHODS OF COUPLING AN R.F. AMPLIFIER TO THE SUPER-REGENERATIVE DETECTOR

Assuming that the r.f. amplifier is a 954 acorn, suitable values for the various components marked will be:

$R_1$  — 1500-ohm half-watt.

$R_2$  — 100,000-ohm half-watt.

$C_1, C_2$  — 15  $\mu\text{fd}$ . Some difficulty may be had in making the two condensers "track" if a conventional tube is used as a detector. If single dial operation is essential,  $C_1$  may be loaded with a 15  $\mu\text{fd}$ . trimmer in parallel to provide the equivalent of the higher tube capacity across  $L_4$ . A separate control for  $C_1$  or a parallel trimmer condenser available for control from the front panel is very desirable.

$L_2$  will be exactly similar to  $L_4$  — the usual detector grid coil.  $L_1$  should comply with the specifications given for the usual antenna coil. Since variation of its coupling will have relatively little effect on the regeneration in the detector it may usually be operated closer to the grid coil than would be possible in the receiver lacking an r.f. stage.

Other features of these circuits are discussed in the text.

or connected to the grounded side of  $C_5$ . In the latter case the tuned circuit includes  $C_5$  in series with the normal tuning condenser. We would suggest that this circuit be used in

### Suitable Tubes for R.F. Amplifiers

● The Type 954 Acorn pentode is, without the slightest doubt, the most effective r.f. amplifier for u.h.f. work. It is, indeed, so far superior to the conventional glass or metal tubes that the serious u.h.f. worker is rarely inclined even to consider using anything else. Even on 56 mc. the 954 is incomparably superior to the normal screen-grid pentode. On the higher frequencies it is the only available tube which will provide r.f. gain.

In cases where the chief purpose of an r.f. amplifier is to reduce radiation from the receiver and where some slight gain is all that is required, the 6K7, 6D6 or 58 may be used. With careful adjustment of the plate-to-detector coupling and proper planning of the r.f. wiring a satisfactory performance can be had.

Suggestions for the mechanical arrangement of the r.f. stage may be gained from the illustrations of superhet converters in Figs. 1315 and 1319. In general it will be found that quite simple shielding will serve to prevent oscillation, providing the by-passing has been done carefully. A simple baffle, such as that used in the converter shown in Fig. 1301,

## . . . Receivers for the Ultra-High Frequencies

is probably the most practical arrangement for the 954 — the tube socket being mounted on the baffle or partition and the tube grid protruding through a small hole in the metal. The most satisfactory socket available for this type of amplifier is the National Type XMA metal socket. Excellent by-passing is possible with this particular design.

In the r.f. amplifier using conventional tubes, a simple partition is again useful. The tube socket may be mounted on that side of the partition which faces the detector circuit or it may be mounted in the base in the usual manner.

### The Superheterodyne Receiver

● While the superregenerative receiver has unique and unparalleled advantages in the matter of discrimination against ignition and similar noises, a.v.c. action and extreme sensitivity, it does suffer from severe lack of selectivity. R.f. amplifiers ahead of the superregenerative detector provide an improvement in selectivity but the improvement is naturally very slight.

The rapid improvement, during the last year or so, in the stability of amateur u.h.f. transmitters has made it possible to advance the receiving technique by using the superhet type receiver. With the superhet it is immediately possible to provide a high order of selectivity and, in the more advanced superhets, a signal-noise ratio more favorable than that obtained in the superregenerative receiver. The superhet receiver is, though, very much more complex and costly than the superregenerative type and in its really effective forms can only be used to receive transmissions substantially free from frequency modulation. It is possible, of course, to provide the superhet with a very broad intermediate frequency amplifier in order to allow reception from transmitters of the simple modulated-oscillator type. In doing this, however, performance is greatly sacrificed and

the receiver, with all its complications, may not justify its existence.

Since a great many amateurs already own a superhet high frequency receiver (or possibly a broadcast receiver of good sensitivity) and since these receivers serve admirably as the i.f. amplifier for an u.h.f. receiver, many workers will prefer to build their u.h.f. superhets in two sections — a converter unit serving to change the signal frequency to a much lower one, and an i.f. unit working on the lower frequency. A receiver built in this fashion and using a good high frequency or broadcast frequency receiver as the i.f. will, of course, have high selectivity and will be useful only for receiving signals from the better u.h.f. transmitters. Should this be considered a serious limitation, a special broad i.f. amplifier may be built to operate in conjunction with the converter.

Probably the most serious weakness of the conventional superhet is its high response to undamped interference such as that caused by the ignition system of automobiles. There are two practical methods of reducing this trouble. One is in the use of a double frequency i.f. amplifier having a superregenerative final detector (such an amplifier is described later in this Chapter). The other alternative is in the use of one of the noise silencer methods described in Chapters Six and Seven. The

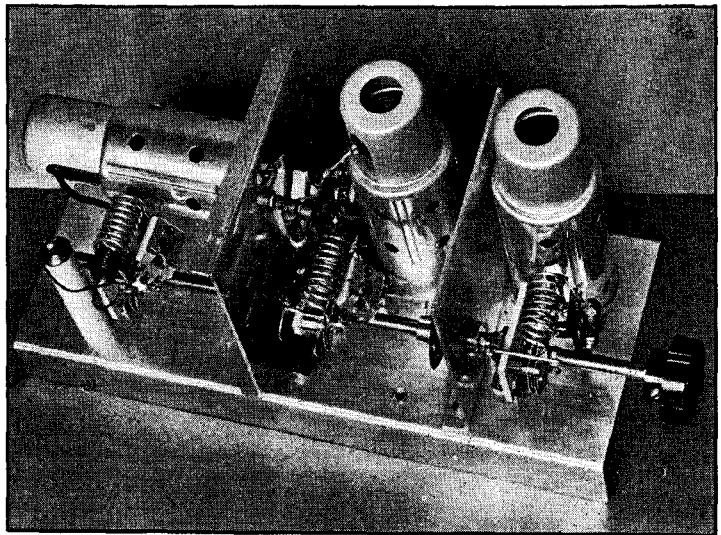
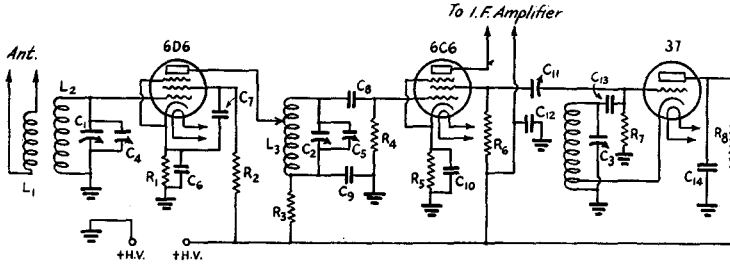

FIG. 1315 — THE GLASS-TUBE CONVERTER UNIT

The chassis is of folded aluminium and measures 10 by 4 by 1 inches. The partitions are  $3\frac{3}{4}$  inches high. The unit is designed to be mounted behind the same panel as the intermediate frequency amplifier which, as suggested in the text, may well be a broadly tuning broadcast receiver. Needless to say, a good vernier dial will be essential on the converter.



**FIG. 1316 — A GLASS-TUBE INPUT CONVERTER SUITABLE FOR THE 56-MC. SUPERHETERODYNE**

- L*<sub>1</sub> — Seven turns of No. 16 enameled wire with very slight turn spacing. Inside diameter  $\frac{3}{8}$  inch.
- L*<sub>2</sub>, 3, 4 — Each eight turns  $\frac{1}{16}$ -inch inside diameter of No. 14 tinned wire. Turns spaced to occupy one inch.
- C*<sub>1</sub>, 2, 3 — 15  $\mu$ fd. Cardwell Trim-Air condensers.
- C*<sub>4</sub>, 5 — National M30 mica padding condensers.
- C*<sub>6</sub>, 7 — .002  $\mu$ fd. midget fixed condensers.
- C*<sub>8</sub> — 100  $\mu$ fd. midget condenser.
- C*<sub>9</sub> — .001  $\mu$ fd. midget condenser.
- C*<sub>10</sub> — .01  $\mu$ fd. paper-type condenser.
- C*<sub>11</sub> — National M30 padding condenser.
- C*<sub>12</sub> — .01  $\mu$ fd. paper-type condenser.
- C*<sub>13</sub> — 100  $\mu$ fd. midget condenser.
- C*<sub>14</sub> — .001- $\mu$ fd. midget condenser.
- R*<sub>1</sub> — 300-ohm half-watt resistor.
- R*<sub>2</sub> — 100,000-ohm half-watt resistor.

- R*<sub>3</sub> — 2000-ohm half-watt resistor.
- R*<sub>4</sub> — 1-megohm half-watt resistor.
- R*<sub>5</sub> — 50,000-ohm half-watt resistor.
- R*<sub>6</sub> — 100,000-ohm half-watt.
- R*<sub>7</sub> — 50,000-ohm half-watt.
- R*<sub>8</sub> — 25,000-ohm half-watt.

Experiment with values of *C*<sub>11</sub>, *R*<sub>5</sub> and *R*<sub>8</sub> may be necessary to get most effective converter operation.

When the output of the converter is to feed into the antenna-ground terminals of a broadcast chassis, a transformer should be connected between the output of the 6C6 and the broadcast receiver input. The primary may be 70 close-wound turns of No. 30 d.s.c. wire on a 1" diameter former tuned with a 150  $\mu$ fd. mica padding condenser. The secondary winding, wound close to the "B plus" end of the primary, should be about 20 similar turns. The optimum size will depend on the individual broadcast set used.

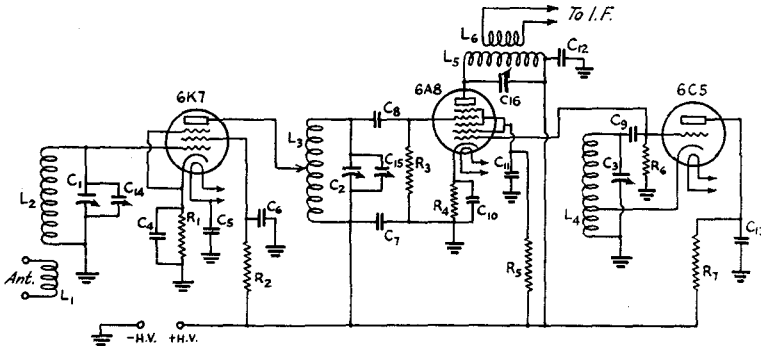

**FIG. 1317 — A SUPERHET CONVERTER USING METAL TUBES**

- L*<sub>1</sub> — Four turns of No. 18 enameled wire  $\frac{3}{8}$ -inch diameter mounted inside grounded end of *L*<sub>2</sub>.
- L*<sub>2</sub>, 3, 4 — Five turns of No. 14 $\frac{1}{2}$ -inch inside diameter with turns spaced diameter of wire. These are for the 60-mc. band — this converter is not recommended for 112-mc. working. The plate tap on *L*<sub>3</sub> is about 1 $\frac{1}{2}$  turns from the grid end but should be adjusted to give optimum performance. The tap on *L*<sub>4</sub> is approximately 1 $\frac{1}{2}$  turns from the grounded end.
- L*<sub>5</sub> — 70 close-wound turns of No. 30 d.s.c. wire on 1-inch diameter former for operation with a 1600-ke. i.f.
- L*<sub>6</sub> — 18 turns of similar wire wound at the end of *L*<sub>5</sub> which connects to *C*<sub>12</sub>.
- C*<sub>1</sub>, 2, 3 — National 15  $\mu$ fd. Ultra-Midget condensers, their shafts connected with flexible couplings.

*C*<sub>4</sub>, 5, 6 — .001  $\mu$ fd. midget fixed condensers. A .01 tubular type condenser in parallel with *C*<sub>6</sub> may be found useful in case of a tendency for the r.f. tube to oscillate.

- C*<sub>7</sub> — 500  $\mu$ fd. midget.
- C*<sub>8</sub>, 9 — 100  $\mu$ fd. midgets.
- C*<sub>10</sub>, 11, 12 — .01  $\mu$ fd. tubular type condensers.
- C*<sub>13</sub> — .001  $\mu$ fd. midget.
- C*<sub>14</sub>, 15 — National M30 mica trimmer condensers.
- C*<sub>16</sub> — 150  $\mu$ fd. mica trimmer.
- R*<sub>1</sub> — 400-ohm half-watt.
- R*<sub>2</sub> — 100,000-ohm half-watt.
- R*<sub>3</sub> — 1 megohm half-watt.
- R*<sub>4</sub> — 300-ohm half-watt.
- R*<sub>5</sub> — 50,000-ohm one-watt.
- R*<sub>6</sub> — 50,000-ohm half-watt.
- R*<sub>7</sub> — 10,000-ohm half-watt.

The output i.f. transformer in the converter illustrated was adapted from a midget diode transformer originally designed for 465-ke. operation.

# . . . Receivers for the Ultra-High Frequencies

latter procedure is very much to be preferred in a receiver having a high-gain and high-selectivity i.f. amplifier.

The designs for u.h.f. superhet converters which follow are presented with the intention of giving a general idea of present practice. They may be used in conjunction with some existing receiver as the i.f. or they may be combined on the same chassis with a special i.f. amplifier. The converter units will remain the same in either case.

## Superhet Converters for U.H.F. Work

● Fig. 1316 is the circuit of the converter unit illustrated in Fig. 1315. It is designed for use with a broadcast receiver operating as the intermediate frequency amplifier and contains a preselector, a first detector and its companion oscillator. The illustration of the converter shows the manner in which the r.f. amplifier is mounted horizontally in order that the connection between the amplifier plate and the grid circuit of the detector may be kept as short as possible, and in order to facilitate the important business of isolating the grid and plate circuit of the r.f. tube. It will be noted that screen-grid injection is used in the first detector. It is obviously possible to exploit other methods of coupling the oscillator either to the control grid or the suppressor grid of the 6C6. A review of the general considerations in converter design given in Chapter Six will reveal almost endless possibilities in the way of

circuit arrangement. Because the screen of the detector is connected across the tuned circuit of the oscillator, this circuit is loaded somewhat by the screen-to-ground capacity. Condensers  $C_4$  and  $C_5$  serve to load the two other tuned circuits in similar fashion in order that the three circuits will track. Additional precautions would have to be taken in order to secure perfect tracking over a wide range of frequencies, but with the arrangement shown it is readily possible to obtain effective tracking over the 56- to 60-mc. band.

## A Metal-Tube Superhet Converter

● Figs. 1317 and 1319 illustrate a compact converter which has been used in conjunction with a midget superhet broadcast receiver as i.f. amplifier to give an excellent performance in routine reception. Fig. 1317 reveals a conventional 6K7 r.f. amplifier coupled to the grid circuit of the mixer by a direct connection. The 6A8 mixer, with the oscillator voltage fed to the No. 1 grid, feeds an output transformer tuned to the frequency at which the broadcast set or high frequency receiver is to be tuned. The oscillator itself is of the grounded plate type. While having rather poor stability it performs satisfactorily once the rig has passed the "warm-up" period.

The converter is assembled on a folded aluminium channel measuring  $7\frac{3}{4}$  by 3 by 1 inch, the partitions between the sections of the circuit being 3 inches square. In this particular

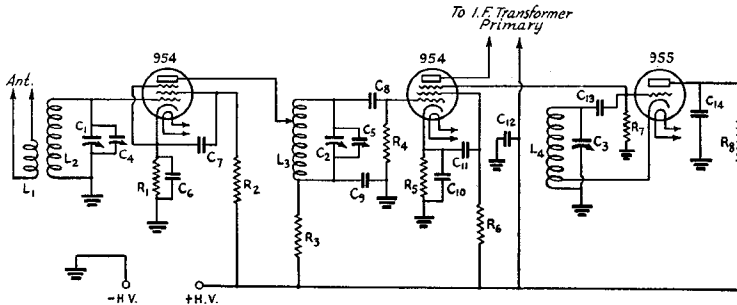

FIG. 1318 — WIRING OF THE ACORN INPUT UNIT

- $L_1$  — Seven turns of No. 15 enamelled wire  $\frac{1}{2}$ -inch inside diameter. Very slight spacing between turns.
- $L_2, 3, 4$  — Each eight turns of No. 14 bare or tinned wire  $\frac{1}{2}$ -inch inside diameter with turns spaced to occupy one inch. The best position for the plate tap on  $L_3$  is usually 3 or 4 turns down from the grid end of the coil. Cathode tap on  $L_4$  at  $1\frac{1}{2}$  or 2 turns from the grounded end of coil. These coils are for 56-mc. operation.
- $C_1, 2, 3$  — National Type UMA condensers with four stator and five rotor plates. These are unnecessarily large for the 56- to 60-mc. band but give convenient coverage of about 4 mc. on each side of the amateur band.
- $C_4, 5$  — National Type M30 padding condensers (Max.

- capacity 30  $\mu\text{fds.}$ ).
- $C_6, 7$  — 500  $\mu\text{fds.}$  fixed midget condensers.
- $C_8$  — 100  $\mu\text{fds.}$  fixed midget condenser.
- $C_9$  — 500  $\mu\text{fds.}$  fixed midget.
- $C_{10}, 11, 12$  — .01  $\mu\text{fd.}$  400-volt paper-type condensers.  $C_{10}$  may be low-voltage type.
- $C_{13}$  — 100  $\mu\text{fds.}$  fixed midget condenser.
- $C_{14}$  — 1000  $\mu\text{fds.}$  fixed midget.
- $R_1$  — 1500-ohm half-watt fixed resistor.
- $R_2$  — 100,000-ohm half-watt fixed resistor.
- $R_3$  — 2000-ohm half-watt fixed resistor.
- $R_4$  — 1-megohm half-watt fixed resistor.
- $R_5$  — 2000-ohm half-watt fixed resistor.
- $R_6$  — 100,000-ohm half-watt fixed resistor.
- $R_7$  — 50,000-ohm half-watt fixed resistor.
- $R_8$  — 100,000-ohm half-watt fixed resistor.

set-up the i.f. output transformer is mounted on the side of the chassis. In this way the leads from the plate circuit of the mixer are made as short as possible. Coils  $L_2$ ,  $L_3$  and  $L_4$  are soldered directly to the tuning condenser lugs while  $L_1$  is mounted on lugs in a small strip of

a mixer and the superior stability of the 955 as an oscillator. The unit shown in Figs. 1301 and 1318 may therefore be considered as the last word in superhet converter practice at least as far as the selection of tubes is concerned.

The circuit used is very similar to that of Fig. 1317, differing only in the method of injecting the oscillator voltage into the mixer. As in the previous example, parallel trimmer condensers are used across the r.f. and mixer grid circuits to allow adjustment for good tracking of the condenser gang.

The unit is assembled on a folded aluminium chassis  $7\frac{3}{4}$  by 3 by 1 inch, the partitions on which the tube sockets are mounted being 3 by 3 inches. In the converter illustrated, normal isolantite tube sockets are used. It is firmly suggested, however, that the new metal National XMA socket be used for the r.f. and mixer tubes since in this way, by-passing may be made much more effective. In assembling

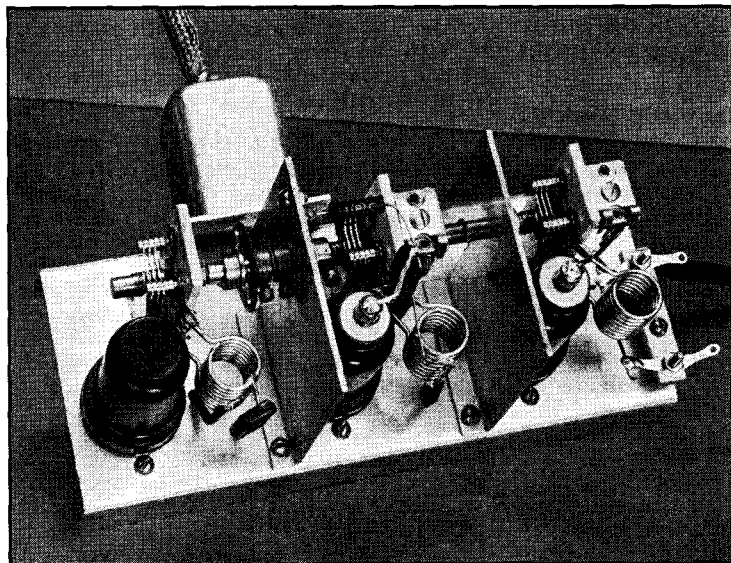

FIG. 1319 — A GENERAL VIEW OF THE U.H.F. CONVERTER USING METAL TUBES

From left to right the tubes are oscillator, mixer and r.f. amplifier. The appendage on the rear is the output i.f. transformer from the mixer. In its final form the converter would be fitted with a good vernier dial.

Victron. The trimmer condensers  $C_{14}$  and  $C_{15}$  are located alongside the tuning condenser and held in place merely by the No. 14 gauge wires which connect them in the circuit. The various by-pass condensers are mostly of the very small midget type since space under the base is somewhat limited. In other respects, the unit follows normal practice in construction and wiring. Naturally, the converter must be fitted with a good vernier dial in the finished receiver.

### A Converter Using Acorn Tubes

● The converters so far described are satisfactory for the 56-mc. band but quite limited in their performance on the higher frequencies. The amateur who plans to build a superhet for 112 mc. and higher should therefore think only in terms of the Acorn tube for the converter unit. Even in a converter designed solely for 56 mc., of course, the Acorn tubes will give a far better performance than conventional tubes because of the much higher gain of the r.f. stage, the better performance of the 954 as

the unit it will be found that there is very little room to spare and that the relative placement of tube sockets, tuning condensers and other components must be given careful consideration. This compact type of assembly, while making construction slightly more difficult, is of great advantage in allowing very short leads throughout the r.f. circuits. All condensers in the circuit except  $C_{12}$  are mounted above the base and directly connected to the various socket terminals concerned.

It will be found that complete freedom from oscillation in the r.f. stage may be had even with no shielding other than the vertical partitions. This only applies, of course, when the antenna is connected. On the other hand, an additional shield cover over the whole unit is desirable if only to protect it from dust.

### Adjusting the U.H.F. Converter

● Amateurs unfamiliar with normal procedure in aligning superhet receivers will doubtless have some difficulty with the u.h.f. converters.



## . . . Receivers for the Ultra-High Frequencies

The process is greatly simplified if an i.f. amplifier in the form of a broadcast or high frequency superhet is already available. For the moment we will assume this to be the case. The first step is to set the i.f. amplifier at the frequency chosen and connect to it the output transformer from the mixer in the converter. The connecting leads may be of twisted pair but should run in a piece of flexible cable shield grounded to both the chassis of the converter and the ground terminal of the receiver serving as i.f. amplifier. Now the tuning condenser in the output transformer from the mixer should be tuned until the noise output from the receiver rises to a peak. This may be done even though the converter is not yet lined up. At this stage, the oscillator tuning condenser should be freed from the two others in the gang and with the latter condensers set at about half scale the oscillator condenser should be rotated until there is a sudden increase in noise output. Two settings should be found at which the noise increases — each one differing in frequency from the resonant point of the r.f. amplifier circuits by an amount equal to the i.f. frequency. In the converters described, the higher of these two oscillator frequencies should be chosen. At this point the trimmers across the first two tuning condensers should be adjusted so that the three tuning condensers come into line. The adjustment may be repeated at both ends of the scale to make certain that the three circuits stay in line across the full tuning range. The procedure is greatly facilitated if a modulated u.h.f. test oscillator is available. Even by using background noise alone, however, quite accurate alignment is possible.

### The I.F. Amplifier Problem

● As we have already stated, a conventional high frequency superhet or broadcast receiver is eminently satisfactory as the i.f. amplifier if high selectivity can be tolerated. The most satisfactory frequency on which to operate is somewhere in the neighborhood of 1500 kc. At this frequency trouble from image interference will not be severe if the r.f. stage in the converter is adjusted correctly. The ideal set-up is, of course, one in which the receiver used as i.f. amplifier is fitted with an effective noise silencer as well as effective a.v.c. Comprehensive details of both of these features will be found in Chapters Six and Seven.

In instances where the selectivity of the complete superhet must be of a low order to allow reception of frequency modulated or generally unstable transmissions, some sort of

special i.f. amplifier is essential. One solution is to use a good ham receiver of the simple r.f.-detector-audio type. An SW3 or its equivalent, tuned to, say, 1600 kc. makes quite a satisfactory amplifier. With the detector regeneration control set for highest sensitivity, the overall gain is quite respectable. An alternative is an old-time tuned r.f. broadcast receiver. Such receivers can be picked up for a few dollars at most radio stores and work out splendidly. The remaining alternative is to build a special i.f. amplifier with i.f. transformers operating at 4000 kc. or higher. Such transformers are now available. The general design of the amplifier, its a.v.c. circuits and its noise silencer would follow exactly the principles laid down in Chapter Six.

### An I.F. Amplifier with Superregeneration

● An unconventional solution of the i.f. amplifier problem is that described in *QST* for November and December 1935. The complete receiver incorporating this type of i.f. amplifier, known as the Superinfragenerator, has since shown its merit in practice and is still deserving of consideration.

In this receiver the incoming ultra-high frequency signal frequency is converted in the first detector (or mixer) to an appropriate low first intermediate frequency. This permits the immediate establishment of a desirable order of selectivity. The second detector, instead of giving audio-frequency output converts the i.f. signal to a very much higher frequency suited for thoroughly effective superregenerative action. This second high-intermediate frequency is tremendously amplified and its audio frequency components made audible by the superregenerative 3rd detector. It is then amplified with the conventional audio frequency tube. The receiver therefore consists primarily of three detectors operating on three widely separated frequencies and interconnected with nothing more than appropriate tuned circuits.

### Future Developments

● In describing these odd pieces of representative ultra-high frequency receiving equipment, the idea has been to sketch the requirements for effective working. None of the apparatus can be considered as the ultimate. We would emphasize again that the entire field of ultra-high frequency working is in a state of extreme flux. New developments are appearing almost every day and equipment which is now modern is likely to be superseded in the very early future.

# 14

## ***Ultra-High-Frequency Transmitters***

### **THE SIMPLEST CIRCUITS—FREQUENCY STABILITY CONSIDERATIONS—LINEAR OSCILLATORS—SHORT-LINE-CONTROLLED OSCILLATORS—OSCILLATOR-AMPLIFIER TRANSMITTERS**

**T**RANSMITTER practice on the ultra-high frequencies differs quite considerably from that followed on the lower frequencies. One important reason for this is that conventional transmitting tubes are very poor amplifiers at frequencies of 56 mc. or above. It is possible to use a relatively low-frequency controlling oscillator and to follow it with a series of harmonic amplifiers until the desired ultra-high frequency is reached. However, the efficiency obtained in the amplifiers at the ultra-high frequency end of the transmitter is usually low and such a set-up represents a very considerable expenditure of time and money. In the early days of ultra-high frequency working, common practice was to use a simple oscillator circuit for the transmitter, then modulating the oscillator directly. Transmitters of this type, indeed, are still widely used today but, unless special precautions are taken, they exhibit very serious frequency modulation which causes their signal to occupy an unnecessarily wide band of frequencies and which prohibits the use of even a reasonably selective receiver. The trend, today, is toward the use of stabilized oscillators of one form or another. The best stations employ a crystal-controlled oscillator but reasonable freedom from frequency modulation can be obtained by using resonant lines as the frequency control elements and by using oscillator-amplifier combinations.

Before proceeding with the details of actual transmitting circuits, it would be well to outline the frequency bands in which these transmitters are to operate and to submit some general suggestions with respect to the problem of determining the frequency at which the transmitter is operating.

#### **Finding the Bands**

● On the ultra-high frequencies the amateur has available the territory between 56 and 60

mc. and also all the frequencies higher than 110 mc. In order to facilitate contact and communication in the enormously extensive territory higher than 110 mc., however, it has been suggested that the amateur endeavor to operate in bands related harmonically with the 56-mc. band. The so-called ultra-ultra high frequency bands to which particular attention is being given are therefore 112 to 120 mc.; 224 to 240 mc. and 448 to 480 mc.

In mentioning these bands we have so far adhered to the usual practice of stating the frequencies involved. This practice, however, is prone to be very inconvenient when speaking of and working with the ultra-high frequencies. Antennas, linear tuning rods, reflectors and directors are all to be measured in terms of wavelength and it is most inconvenient to be obliged to convert frequency to wavelength before proceeding with such measurements. Then, the most practical means of frequency determination on the ultra-high frequencies is by actually measuring the wavelength directly from a standing wave on wires. It is obviously a handicap to be obliged to convert direct measurements so obtained back to frequency.

For these reasons we will find it desirable to make use of wavelength very frequently in this chapter and can only hope that the reader will find it reasonably simple to acquire the habit of thinking in terms of frequency and wavelength simultaneously.

The 56-mc. band covers from 5.357 to 5 meters. This means that the harmonically related 112-mc. band will be from 2.678 to 2.5 meters while the next band down — the 224-mc. band — will be from 1.339 to 1.25 meters.

The future will certainly see amateur activity on the frequencies higher than these but, at the moment, most of the interest is concentrated in exploring the wide "wastes" between 5 and 1.25 meters.

# Ultra-High-Frequency Transmitters

The methods of frequency measurement and checking described in Chapter Seventeen are, generally speaking, unsuited for the ultra-high frequencies. Fortunately, simpler (though probably less accurate) methods are available.

The simplest method is merely to cut the antenna wire to 95 per cent of the actual wavelength desired, then tuning the transmitter until the antenna is operating most effectively. This scheme is, of course, extremely approximate and would serve only as a preliminary measure.

The next simple scheme is to compare the frequency of one's own transmitter by tuning it on the receiver and comparing the setting with other stations of known wavelength. This is readily possible in districts where plenty of signals are available for the purpose but at present would be impractical on the  $2\frac{1}{2}$ - or  $1\frac{1}{4}$ -meter bands. On the latter bands, or even on 5 meters, the problem is readily solved if a linear type oscillator is used. With this type of oscillator (to be described later) the wavelength can be measured directly from the rods which constitute the tuning circuit.

For the very short waves, probably the most practical method involves the use of two parallel wires — known as Lecher wires — on which standing waves may be measured directly. Such a Lecher system may be set up readily and forms a valuable addition to the ultra-high frequency worker's equipment.

A typical Lecher system consists of two No. 18 bare copper wires spaced about two inches and mounted on stand-off insulators on a length of board. The wires should be several wavelengths long. The wires are left free at one end while at the other they are connected to a one- or two-turn coupling coil of about the diameter of the tank coil of the transmitter. This coupling coil is placed near the transmitter coil. In operation, a sliding bridge — consisting of a piece of stiff bare wire on the end of a two-foot wooden dowel — is run slowly down the length of the wires until a point is reached where the oscillator plate current makes a sudden fluctuation. The point is marked. The bridge is then moved farther down the wires until a second node is located. This also is marked. The same procedure is then followed to locate a third node. At this stage, the distance between each pair of marks is measured. If the Lecher system is operating correctly and if it is mounted well clear of surrounding objects, the distances will all be the same and will represent quite accurately one half of the wave-length being measured. An alternative sliding bridge — useful when the oscillator has

plenty of output — is a flashlamp bulb with wires soldered to its contacts. These wires are hooked over the wires of the Lecher system and the lamp moved along until the various points are located at which the lamp lights brightest. The points will be extremely critical.

The same general procedure may be used to calibrate a receiver — the indication in this case being obtained by the receiver going out of oscillation as the bridge passes over the various nodes.

Once the approximate calibration has been obtained in this way, it can be readily checked by comparing harmonics produced by oscillators on harmonically related lower frequency bands.

## Simple Oscillator Circuits

● One of the simplest and most practical circuits for experimental work is that shown in Fig. 1401. It is the type of circuit which can be set up in quick time and hence is of especial value to the experimenter. However, in common with all similar circuit arrangements, the

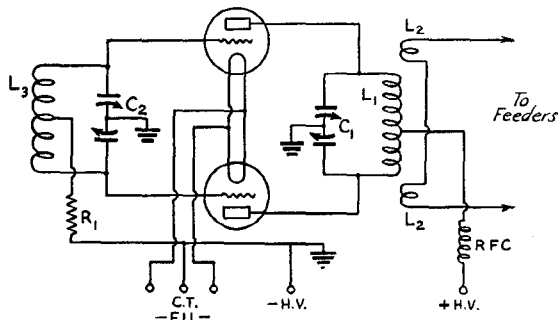

FIG. 1401 — A TYPICAL TUNED-GRID TUNED-PLATE OSCILLATOR CIRCUIT SUITED FOR THE LOW-POWERED TRANSMITTER ON THE 56- AND 112-MC. BANDS

- L<sub>1</sub>* — 2 or 3 turns of  $\frac{1}{8}$ -inch copper tubing or No. 12 wire 2 inches diameter. The size depends considerably on the type of tubes used.
- L<sub>2</sub>* — A single turn 2 inches diameter at each end of *L<sub>2</sub>*. The turns should be wound in the same direction — as if they were merely two turns spaced very widely.
- L<sub>3</sub>* — Similar to *L<sub>1</sub>* or slightly larger. For 112 mc. work, the number of turns should be halved and spaced to occupy the same length as 56-mc. coils. The same number of turns may be used on 112 mc. as on 56 if the diameter is reduced to  $\frac{1}{8}$  inch.
- C<sub>1</sub>* — Split stator condenser with 35 or 50  $\mu$ fd. per section and spacing to suit voltage used. Receiver type condensers are usually suitable for voltages up to 350.
- C<sub>2</sub>* — Similar condenser of receiver type.
- R<sub>1</sub>* — Between 10,000 and 50,000 ohms depending on tubes and voltages used.
- R.F.C.* — Approximately 30 turns of No. 30 wire on  $\frac{1}{4}$ -inch former. Most of the standard r.f. chokes are completely effective.

# The Radio Amateur's Handbook . . . . .

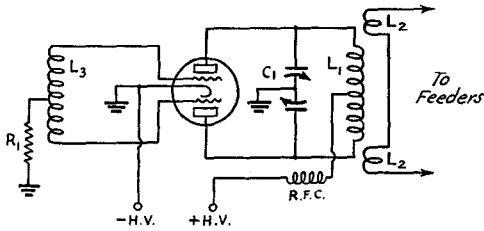

FIG. 1402 — ILLUSTRATING THE USE OF A FIXED-TUNE GRID CIRCUIT

Values of the various components correspond with Fig. 1401 except for the grid coil. The size of this coil depends very greatly on the type of tubes used. 10 turns of No. 16 1/2-inch diameter will serve for the preliminary set-up. The spacing of the turns may be varied until the oscillator plate current (unloaded) is lowest at the desired frequency.

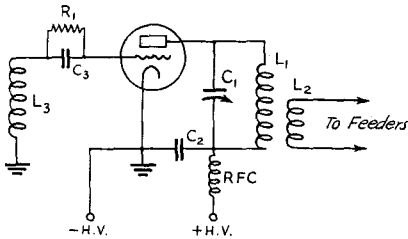

FIG. 1403 — A SINGLE-TUBE CIRCUIT OF STANDARD TUNED-GRID TUNED-PLATE TYPE

A tuning condenser of 15 or 35  $\mu\text{fd.}$  capacity may be used. The coils will be slightly smaller than those specified for the push-pull circuits.

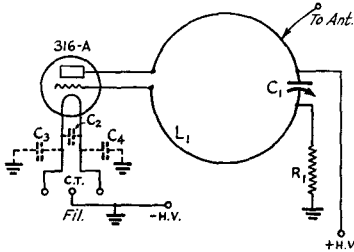

FIG. 1404 — A SINGLE-TUBE OSCILLATOR CIRCUIT WHICH IS PARTICULARLY USEFUL FOR EXPERIMENT ON FREQUENCIES ABOVE 112 MC.

In a typical transmitter using this circuit for 224-mc. operation with the W.E. 316-A tube the following values were used:

- L<sub>1</sub> — Single split turn 3 1/4 inches diameter of No. 14 bare copper wire.
- C<sub>1</sub> — 15  $\mu\text{fd.}$  National Ultra-Midget condenser.
- C<sub>2</sub>, 3, 4 — Filament by-pass condensers provided by filament mounting strips, see photograph.
- R<sub>1</sub> — 20,000 to 50,000-ohm 10-watt resistor. 30,000 ohms was the value used in most of the work described.

Successful operation will be greatly facilitated by mounting the transmitter on a foundation of copper gauze or sheet.

The antenna used is of the single-wire feed type discussed in Chapter Sixteen.

inherent stability is of a low order. When modulation is applied, the output frequency will change in accordance with the modulation voltage and, as a result, the signal will occupy a wide band of frequencies. The circuit is therefore not recommended for ultra-high frequency communication purposes except in instances where the equipment *must* be kept as compact and light-weight as possible.

It will be seen that the circuit is the old "tuned-grid tuned-plate" which was so widely used on the lower frequencies many years ago. A variation of it is shown in Fig. 1402. In this case the grid coil is made large enough to resonate at the desired frequency without any parallel tuning condenser. This arrangement is convenient for very compact transmitters in which the number of components must be kept at a minimum. In the first circuit filament type tubes are shown, while in the second, heater type tubes are indicated. The filament wiring arrangement is, of course, interchangeable.

Fig. 1403 shows a typical single-tube circuit of the same general type. It is a useful circuit in very small transmitters or oscillators rigged for experimental work. It has been almost superseded, however, by the push-pull circuits — particularly those in which twin-triode tubes are used.

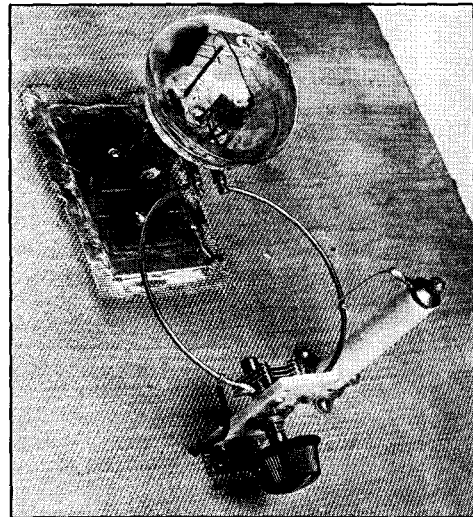

FIG. 1405 — A SIMPLE TRANSMITTER USING THE W.E. 316A TUBE FOR 224 MC.

The extremely low tube capacities and the low inductance of its leads allow the use of a tank circuit on 1 1/4 meters about the same size as that necessary on 5 meters with a conventional tube. The filament by-pass condenser is made from copper strips separated by thin mica. It serves also as the mounting for the tube.

# . . . . . Ultra-High-Frequency Transmitters

A further simple circuit particularly suited for single-tube operation is that shown in Fig. 1404. This particular circuit is suited for experimental work, with conventional tubes, on frequencies even as high as 224 mc. The frequency stability of this type of circuit, though, is also very poor.

This transmitter was described in detail in the September, 1936, *QST*.

In general, any of the conventional self-excited oscillator circuits may be used for u.h.f. work. We include these four examples because they have been shown to be particularly effective in practice. None of them, however, are suggested for use in the modern fixed station where appreciable power is used. Such transmitters are capable of producing severe interference and cannot be received satisfactorily with selective receivers.

### Linear Oscillator Circuits

● The circuits just described, and many similar to them, are unsatisfactory simply because their frequency stability is so poor. Another type of circuit, admirably suited for all the bands mentioned, and having considerably greater inherent frequency stability, is that of Fig. 1406. It is one of a large group of so-called "linear" oscillators. In Fig. 1406, the conductors  $L_1$  and  $L_2$  are made of such dimensions that the entire length of each conductor —

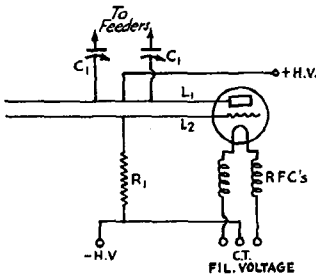

FIG. 1406 — AN OSCILLATOR CIRCUIT SUITED FOR THE VERY HIGH FREQUENCIES

- $L_1, L_2$  — Copper rods or tubes slightly less than a half-wave long. Tubing  $\frac{1}{2}$ -inch outside diameter spaced 1 inch between centers is suggested though smaller or larger conductors will serve.
  - $C_1$  — Feeder tuning condensers. Three-plate midgets would be satisfactory for  $2\frac{1}{2}$  meters or below. Condensers several times this capacity would serve for 5 meters.
  - $R_1$  — Grid-leak of resistance and power rating to suit oscillator tube. 25,000 ohms is a good average value.
  - RFC's — About 25 turns of No. 14 wire  $\frac{1}{2}$ -inch diameter with turns spaced the diameter of the wire. These chokes are absolutely essential.
- Almost any of the usual triodes will operate in this circuit down to at least  $2\frac{1}{4}$  meters. The Type 800 or W.E. 304-A are suggested for satisfactory performance at  $1\frac{1}{4}$  meters.

including the elements and leads within the tube — correspond to a half wavelength. The plate and grid feeds are then connected at the nodal point in the electrical center of the system. The conductors may be made of No. 14 wire but a great improvement in performance is made possible by using large diameter copper

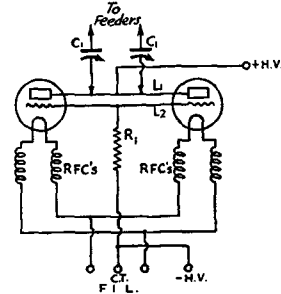

FIG. 1407 — A PUSH-PULL VERSION OF THE LINEAR OSCILLATOR

The same values may be used as given under Fig. 1406. The length of the rods must be reduced, however, to allow for the loading effect of the second tube.

tubing — the two conductors being spaced approximately the diameter of the tubing.

Several methods of coupling the feeder system are possible. That indicated is one possibility. In this case, the tuned feeders of a Zepp system are clipped on the plate rod, one on each side of the nodal point. Variation of the spacing of the two clips then permits variation of the coupling to the feeder. Untuned feeders may be attached in the same manner, the spacing of the clips being varied to give the necessary impedance match.

In this type of oscillator, the adjustment of the length of the rods is the one very important matter. It is probably a good scheme to start out with rods a full half-wave long, then cutting them down until the desired wavelength is reached. The actual length of the rods will depend upon the type of oscillator tube used.

The mounting of the rods is another important matter. Probably the simplest method is to support them between two stand-off insulators on a strip of good insulating material. The support should preferably be at the nodal point.

### A Push-Pull Linear Oscillator

● The circuit of Fig. 1407 shows how the linear oscillator may be adapted for push-pull working. Instead of having one end of the half-wave lines open, they are connected to the grid and plate of a second tube. This means, of course, that the actual length of the rods will be decreased to allow for the loading provided by

# The Radio Amateur's Handbook . . . . .

the second tube. The full length of each rod will be twice the distance from the node to the tube terminals in Fig. 1406. The nodal point, where plate and grid feeds are attached, will now be in the center of the system. The antenna feed methods may be the same as those previously mentioned.

## Setting up a Linear Oscillator

● The construction and tuning of transmitters of the type just mentioned is very simple. The only essential need is to develop the habit of visualizing the voltage distribution along the rods so that the actual operating conditions in the circuit can be determined rapidly. The most suitable tubes for these circuits, and for the  $2\frac{1}{2}$ - and  $1\frac{1}{4}$ -meter bands, are probably the 800 and the W.E. 304B. Other tubes such as the 45, 10 or 37 have been shown to be effective but a little more difficulty may be had in obtaining stable operation and reasonably long tube life.

The use of a plate current meter is, of course, essential. If the circuit is oscillating, this meter will show current fluctuations when the rods are touched with a pencil or screw-driver at

points other than the voltage nodes. This very method, indeed, is probably the best one to reveal the actual location of the nodes. Another practical way of locating the best position for the plate and grid feed clips is to move the clips until the plate current drops to a minimum value.

## A Three-Band Transmitter

● Fig. 1408 illustrates a transmitter of this general type suited for operation on the 5,  $2\frac{1}{2}$ - and  $1\frac{1}{4}$ -meter bands. It is similar to the arrangement of Fig. 1406, being identical, in fact, when the set is operated on  $2\frac{1}{2}$  meters. The plate and grid conductors are made a full-wave long at  $1\frac{1}{4}$  meters and the circuit will oscillate at that wave length when the plate and grid-feet clips are connected one quarter-wave (at  $1\frac{1}{4}$  meters) from the tube elements. Sliding the feed clips out near the center of the rods will put them one quarter-wave (at  $2\frac{1}{2}$  meters) from the open end and the system will then operate at  $2\frac{1}{2}$  meters. For 5-meter operation, the feed clips are run down to the ends of the rods and a by-pass condenser is clipped across them. Since the entire rod length is one quarter-wave at 5 meters the node will be at the far end and the system will oscillate at 5 meters. It will be necessary, of course, to change the location of the antenna feeder clips when changing from one band to another. On the  $2\frac{1}{2}$ - and  $1\frac{1}{4}$ -meter bands they may be on either side of the plate feed connection. On 5 meters, one feeder may be clipped on the plate rod near the feed end, the other feeder opposite it on the grid rod.

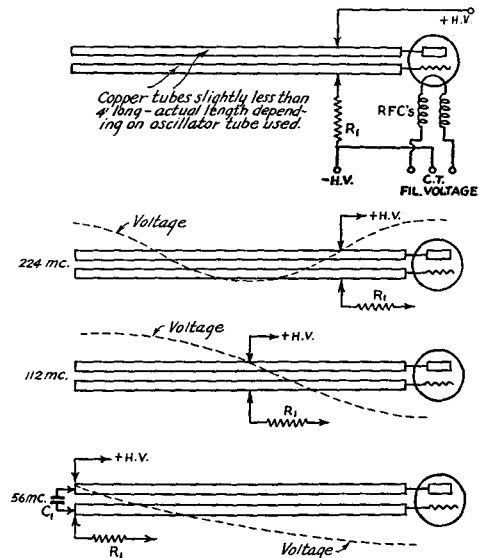

FIG. 1408 — A THREE-BAND ULTRA-HIGH-FREQUENCY TRANSMITTER

The rods are of  $\frac{1}{2}$ -inch copper tubing spaced 1 inch center to center. Their length is slightly less than a full wave at  $1\frac{1}{4}$  meters. The actual length is determined by the type of tube used. With a W.E. 304-B, the rods are 113 centimeters (about 34 inches) long. They would be slightly shorter for the 800 and most of the smaller tubes. An adjustable bridging condenser of about  $25\ \mu\text{f}$ s. between the grid and plate feed points may be found desirable on 112 and 224 mc.

## Short-Line Control

● In the circuits just discussed, improved stability is made possible by the use of high-Q resonant-line or linear circuits. However, since the tube or tubes in the circuit are attached to the free end of the line, the Q of the complete circuit is considerably less than that of the line by itself. A large family of circuits has been devised in which a very high-Q line is used as the frequency controlling element, so connected into the tube circuit as to avoid any really serious reduction in effectiveness.

The basis of the scheme can best be explained by comparing it with crystal control. In the normal crystal oscillator, the grid circuit consists of the crystal itself, serving as the frequency controlling element. In the short-line controlled oscillator, the crystal is displaced by a high-Q resonant line along which the grid or grids of the oscillator tube or tubes are tapped. The grid connection is made as near to the voltage node of the line as possible, in order to reduce the influence of variations in the

# . . . . . Ultra-High-Frequency Transmitters

tube circuit on the characteristics on the line. Circuits of this general type are quite simple in construction and are capable of providing very excellent frequency stability when the line itself is correctly designed. Assuming that the optimum spacing is used between the conductors of the line, the  $Q$  of the line is proportional to the diameter of the conductor used. It is also interesting to note that  $Q$  is proportional to the square root of the frequency and, unlike conventional tuned circuits, therefore increases with frequency. A line made up of copper tubing of about 4 inches in diameter has, at 60 mc., a  $Q$  of more than 6000. Such a line is therefore capable of providing a selectivity performance comparable with that of a

crystal-controlled oscillator. Tubing of such dimensions is, though, quite expensive, and many amateurs do use conductors of 1-inch diameter or less. Such lines do not provide the highest possible order of selectivity but allow quite a tremendous improvement over oscillators not fitted with this type of frequency control.

## Constructing Resonant Lines

● The lines used for frequency control are of two general types. First there is the open line, consisting of two parallel copper pipes connected together with a heavy jumper at one end and open at the other. The length of the line from jumper to open end is slightly less than

FIG. 1409 — THREE BASIC CIRCUITS FOR THE SHORT-LINE-CONTROLLED OSCILLATOR

The pipes in the grid circuit play the major part in providing frequency stability and the greater their diameter the better. They should be of hard-drawn copper and particular attention should be given to the method of making contact between them at the shorted end.

$L_1$  — Approximately three turns of  $\frac{1}{8}$ -inch copper tubing, turns 2 inches diameter for 56 mc. A single turn for 112 mc. Actual coil size will depend greatly on type of tubes used, arrangement of wiring and type of tuning condenser.

$L_2$  — Each a single turn 2 inches in diameter. They must be wound so that the two turns, though separated, are in the same direction.

$C_1$  — at "A" — split-stator condenser of voltage rating to suit supply used. 15 to 35  $\mu\text{sf}$ d. total effective capacity suitable.

$C_1$  — at "B" and "C" — 15 to 75  $\mu\text{sf}$ d. receiving type condensers. The smaller order of capacity suitable for the highest frequency bands.

$R_1$  — 10,000 to 50,000 ohms depending on type of tubes used.

RFC — Usually necessary only on 112 and 224 mc.

Approximately 15 turns of No. 11 wire  $\frac{1}{2}$ -inch inside diameter for 112 mc. Seven similar turns for 224 mc. Careful adjustment of these chokes in each individual layout is usually necessary.

Allowance must be made for the filament voltage drop in these chokes, especially when the more powerful tubes are used.

It is as well to start out with the grid line a full quarter-wave long, then moving up the bridge and adjusting grid taps until desired frequency is reached. One quarter-wave is approximately four feet for 56-mc. band; two feet for 112-mc. band and one foot for 224-mc. band. The plate lines will be considerably shorter because of the loading effect of the tubes. The same full quarter-wave might well be used at the start, however.

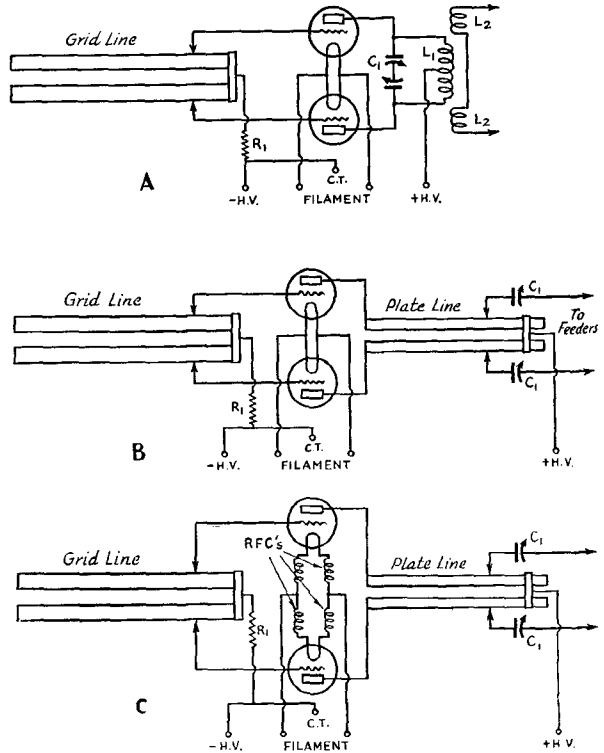

a quarter wave — it would be exactly a quarter wave if it were not for the loading offered by the capacity of the vacuum-tube elements.

The second and more effective type of line is of the concentric type, a small copper pipe or rod being mounted inside a larger pipe and the two connected together at one end. The usual practice is to make the outer conductor slightly longer than a quarter wave and the inner line considerably shorter. A sliding sleeve

over the inner conductor is then used to vary its length and so to tune the circuit. In its original form, this line is rather difficult to handle in practice since free access to the inner conductor cannot be had. Further, large diameter copper tuning or pipe is quite expensive. Both of the problems have been solved in a design for the concentric line suggested by Paul Zottu and detailed in *QST* for September, 1936. In this design the inner conductor is the usual rod or pipe but the outer element is a square-section trough of folded sheet copper. The inner conductor is, of course, readily available for adjustment through the open side of the trough. The use of a square section for the outer conductor and opening one of its sides does not measurably affect the performance. The Zottu trough-type line is destined to see wide use in amateur u.h.f. work.

### Line Spacing

● In determining the spacing of the conductors in both the open and concentric resonant lines, the following ratios should be observed:

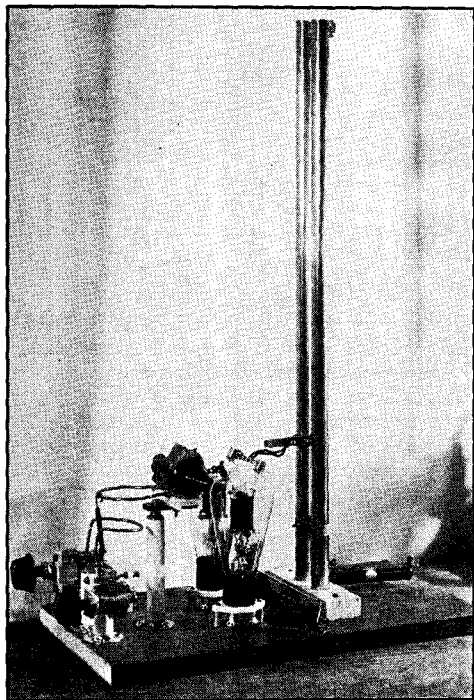

FIG. 1410 — A TRANSMITTER FOR 112-MC. OPERATION USING CIRCUIT "A" OF FIG. 1409

The antenna coil in this case is a single turn. The two series feeder tuning condensers can be seen at the left. Type 800 tubes are shown.

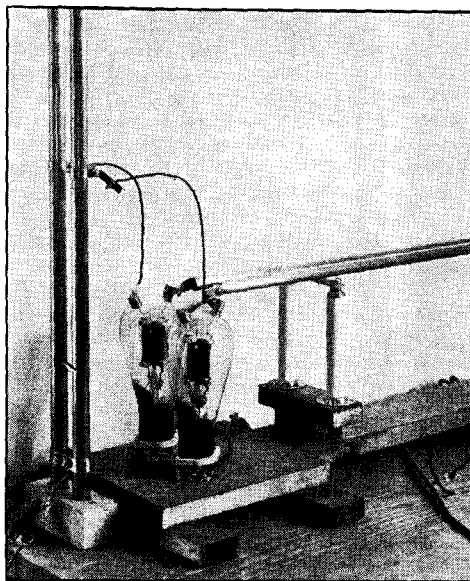

FIG. 1411 — THE TUBE END OF A TRANSMITTER EMPLOYING THE CIRCUIT "B" OF FIG. 1409 AND OPERATING ON 56 MC.

The mounting of the grid line in this example is not ideal because of the long grid leads. It is better, when possible, to drop the line over the edge of the bench in the manner shown in Fig. 1413. While Type 800 tubes are shown, the arrangement is equally suited for tubes of lower power.

$$\frac{b}{a} = 3.6$$

when

$b$  = inner radius of outer conductor in concentric lines, or the spacing between tube centers in open lines.

$a$  = outer radius of inner conductor in concentric lines, or the tube radius in an open line.

This figure of 3.6 is, in practice, not extremely critical. Practical considerations will often require using a figure nearer 3 or 4. In the case of the open line this is the equivalent of saying that the pipes should be spaced slightly less than their own diameter.

In the trough-type line it is sufficient to consider the side dimension as the diameter in the above relationship.

### Practical Open-Line Transmitters

● Fig. 1409 illustrates three practical arrangements of push-pull oscillators employing short-line frequency control with open-type lines. The controlling element, marked "grid line" on the diagram consists of a pair of copper pipes slightly less than a quarter wavelength long and with the pipes spaced approximately their own diameter. The bridge across the



## . . . . . *Ultra-High-Frequency Transmitters*

voltage-node end of the line must be given careful consideration. At this point very large r.f. currents are flowing and it is readily possible to destroy the effectiveness of the line if poor electrical contact exists at this point. For experimental work this bridge may consist of copper strips clamped in place with machine screws (to permit adjustment of the effective length of the line) but a much more effective scheme for the permanent transmitter is to solder or braze the pipes at this point into a

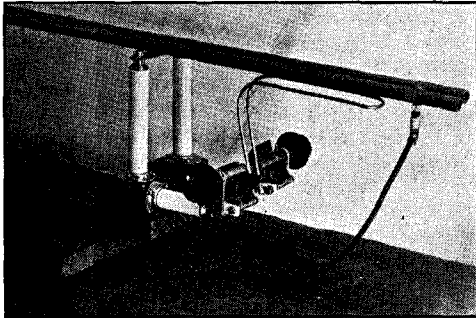

FIG. 1412 — THE FAR END OF THE PLATE LINE OF THE TRANSMITTER SHOWN IN FIG. 1411

*The antenna coupling "hairpin" is mounted on the two series feeder tuning condensers. The high-voltage feed line drops down from the bridge on the line. The hairpin coupling has been found somewhat more convenient to adjust than the sliding contacts shown in Fig. 1409.*

copper plate, then providing sliding extension pieces in the free ends of the pipes to allow adjustment of the length.

In setting up the type of transmitter shown in "A" of Fig. 1409, it is as well to start out with the resonant line a full quarter-wave long. Then, with the grid connected about one-third the line length from the shorted end, the plate tank is tuned until the plate current takes a sharp drop — indicating oscillation. The bridge on the line and the grid taps are then varied until oscillation is obtained at the desired frequency with the lowest possible value of plate current. The oscillator is then coupled to the antenna circuit in the usual manner. The closer the grid taps approach the bridge the greater will be the stability and the longer will the line be for a given frequency. High stability can only be obtained by very careful adjustment of these grid taps.

Considerable improvement in the overall efficiency of this type transmitter can be obtained by replacing the conventional plate tank with a second resonant line. In this case, it is usually convenient to connect the plates directly to the free end of the line, then cou-

pling the antenna to the bridge end of the line. The antenna may be coupled in the manner shown in Fig. 1409 at "B" and "C" or it may be coupled inductively with a "hairpin" antenna coil such as that illustrated in Fig. 1412.

This type of circuit will usually operate satisfactorily on the 56-mc. band without any attention being given to the filament circuit. However, on the higher frequency bands it will usually be found necessary to include chokes in the filament lead in the manner indicated at "C" of Fig. 1409. A still better scheme, to be detailed later, is to use a tuned line in the filament circuit so adjusted that the electrical length of the path from the center of the filament to the grounded end of the line is a half wave.

The transmitters illustrated all employ medium-sized tubes. It should be understood that these identical circuits are equally suited for use with the smaller tubes — the only necessary modifications being in the mounting of

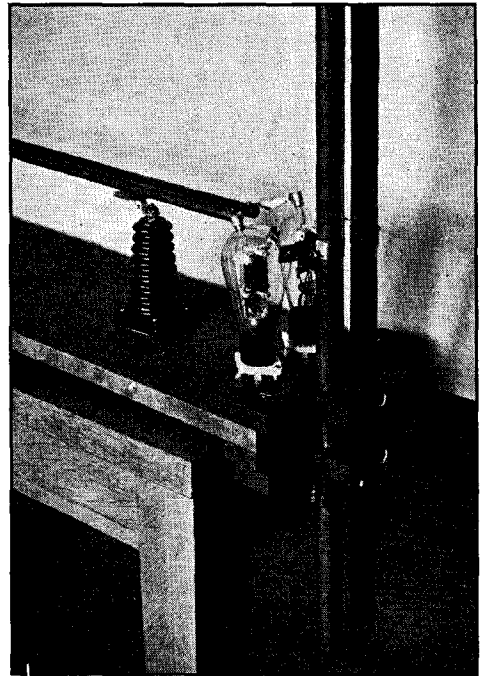

FIG. 1413 — AN ALTERNATIVE MECHANICAL ARRANGEMENT FOR THE GRID LINE OF A SHORT-LINE-CONTROLLED TRANSMITTER

*In this example the line is mounted with wooden clamps to the edge of the baseboard, the shorted end of the pipes dropping over the edge of the table. The heavy copper jumper or shorting bar may be seen immediately under the lower clamp. This set-up allows very short grid leads.*

the tubes themselves and in the circuit adjustment. With tubes such as the Type 45 it will be found that the grid taps can be placed very close to the bridge end of the line. This particular adjustment will vary greatly with the type of tube used.

It will be noted that in all these circuits the

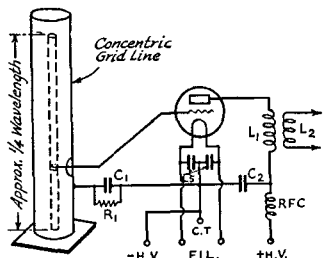

FIG. 1414—A TYPICAL SINGLE-TUBE TRANSMITTER WITH A CONCENTRIC GRID LINE

- $C_1$  — 100  $\mu$ fd. receiving type condenser.
- $C_2$  — 500  $\mu$ fd. high-voltage condenser.
- $C_3$  — Filament by-pass condensers — 500  $\mu$ fd. low voltage.
- $R_1$  — 10,000 to 50,000 ohms depending on tube used.
- $L_1$  — Size will depend greatly on type of tube and length of leads. Six turns of  $\frac{1}{8}$ -inch copper tubing  $1\frac{1}{2}$ -inch diameter suggested for first trial on 56 mc.
- $L_2$  — Two or three similar turns.

The inner conductor will be slightly less than 4 feet long for 56-mc. band operation; a few inches less than 2 feet for 112 mc.

grids are tapped on the grid line down toward the closed end of the line. This procedure has a definite influence on the performance of the line as a stabilizing device and care must be taken to make the grid connections as near to the closed end of the line as is consistent with reasonable efficiency in the oscillator.

The chief limitation of these circuits is in the open type of line used. In practice it is difficult to obtain a very high Q even when pipes two or three inches in diameter are used. Hence when excellent frequency stability is hoped for it is better to use the closed or concentric type of line. The construction of lines of this type has already been discussed.

### Practical Concentric-Line-Controlled Transmitters

● Fig. 1414 shows a simple circuit in which a concentric line is used in the grid circuit. The drawing itself shows the various components well separated, but in the actual transmitter the tube would be located immediately alongside the line to allow short leads from the grid to the inner conductor and from the filament circuit through  $C_1$  to the outer conductor. It is very important, also, that the plate tank be so mounted that the return path through  $C_2$  is

short. In this particular circuit the plate tank is self-resonant — the turn spacing in the relatively large coil used being varied until minimum plate current is had at the desired frequency (with the oscillator unloaded). While a cylindrical line is indicated on this diagram, it is obviously possible to replace it with the trough type of line.

Fig. 1415 shows an alternative circuit of the same general type. In this case, the filament and plate circuits are by-passed directly to the outer conductor, the gridleak being connected between the negative high voltage lead and ground. It is the circuit used in the 224-mc. transmitter illustrated in Fig. 1416. In this "trough line" transmitter the filament circuit is by-passed to the wall of the line by two 1-inch by  $1\frac{1}{2}$ -inch copper strips which serve also as the supports for the tubes. These strips are insulated from the wall of the line with thin mica as in the previous transmitter. The plate by-pass condenser is treated in similar fashion and consists of a 1- by 2-inch copper strip mounted on the upper surface of the line. The plate circuit consists of a "hairpin" of No. 14 bare wire about 3 inches long and 1 inch wide. It is supported from the plate terminal of the tube by an appropriately drilled and tapped section of  $\frac{1}{4}$ -inch square brass rod.

The line itself is made of fairly heavy copper sheet folded to form a trough  $2\frac{1}{2}$  inches wide and  $2\frac{3}{4}$  inches high. The end plate is soldered

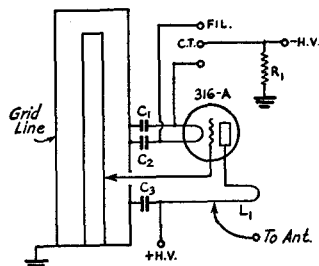

FIG. 1415 — THE CIRCUIT OF THE TROUGH-LINE CONTROLLED TRANSMITTER

- $L_1$  — Hairpin-shaped loop of No. 14 bare wire  $3\frac{1}{4}$  inches long and 1 inch wide.
- $C_{1,2}$  — Filament by-pass condensers made of copper strip, see text.
- $C_3$  — Plate by-pass condenser made in similar fashion.
- $R_1$  — 30,000-ohm 10-watt resistor.

The outer conductor of the grid line is one quarter-wave long (about 12 inches at  $1\frac{1}{4}$  meters). The inner conductor is 8 inches long and fitted with a sliding extension piece made of copper sheet rolled into tube form.

The antenna used with this experimental transmitter is a half-wave affair with a single wire transmission line connected to the antenna terminal shown on the diagram. This antenna is set up and adjusted in accordance with the principles explained in Chapter Sixteen.

# . . . . . Ultra-High-Frequency Transmitters

into position and the inner conductor, of  $\frac{3}{4}$ -inch outside diameter copper pipe, is soldered to it. The trough, for  $1\frac{1}{4}$ -meter operation, should be approximately 10 inches long. The inner conductor is only 8 inches long but is fitted with an extension piece of rolled copper sheet at the free end. This extension piece, about  $3\frac{1}{2}$  inches long, permits adjustment of the resonant frequency of the grid circuit. The grid is tapped about  $\frac{1}{4}$  the length of the inner conductor from its closed end.

Adjustment of this transmitter is also the acme of simplicity. The tube will oscillate with a wide range of plate circuit adjustments and it is merely necessary to vary the length of wire in the plate circuit until the plate current, with the oscillator unloaded, is a minimum at the desired operating frequency. The frequency is adjusted, of course, by variation of the position of the extension piece on the inner conductor of the line.

This type of circuit is equally suitable for use in transmitters using other types of tubes and operating on lower frequencies. The special by-pass condensers used in the 224-mc. transmitter could be replaced with conventional fixed condensers when the circuit is used on the lower frequencies. Also, the "hair-pin" tank circuit could be replaced with a conventional coil and condenser for 56-mc. operation. The only important requirement is that the tube and the plate tank should be mounted close to

the resonant line so that by-passing may be accomplished without any long leads.

## Push-Pull With Concentric Lines

● The circuits just discussed are ideal for a single-tube transmitter but in push-pull cir-

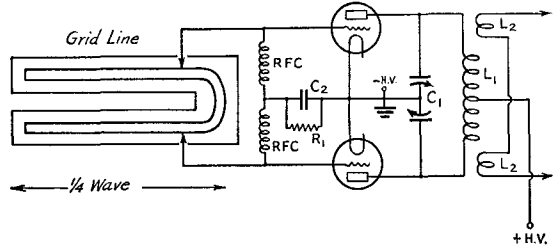

FIG. 1417 — CONCENTRIC-LINE GRID CONTROL APPLIED TO THE PUSH-PULL TRANSMITTER

Showing the use of a folded-half-wave concentric line.

For 56-mc. operation the total length of the inner conductor should be of the order of 80 inches, six-inch sliding extension pieces being fitted to the free ends to allow adjustment.  $\frac{3}{4}$ -inch copper pipe is suggested for the inner conductor, the square-section outer conductor being  $2\frac{1}{2}$  inches on a side. The remaining components will be similar to those already specified for other transmitters.

cuts, where we have two grids to be fed, they are impractical. It is necessary either to use a separate quarter-wave line for each tube or a half-wave line with the grids tapped on either side of the center of the line. The latter method is the preferred one.

Fig. 1417 is a representative circuit of a push-pull transmitter using a half-wave concentric line in the grid circuit. In this example, the line is folded back on itself to conserve space. The line may well be of the open "trough" design, the outer conductor being made of sheet copper formed into a square-section "U" shaped trough and the inner conductor of copper tubing bent to the shape indicated on the diagram. The resonant frequency of the line may be changed by sliding extension pieces on the free ends of the inner conductor. Support for the inner conductor could be a couple of blocks of dry wood fitted near the folded end of the line. Since this point is at a voltage node, the type of insulation used is not of particular importance.

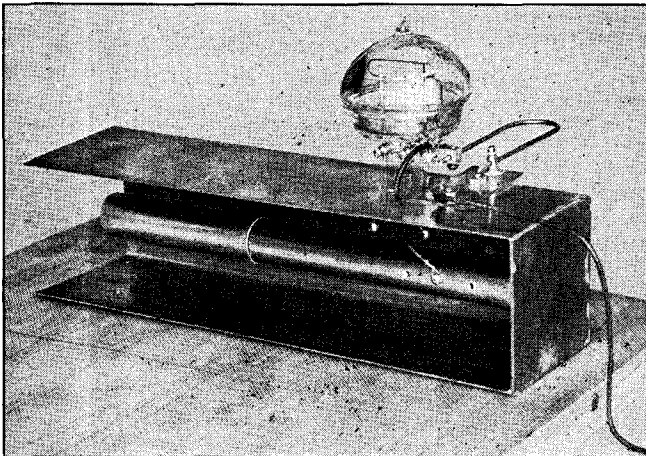

FIG. 1416 — A CONCENTRIC-LINE-CONTROLLED TRANSMITTER USING THE TROUGH-TYPE LINE AND THE W.E. 316-A TUBE

The resonant line serves as the chassis for the transmitter with the tube mounted to it by means of the filament by-pass condensers. This same method of assembly might well be used on the lower frequencies in transmitters using other types of tubes. This transmitter was described in QST for September, 1936.

# The Radio Amateur's Handbook . . . . .

The circuit is similar in other respects to those already described except that the grid returns are through r.f. chokes.

## The Importance of Filament Circuits

● On the ultra-high frequencies it is not always possible to consider the filament as a single point in the circuit, to be grounded or left free as circuit considerations require. In

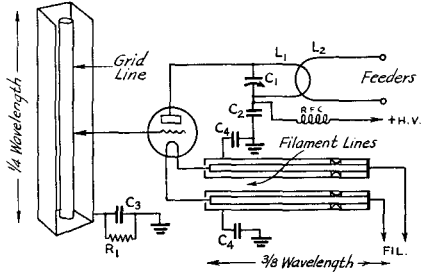

FIG. 1418—ILLUSTRATING THE USE OF CONCENTRIC LINES IN THE FILAMENT CIRCUIT OF A TRANSMITTER FOR THE ULTRA-ULTRA-HIGH FREQUENCIES

The two filament lines, shown in detail in Fig. 1419, should preferably be mounted flat on a baseboard covered with sheet copper or copper gauze. Thin mica between the lines and the base serves to insulate the filament circuit and to provide capacity to ground. With this arrangement the condensers  $C_4$  are unnecessary. The grid line might also be given similar treatment, so avoiding the need for  $C_3$ . While the circuit gives the impression that components are widely spaced, the transmitter, in practice, should be made as compact as possible. Values for the various components will be similar to those already described and will depend, of course, on the operating frequency desired.

many tubes, the leads to the filament and the filament itself total in length an appreciable fraction of a wavelength at, say, 112 mc. Grounding the filament terminals at the socket, in such cases, does not insure that the filament itself is at ground potential as far as r.f. is concerned. On the 56-mc. band, with the tubes ordinarily used in amateur work, this effect is rarely of any practical importance. On the higher frequencies, though, it is often the difference between success and failure.

In general it may be said that special consideration of the filament circuit, other than direct by-passing, is not necessary with the acorn types or with the 316-A at frequencies lower than 300 mc. Usually the conventional small triodes (such as the Types 45, 801 or 210) will operate successfully as high as 112 mc. without special treatment of the filament circuit. The larger tubes of the 800, 304-B, or T50 types almost invariably prove unsatisfactory on 112 mc. or higher with normal filament connections.

The simplest method of correcting for excessive electrical length of the filament and filament leads within the tubes is to add an r.f. choke in each filament lead. The size of the chokes is then adjusted until the r.f. potential at their grounded ends is the same as the filament itself. A second and more effective method is to insert a resonant line in the filament circuit — a line of such a length that the total filament circuit to ground is a half wave. Adjustment of such a line is much simpler than the adjustment of chokes. The choke method of treating the filament circuit is illustrated in Fig. 1409 at "C". The use of resonant line circuits is shown in Fig. 1418. In this example a concentric line is employed in the grid circuit. The filament arrangement could be followed, however, in any transmitter using a single tube. The construction of the trough-type filament lines is shown in Fig. 1419. Their actual length will depend, of course, primarily on the type of tube used. It is as well to make them at least  $\frac{3}{8}$  wavelength when they are to be used with special u.h.f. tubes of the 316-A type. The longer filament leads in conventional tubes will allow the use of a shorter line but the sliding jumpers provide ample adjustment facilities. In push-pull circuits operating at the very high u.h. frequencies it is convenient to make the filament circuit in the form of an open resonant line, the two pipes feeding one filament terminal of each tube and a wire running inside each pipe feeding the other filament terminals.

## Oscillator-Amplifier Transmitters

● All of the transmitters so far described are of the self-excited-oscillator type and as commonly used are modulated directly. This procedure, while avoiding complication, invariably results in frequency modulation of the signal. In the transmitters not using short-line frequency control this frequency modulation is extremely severe. Even in transmitters provided with a well-adjusted resonant grid line

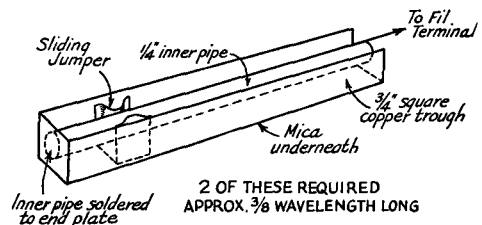

FIG. 1419—SHOWING THE CONSTRUCTION OF THE TROUGH-TYPE LINES SUGGESTED FOR USE IN THE FILAMENT CIRCUITS OF TRANSMITTERS DESIGNED FOR THE VERY HIGH FREQUENCIES

# Ultra-High-Frequency Transmitters

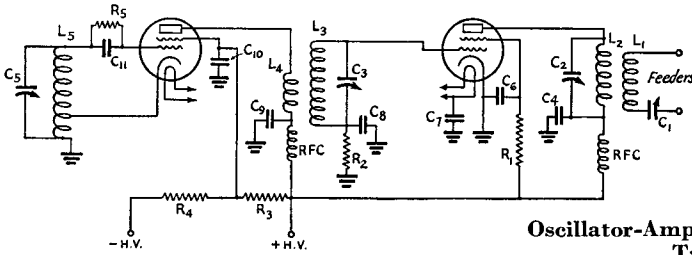

FIG. 1420 — A TYPICAL 56-MC. OSCILLATOR-AMPLIFIER CIRCUIT USING AN ELECTRON-COUPLED OSCILLATOR-DOUBLER AS THE DRIVING UNIT

- $C_1$  — 50- $\mu$ fd.  $C_8$  — 25- $\mu$ fd.  
 $C_2$  — 30- $\mu$ fd.  $C_4$  — 140- $\mu$ fd.  
 $C_5$  to  $C_{10}$  incl. — 250- $\mu$ fd. midget mica condensers.  
 $C_{11}$  — 100- $\mu$ fd. mica condenser.  
 $R_1$  — 50,000-ohm 1-watt resistor.  
 $R_2$  — 25,000-ohm 1-watt resistor.  
 $R_3$  — 50,000-ohm 20-watt resistor.  
 $R_4$  — 50,000-ohm 2-watt resistor.  
 $R_5$  — 25,000-ohm 1-watt resistor.  
 RFC — National Type 100 chokes.  
 $L_1$  — 2 turns No. 12 enamelled wire, coil diameter  $\frac{7}{8}$  inch.  
 $L_2$  — 4 turns No. 12 enamelled wire, coil diameter  $\frac{7}{8}$  inch, length  $\frac{5}{8}$  inch.  
 $L_3$  —  $3\frac{1}{2}$  turns No. 12 enamelled wire, coil diameter  $\frac{7}{8}$  inch, length  $\frac{1}{2}$  inch.  
 $L_4$  — 3 turns No. 12 enamelled wire, coil diameter  $\frac{7}{8}$  inch, length  $\frac{3}{8}$  inch.  
 $L_5$  —  $5\frac{1}{2}$  turns No. 12 enamelled wire, on 1-inch diameter (National) coil form, length  $\frac{7}{8}$  inch; tapped  $1\frac{1}{2}$  turns from ground end.

Type 58 tubes are suggested for low power work. The suppressor is connected to the screen in the oscillator and to the cathode in the amplifier. Type 802 or RK 23 or 25 tubes would serve to give higher power. Slight changes in the coil values and in the screen supply resistors may be necessary in this case.

the frequency "wobulation" can be enough to prevent effective reception of the signal with a modern superhetro-type receiver. A really stable signal can be had only by first providing a stable oscillator, using it to drive one or more amplifiers and then modulating the final stage. A very great improvement in the stability of the transmitted signal is made possible by using any of the transmitters described as the oscillator of an oscillator-amplifier transmitter, then modulating the amplifier. It is ex-

tremely difficult to obtain amplification on frequencies of 112 mc. and above for these frequencies, practical considerations restrict us to the use of resonant lines in the modulated oscillator.

## Oscillator-Amplifiers With Conventional Tank Circuits

● In many instances, particularly when the transmitter must be built in a restricted place, it is impractical to use resonant lines in the transmitter. Fortunately, it is still possible to obtain a satisfactory performance with the more conventional type of tank circuit.

Fig. 1420 illustrates a low-powered oscillator-amplifier of this type in which screen-grid tubes are used to avoid the necessity of neutralization. Several types of screen-grid tubes are available for this type of work and the circuit arrangement has many useful applications.

The idea behind this general type of circuit is that the oscillator is of the electron-coupled type, the oscillator portion operating on half the frequency to which the plate load circuit is tuned. The second tube is a conventional amplifier. A splendid improvement in the order of the frequency modulation is made possible with this arrangement.

Any of the screen-grid tubes are suited for use in this circuit, the 58 serving well for a very low powered rig, the 802 or RK 25 filling the

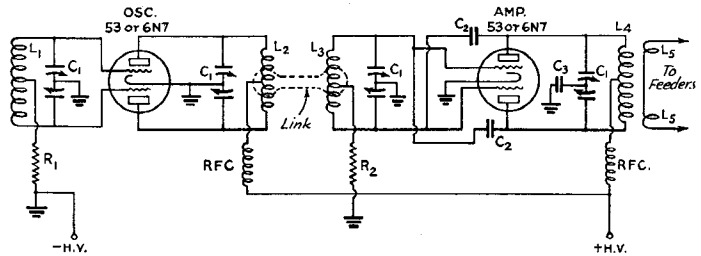

FIG. 1421 — THE CIRCUIT OF A TYPICAL TRANSMITTER USING TWIN TRIODES AS PUSH-PULL OSCILLATOR AND AMPLIFIER

- $C_1$  — Split stator condensers with 50  $\mu$ fd. per section.  
 $C_2$  — Modified receiver type condensers with one stator and one rotor plate double spaced. Special small 5- $\mu$ fd. neutralizing condensers are, of course, preferable.  
 $C_3$  — .01 fixed condenser.  
 $R_1$  — 2000-ohm 1-watt resistor.  $R_2$  — 1500-ohm 1-watt resistor.  
 For 56-mc. the coils, of No. 12 wire should be:  
 $L_1$  — 3 turns 1" diameter.  $L_3$  —  $2\frac{1}{2}$  turns  $1\frac{1}{8}$ " diameter.  
 $L_2$  —  $1\frac{1}{2}$  turns  $1\frac{1}{8}$ " diameter.  $L_4$  — 4 turns  $1\frac{1}{8}$ " diameter.  
 $L_2$  and  $L_3$  may be coupled with a single turn link as indicated or they may be so located on the chassis as to allow adjustable inductive coupling between the coils themselves.

RFC — National Type 100 chokes. A plate voltage of 250 is suggested for the oscillator. It should be obtained from a separate power supply if possible. The amplifier plate voltage should be of the order of 300.

# The Radio Amateur's Handbook . . . . .

bill for higher power. When the 58 is used as an oscillator, the screen and suppressor grid should be connected together. In the amplifier stage the suppressor of the 58 should be connected to cathode in the usual manner.

Circuits of this type are similar to those used in transmitters for the lower frequencies. Problems of lay-out and wiring will be simplified by study of Chapters Eight and Nine.

## Using Twin-Triode Tubes in the Oscillator-Amplifier

● An effective type of circuit for mobile or general low-power work is illustrated in Fig.

1421. The tube at the left-hand side of the circuit is the oscillator arranged in a tuned-grid tuned-plate circuit. Its plate tank is link-coupled to the tuned grid circuit of the amplifier stage in which a similar tube is used. The amplifier tubes are neutralized in the conventional manner.

Almost any of the popular transmitting tubes may be arranged in circuits of this type for 56-mc. operation, and providing the basic principles of transmitter adjustment treated in Chapter Eight are observed, effective performance should be had just so long as the oscillator has a power output closely comparable with

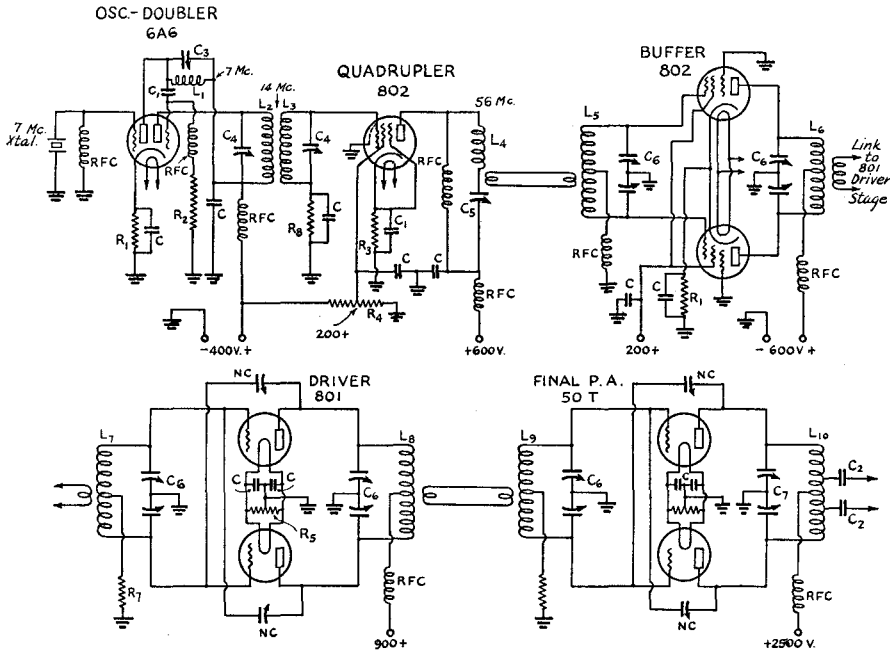

FIG. 1422 — THE CIRCUIT OF A PRACTICAL CRYSTAL-CONTROLLED TRANSMITTER FOR 56 MC.

- L<sub>1</sub> — 15 turns No. 20, 1½" diameter, no spacing.
- L<sub>2</sub> — 9 turns No. 20, 1½" diameter, spaced thickness of wire.
- L<sub>3</sub> — 7 turns No. 20, 1½" diameter, spaced thickness of wire.
- L<sub>4</sub> — 7 turns No. 12 e., 1¼" diameter, spaced thickness of wire.
- L<sub>5</sub> — 5 turns No. 12 e., 1¼" diameter, spaced thickness of wire.
- L<sub>6</sub> — 5 turns No. 12 e., 1¼" diameter, spaced twice thickness of wire.
- L<sub>7</sub> — 4 turns No. 12 e., 1¼" diameter, spaced twice thickness of wire.
- L<sub>8</sub> — 4 turns No. 12 e., 1¼" diameter, spaced twice thickness of wire.
- L<sub>9</sub> — 4 turns No. 12 e., 1¼" diameter, spaced twice thickness of wire.
- L<sub>10</sub> — 5 turns No. 12 e., 1¾" diameter, spaced twice thickness of wire.
- C — 0.01-μfd. 1000-volt mica by-pass condensers.
- C<sub>1</sub> — 50-μfd. 1000-volt mica grid-coupling condenser.

- C<sub>2</sub> — 0.002-μfd. 5000-volt mica.
- C<sub>3</sub> — 100-μfd. variable receiving-type condenser.
- C<sub>4</sub> — 50-μfd. variable receiving-type condenser.
- C<sub>5</sub> — 25-μfd. variable receiving-type condenser.
- C<sub>6</sub> — Split-stator isolantite variable condenser (double-spaced) 36-μfd. per section.
- C<sub>7</sub> — Split-stator isolantite variable condenser, spacing 0.19", 15-μfd. per section.
- NC — Neutralizing condensers.
- R<sub>1</sub> — 400-ohm 3-watt.
- R<sub>2</sub> — 25,000-ohm 1-watt.
- R<sub>3</sub> — 2000-ohm non-inductive.
- R<sub>4</sub> — 50,000-ohm adjustable 10-watt.
- R<sub>5</sub> — 50-ohm center-tapped.
- R<sub>6</sub> — 6000-ohm 50-watt.
- R<sub>7</sub> — 10,000-ohm 25-watt.
- R<sub>8</sub> — 250,000-ohm 1-watt.
- RFC — Standard pie-wound ultra-high frequency chokes.
- RFC<sub>1</sub> — High-frequency transmitting choke.

# . . . . . Ultra-High-Frequency Transmitters

that expected from the amplifier. On frequencies higher than 60 mc., it becomes increasingly difficult to obtain excitation for the amplifier and it is suggested that only very experienced workers should attempt the oscillator-amplifier type of transmitter if operation is to be expected on the 112-mc. band. For the still higher frequencies, the simple short-line controlled oscillators are recommended.

## Crystal-Controlled Transmitters

● Improvements in tube and circuit design and the constant demand for absolute freedom from frequency modulation on the ultra-high frequencies have led to the development of thoroughly practical crystal-controlled transmitters for the 56-60-mc. band. These transmitters are more complex than the types already described but their performance is, of course, incomparably better.

Since the crystal-controlled transmitters follow so closely the general principles discussed for lower frequency working in Chapters Eight and Nine, no attempt will be made to describe them in full detail at this point. Their planning, construction and adjustment comprise an extension of the technique developed for the lower frequencies. Amateurs unfamiliar with that technique would be ill-advised to dive headlong into the complex field of crystal control on the ultra-high frequencies.

Fig. 1422 is a selected example of good practice in the design of a crystal-controlled trans-

mitter for the 56-mc. band. The complete arrangement comprises a high-powered transmitter but elimination of the final stage is possible if lower power is desired.

The crystal oscillator in this transmitter uses one section of a twin triode operating on 7 mc. The second section serves as a doubler to 14 mc. with its output inductively coupled to the 802 quadrupler. The output of this tube, now on 56 mc. is link-coupled to the push-pull buffer which in turn is link-coupled to what would be the final amplifier in the low-powered version of the transmitter. This pair of neutralized 801's, in the complete transmitter, drives a similarly arranged pair of 50T's. The diagram and circuit constants will give the experienced amateur a general picture of the installation. A full description of the transmitter appeared in August, 1936, *QST*.

An alternative approach to the crystal-control problem is to use the twin triodes in the frequency multiplying section all the way to 56 mc., then using larger tubes as straight amplifiers. The circuit of the exciter unit of such a transmitter is given in Fig. 1423.

The exciter unit is quite similar to those shown in Chapter Nine but with a few modifications to adapt it for this particular work. The crystal is on 3.5 mc. using half of the first 53 as the oscillator. Frequency doubling is accomplished in the plate circuit of this section by using the usual double plate tank, one tuned to 3.5 mc. and the other to 7 mc. The other

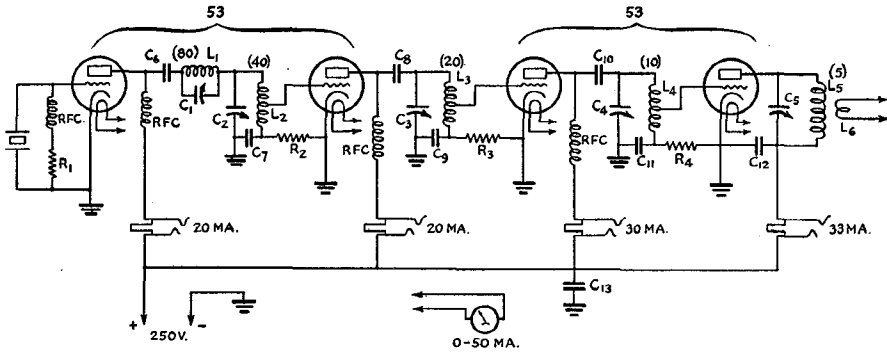

FIG. 1423 — THE CIRCUIT OF THE EXCITER UNIT USING TWIN TRIODES

- R<sub>1</sub> — 10,000 ohms, 1 watt.
- R<sub>2</sub> — 20,000 ohms, 1 watt.
- R<sub>3, 4</sub> — 10,000 ohms, 1 watt.
- C<sub>1</sub> — 140 μfd. leaf type trimmer condenser.
- C<sub>2, 3, 4</sub> — 35 μfd. receiving type midget condensers.
- C<sub>5</sub> — 15 μfd. ditto.
- C<sub>6</sub> — 100 μfd. leaf type trimmer condenser.
- C<sub>7</sub> — 0.001 μfd. fixed.
- C<sub>8</sub> — 100 μfd.

- C<sub>9</sub> — 0.001 μfd.
- C<sub>10, 11, 12</sub> — 100 μfd.
- C<sub>11, 12</sub> — 0.001 μfd.
- R. F. C. National R100 chokes.
- L<sub>1</sub> — 10 feet of No. 26 d.s.c. wire scramble wound on a 1/2-inch diameter dowel.
- L<sub>2</sub> — 20 turns of No. 14 wire occupying 1 1/2 inches. Tap is 6 turns from grounded end.
- L<sub>3</sub> — 10 turns of No. 14 wire spaced to fill 1 inch. Tap at four

- turns from grounded end.
- L<sub>4</sub> — 6 turns of No. 14 spaced to fill 1 inch. Tap at center of coil. This coil is self supporting.
- L<sub>5</sub> — 4 turns of No. 14 spaced to fill 1 inch. This coil also self supporting.
- L<sub>2</sub> and L<sub>3</sub> are wound on Hammarlund receiving coil forms.
- L<sub>6</sub> — 2 turns No. 14, 1 1/4 inch diameter.

triode section of this tube doubles to 14 mc. One section of the next 53 doubles to 28 mc. and the other section doubles to 56 mc., delivering about 1 watt.

In the construction of this unit the chief precaution is to keep all leads to grids and plates and their returns to cathode as short as possible. It is also very necessary to make careful adjustment of the coils throughout the unit in order to get the largest possible coil while still retaining just enough tuning capacity for adjustment purposes. In equipment of this type it is essential to have extremely low-C circuits.

The output of an exciter of this type may be link-coupled to a higher powered stage such as the push-pull buffer of Fig. 1422. In the original transmitter with which this exciter was used, the output of the last 53 triode section was coupled to a pair of 802's with an open resonant line in their plate circuit. The output of this stage then excited a pair of 800 tubes which were also fitted with an open-type plate line. The complete transmitter was detailed in August, 1936, *QST*.

It will be seen from the crystal-controlled circuits already presented that the general scheme is very similar to that used in lower-frequency transmitters. Indeed, it is often convenient and desirable to use an existing

medium frequency transmitter or exciter as the source of excitation for the 56-mc. output stage. A 56-mc. unit suitable for addition to the existing exciter or transmitter may require a doubler in addition to the final amplifier, but the saving in equipment may be worth while even so.

## A Compact Two-Tube Crystal-Controlled Transmitter

● Fig. 1424 illustrates a particularly compact crystal transmitter which was designed especially for mobile use but which might well serve also for fixed-station operation. The modulated-oscillator transmitter has the advantage of simplicity for mobile work but its poor frequency stability is usually a great disadvantage. Resonant lines, because of their size can rarely be used as a stabilizing device and hence it is necessary to go to some form of oscillator-amplifier in order to get stability. The transmitter illustrated was built to illustrate one method of getting crystal-control in such a transmitter while still maintaining the economy of operation had with the more conventional self-excited-oscillator-amplifier transmitter.

The transmitter is unconventional in two respects. First, the crystal tube is bigger than that used in the output stage. Then, the output

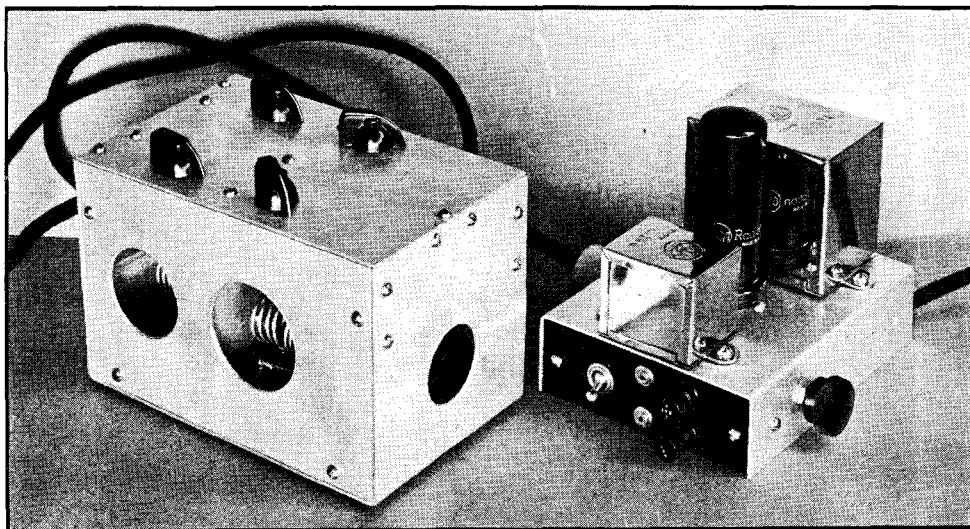

FIG. 1424 — A MINIATURE CRYSTAL-CONTROLLED TRANSMITTER DESIGNED FOR MOBILE OPERATION

*Using three metal tubes in a compact assembly, this transmitter is capable of at least 5 watts output. The two tubes of the transmitter proper are arranged in a box separate from the modulator so that the latter may be mounted in a position convenient for manipulation even when the transmitter itself is mounted elsewhere in the proximity of the antenna. The holes in the box are for ventilation.*



# . . . . . Ultra-High-Frequency Transmitters

tube is operated as a doubler. This arrangement is made possible because unusually high output is had from the crystal tube, because some regeneration is provided in the final stage and because the latter is arranged in a push-push type circuit. The result is a transmitter of extreme simplicity. The normal power output from the transmitter is 5 watts when operated from a 300-volt supply and full Class-C operation of the output tube allows 100 per cent modulation.

The transmitter illustrated is built on an aluminum chassis (consisting of a panel and middle shelf) arranged to fit in an aluminum box measuring 7 by 4½ by 4½ inches. This calls for an extremely compact assembly but the care taken in layout is well repaid by the very short leads throughout the r.f. portions of the set. One novel feature of the assembly is that the side of

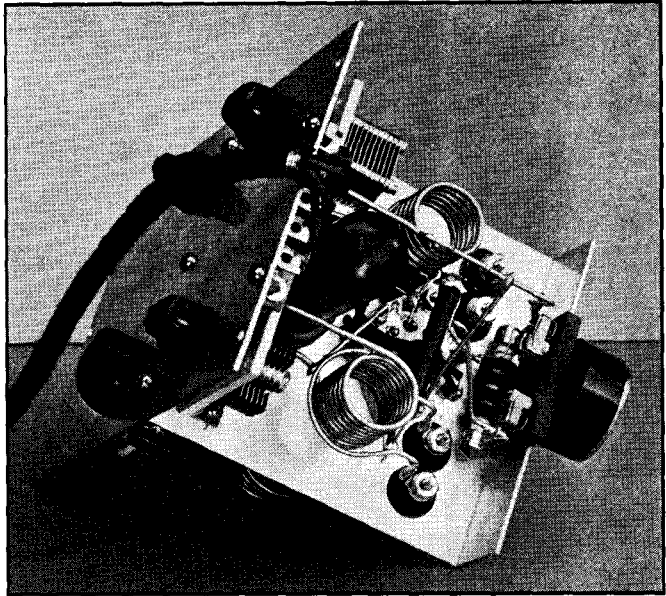

FIG. 1426 — THE UNDER SIDE OF THE MOBILE TRANSMITTER SHOWING THE COMPONENTS OF THE CRYSTAL OSCILLATOR SECTION

The tube showing in this view is the output tube, the socket and associated parts of which are on the other side of the shelf. Visible in this view are the crystal, right, mounted where it will be "in the cool" outside the box; the crystal tube grid circuit coil and condenser, top; and the crystal tube plate circuit, front, with the link mounted on the two bushings. All parts are mounted close to the oscillator tube socket.

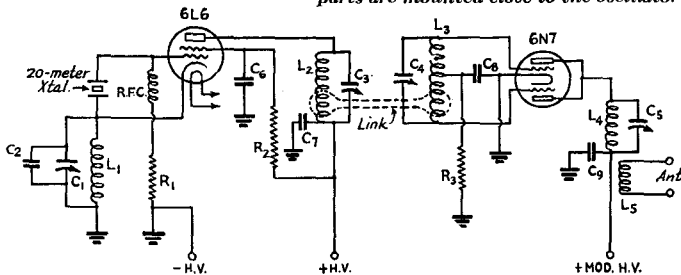

FIG. 1425 — THE CIRCUIT OF THE MOBILE TRANSMITTER

- C<sub>1</sub> — 75  $\mu$ fd. National Ultra-Midget condenser.
  - C<sub>2</sub> — 100  $\mu$ fd. fixed midget condenser.
  - C<sub>3</sub>, C<sub>4</sub> — 35  $\mu$ fd. Ultra-Midgets.
  - C<sub>5</sub> — 75  $\mu$ fd. Ultra-Midget with half plates removed and remainder double spaced.
  - C<sub>6</sub>, C<sub>7</sub> — 500  $\mu$ fd. midget fixed condensers.
  - C<sub>8</sub> — 75  $\mu$ fd. midget fixed condenser.
  - C<sub>9</sub> — 250  $\mu$ fd. midget.
  - R<sub>1</sub> — 50,000-ohm 1-watt resistor.
  - R<sub>2</sub> — 30,000-ohm 1-watt resistor.
  - R<sub>3</sub> — 5000-ohm 1-watt resistor.
  - L<sub>1</sub> — 6 turns of No. 14 spaced to occupy ¾ inch.
  - L<sub>2</sub> — 9 similar turns spaced to occupy 1⅙ inches.
  - L<sub>3</sub> — 10 similar turns spaced to occupy 1⅙ inches.
  - L<sub>4</sub> — 4 similar turns spaced to occupy ⅝ inch.
  - L<sub>5</sub> — 3 similar turns.
- All coils have an inside diameter of ¾ inch.  
R.F.C. — National Type 100 choke.

the shelf on which the crystal tube socket is mounted also accommodates the components in the crystal circuit while the doubler circuit components are arranged around the oscillator tube (on the other side of the shelf). This arrangement results from mounting the two tubes end to end and offset slightly.

The crystal circuit is the conventional Tri-Tet using the 6L6 tube and a 14-mc. crystal. The plate circuit, tuned to 28 mc. is link coupled to the grid circuit of the final tube which, it will be seen, has the grids of the two triode sections connected in push-pull and the plates in parallel. The by-pass condenser C<sub>8</sub> is of particular importance in that its presence introduces regeneration in the doubler. By increasing this capacity to 100 or 150  $\mu$ fd. the output tube can be made to oscillate. In the original transmitter a 75  $\mu$ fd. condenser provided enough regeneration without causing any tendency toward self oscillation.

# The Radio Amateur's Handbook . . . . .

The construction of a set of this type involves very careful consideration of every single wire and the preliminary adjustment of its circuits and coils is a problem which can be handled satisfactorily only by the amateur

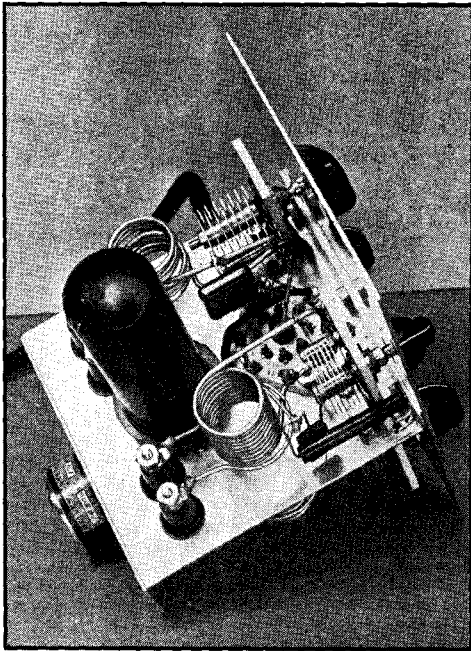

FIG. 1427 — THE UPPER LAYER OF THE MOBILE CRYSTAL-CONTROLLED TRANSMITTER

The tube in this view is the crystal oscillator. Beside it is the socket of the output tube. In the foreground can be seen the grid circuit of the output tube complete with link, by-pass condenser, and grid resistor. On the far side is the plate coil and condenser of the output tube with its by-pass condenser. The antenna coil is mounted on two porcelain insulators almost hidden by the tube.

familiar with crystal-control practice. In operation the crystal tube plate and screen current should total approximately 35 ma. at 300 volts. The doubler plate current will be of the same order under load. These values allow an extra 30 ma. for the modulator when the set is run from a Genemotor type of supply.

Since the modulator unit of this transmitter is an integral part of the installation its circuit is given. It is a perfectly conventional Class-A modulator using a 6L6 driven directly from a single-button microphone and transformer. The modulator can be driven to full capacity only when a high voice level is used but this condition applies in any mobile installation (particularly in an airplane). The output trans-

former is made necessary since the load impedance of the modulated stage is higher than that required for the modulator.

## The Modulator Problem

● The subject of modulator design for the u.h.f. transmitter is, of course, of very wide scope. However, since it differs in no way from the same problem as it applies to lower frequency transmitters we are not justified in offering any detailed extension of the material appearing in Chapters Eleven and Twelve. A study of those chapters will quickly reveal the fundamental principles involved in choosing modulator tubes and their companion speech amplifiers. In the smaller transmitters, particularly when they are used for portable and mobile work, the modulator is often simplified by using a pentode operated Class-A and driven from a single-button microphone in the manner indicated in Fig. 1428.

## The Transceiver

● In the earlier days of u.h.f. work, when most of the activity was with portable equipment, a reduction of weight and general simplification was made by using the same tubes for transmission as for reception. The so-called "transceivers" built around this idea are still very much worth-while for portable and mobile work but they are frowned upon as equipment for the fixed station in a populous center because of their ability to cause severe radiation when operating in the receiving position. Some of the later types of transceivers are provided with means for reducing the plate voltage in the receiving position and therefore do not offend as seriously. Generally speaking, it is less expensive to purchase a complete transceiver than to build one.

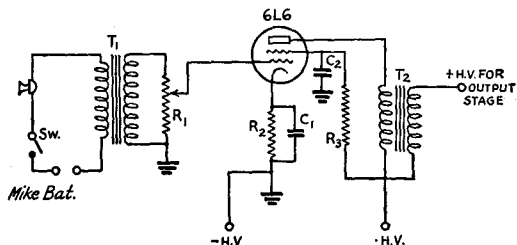

FIG. 1428 — THE SIMPLE MODULATOR USED WITH THE MINIATURE TRANSMITTER

- T<sub>1</sub> — UTC Type CS103 microphone transformer.
- T<sub>2</sub> — UTC Type CS34 used back-to-front to give a step-up turn ratio of 1 to 1.2.
- R<sub>1</sub> — 500,000-ohm potentiometer.
- R<sub>2</sub> — 350-ohm 5-watt resistor.
- R<sub>3</sub> — 25,000-ohm 1-watt fixed resistor.
- C<sub>1</sub> — 25  $\mu$ fd. 50-volt electrolytic condenser.
- C<sub>2</sub> — .5  $\mu$ fd. tubular-type condenser.

# 15

## ***Design and Construction of Power Supply Equipment***

### **RECTIFIERS—FILTERS—PRACTICAL PLATE AND FILAMENT SUPPLY FOR TRANSMITTERS AND RECEIVERS—VOLTAGE DIVIDERS—TRANSMITTER BIASING VOLTAGE SUPPLY—TRANSFORMER AND FILTER CHOKE CONSTRUCTION—PORTABLE AND INDEPENDENT SYSTEMS**

**F**ULLY as important as the transmitter itself is the apparatus which supplies the power to the tube filaments and plates. The operation of a well-designed transmitter can be spoiled by a poor power supply. Although the power supply involves only the use of simple apparatus in most cases, good design and adjustment will be well rewarded by improvement in the signal and in the over-all effectiveness of the transmitter.

In this chapter we shall consider various types of power supplies for both transmitters and receivers. It is the function of both to provide steady power for the tube filaments and direct current for the plates. Filament supply with modern transmitting and receiving tubes is relatively simple; the design of the plate supply, however, depends to a considerable extent upon the type of service to which it is to be put and is therefore worthy of careful consideration. We shall discuss first the plate supply for the transmitter.

#### **The Plate Supply**

● Under the regulations governing amateur stations the plate supply must deliver adequately-filtered direct current to the plates of all tubes in transmitters operating on

frequencies below 30,000 kc. This requirement is designed to ensure that the emitted signal will be "pure d.c." on the five most important amateur bands, and to prevent transmitters having poor frequency stability from producing broad signals.

High-voltage direct current for the transmitting tubes can be obtained in a number of ways. These include banks of dry or storage cells connected in series to give the required voltage, dynamotors and motor-generators, and transformer-rectifier-filter systems. The latter are by far the most generally used.

The output of dry-cell or storage batteries is ideal for the transmitter because it is steady, pure direct current. Except for very low-power transmitters, however, the battery cost is a great deal more than the cost of other

power supply apparatus of the same voltage output; furthermore, the current that can be taken from the batteries is extremely limited if reasonable battery life is to be secured. Not more than 30 milliamperes should be taken continuously from standard-size "B" batteries; at this discharge rate the life of the battery should be approximately 200 hours. The heavy-duty batteries can stand higher discharge rates and will last longer. Because

#### **DANGER—HIGH VOLTAGE!**

**It must be realized that the plate supply equipment of even a low-powered transmitter is a potential lethal machine. It is ever ready to deal out sudden death to the careless operator. A number of amateurs, indeed, have been killed by the output of their power supplies during the last few years. Many more have suffered severe injury. We cannot urge too strongly the observance of extreme care in the handling of power supplies and transmitters.**

# The Radio Amateur's Handbook . . . . .

of their cost and relatively short life, batteries are used chiefly for portable transmitters — particularly with ultra-high frequency equipment — and in locations where no other source of power is available, such as on farms.

A direct-current motor-generator set is an excellent source of plate power. It is relatively

though the *amplitude* of the current and voltage may vary continually. At (2) we have the secondary of a power transformer connected to a single rectifier element. The rectifier is assumed to be “perfect,” that is, current can only flow through it in one direction, from the plate to the cathode. Its resistance to flow of

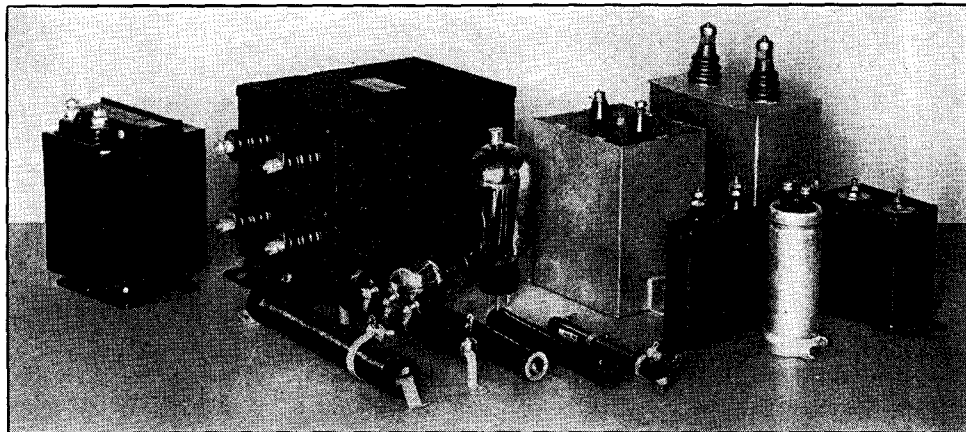

CHOKES, TRANSFORMERS, CONDENSERS, RECTIFIERS AND RESISTORS — THE ESSENTIALS OF ALL POWER SUPPLY SYSTEMS

costly, however, and its output is not as pure as that from batteries because of the ripple caused by commutation. The commutator ripple can be filtered out with little difficulty; a 1- or 2- $\mu$ f. condenser shunting the output usually will be sufficient.

A dynamotor is a double-armature machine; one winding drives it as a motor while the other delivers a few hundred volts d.c. for the transmitting tubes. The motor winding usually operates from a six- or twelve-volt storage battery. The dynamotor also has commutator ripple, which must be filtered out just as with the motor-generator set.

## The Rectifier-Filter Systems

● Assuming that alternating-current power is available at 110 or 220 volts, a very effective high-voltage supply system can be built up from a high-voltage transformer, a rectifier system and a filter. The details of the transformer and the filter are to be given complete treatment later in the chapter and for the moment we will limit the discussion to the rectifier.

An understanding of how a rectifier functions may be obtained by studying Fig. 1501. At (1) is a typical a.c. wave, in which the polarity of the current and voltage goes through a complete reversal once each cycle. The object of rectification is to transform this wave into one in which the polarity is always the same, al-

though the *amplitude* of the current and voltage may vary continually. At (2) we have the secondary of a power transformer connected to a single rectifier element. The rectifier is assumed to be “perfect,” that is, current can only flow through it in one direction, from the plate to the cathode. Its resistance to flow of current in that direction is zero, but for current of opposite polarity its resistance is infinite. Then during the period while the upper end of the transformer winding is positive, corresponding to A in (1), current can flow to the load unimpeded. When the current reverses, however, as at (1) B, it cannot pass through the rectifier, and consequently nothing flows to the load. The drawing shows how the output from the transformer and rectifier looks. Only one-half of each cycle is useful in furnishing power to the load, so this arrangement is known as a “half-wave” rectifier system.

In order to utilize the remaining half of the wave, two schemes have been devised. At (3) is shown the “full-wave center-tap” rectifier, so called because the transformer secondary winding must consist of two equal parts with a connection brought out from the center. In (3), when the upper end of the winding is positive, current can flow through rectifier No. 1 to the load; this current cannot pass through rectifier No. 2 because its resistance is infinite to current coming from that direction. The circuit is completed through the transformer center-tap. At the same time the lower end of the winding is negative and no current can flow through rectifier No. 2. When the current reverses, however, the upper end of the winding is negative and no current can flow through rectifier No. 1, while the lower end is positive and therefore rectifier No. 2 passes current to

the load, the return connection again being the center-tap. The resulting wave shape is again shown at the right. All of the wave has been utilized, and the amount of power which can be realized at the load is doubled. In order to maintain the same output voltage (instantaneous, not average) as at (2), however, each half of the transformer secondary must be wound for the same voltage as that furnished by the whole winding in (2); or, conversely, the total transformer voltage with the connections shown in (3) must be twice the desired output voltage.

If the transformer has no center-tap, or if the total voltage it furnishes is the same as the desired output voltage, scheme (4), known as the "bridge" rectifier, may be used to obtain full-wave rectification. Its operation is as follows: When the upper end of the winding is positive, current can flow through No. 2 to the load, but not through No. 1. On the return circuit, current flows through No. 3 back to the lower end of the transformer winding. When the wave reverses and the lower end of the winding becomes positive, current flows through No. 4 to the load and returns through No. 1 to the upper side of the transformer. The output wave shape is shown at the right. Although this system does not require a center-tapped transformer, and the voltage of the winding need only be the same as that desired for the load, four rectifier elements are required, so that the center-tap may actually prove to be more economical, all things considered.

Although the rectifier output is direct current in the sense that the polarity is always the same, the amplitude is not uniform but varies continually as shown in Fig. 1501. Before the power can be supplied to the transmitting-tube plates the "humps" must be smoothed out by a filter. Filters will be considered in detail in a later section.

### Types of Rectifiers

● Practically all rectifiers in use today by amateurs are of the vacuum-tube type; in former years when suitable tube rectifiers were not available many other types, including chemical, rotating (synchronous), and mercury-arc were in general use. These are now of relatively little importance in amateur transmitters, and since they have no particular advantages over the widely-used tube rectifiers will not be treated in this chapter.

There are two types of tube rectifiers: those having a high vacuum, in which the conduction is purely by means of the electronic stream from the cathode to the plate; and those in which a small quantity of mercury has been introduced after the tube has been evacuated.

In the latter type, part of the mercury vaporizes when the cathode reaches its operating temperature, and during the part of the cycle in which the rectifier is passing current the mercury vapor is broken down into positive

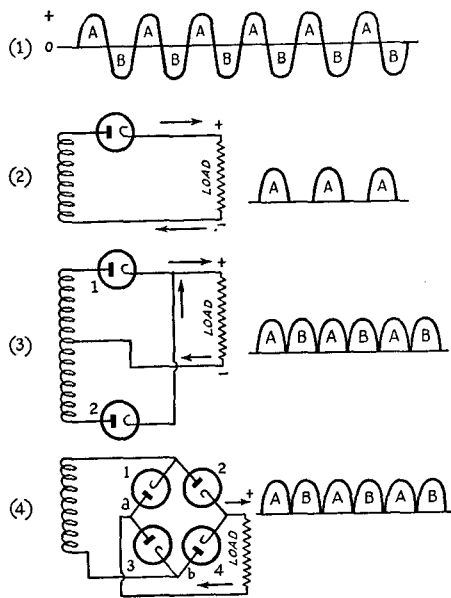

**FIG. 1501 — FUNDAMENTAL RECTIFIER CIRCUITS**

At (1) is the conventional representation of the a.c. wave; (2) shows a half-wave rectifier; at (3) is the full-wave center-tap system; and (4) is the "bridge" rectifier. The output wave form with each type of rectifier is shown at the right.

and negative ions; the positive ions decrease the normal resistance of the plate-cathode circuit so that the voltage drop in the tube is less than with high-vacuum types. As a result of the lower voltage drop the power lost in the rectifier is decreased, and the efficiency of the mercury-vapor rectifier is therefore greater than that of the high-vacuum type.

### Operating Limits of Rectifiers

● Two factors determine the safe operating limits of tube rectifiers. These are the maximum inverse peak voltage and the maximum peak current.

The inverse peak voltage is the maximum voltage which appears between the plate and cathode of the rectifier tube during the part of the cycle in which the tube is not conducting. Referring again to Fig. 1501, in (2) it is apparent that during the "B" part of the cycle when the half-wave rectifier does not conduct, the inverse potential between the plate and cathode will be equal to the full transformer voltage; the peak value of this voltage is 1.4 times the r.m.s. or effective output voltage. In

# The Radio Amateur's Handbook . . . . .

the full-wave centertap rectifier of (3), during the part of the cycle when rectifier No. 1 is non-conducting the inverse potential across its elements is equal to the sum of the potentials of both halves of the secondary of the transformer; the peak inverse voltage is again 1.4 times the full transformer voltage. Inspection will show that this is similarly the case with the bridge rectifier, circuit (4). It is well to remem-

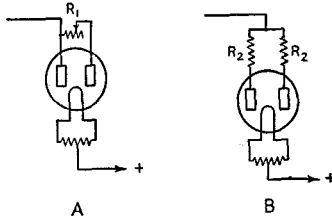

FIG. 1502 — METHODS OF BALANCING FULL-WAVE RECTIFIER PLATE CURRENTS WHEN PLATES ARE CONNECTED IN PARALLEL.  $R_1$  MAY BE AN ORDINARY 30-OHM FILAMENT RHEOSTAT.  $R_2$  SHOULD BE 50 TO 100 OHMS

ber that, no matter what the type of rectifier, the inverse peak voltage is always 1.4 times the total transformer voltage. Strictly speaking, the voltage drop in one rectifier tube should be subtracted from the figure so calculated, but since the rectifier drop usually is negligible in comparison with the transformer voltage, no practical error results from neglecting it. Because it is always the total transformer voltage which must be considered, we find that for a given inverse peak voltage rating the permissible output voltage with the bridge rectifier circuit is twice that with the center-tap circuit, because in the latter circuit only half the total transformer voltage is available for the load. The bridge circuit, however, requires twice as many rectifier elements.

The peak current through the rectifier tube is chiefly a function of the load and the type of filter circuit used. We shall have more to say on this point in the section on filters.

While inverse peak voltage and peak current ratings apply to both high-vacuum and mercury-vapor rectifiers, they have more significance with the mercury-vapor types than with the vacuum types. In the vacuum-type rectifiers the inverse voltage which the tube will handle safely is limited chiefly by the spacing between the plate and cathode and the insulation between the leads from these elements in the glass press and in the base. In the mercury-vapor rectifier, however, the inverse peak voltage is a function of the design of the tube and the operating temperature; for a given tube type there is a critical voltage above which an "arc-back" will occur, ruining the tube. The higher the temperature of the mer-

cury vapor the lower the voltage at which arc-back will take place; for this reason mercury-vapor rectifier tubes should always be located so that there is free circulation of air around them for cooling. The tubes are usually rated at a peak inverse voltage which will permit safe operation at normal current in a room of average temperature.

The peak current rating is based on an electron flow from the filament which will give a filament life of 1000 hours or more. In the high-vacuum types the tube voltage drop depends upon the current; the higher the current the greater the voltage drop. High-vacuum tubes therefore tend to protect themselves under overload, because excessive current causes a larger voltage drop which in turn reduces the voltage across the load circuit, thus limiting the current flow. In mercury-vapor rectifiers, however, the voltage drop is substantially constant for all values of current, hence the rectifier cannot protect itself from overloads. A heavy overload on a mercury-vapor rectifier, even though instantaneous, is likely to destroy the filament or cathode of the tube, because under such conditions the positive ions of the mercury vapor are attracted to the cathode with such force as actually to tear off the emitting material with which the cathode is coated. A less drastic overload applied over a longer period of time will have the same effect. Mercury-vapor rectifiers should always be worked within the peak current ratings if normal tube life is to be expected.

Standard types of rectifier tubes are listed in

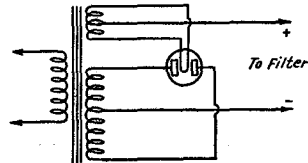

FIG. 1503 — HOW FULL-WAVE TUBE RECTIFIERS ARE CONNECTED

This diagram can be used with Type 80, 82 and 83 rectifier tubes.

the table in Chapter 5, together with their ratings and a brief description of each type. In the smaller sizes, the tubes are generally manufactured as full-wave rectifiers; that is, a cathode and two plates are provided in one bulb so that full-wave rectification can be obtained with a center-tapped transformer. Tubes for high voltages are always half-wave rectifiers; two of them are needed for the center-tap system.

The principal advantages of the mercury-vapor rectifiers over the high-vacuum type are the lower voltage drop and the fact that this drop is independent of the load current. In all

## Power Supply Equipment

the mercury-vapor tubes the voltage drop can for practical purposes be considered to be 15 volts regardless of load current. This low, constant drop results in a power supply having better voltage regulation — discussed in a later section — than one using high-vacuum rectifiers, and is responsible for the wide use of mercury-vapor rectifiers in amateur transmitting equipment. The most popular rectifier tubes are the 82, 83, and 866. Occasionally high-power transmitters employ 872 rectifiers.

Mercury-vapor rectifiers always should be operated with the rated voltage applied to the filament. If the filament voltage is low (filament or cathode temperature too low) the effect is exactly the same as though the tube was heavily overloaded, and the cathode will rapidly lose its emission. For this reason, in operating high-voltage mercury-vapor rectifiers the filament power always should be applied for at least 30 seconds before the plate voltage is turned on so that the filament will be certain to reach its correct operating temperature. If the rectifiers have been out of service for some time it is also advisable to heat the filaments for 10 or 15 minutes before applying plate voltage so that all the mercury that may have condensed on the filament will be vaporized.

Filament voltage should be measured right at the socket terminals, not at the transformer, when tubes such as the 866 and 872 are used because of the heavy filament currents taken by these tubes. It is also advisable to pick out a socket which will make very good contact with the tube pins and also to make sure that the socket is capable of carrying the current.

In attempting to use both plates in parallel in 82 and 83 rectifiers, it is sometimes difficult to get the load to divide evenly between the two halves of the rectifier. Generally one of the plates will take all the load and the other will not "start." This is almost certain to happen if the positive lead is taken off one side of the rectifier filament transformer.

This can be corrected by using a filament center-tap connection or by means of low resistances in series with the plates of the rectifier tubes as shown in Fig. 1502. In *A* a low resistance filament rheostat is connected between the rectifier plates while a fixed resistance of 50 to 100 ohms is used in series with each rectifier plate in *B*.

### Rectifier Circuits

● The elementary rectifier circuits of Fig. 1501 are shown in practical form in Figs. 1503

and 1504. Fig. 1503 is the center-tap circuit for use with a full-wave rectifier tube, and is used only for low-voltage power supplies — 500 volts or less. Both center-tap and bridge circuits are given in Fig. 1504, half-wave rectifier tubes being used in both cases.

Using the same plate transformer, approximately twice the voltage output of the center-tap circuit may be obtained with the bridge circuit. Four rectifiers and three filament-heating transformers are required for the bridge arrangement, however, and the original maximum current rating of the high voltage

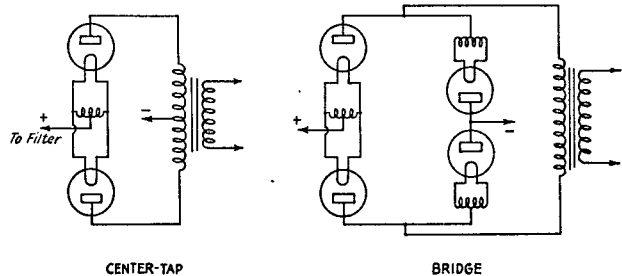

FIG. 1504 — CENTER-TAP AND BRIDGE RECTIFIER CIRCUITS

In both circuits, the peak inverse voltage is equal to the total secondary voltage of the transformer multiplied by 1.4. Therefore, twice as much voltage can be obtained from the bridge as from the center-tap rectifier without exceeding the tube ratings. The tubes will pass the same load current in both cases.

transformer must be halved. A transformer delivering 1000 volts with a maximum current rating of 200 ma. with the center-tap circuit will deliver approximately 2000 volts with the bridge circuit but the maximum current which may be drawn without overloading the transformer will be 100 ma.

Reference to the table of rectifier tubes in Chapter Five will show that the smaller mercury-vapor tubes are rated for a given output current and a maximum r.m.s. applied transformer voltage, while the ratings on the larger tubes are exclusively in terms of inverse peak voltage and peak current. Because of the low voltage at which the small tubes are operated, the ratings for them will hold regardless of the type of filter into which the rectifier works. The 866 and 872, on the other hand, are high-voltage tubes and must be handled with more care; the peak current, which must not exceed the rated value, will depend largely on the type of filter used, while the inverse peak voltage is a function of the transformer voltage and the rectifier circuit. With rectifier tubes having an inverse peak voltage rating of 7500 volts the transformer voltage, in the center-tap circuit, should not exceed 2600 volts each side of the center tap. If the bridge circuit is to be used, the total transformer voltage should not exceed 5200 volts. The corresponding volt-

ages with 10,000-volt tubes are 3500 and 7000 volts. Few amateurs use plate voltages exceeding 3000 volts; the average for high-power amateur transmitters is 2000 to 2500 volts. The high-voltage rectifiers in the table are therefore sufficient for practically all amateur needs.

## Voltage Regulation

● The term "voltage regulation" is used to indicate the change in terminal voltage of a plate-supply system with different load currents. The windings of transformers and filter chokes used in plate supplies all have some resistance; as the current drawn from the power supply is increased the voltage drop in the transformer and chokes also increases with the result that the terminal voltage drops. Besides these ohmic effects, there may be other causes contributing to the decrease in terminal voltage with load, such as the behavior of the filter.

As ordinarily used in electrical engineering, the term "voltage regulation" refers to the increase in voltage resulting when the load current is decreased from the rated value to zero, expressed as a percentage of the terminal voltage at full-load current. It is often more convenient in speaking of plate-supply systems, however, to use the terminal voltage at no load as a base, in which case the per cent. regulation will be the *decrease* in terminal voltage from the no-load value to the value of load at which the power supply is to be worked. Amateur plate supplies are seldom used at a definitely-fixed load current, hence the greater convenience of expressing voltage regulation as a percentage of the no-load terminal voltage.

As an illustration, suppose the measured terminal voltage of a power supply is 1200 volts at no load — i.e., no current being drawn by the transmitting tubes. Then with the transmitter in operation the voltage is measured and found to be 900 volts. The voltage regulation will be

$$\frac{1200 - 900}{1200} = .25 \text{ or } 25\%$$

The voltage regulation will be found to vary with the load and with the type of filter used. Good plate supplies will have a regulation of the order of 10% or less; poorly-designed power supplies often have regulation as high as 50% — in other words, the voltage at full load drops to half its no-load value. Good voltage regulation is highly desirable with the self-controlled transmitter because in such a transmitter the frequency depends upon the plate voltage; if the plate voltage dives suddenly every time the key is pressed the note will have a chirpy or "yooping" character and be hard to read. While this consideration is not as important in

the amplifier stages of oscillator-amplifier transmitters, good voltage regulation is still desirable because it tends to reduce key thumps.

## The Filter

● The filter is a very important section of the power supply. Primarily its purpose is to take the electrical pulses from the rectifier (see Fig. 1501) and smooth them out so that the power delivered to the plates of the transmitting tubes is perfectly continuous and unvarying in just the same way that the current from a battery is continuous and unvarying. But in addition to this, the design of the filter will greatly affect the voltage regulation of the power supply and the peak current through the rectifier tubes.

In analyzing the output of a rectifier-filter system, it is customary to consider the output voltage to consist of two components, one a steady "pure d.c." voltage and the other a super-imposed a.c. voltage — the ripple voltage — which when combined with the assumed unvarying voltage gives the same effect as the actual rapid variations in the output of an incompletely-filtered power supply. When the r.m.s. or effective value of the ripple voltage is divided by the d.c. voltage the result, expressed as a percentage, gives a "figure of merit" (per cent. ripple) for comparing the performance of various filter circuits; furthermore, the amount of filter needed for various transmitter applications is dependent upon the ripple percentage that can be tolerated. Experience has shown that a ripple of 5% or less will give "pure d.c." for c.w. telegraphy if the transmitter has high frequency stability; for radiotelephony the ripple should be .25% or less to reduce hum to a satisfactory level.

Filters are made up of combinations of inductance and capacity — chokes and condensers. Although there are several ways of considering the operation of chokes and condensers in the filter, possibly the simplest is from the standpoint of energy storage as discussed in Chapter Three. Both chokes and condensers possess the property of storing electrical energy, the former in the form of the electromagnetic field, the latter in the dielectric field. While the amplitude of the rectified a.c. wave is increasing, energy is stored in both the inductance and capacity; after the peak has been reached and the amplitude of the rectified wave begins to decrease, the stored-up energy is released and fills in the valleys between the rectified humps. A little consideration of the action will make it evident that the energy storage required will depend upon the rate of occurrence of the rectified waves; the closer they are together the less will be the



## Power Supply Equipment

energy storage required. In other words, the amount of inductance and capacity needed will be inversely proportional to the frequency of the a.c. supply. A supply frequency of 60 cycles with full-wave rectification gives 120 rectified waves per second, corresponding to a frequency of 120 cycles. Similarly, full-wave rectification with 50-cycle supply gives a frequency of 100 cycles, and with 25-cycle supply a frequency of 50 cycles. The discussion to follow is based on full-wave rectification with 60-cycle supply; to maintain a given ripple percentage at the lower frequencies both

plate supply for an amateur transmitter must be adequately filtered. The arrangement at *B* (the "brute force" filter) is a popular one; with suitable values of *L* and *C* the smoothing will be adequate for most amateur purposes. This is known as a condenser-input filter because a condenser is connected directly across the output of the rectifier. The condenser-input filter is characterized by high output voltage, poor voltage regulation and high rectifier peak current.

A third type of filter is shown at *C*. It consists of a single choke and condenser, and because the rectifier output goes to the choke, is known as a choke-input filter. Chief characteristics of the choke-input filter are good voltage regulation and low rectifier-tube peak current; for a given transformer voltage the output voltage will be lower than from the condenser-input filter over most of the load range, however. The choke-input filter is the only type whose performance can be calculated accurately; there is no simple method of predetermining the performance of a condenser-input filter. The filter at *D* consists of two filters of the *C* type connected in series; this more elaborate arrangement is known as a two-section filter and is used to obtain greater smoothing than can be gotten economically with the single-section filter. Because of the many advantages of choke-input filters, they will be given detailed consideration in this chapter.

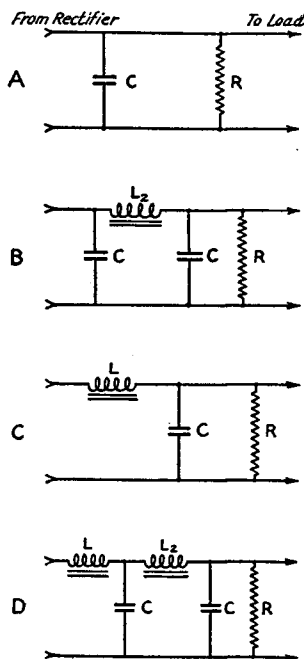

FIG. 1505 — FILTERS

At *A* is the simplest type of filter — a single condenser of high capacity connected across the rectifier output. With the addition of a filter choke and a second condenser this becomes the "brute force" circuit of *B*. *C* is a single-section choke-input filter. The two-section filter at *D* is recommended when the ripple voltage in the output must be low.

inductance and capacity must be increased over the 60-cycle values. The required increases will be directly proportional to 60 divided by the supply frequency.

### Types of Filters

● Inductance and capacity can be combined in various ways to act as a filter. Four representative arrangements are given in Fig. 1505. The single condenser at *A* is not a complete filter, but will give considerable smoothing. This type of filter will not, generally speaking, be sufficient to meet the requirement that the

● As suggested before, the ripple voltage tolerable in the output of the power supply will depend upon the type of service. We can take .25% or less as standard for radiotelephony. The per cent. ripple allowable for c.w. telegraphy will, however, depend upon the design of the transmitter itself. If the dynamic stability of the transmitter is high — that is, if changes in plate voltage cause no noticeable change in the transmitter frequency — a larger ripple voltage can be tolerated without seriously affecting the tone of the transmitter than would be the case with transmitters in which a small change in plate voltage produces an audible change in frequency. As a working rule, we can say that the plate supplies for all oscillators — and especially self-controlled oscillators — should have not more than 1% ripple in the d.c. output. Since filter apparatus for low-power stages — oscillators and buffers in almost all transmitters are low-power — is inexpensive, plate supplies for all low-power stages should conform to the rule of not more than a 1% ripple. For amplifier stages in which frequency modulation is not a factor, the figure of 5% or less ripple will be satisfactory for c.w. telegraphy.

# The Radio Amateur's Handbook . . . . .

To illustrate the method of designing a plate supply, let us go through a specific problem. Suppose that two 203-A tubes are to be supplied 1000 volts of 350 milliamperes; the tubes are to be used in the final amplifier stage of a crystal-controlled transmitter and a ripple of 5% or less will be satisfactory. It can be assumed that for ripple percentages of this order a single section filter such as that in Fig. 1505-C will represent the most economical design; for 1% or less ripple two sections, Fig. 1505-D, should be used. For our particular problem, then, a single-section filter will suffice. The per cent. ripple will depend upon the product of the choke inductance and condenser capacity; the following formula gives the ripple percentage directly:

$$\% \text{ ripple} = \frac{100}{LC}$$

where  $L$  is in henrys and  $C$  in microfarads. Transposing, we find that the product of  $LC$  must be 20 or more to result in 5% or less ripple.

The most economical filter design will be that in which choke cost is balanced against filter-condenser cost to give the required total of inductance and capacity. There are other considerations, however, which must be taken into account before the constants of the filter can be determined upon. These have to do with the functions of the input choke in the filter system.

## The Input Choke

● Upon the input choke falls the burden of improving voltage regulation and reducing rectifier peak current as well as contributing to the smoothing. The inductance required in the input choke to maintain a constant output voltage and a reasonably low peak current depends upon the load to be placed on the power-supply system; i.e., the amount of current to be drawn. The load on the system can be expressed in ohms, and is equal to the output voltage divided by the total load current in amperes. The optimum value of input-choke inductance is equal to

$$L_{opt.} = \frac{\text{Full-load resistance in ohms}}{500}$$

With an input choke having optimum inductance, the rectifier peak current will not exceed the d.c. output current by more than 10%; in other words, the current from the plate-supply system can approach 90% of the peak-current rating of one tube in the full-wave rectifier without danger to the tubes.

To maintain the output voltage at a constant value, it is necessary to have some load on the plate-supply system at all times. If

there is no load at all on the system, the filter condensers will charge up to the peak value of the rectified a.c. wave; the peak of this wave is approximately 1.4 times the r.m.s. or rated transformer voltage. To keep some load on the system at all times a bleeder resistor,  $R$  in Fig. 1505, is used. Since it is desirable to keep down the amount of power dissipated in the bleeder, a fairly high resistance is ordinarily used; usual practice is to make a bleeder take 10% or less of the full load current. The bleeder resistance will therefore be much higher than the resistance of the total load, which includes the load represented by the transmitting tubes and that of the bleeder itself. The critical value of input choke inductance which will prevent the d.c. output voltage from rising to the peak of the rectified wave is equal to

$$L_{crit.} = \frac{\text{Resistance of bleeder in ohms}}{1000}$$

With this value of input choke the rectifier-tube peak current will be greater than with optimum choke inductance, but with only the bleeder as a load the current will be low and no harm will be done to the tubes.

Since the no-load current (bleeder only) will usually be only one-tenth the full-load current, it is evident that these two formulas will give widely different values for input choke inductance; in fact, the critical value of inductance will be about five times that of the optimum value. It should be pointed out that both these values represent the *minimum* input choke inductance that should be used; some improvement will result if the inductance is increased, although the improvement will be slight in comparison to the extra cost. A choke having the critical inductance value can therefore be used with entirely satisfactory results, but it is more economical to use a "swinging" choke whose inductance varies from the critical value at no load to the optimum value at full load; such chokes are available from manufacturers.

Returning now to the specific problem in hand, it will be found after consultation of manufacturers' catalogs that swinging chokes capable of carrying the desired load current can be obtained with an inductance swing of 5 to 25 henrys. Based on the critical value of 25 henrys, the bleeder resistance should be  $25 \times 1000$ , or 25,000 ohms; the bleeder therefore will take 40 milliamperes. The power dissipated in the bleeder will be  $1000 \times .040$ , or 40 watts; a resistor having this or larger power-dissipation rating should be used. The full-load inductance value of 5 henrys should be used in the calculation for per cent. ripple. We have previously determined that the product of inductance and capacity must be at least

## Power Supply Equipment

20 for 5% or less ripple, so that the required condenser capacity will be 20/5, or 4 microfarads. A greater capacity will give a correspondingly smaller ripple voltage.

After the size of the filter condenser and choke have been determined, it is necessary to ascertain whether the particular combination chosen will be such as to resonate at or near the ripple frequency. If the combination should through accident be resonant, the operation of the plate supply system is likely to be unstable and the smoothing will be impaired. The resonance frequency will be equal to

$$f_{res.} = \frac{159}{\sqrt{LC}}$$

where  $L$  is in henrys and  $C$  in microfarads, and should be well below the supply-line frequency. In our example, the resonance frequency by the formula above is approximately 35 cycles, so the filter design is satisfactory from this standpoint.

### Calculating the Required Transformer Voltage

● After the filter has been decided upon, the next step in the design of the power supply system is to select suitable rectifier tubes and determine the necessary ratings of the power transformer. For a plate supply of the type we have been considering, the logical rectifier tube is the 866; a pair of them can be used in the center-tap circuit, or four of them can be connected in bridge. Since the voltage is well below the inverse peak ratings of the tubes, it is probably more economical to use the center-tap circuit. The transformer must be capable of handling the same amount of power with either type of rectifier, so that the cost of the power transformer will not be a deciding factor in the choice of the rectifier circuit. Assuming that the center-tap circuit is to be used, we are now ready to determine the secondary voltage required to ensure having 1000 volts at the power supply terminals under full-load current.

To find the secondary voltage needed, the voltage drops in the system at full-load current must be calculated. To do this it is necessary to know the resistance of the filter choke. The type of choke we have been considering probably will have a resistance of about 50 ohms; the voltage drop in it at full load will therefore be  $50 \times .375$ , or approximately 18 volts. There will be an additional drop in the rectifier tubes; we have only to consider one tube, however, since only one works at a time. This drop is approximately 15 volts. The total is therefore 33 volts, which added to 1000 gives 1033 volts as the average value of the a.c. voltage from one side of the transformer secondary. Transformers are rated in effective or r.m.s. voltages,

however, so to find the required voltage in r.m.s. values it is necessary to divide the average value by .9. The required secondary voltage therefore will be 1033/.9 or 1150 volts. The general formula for determining transformer voltage is

$$\text{Sec. } E_{rms} = \frac{E_o + IR_c + E_t}{.9}$$

where  $E_o$  is the d.c. output voltage of the power supply,  $I$  is the full-load current, including the bleeder current,  $R_c$  is the resistance of the choke or chokes in the filter, and  $E_t$  is the voltage drop in one rectifier tube in the center-tap circuit, or the sum of the drops of two tubes in the bridge circuit.

If the design principles given in the preceding discussion have been followed through, the required secondary volt-amperes will be

$$\text{Sec. VA} = \text{Total } E_{rms} \times I \times .75$$

where  $I$  is the d.c. output current, and  $E_{rms}$  is the total secondary voltage (both sides of center-tap). In our illustration, the secondary VA capacity required therefore will be  $2300 \times .375 \times .75$ , or 650 VA. The actual watts drawn from the transformer will be less than this figure, but a somewhat higher VA capacity is required because the rectifier-filter system distorts the secondary-voltage wave-form, and it is necessary to take this into account in computing the heating effect of the current in the secondary winding. Because the heating effect is greater than in ordinary transformer applications, additional VA capacity must be built into the transformer.

In purchasing a transformer, it should be borne in mind that standard designs do not always fit exactly an individual problem. It therefore becomes necessary to select a transformer with ratings which fit the desired ones as closely as possible.

The d.c. output voltage which may be obtained from a given transformer with given rectifier tubes and filter chokes may be obtained by rearranging the preceding formula as follows:

$$E \text{ (output)} = .9 E_{rms} - IR_c - E_t$$

### Greater Smoothing

● In the specific design problem just used as an illustration, the permissible ripple voltage was assumed to be 5%. As we have pointed out previously, this will be satisfactory when the plate supply is to be used on the amplifier stages of an oscillator-amplifier transmitter used exclusively for c.w., but the ripple voltage must be smaller for self-controlled transmitters and radio-telephone sets. The most satisfactory way to get the additional smoothing is to use the two-section filter shown at

# The Radio Amateur's Handbook . . . . .

Fig. 1505-D. The per cent. ripple for a two-section filter is found by the following formula:

$$\% \text{ Ripple} = \frac{650}{L_1 L_2 (C_1 + C_2)^2}$$

For 1% ripple, satisfactory for oscillators, the numerical value of the denominator must therefore be at least 650; for .25% ripple, satisfactory for radiotelephony, the denominator must be at least 2600. The ripple in the power supply design previously discussed can be reduced considerably simply by the addition of a smoothing choke (not the swinging type) having an inductance of about 8 henrys, and a second 4- $\mu$ fd. condenser at the filter output terminals. Substituting these values in the formula above will give a ripple of approximately .25%. The two-section filter will have better voltage regulation and will require less inductance and capacity than a single-section filter having equivalent smoothing. The voltage drop in the second choke should be included in the calculation for determining the required transformer secondary voltage. If the design data given above are followed carefully, the voltage regulation of the power supply will be less than 10% — a very good figure.

## Condenser-Input Filters

● The great advantages of the choke-input filter in reducing rectifier-tube peak current and in making possible good voltage regulation have been pointed out in the preceding discussion. These two points are of utmost importance in high-voltage plate-supply systems. The life of the rectifier tube is determined by the peak current it has to pass, while poor voltage regulation makes it necessary to buy filter condensers rated for the maximum voltage that is likely to appear across the condenser terminals. The cost of filter condensers goes up at a rapid rate as the voltage increases.

For low-voltage plate supplies — 500 volts or less — these considerations are of less economic importance. The smaller rectifier tubes, besides being inexpensive, are rated to work into either choke- or condenser-input filters; low-voltage filter condensers also are inexpensive. Plate supplies for low-power transmitters are often built around a power transformer of fixed design (transformers giving 350 and 550 volts each side of the center-tap are legion) and in such cases the requisite smoothing is often obtained most economically by using a condenser-input filter. No simple formulas are available for computing the per cent. ripple with a condenser-input filter, but experience has shown that a filter of the type shown in Fig. 1505-B will have excellent smoothing if each condenser is 2 to 8  $\mu$ fd. and if the choke has an inductance (commercial

rating) of 20 to 30 henrys. With the condenser-input filter, the d.c. output voltage tends to be greater than the r.m.s. output voltage of the transformer secondary; at very light loads the output voltage will be approximately 1.4 times the secondary voltage (approaching the peak value of the rectified a.c. wave) gradually decreasing with load until at the nominal output rating of the transformer, the d.c. output voltage will be approximately equal to the secondary r.m.s. voltage. This characteristic is of value in low-power sets where the highest output voltage consistent with the power-supply apparatus used is wanted.

The large change in voltage with load represents poor voltage regulation and possibly may result in a chirpy signal from the low-power self-controlled oscillator. It has no such effect with the oscillator-amplifier transmitter, and therefore can be tolerated. The filter condensers, however, must be rated to stand continuously the *peak* value of the voltage — 1.4 times the rated secondary voltage of the transformer. This means that the filter condensers for a 350-volt transformer must be rated at at least 500 volts; those for a 550-volt transformer at at least 800 volts. With condenser-input filters the chief function of the bleeder resistor is to discharge the filter condensers when the power is turned off and thus prevent accidental shocks, because filter condensers will hold a charge for a long while. A resistor of 15,000 to 30,000 ohms is customary for low-voltage plate supplies, the higher resistances being used for the higher voltages.

## 25- and 50-Cycle Supply

● The filter design data just given is, as previously mentioned, applicable only to full-wave rectifiers working from a 60-cycle supply line. For lower frequencies, both inductance and capacity must be increased in proportion to the decrease in frequency to maintain the same reduction in ripple. After following through the design for 60 cycles, the inductance and capacity values obtained should both be multiplied by 2.4 to obtain the values necessary for 25 cycles; for 50 cycles the multiplying factor is 1.2. In practice, the 60-cycle design usually will be found to be adequate for 50 cycles as well.

## Filter Chokes

● The inductance of a choke will vary with the current through it and with the value of the ripple voltage impressed on it in the filter; inductance decreases with increasing direct current and with decreasing ripple voltage. In purchasing a choke information should be obtained as to its actual smoothing inductance at full d.c. load current and at the ripple voltage

## Power Supply Equipment

at which it is to work. The latter requirement can be expressed more simply by determining whether the choke is to be used as an input choke or as a smoothing choke (second choke) in a two-section filter. Input chokes usually are of the swinging variety.

Most of the small chokes obtainable from radio dealers are given a commercial rating of 20 or 30 henrys. This rating is meaningless unless the conditions under which the choke's inductance was measured are stated. Fortunately the smaller chokes are inexpensive and usually have enough inductance to work quite well in condenser-input filters; it is better, however, to buy a choke of good make than to trust to luck with a cheap, but unknown, product.

Filter chokes for high voltages should in every case be purchased from a reputable manufacturer. It must be realized that the design formulas given previously are based on *actual* inductance under load conditions; an over-rated choke will nullify the calculations and probably lead to an entirely different order of performance.

Specifications for building chokes at home are given in a table at the end of this chapter. The design data apply particularly to smoothing chokes; if a choke having an inductance equal to the critical value is chosen for the input choke the results will be satisfactory, although such a choke will not be as economical of materials as a properly-designed swinging choke. The design of swinging chokes to fulfill predetermined conditions is a difficult problem and is beyond the scope of this *Handbook*.

### Filter Condensers

● Two types of filter condensers are commonly available: electrolytic condensers, and condensers using paper as the dielectric. In electrolytic condensers, the dielectric is an extremely thin film of oxide which forms on aluminum foil when the foil is immersed in a suitable electrolyte and is subjected to a d.c. voltage of the proper polarity. Electrolytic condensers are characterized by high capacity for a given size and cost, but cannot be made in single units for very high voltages, 500 volts being about the limit under present conditions. Electrolytic condensers are made in two types, "wet" and "dry." The "wet" condensers are provided with a liquid electrolyte in a sealed container; in the "dry" type the electrolyte is mixed with a filler to form a paste which is then placed between strips of aluminum foil. In neither type is the dielectric a perfect insulator; there is always an appreciable current flow between the electrodes, although it is only of the order of a few milliamperes. This leakage current is greater with the wet than with the dry types; the wet condensers, however, can

stand voltage overloads better than the dry types because excessive voltage will simply increase the leakage current. Excessive voltage applied to the dry type will result in a "blown" condenser which must be replaced. Either type of electrolytic condenser will be satisfactory for condenser-input filters used with transformers delivering 350 volts each side of the center tap. Electrolytic condensers can be obtained in various capacities; 8  $\mu$ fd. is a popular size.

If the maximum voltage of the power supply is greater than the rating of a single electrolytic condenser, two or more units may be placed in series to handle the higher voltage. When condensers are connected in series all the units of the string should have the same capacity so the voltage will divide equally between them. As a further assurance that each condenser in the string will take a proportionate share of the voltage, resistors may be connected across the individual units as shown in Fig. 1506. Each of

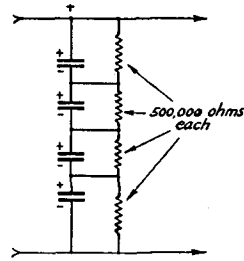

FIG. 1506 — HOW EQUALIZING RESISTORS ARE USED WITH FILTER CONDENSERS CONNECTED IN SERIES FOR HIGH VOLTAGES

the resistors should be 500,000 ohms, and should be rated to dissipate one or two watts.

Electrolytic condensers are suitable for use only in d.c. circuits, and must be connected correctly. In the types having a metal container, the container usually is the negative terminal while the stud terminal is positive. In any event the polarities are always plainly marked. Reversing the polarity will ruin the condenser.

If electrolytic condensers are allowed to stand idle for a time, the dielectric film will gradually disappear and the condenser must be "reformed." To prevent damage to the condensers and other power-supply components, the voltage always should be lowered before application to a power supply after it has been out of service for a few weeks. The film will re-form after a few minutes of low-voltage operation.

Paper condensers also are made in two types, with and without oil impregnation of the paper dielectric. The oil-impregnated condensers generally are suitable for higher voltages than the plain types. Condensers having a

# The Radio Amateur's Handbook . . . . .

working-voltage rating equal to the highest output voltage of the power-supply system (see discussion on condenser-input filters) always should be purchased. Paper condensers can be purchased with voltage ratings up to 3000 volts and more. High-voltage condensers always should be purchased from reputable manufacturers; it does not pay to "economize" by buying a cheap high-voltage condenser. Although the first cost of a good condenser may be higher, it will last indefinitely if not abused. Poor condensers may work for a time,

but eventually will "blow" and have to be replaced. Failure of a high-voltage condenser may also mean the destruction of the rectifier tubes.

## The Filament Supply

● The second division of the power supply for the transmitter is the supply to the filaments of the tubes used. Though batteries are sometimes used for this supply, alternating current obtained from the house current through a step-down transformer usually is more practical and more satisfactory. In some cases the filament-supply winding is wound over the core of the high-voltage transformer, thus eliminating the necessity for a separate filament transformer. This practice, however, is not always to be recommended. The filament supply must be constant if the transmitter is to operate effectively, and with both filament and high-voltage supplies coming from one transformer this constancy is obtained only with great difficulty, since changes in the load taken from the high-voltage winding cause serious changes in the voltage obtained from the filament winding — unless the transformer is operating well under its rating or unless special compensating apparatus is employed. Wherever possible the high-voltage and filament transformers should be separate units operating, if it can be arranged, from different power outlets, particularly with transmitters using tubes larger than the Type 10.

Examination of any of the power-supply circuits will make it obvious that the filaments of the rectifier tubes must be well insulated from the filaments of the oscillator tubes. The filaments of the rectifiers provide the positive output lead from the plate-supply system while the filaments of the transmitter tubes are connected to the negative side of the high-voltage supply. The fact that the two filament supplies must be insulated does not, however, mean that two transformers are required. The two windings can be on the same core, the necessary insulation being provided between them. Should the filament transformer be bought and should it have no windings suitable for the filaments of the rectifiers, an extra winding usually can be fitted without difficulty. For 866 rectifiers two No. 12 gauge wires in parallel should be used for the winding, the number of turns being determined by the "cut and try" method. With most transformers only a few turns will be necessary to give the required voltage. The rectifier-filament winding can be center-tapped or a center-tapped resistor can be used across it in the manner

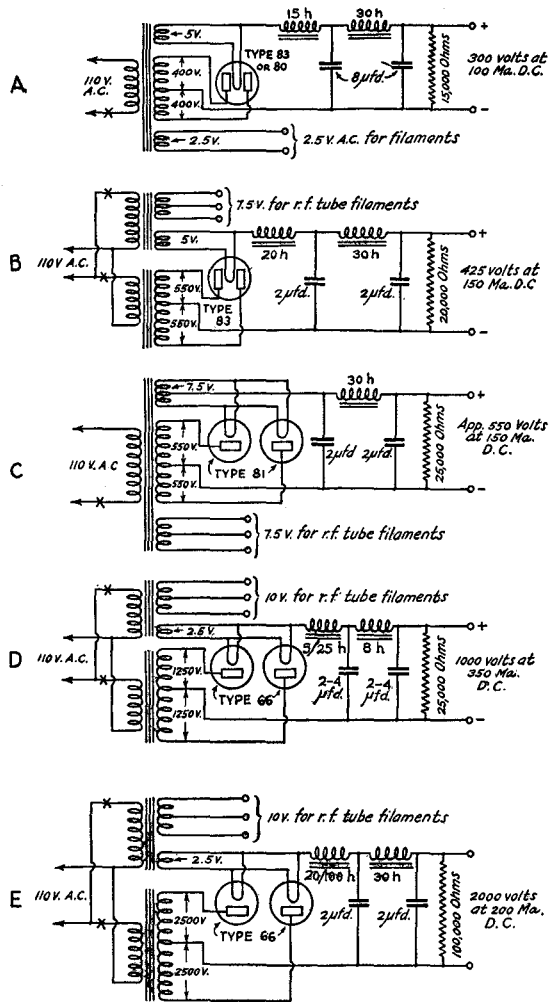

FIG. 1507 — REPRESENTATIVE POWER-SUPPLY ARRANGEMENTS FOR DIFFERENT TYPES OF TRANSMITTING TUBES

All these diagrams will give adequately-filtered d.c. output for the different classes of service. They are explained more fully in the text. Many other arrangements are possible. Control switches should be inserted in the transformer primaries at the points marked "X" to permit the filament supplies to be turned on before the plate supply.

## Power Supply Equipment

described for the transmitter filaments. The center-tap is not an absolute necessity, however; the positive high-voltage lead can be taken from either side of the rectifier filament winding instead.

### Practical Power Supplies

● The wide varieties of rectifying and filtering equipment available to amateurs, together with the different classes of service for which power supplies may be used, make it almost impossible for us to show complete constructional details of such equipment for any but the simplest of transmitters. The foregoing information should enable the amateur to choose the type of rectifier and filter best suited to his

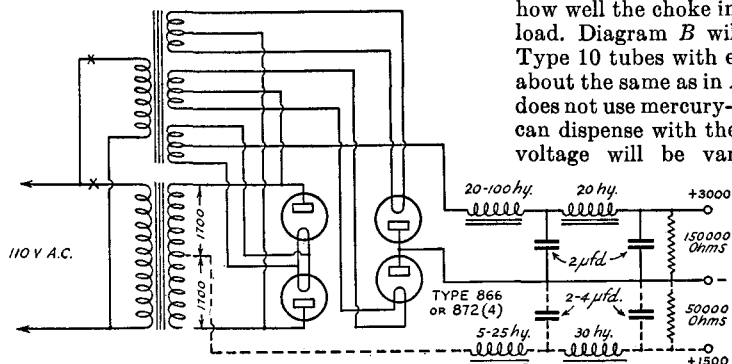

**FIG. 1508—HIGH POWER BRIDGE RECTIFIER CIRCUIT**

When the center-tap filter shown in dotted lines is used, a tap at half maximum voltage with good regulation is provided. The total current drawn from both taps should not exceed 300 ma. for 866's or 1600 ma. for 872's.

needs. As a guide in construction, however, Fig. 1507 shows a number of rectifier-filter combinations to give various output voltages and currents. All will give adequately-filtered direct current to the transmitting tube, and in the cases where mercury-vapor rectifier tubes are shown the necessary protection is afforded them by the use of an input choke to the filter. In all circuits except that at *C* the voltage regulation will be good so that the voltage at no load will not be very much higher than at the load currents indicated. In these cases the filter condensers need be rated to stand only the voltage delivered by one-half of the high-voltage secondary; for example, a condenser with a working-voltage rating of 1250 volts d.c. will be ample for the 1000-volt power supply shown at *D*. This assumes, of course, that the bleeder resistance is used. Without this resistor, the condensers should be rated to stand 50% more voltage than half the secondary voltage of the transformer. In the arrangement at *C* the condensers should have the

higher rating whether the bleeder is used or not.

The input choke may be omitted in diagram *A* even though the small mercury-vapor rectifiers are used because the tubes are built to stand working into a condenser-input filter. Should this be done, however, the filter condensers must be rated at 600 volts working, which means that electrolytic condensers cannot be used unless two of them are put in series to replace the single condensers shown. The condensers need not have 8  $\mu$ f. capacity each, but this is a standard size with electrolytic condensers and is recommended.

The rectifier-filter system at *A* will handle a small transmitter using receiving-type tubes. The ripple will be  $\frac{1}{4}$ % or less, depending upon how well the choke inductance holds up under load. Diagram *B* will take care of a pair of Type 10 tubes with ease; the ripple should be about the same as in *A*. The rectifier-filter at *C* does not use mercury-vapor rectifiers and hence can dispense with the input choke. Its output voltage will be variable between approximately 750 and 550 volts, however, depending upon the load current. It will be suitable for a pair of Type 10 tubes if it should be thought desirable to run them at more voltage than can be obtained

with Diagram *B*. At *D* is shown a power supply for one or two tubes of the 203-A, 211 or 845 type. It is practically the same thing as the illustrative problem previously discussed. The arrangement at *E* is suitable for use with one or two 852 or 860 tubes. With the filter values shown the ripple will be .25% or less.

The circuit of Fig. 1508 is of the bridge type. By using the additional tap and filter system indicated by the dotted lines, a half voltage tap with good voltage regulation may be obtained. The total load current should be limited to 300 ma. if type 866's are used or 1600 ma. if type 872's are used. When the total load current does not exceed the rated values, the combination of low and high voltages makes a convenient arrangement for a high power final amplifier and its driver. This power supply using the values given will be suitable for operating a pair of 852's, 150-T's, one or two 861's or other tubes operating at 3000 volts with a driver tube operating at 1500 volts. This type of circuit provides much better voltage regulation at the half-voltage tap than an arrangement in which the low voltage is obtained from a tap on a voltage divider resistance. This same principle may be applied with benefit to lower voltage supplies. The bridge rectifier using type 83 rectifier

# The Radio Amateur's Handbook . . . . .

tubes described on the following pages is a good example.

In cases where the low voltage required is some value different than one-half of the high voltage value, a scheme such as that shown in

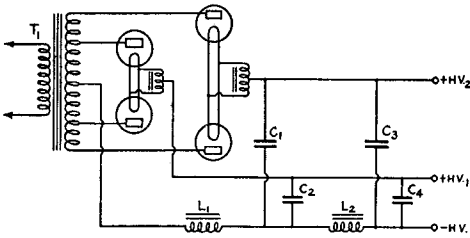

**FIG. 1509 — A POWER SUPPLY CIRCUIT IN WHICH A SINGLE TRANSFORMER AND SET OF FILTER CHOKES IS MADE TO SERVE FOR DIFFERENT VOLTAGES**

*Each voltage has its own rectifier and filter condensers. Although only two voltages are indicated, others may be obtained provided the transformer has the necessary taps.*

Fig. 1509 may be used if a suitable transformer is available.

The cost of the equipment is considerably less since but one transformer and filter is required to produce several different voltages. Compactness is another advantageous feature of the circuit.

The transformer is center-tapped at the various voltages required. These voltages are rectified independently of each other and then filtered through a common filter whose chokes are in series with the center-tap or negative lead from the transformer. Transformers having taps at all the voltages likely to be required may be hard to obtain commercially, especially if more than two voltages are needed. One can be made especially for the job, however, or an old one can be rewound.

The rectifier performance will be improved if the input choke,  $L_1$ , is of the swinging variety instead of the ordinary type. Filter constants are not given since they will depend upon the voltages and currents

to be handled. The chokes must of course be built to handle the total direct current to be taken from all taps on the power supply. Other combinations can be worked out without much difficulty. It is not absolutely necessary to follow exactly the specifications in the filter section of the diagrams; for example 1- $\mu$ fd. condensers or smaller chokes can be substituted in the filter of the high-power plate supply if the big tubes are amplifiers used for c.w. work in a crystal-controlled or oscillator-amplifier transmitter. For 'phone it is better to have as much filter as possible to keep the carrier free from hum.

In all these diagrams it is of course necessary to use power transformers of adequate capacity and chokes of high enough current rating to carry the load currents indicated. In *D* and *E* the plate transformers should be rated at about 650 and 850 VA, respectively, to give the necessary output.

Fig. 1510 is a photograph<sup>4</sup> of a power supply suitable for use with a low-power transmitter. Its circuit diagram, Fig. 1511 will be seen to be similar to A in Fig. 1507 with the exception of the fact that the input choke to the filter is omitted. The filter condenser is a double-unit dry electrolytic condenser having a capacity of 8  $\mu$ fd. per section. The power transformer

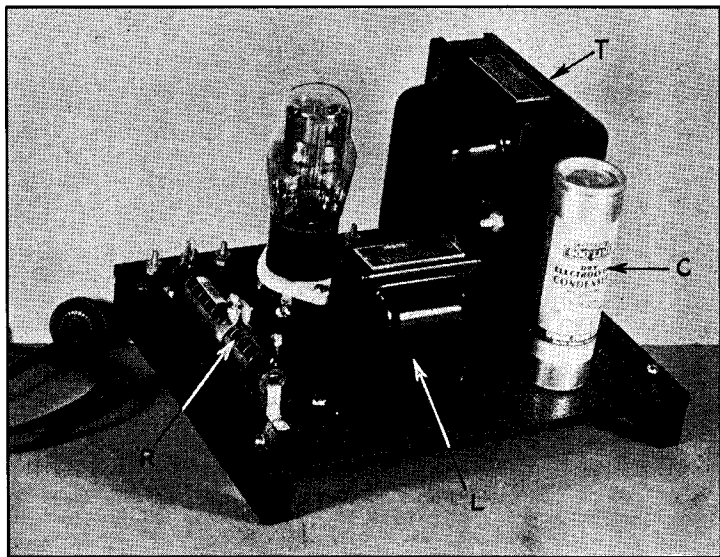

**FIG. 1510 — A 350-VOLT POWER SUPPLY, OF INEXPENSIVE CONSTRUCTION, SUITABLE FOR THE LOW-POWER TRANSMITTER**

- T — Power transformer, 350 volts each side center-tap, 5 volt winding for rectifier filaments, 2.5 volt center-tapped winding for transmitting tube filaments, Thordarson Type T-5604.*
- L — Filter choke, 9.5 henrys at 110 ma. d.c. Thordarson Type T-5754.*
- C — Double filter condenser, dry electrolytic, 8  $\mu$ fd each section, Sprague Type SC-88.*
- R — 40,000 ohm 50 watt adjustable resistor, Ohmite Type 0587.*



# Power Supply Equipment

should deliver not more than 350 volts on each side to avoid damaging the condenser.

The location of parts in a power-supply system is not of great importance. Make certain that the transformer and rectifier tubes are placed so that the heat generated by them can be radiated into the surrounding air, and have all wires, particularly those carrying high voltage, well insulated. In other respects the layout can be made anything convenient.

## A Duplex Plate Supply for the Medium-Power Transmitter

● To illustrate one of the many modifications that can be made to straightforward power-supply design, a diagram of a two-voltage power supply suitable for operating a complete transmitter of medium power is given in Fig. 1512. Inexpensive Type 83 tubes are used in the bridge circuit to give a high voltage of 1000 volts; simultaneously one pair of the tubes acts as a center-tap rectifier in conjunction with the center-tap on the power transformer to furnish 500 volts for the low-power stages of the transmitter. A total of 250 milliamperes (or slightly more, since both filters have choke input) may be taken from the power supply without exceeding the rectifier-tube ratings; a representative current division would be 100 ma. for the small tubes and 150 ma. for the final amplifier stage.

With the filter values indicated in Fig. 1512 the ripple in the 500-volt output will be less than .1% and in the 1000-volt output approximately .25%, so the power-supply will be well suited to use with the r.f. end of a 'phone transmitter. For c.w., the second filter section may be omitted from the 1000-volt section, in which case the ripple will be approximately 6%; increasing the remaining condenser capacity from 2  $\mu$ fd. to 4  $\mu$ fd. will bring the ripple down to 3%. It is best to use the two-section filter on the low-voltage output; the condensers and chokes are relatively inexpensive and low ripple is desirable on low-power stages.

An input choke having fixed inductance is recommended for the 500-volt output because the load on this section usually is continuous. If the load is to be variable, a swinging choke should be used, together with a bleeder of suitable value across the output. The bleeder may be used as a voltage divider to obtain still lower voltage — for instance, for a crystal oscillator.

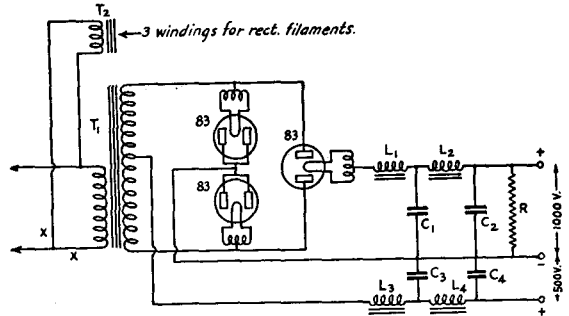

FIG. 1512 — A DUPLEX PLATE SUPPLY CIRCUIT

This plate supply will deliver 500 and 1000 volts at a total of 250 milliamperes (sum of currents from both taps).

- T<sub>1</sub> — Power transformer, 600 volts each side center tap; 350 VA.
- T<sub>2</sub> — Rectifier filament transformer, three 5-volt 3-amp. windings.
- C<sub>1</sub> — 2  $\mu$ fd., 1250-volt rating.
- C<sub>2</sub> — 4  $\mu$ fd., 1250-volt rating.
- C<sub>3</sub>, C<sub>4</sub> — 2  $\mu$ fd., 800-volt rating.
- L<sub>1</sub> — Swinging choke, 8–40 henrys, 275 ma.
- L<sub>2</sub> — Smoothing choke, 12 henrys, 275 ma.
- L<sub>3</sub>, L<sub>4</sub> — 10 henrys, 200 ma.
- R — 40,000 ohms, 25-watt rating.

## Transformers and Rectifiers in Series

● Under certain circumstances, it is sometimes possible to reduce the cost of a high voltage supply by connecting two similar lower voltage supplies or transformer-rectifier units in series. Such a circuit is shown in Fig. 1513. A pair of inexpensive 600 volt, 200 ma. transformers and type 83 rectifiers may be used in this manner to deliver a d.c. output voltage through the filter of about 1000 volts. Since the winding of the transformer on the positive side is at a higher potential than normal, some care should be taken to select a transformer with good insulation. Most transformers of reliable manufacture will have sufficient insulation, at least those with output voltage ratings of 600 volts or less each side of center-tap.

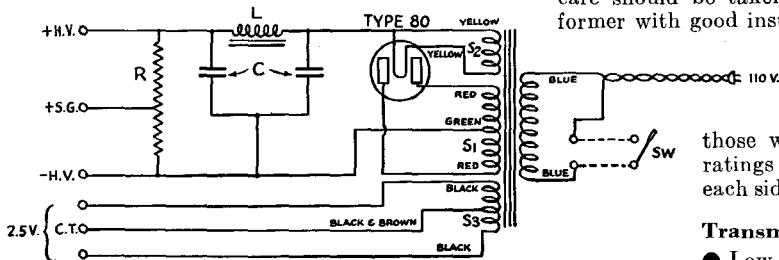

FIG. 1511 — WIRING DIAGRAM OF THE POWER SUPPLY SHOWN IN FIG. 1510

## Transmitter Bias Supplies

● Low-voltage power packs make excellent substitutes for batteries as "C" bias

# The Radio Amateur's Handbook . . . . .

supplies for certain types of r.f. power amplifiers. The "C" power pack, in fact, offers the same advantages as the combination battery-and-leak bias discussed in Chapter Eight. Not all power packs are suitable as bias supplies for transmitters, however.

The power pack for "C" bias use must have a low-resistance bleeder. Since the bleeder, or at least part of it, is connected to the r.f. amplifier grid circuit, it performs in just the

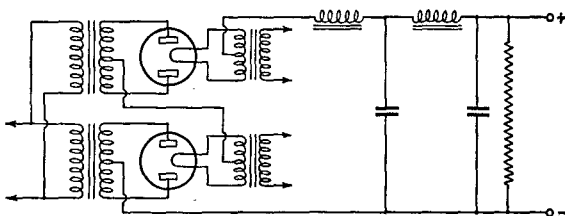

FIG. 1513 — TWO TRANSFORMERS AND RECTIFIERS CONNECTED IN SERIES TO GIVE HIGHER OUTPUT VOLTAGE

same fashion as a grid leak; that is, the flow of amplifier grid current through the bleeder causes a voltage drop which may add considerably to the actual bias on the grid. For this reason, therefore, the part of the bleeder included in the biasing circuit (in case the bleeder provides taps for different voltages) should have a resistance no higher than that ordinarily required as a grid leak for the tube in use. The resistance of the bleeder then can be proportioned so that the voltage across the taps in use will be approximately equal to the cut-off bias of the tube when there is no excitation. This will give the protective feature of fixed bias and also provide the automatic biasing characteristic of grid leaks.

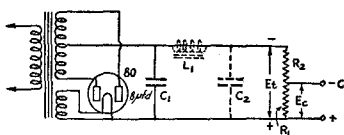

FIG. 1514 — A PRACTICAL CIRCUIT FOR THE "C" SUPPLY

A single 8- $\mu$ fd. condenser often will suffice for the filter, but if trial shows that more is needed, a choke and second condenser, shown in dotted lines, may be added. The condensers should be rated at 500 volts, especially if the "C" supply is to be used on a high-power stage where the excitation is likely to be large.

The bias voltage,  $E_s$ , should be approximately that value which will cut off the plate current of the tube at the plate voltage used (roughly the plate voltage divided by the voltage amplification factor of the tube). Resistor  $R_1$  should be equal to the grid leak value ordinarily used with the tube. The required resistance for  $R_2$  can be found by the formula

$$R_2 = \frac{E_1 - E_s}{E_s} \times R_1$$

where  $E_1$  is equal to the peak value of the transformer-rectifier output voltage (r.m.s. voltage of one side of secondary multiplied by 1.4).

The transformer and rectifier for a bias supply will be identical with those used in receiver power packs. The filter may be somewhat simpler, however; it may, in fact, be found possible to get sufficient filtering with only a condenser connected across the output of the rectifier, since no current except that taken by the bleeder is drawn from the "C" supply. A choke and second condenser can be added in case actual tests show that a bias supply having only a condenser filter introduces modulation on the signal. The circuit diagram of Fig. 1514 is suggested for bias supplies; the method of calculating the bleeder resistance required also is shown.

Since the bias voltage varies with grid current, a "C" supply of this type often will be found to be somewhat unsatisfactory for biasing more than one stage, because the grid current for all stages must flow through the same resistor, thus causing all stages to be overbiased. This effect can be overcome to a considerable extent by using a low bleeder or voltage divider resistance so that voltage variations from grid-current flow are minimized, or by the use of one or more regulator tubes. If some form of regulation is not provided, the bleeder current in such a "C" supply should be just as great as the transformer and rectifier tube are capable of furnishing. The bleeder current for a 300-volt supply, for instance, would be approximately 100 milliamperes, calling for a resistor of about 3000 ohms.

For the reasons given above, "C" supplies without provision for regulation are usually unsatisfactory in applications where the bias voltage must remain constant under operating conditions, as in Class-B audio and r.f. amplifiers. For linear output from these types of amplifiers it is essential that the bias remain constant during operation.

## Bias Voltage Regulation

● As mentioned previously, a vacuum tube in a suitable circuit may be used to provide automatic voltage regulation for a biasing voltage power supply. A circuit which has been used successfully is shown in Fig. 1515. The stabilizer consists of a tube across the output of the power supply in a self-biasing arrangement. The resistor  $R_1$  is on the order of several megohms, so that at no load the tube is biased practically to cut-off. The output voltage is then the total voltage of the supply minus the voltage required to bias the regulator tube to zero plate current. When current flows back through the regulator tube, as would happen if the power supply were being

## Power Supply Equipment

used to bias the grid of a tube which was being driven positive and was drawing grid current, the voltage across the regulator tube will tend to increase. This will cause the voltage across the biasing resistance,  $R_1$ , to decrease. Since the sum of the regulator tube drop and the drop through  $R_1$  must equal the total supply voltage, as the voltage across  $R_1$  decreases the bias on the regulator tube decreases, which causes the tube plate impedance to decrease so

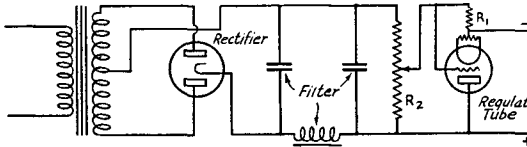

FIG. 1515 — CIRCUIT OF THE AUTOMATIC VACUUM-TUBE REGULATOR AS APPLIED TO A BIAS-OR PLATE-SUPPLY POWER PACK

$R_1$  is the regulator tube's bias resistor and  $R_2$  is the power-pack output voltage divider. A separate filament winding should be used for the regulator. A type 45 tube will be satisfactory as the regulator tube.

that the voltage across it tends to remain constant regardless of the current which is flowing back through it.

As the output voltage is lowered, it may be seen that it becomes necessary to increase the number of tubes in parallel to maintain good regulation, so that at low voltages it would be preferable to use batteries for bias, rather than an a.c. supply with this type of regulator.

The value of the resistor  $R_1$  is not critical, so long as it is large enough to maintain the current drawn from the power supply at a very low value. Any value from a few hundred thousand ohms up to several megohms is satisfactory. The voltage divider  $R_2$  can have practically any value, from a few thousand ohms up, as the current drawn is practically zero.

If additional taps are necessary, a regulator tube with its separate filament transformer will be required for each tap.

### Receiver Power Supplies

● Power supplies for a.c.-operated receivers do not differ materially from those used with transmitters except that the voltages are lower and all ripple must be eliminated. Nothing is more annoying than a "hummy" B supply. The ripple can be reduced to satisfactory proportions by the use of three filter condensers (a three-section electrolytic condenser with capacities of 2, 4 and 8  $\mu$ d. will be satisfactory) and two receiver-type 30-henry chokes. Fig. 1516-A is the wiring diagram of a typical receiver power supply. It uses a power transformer, of the type used in broadcast receivers, delivering approximately 350 volts each side of

the center-tap on the high-voltage winding. This type of power supply will take care of an ordinary amateur receiver and in addition will easily handle an audio power amplifier stage using a 47 pentode or a pair of 45's in push-pull. The output voltage will be rather higher than is required for the receiver itself, however, so the filter may be rearranged somewhat to use choke input, which will reduce the voltage and give better regulation. This is shown in Fig. 1516-B. Alternatively, a transformer giving lower output voltage might be used if the receiver has no power stages and therefore does not take much current.

Special care must be taken with power packs for autodyne receivers to make certain that the voltage output will be

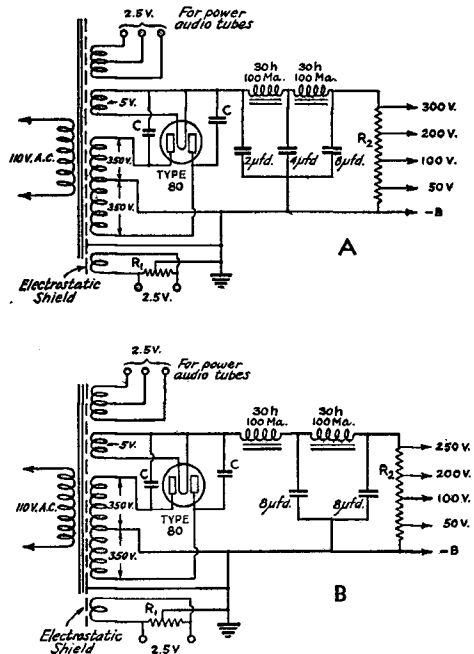

FIG. 1516 — WIRING DIAGRAMS FOR RECEIVER POWER SUPPLIES

Condenser C should be a mica condenser of about .002  $\mu$ d. capacity. Its size is not critical and it will be required only if tunable hums are present, as explained in the text. Resistor  $R_1$  is 20 ohms total, tapped at the center.  $R_2$  is the voltage divider for obtaining different voltages from the power supply. If the receiver itself is equipped with a divider (the preferable method)  $R_2$  will be a simple bleeder of about 15,000 ohms. Otherwise it may be any of the regular voltage dividers sold commercially for this use, or may be a 15,000 ohm resistor tapped at every 3000 ohms. The resistance needed between taps will depend upon the currents to be drawn at each of the taps. It is not usually necessary to have the voltages nearer rated values than within 20%, with modern receiving tubes.

constant and that "tunable hums" do not appear. A varying output voltage will make the detector oscillation frequency change and hence make signals sound wavering and unsteady. The choke-input filter of Fig. 1516-B is recommended on this score; it will

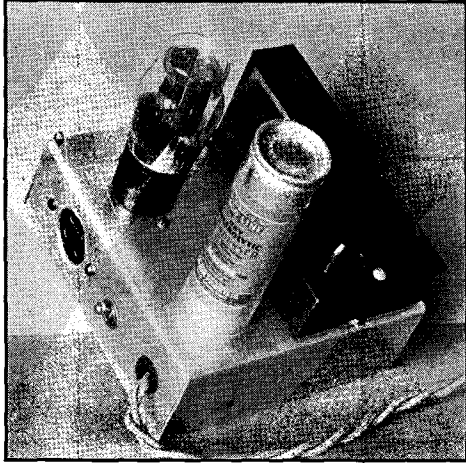

FIG. 1517 — LOW-POWER RECEIVER POWER SUPPLY

be especially valuable if the receiver volume control operates on the bias on the r.f. amplifiers. Tunable hums are hums which appear only at certain frequencies to which the receiver is set and only with the detector oscillating. It may be that no hum can be heard with the detector out of oscillation but a strong hum is noticed as soon as the detector is made to oscillate. This is a tunable hum and cannot be eliminated by the addition of more filter condensers or chokes since it is caused by r.f. getting into the power supply and picking up modulation. Small condensers connected across the plates and filament of the rectifier tube as shown in both diagrams usually will eliminate this type of hum. A grounded electrostatic shield between the primary and secondaries of the power transformer also will help. Not all transformers have such a shield, however. Of course the power leads coming from the receiver itself should be well by-passed to prevent r.f. from getting into the power supply.

For some applications where the current to be taken from the power supply is not more than a few milliamperes — a separate power

supply for a frequency meter, for example — resistors can be substituted for the filter chokes to make a compact power supply. Resistors of 10,000 to 50,000 ohms should be satisfactory, depending upon the voltage drop that is permissible. With a midget power transformer and a low-voltage high-capacity electrolytic condenser, together with one of the smaller rectifier tubes listed in the table, a physically small but adequate power supply can be built.

### Voltage Dividers

● In addition to the voltages shown in Fig. 1507, lower voltages may be taken from any of the power supplies diagrammed by substituting a voltage divider, or tapped resistor, for the plain bleeder resistor. For example, suppose the power supply of Fig. 1507-D is to be used to furnish power for all three stages of a three-tube transmitter (47, 10, 203-A). A voltage divider can be installed to furnish 350 volts at 30 ma. for the oscillator and 500 volts at 60 ma. for the buffer-doubler, in addition to the 1000 volts for the final amplifier.

To calculate the resistance required between taps, the voltage divider should be laid off in sections, as shown in Fig. 1521. Starting from the negative end, the voltage drop across the first section will be 350 volts, the voltage required by the oscillator. The drop across the second section will be 150 volts, bringing the total voltage between negative and the doubler tap to 500 volts. The last resistor section will

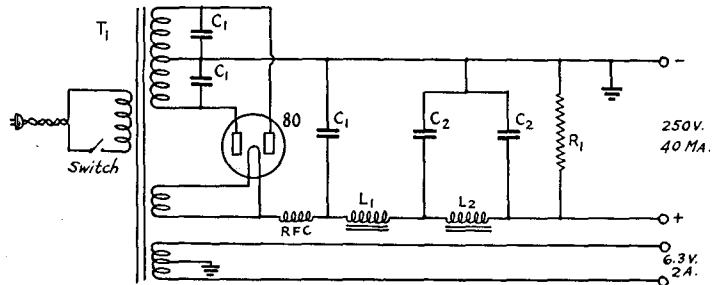

FIG. 1518—A LOW-CURRENT POWER SUPPLY FOR REGENERATIVE OR T.R.F. RECEIVERS

*T<sub>1</sub>* — 275-volt 40-ma. plate winding, 6.3-volt 2-amp. heater winding, 5-volt 2-amp. rectifier winding.

*L<sub>1</sub>-L<sub>2</sub>* — 30-henry 40-ma. chokes.

*C<sub>1</sub>* — .005- $\mu$ fd. 400-volt tubular paper condenser.

*C<sub>2</sub>* — Dual 8  $\mu$ fd. 450-volt electrolytic condensers.

*R<sub>1</sub>* — 50,000 ohm 10 watt resistor.

*RFC* — Receiving type r.f. choke.

2.5-volt heater windings may be substituted, subject to receiver requirements.

have a drop of 500 volts across it. Then, knowing the current to be drawn at each tap and the idle current to be bled off through the low-

## Power Supply Equipment

est resistor section, it is an easy matter to calculate the resistances required at each section by applying Ohm's Law. The power supply Fig. 1507-D calls for a bleeder current of 40 ma. (1000 volts divided by 25,000 ohms); the lower section therefore is equal to

$$\frac{350}{.04} = 8750 \text{ ohms.}$$

The second section has the 30 ma. for the oscillator in addition to the 40 ma. idle current flowing through it, therefore the resistance required is

$$\frac{150}{.07} = 2150 \text{ ohms (app.).}$$

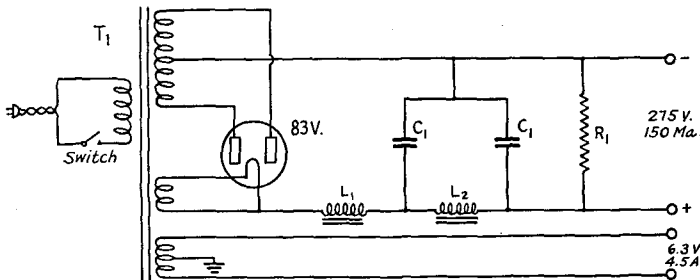

FIG. 1519 — A POWER PACK FOR SUPERHETERO-DYNE RECEIVERS, WITH SUFFICIENT RESERVE FOR SPEAKER FIELD SUPPLY

*T<sub>1</sub> — 300-volt 150-ma. plate winding, 6.3-volt 4.5 amp. heater winding, 5-volt 2-amp. rectifier winding.*

*L<sub>1</sub> — 10-henry 150-ma. choke.*

*L<sub>2</sub> — 20-henry 150-ma. choke.*

*C<sub>1</sub> — Dual 8 μfd. 450-volt electrolytic condensers.*

*R<sub>1</sub> — 50,000 ohm 10 watt resistor.*

*2.5-volt heater windings may be substituted, subject to receiver requirements.*

In the third (upper) section, the current becomes 60 ma. plus the 70 ma. already flowing through the section below, a total of 130 ma. The resistance value is

$$\frac{500}{.13} = 3850 \text{ ohms.}$$

The total resistance of the divider is therefore 14,750 ohms, safely below the value necessary to maintain constant output voltage when the tubes are not drawing current from the power supply. This will increase the no-load bleeder current, but will not affect the operation of the power supply under full load. In the above example, the no-load resistor current will be

$$\frac{1000}{14,750} = 63.5 \text{ ma.}$$

Under no-load conditions the voltage across each resistor will be proportional to its individual resistance compared to the total re-

sistance. The drop across the lower section would be

$$\frac{8750}{14,750} \times 1000 = 600 \text{ volts (app.).}$$

The drop across the middle section is

$$\frac{2150}{14,750} \times 1000 = 150 \text{ volts (app.).}$$

Across the upper section

$$\frac{3850}{14,750} \times 1000 = 250 \text{ volts (app.).}$$

The above calculations make it clear that the voltage regulation of the tap voltages is rather poor, since the voltage rises considerably when the load is removed. This is characteristic of voltage dividers. The output voltages will be correct only when the load currents used in the calculations are drawn.

The power dissipated by each resistor may be calculated by multiplying the voltage drop across it by the current flowing through it. This should be done for both no-load and full-load conditions, and a resistor selected having a rating well above that of the higher of the two values. It may not be possible to get stock resistors of the exact resistance calculated, in which case the nearest available size usually will be satisfactory. Semi-variable resistors, having sliding contacts so that any desired resistance value may be selected, can be used if more exact adjustment of voltage is required.

In case it is desired to have the bleeder resistance total to a predetermined value — for instance, if the bleeder in the illustration above is to total 25,000 ohms instead of the calculated value of 14,750 ohms — the same method of calculation may be followed, but different values of idle current should be tried until the correct result is found. An idle current of 20 instead of 40 ma., for instance, will work out to a total resistance of approximately 25,000 ohms in the illustration above.

The method may be extended to a greater number of taps, and is equally applicable to the calculation of voltage dividers for receivers.

### Portable and Independent Power Supply

As mentioned previously, a series of 45 volt dry batteries totaling 250 to 350 volts may be used to provide plate voltage for low power transmitters. If reasonable battery life is to be expected, the total current load should not exceed a value of about 30 ma. for continuous

# The Radio Amateur's Handbook . . . . .

operation from standard size batteries. In telegraph service this limit might be extended to perhaps 50 ma. Dry batteries are used most frequently for portable transmitters although they are also used successfully in permanent installations of low power.

A series of small "test tube" type storage cells with total voltage outputs of 200 to 500 volts have been used in the past and many may be found in service at the present time. Their disadvantages are that they require means for frequent recharging and they are more or less "messy" to handle. The maximum current which may be drawn with reasonable battery service is limited to 50 or 60 ma. They may be charged by connecting the cells in series-parallel from a 32 volt power plant or from a 110-volt d.c. line.

The increasing use of automobile radio receivers has brought about a revival of the "buzzer" type of transformer to obtain power at a voltage suitable for the plates of tubes from a low-voltage d.c. source such as a storage battery.

Power supplies of this type can be obtained at reasonable cost and will be suitable for transmitters of very low power.

The most dependable type of independent power source is the high voltage d.c. generator or the a.c. rotary converter operating from 110, 32, 12 or 6 volts storage batteries. These are now available with a variety of output voltages and power ratings. They are comparatively expensive, however, and, of course, the storage battery providing the driving power must be recharged frequently.

Some amateurs have been successful in charging two or three 6 volt storage batteries by means of a small d.c. generator driven by a windmill. Such a charging system is described in the issue of *QST* for March 1934.

The only way by which the charging of storage batteries may be eliminated is by the use of a gasoline engine-driven generator. Power plants of this type are available in a variety of power ratings but, of course, are quite expensive.

## Transmitter Operation from 110-volt d.c. Lines

● Where only 110 volt d.c. supply is available, it is recommended that tubes designed especially for this service be used. Transmitters delivering up to 25 or 30 watts output may be constructed using the type RK-100. Such a transmitter was described in *QST* for June, 1935. Otherwise, a high-voltage d.c. generator or 110 volt rotary converter will be required.

### Line Voltage Regulation

● In certain communities trouble is sometimes experienced from fluctuations in line

voltage. Usually these fluctuations are caused by a variation in the load on the line and may be taken care of by the use of a manually-operated compensating device. A simple arrangement is shown in Fig. 1521. A toy transformer is used to boost or buck the line voltage. The transformer should have a tapped secondary varying between 6 and 20 volts in steps of 2 or 3 volts and its secondary should be capable of carrying the full load current of the entire transmitter.

The secondary is connected in series with the line voltage and, if the polarity of the windings is correct, the voltage applied to the primaries of the transmitter transformers can be brought up to the rated 110 volts by setting the toy transformer tap-switch on the right tap. If the polarity of the two windings of the toy transformer happens to be reversed, the voltage will be reduced instead of increased. This connection may be used in cases where the line voltage may be above 110 volts. This method is preferable to using a resistor in the primary of a power transformer since it does not affect the voltage regulation as seriously.

Another scheme by which the primary voltage of each transformer in the transmitter may be adjusted to deliver the desired secondary voltage with a master control for compensating for changes in line voltage is shown in Fig. 1522.

This arrangement has the following features:

1. Adjustment of  $S_1$  to make the voltmeter read 105 volts automatically adjusts all primaries to the predetermined correct voltage.
2. The necessity for having all primaries work at the same voltage is eliminated. Thus, 110 volts can be applied to the primary of one transformer, 115 to another, etc.

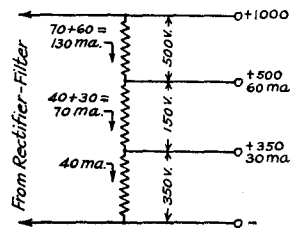

FIG. 1520 — VOLTAGE DIVIDER COMPUTATIONS CAN BE MADE BY PLOTTING THE VOLTAGE DROPS AND CURRENT DIVISION IN A DIAGRAM SIMILAR TO THIS ONE

3. Independent control of the plate transformer is afforded by the tap switch  $S_2$ . This permits power input control and does not require an extra auto-transformer.

The system simplifies the adjustment of various filament voltages, since the primary voltage can be selected over a range of 20 volts or

## Power Supply Equipment

so, and that if these voltages are properly set when the rig is constructed then forever afterward a single adjustment of  $S_1$  takes care of all of them. When filament transformers are home built it is a little difficult to get, for example exactly 10 volts at 6.5 amps without excessive cut-and-try. The expedient of tapping the particular primary along the auto-transformer until the proper voltage is obtained at the filament terminals is most convenient. It is of course presupposed that this adjustment is made after proper regulation of  $S_1$  and after all filament wiring has been finished. Some fifteen taps at  $S_1$  are needed for close regulation, although only a few have been shown for the sake of simplifying the diagram.

The auto-transformer need not be expensive nor even tedious to wind. Ninety per cent. of burned-out broadcast-receiver transformers have a good primary left, and can be picked up for little or nothing at a service shop. If the secondaries are removed and the insulation isn't "shot," the transformer may be connected to the line for a few minutes to see if heating occurs. Usually the high-voltage secondary will be badly charred but the primary will be in good shape. Choose a large transformer (the kind used for ten- or twelve-tube sets or for P.A. systems). A 250-watt unit will handle some 1000 watts in the circuit shown. The voltage per turn can be readily determined, either by counting turns on one of the filament windings of known voltage output, or by winding on a few turns and measuring with a low-

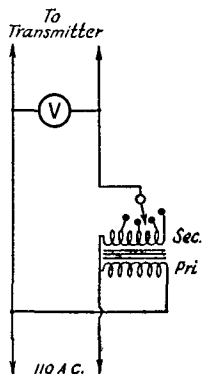

**FIG. 1521 — SIMPLE METHOD OF CORRECTING CHANGES IN LINE VOLTAGE. THE TOY TRANSFORMER WITH TAPPED SECONDARY MAY BE CONNECTED SO AS TO INCREASE OR DECREASE LINE VOLTAGE AS DESCRIBED IN THE TEXT**

range voltmeter. (Measured voltage divided by number of turns equals volts per turn.) This figure divided into the voltage range desired (20 volts is usually sufficient) gives the number of turns on the new winding, shown in

heavy lines in the diagram. The winding is then put on, taps being taken out at suitable intervals — approximately 1.5 volts between each tap. The taps preferably should be staggered

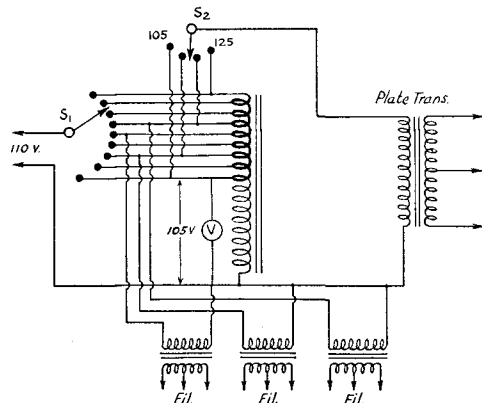

**FIG. 1522 — WITH THIS CIRCUIT, A SINGLE ADJUSTMENT OF SWITCH  $S_1$  PLACES THE CORRECT PRIMARY VOLTAGE ON ALL TRANSFORMERS IN THE TRANSMITTER**

*Information on constructing a suitable auto-transformer at negligible cost is contained in the text. The light winding represents the regular primary of a revamped transformer, the heavy winding the voltage-regulating section.*

along the winding to avoid bunching and to make identification easy. Taps can be made quite easily by slipping a piece of cambric under the turn to be tapped, scraping off the insulation at the desired point, and soldering on a length of stranded rubber-covered wire. No. 10 enamelled wire can be used for the winding; with this size wire and a husky b.c. transformer the regulation from no-load to full-load will be very good.

The plate transformer switch,  $S_2$ , need not have as many positions as the regulating switch,  $S_1$ ; taps at every 5 volts will be ample. The same taps can be used for both switches, of course.

### Building Small Transformers

● Power transformers for both filament heating and plate supply for all transmitting and rectifying tubes are available commercially at reasonable prices, but occasionally the amateur wishes to build a transformer for some special purpose or has a core from a burned-out transformer on which he wishes to put new windings.

Most transformers that amateurs build are for use on 110-volt 60-cycle supply. The number of turns necessary on the 110-volt winding depends on the kind of iron used in the core and on the cross-sectional area of the core. Silicon steel is best, and a flux density of about

# The Radio Amateur's Handbook . . . . .

50,000 lines per square inch can be used. This is the basis of the table of cross-sections given.

An average value for the number of primary turns to be used is 7.5 turns per volt per square

the number of turns per volt and the cross-section of the core gives the best-balanced design.

Most 60-cycle transformers will behave nicely on a 25-cycle supply if the applied voltage is sufficiently reduced. Up to 52 volts at 25 cycles may be applied to a 110-volt 60-cycle winding without harm. Knowing the transformer voltage ratio, the output voltage will be known. The current-carrying capacity will be the same as at 60 cycles. The KVA (kilovolt-ampere) rating will be about half the 60-cycle value.

Having decided on the core cross-section necessary to handle the power, the next step is to calculate the core window area required to accommodate the windings. The primary wire size is given in the table; the secondary wire size should be chosen according to the current to be carried, as previously described. The

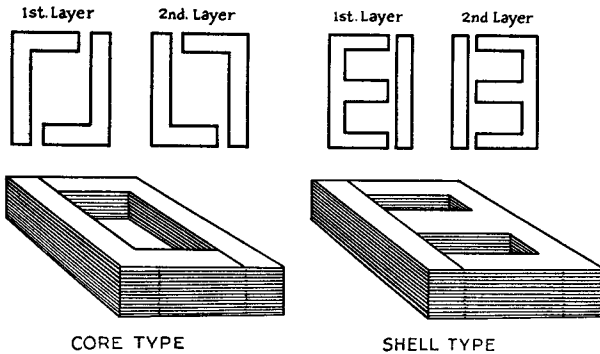

FIG. 1523 — TYPES OF TRANSFORMER CORES, SHOWING THE SHAPES OF LAMINATIONS

inch of cross-sectional area. This relation may be expressed as follows:

$$\text{No. primary turns} = (7.5) \left( \frac{E}{A} \right)$$

where  $E$  is the primary voltage and  $A$  the number of square inches of cross-sectional area of the core. For 110 volt primary transformers the equation becomes:

$$\text{No. primary turns} = \frac{825}{A}$$

The size of wire to use depends on the current the winding will carry at full load. When a small transformer is built to handle a continuous load, the copper wire in the windings should have an area of 1500 circular mils for each ampere to be carried. (See Wire Table in Appendix.) For intermittent use, 1000 circular mils per ampere is permissible.

A table is given showing the best size wire and core cross-section to use for particular transformers. The figures in the table refer to 60-cycle transformers. The design of 25-cycle transformers is similar but a slightly higher flux density is permissible. Because the frequency is much lower the cross-sectional area of the iron must be greater or the number of turns per volt correspondingly larger, otherwise the inductance will be too low to give the required reactance at the reduced frequency. If one builds the core so that its cross-section is 2.1 to 2.2 times the value of area worked out from the table, the same number turns of wire may be used in a primary coil for 25-cycle operation. If the same core and more turns of wire are used a larger "window" will be needed for the extra wire and insulation. Increasing both

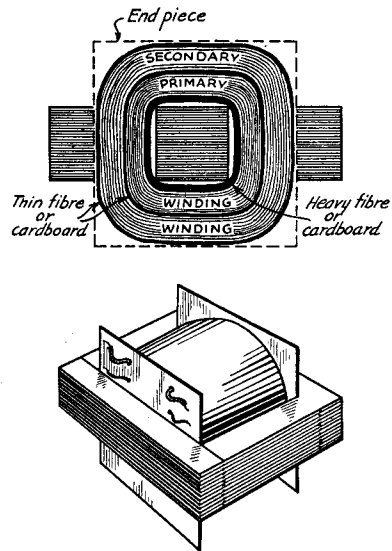

FIG. 1524 — A CONVENIENT METHOD OF ASSEMBLING THE WINDINGS ON A SHELL TYPE CORE

Windings can be similarly mounted on core-type cores, in which case the coils are placed on one of the sides. High-voltage core-type transformers sometimes are made with the primary on one core leg and the secondary on the opposite.

Wire Table in the Appendix shows how many turns of each wire size can be wound into a square inch of window area, assuming that the turns are wound regularly and that no insulation is used between layers. Figures are given for three different types of insulation.



# Power Supply Equipment

DESIGN DATA FOR INDUCTANCE COILS WITH IRON CORES *Weight of Steel taken as 480  $\frac{lb}{cu\ ft.} = 0.28$  pounds*

CORE SIZE	INDUCTANCE HENRYS	EQUIV GAP (G)	*ACTUAL GAP Decimals	GAP Nearest fraction	NO TURNS (N)	FLUX DENS. (B) Lines to inch	WINDINGS FORM		MEAN TURN inches	FEET OF WIRE	RESISTANCE (D.C.)	WEIGHT OF COPPER	CORE DIMENSIONS		POUNDS STEEL	
							b	c					Long Piece	Short Piece		
All wound with No. 33 enameled wire 206.6 ohms per 1000 ft. 6.59 ft. per lb. Carrying Capacity 0.05 amperes.	0.5	.040"	.017"	$\frac{1}{64}$ "	1600	6500	0.42"	0.28"	3.0	4.00	82.5	1.00z	$\frac{1}{2} \times 1.6$	$\frac{1}{2} \times .50$	0.30	
	1.0	.041	.019	$\frac{1}{64}$ "	2300	9000	0.50	0.33	3.2	615	127.0	1.5	$\frac{1}{2} \times 1.7$	$\frac{1}{2} \times .55$	0.31	
	5.0	.043	.023		5200	20000	0.75	0.50	3.8	1670	345.0	4.0	$\frac{1}{2} \times 1.92$	$\frac{1}{2} \times .75$	0.37	
	10.0	.046	.030	$\frac{1}{32}$ "	7600	27000	0.90	0.60	4.2	2640	545.0	6.5	$\frac{1}{2} \times 2.1$	$\frac{1}{2} \times .85$	0.41	
	15.0	.048	.035		9500	32000	1.00	0.68	4.5	3510	725.0	8.5	$\frac{1}{2} \times 2.2$	$\frac{1}{2} \times .85$	0.43	
All wound with No. 30 enameled wire 206.6 ohms per 1000 ft. 3.287 ft. per lb. Carrying Capacity 0.10 amperes.	5.0	.043"	.023		3500	13000	0.62"	0.42"	4.5	1310	271	3.25oz	$\frac{3}{4} \times 2.4$	$\frac{3}{4} \times .75$	1.0	
	10.0	.046	.030		5000	18000	0.73	0.49	4.75	2000	411	5.0	$\frac{3}{4} \times 2.5$	$\frac{3}{4} \times .75$	1.0	
	15.0	.048	.035		6300	21000	0.82	0.55	5.0	2630	544	6.5	$\frac{3}{4} \times 2.6$	$\frac{3}{4} \times .75$	1.05	
	20.0	.052	.044	$\frac{3}{64}$ "	7600	24000	0.91	0.60	5.2	3280	678	8.0	$\frac{3}{4} \times 2.7$	$\frac{3}{4} \times .85$	1.1	
	50.0	.070	.100	$\frac{7}{64}$ "	14000	33000	1.25	0.83	6.0	7000	1445	11.0	$\frac{3}{4} \times 3.0$	$\frac{3}{4} \times 1.0$	1.25	
All wound with No. 26 enameled wire 206.6 ohms per 1000 ft. 1.300 ft. per lb. Carrying Capacity 0.25 amperes.	10.0	.046"	.030	$\frac{1}{32}$ "	3800	14000	0.64"	0.43"	5.6	1760	364	4.25oz	1 x 3.0	1 x .75	2.1	
	15.0	.048	.035		4800	16000	0.69	0.49	5.8	2310	478	5.5	1 x 3.0	1 x .75	2.1	
	20.0	.052	.044	$\frac{3}{64}$ "	5700	18000	0.78	0.52	5.9	2800	580	6.75	1 x 3.1	1 x .75	2.2	
	50.0	.070	.100	$\frac{7}{64}$ "	11000	25000	1.10	0.75	6.7	6130	1270	15.0	1 x 3.5	1 x 1.0	2.5	
	100.0	.100	.250	$\frac{1}{4}$ "	18000	29000	1.40	0.93	7.4	11000	2280	18.10	1 x 3.8	1 x 1.1	2.75	
All wound with No. 23 enameled wire 206.6 ohms per 1000 ft. 6.59 ft. per lb. Carrying Capacity 0.05 amperes.	2 x 2	100.0	.100"	.250	$\frac{1}{4}$ "	8900	14000	0.97"	0.65"	10.4	7700	1590	1 lb 3oz	2 x 5.5	2 x 1.0	14.5
	All wound with No. 30 enameled wire 206.6 ohms per 1000 ft. 3.287 ft. per lb. Carrying Capacity 0.10 amperes.	0.5	.040"	.017	$\frac{1}{64}$ "	1600	13000	0.55"	0.38"	3.4	4.50	46	2.20z	$\frac{1}{2} \times 1.6$	$\frac{1}{2} \times 0.63$	0.31
		1.0	.041	.019	$\frac{1}{64}$ "	2300	18000	0.66	0.45	3.6	700	72	3.5	$\frac{1}{2} \times 1.75$	$\frac{1}{2} \times 0.70$	0.35
		5.0	.043	.023		5200	39000	1.00	0.68	4.5	1950	200	9.5	$\frac{1}{2} \times 2.10$	$\frac{1}{2} \times 0.95$	0.43
		10.0	.046	.030		7600	20000	0.71"	0.49"	5.8	1250	130	6.1oz	1 x 2.8	1 x 0.75	2.0
15.0		.048	.035	$\frac{1}{32}$ "	3800	27000	0.86	0.58	6.1	1940	200	9.5	1 x 3.0	1 x 0.85	2.2	
All wound with No. 26 enameled wire 206.6 ohms per 1000 ft. 1.300 ft. per lb. Carrying Capacity 0.25 amperes.	5.0	.043"	.023		2600	20000	0.71"	0.49"	5.8	1250	130	6.1oz	1 x 2.8	1 x 0.75	2.0	
	10.0	.046	.030	$\frac{1}{32}$ "	3800	27000	0.86	0.58	6.1	1940	200	9.5	1 x 3.0	1 x 0.85	2.2	
	15.0	.048	.035		4800	32000	0.96	0.65	6.4	2550	260	12.5	1 x 3.1	1 x 0.90	2.25	
	10.0	.046"	.030	$\frac{1}{32}$ "	1900	13000	0.60"	0.42"	9.5	1500	160	7.5oz	2 x 4.66	2 x 0.60	11.5	
	15.0	.048	.035		2400	16000	0.68	0.46	9.7	1900	200	9.5	2 x 4.75	2 x 0.66	12.3	
All wound with No. 23 enameled wire 206.6 ohms per 1000 ft. 6.59 ft. per lb. Carrying Capacity 0.05 amperes.	20.0	.052	.044	$\frac{3}{64}$ "	2900	18000	0.75	0.51	9.8	2400	250	11.5	2 x 4.85	2 x 0.75	12.5	
	50.0	.070	.100	$\frac{7}{64}$ "	5300	24000	1.00	0.70	10.5	4600	480	18.65	2 x 5.5	2 x 0.95	14.0	
	100.0	.100	.250	$\frac{1}{4}$ "	8900	28000	1.33	0.90	11.2	8300	860	28.8	2 x 5.90	2 x 1.15	16.0	
	0.5	.040"	.017	$\frac{1}{64}$ "	1600	32000	0.90"	0.60"	4.2	550	22.5	7oz	$\frac{1}{2} \times 2$	$\frac{1}{2} \times .85$	0.40	
	1.0	.041	.019	$\frac{1}{8}$ "	3200	32000	1.30	0.85	5.1	1350	55	11.8	$\frac{1}{2} \times 2.5$	$\frac{1}{2} \times 1.10$	0.50	
All wound with No. 30 enameled wire 206.6 ohms per 1000 ft. 3.287 ft. per lb. Carrying Capacity 0.10 amperes.	0.5	.040"	.017	$\frac{1}{64}$ "	1000	21000	0.72"	0.46"	4.7	390	16	5oz	$\frac{3}{4} \times 2.3$	$\frac{3}{4} \times 0.7$	0.96	
	1.0	.041	.019	$\frac{1}{64}$ "	1500	30000	0.90	0.58	5.1	640	26	8	$\frac{3}{4} \times 2.5$	$\frac{3}{4} \times 0.83$	1.05	
	1.0	.041"	.019		1100	22000	0.75"	0.50"	5.8	530	22	6.5oz	1 x 2.9	1 x 0.75	2.10	
	5.0	.086	.170	$\frac{1}{16}$ "	3700	35000	1.40	0.92	7.3	2260	92	11.8	1 x 3.6	1 x 1.20	2.7	
	5.0	.043"	.023	$\frac{1}{4}$ "	1300	23000	0.82"	0.53"	9.7	1050	43	13oz	2 x 4.9	2 x 0.80	12.7	
All wound with No. 26 enameled wire 206.6 ohms per 1000 ft. 1.300 ft. per lb. Carrying Capacity 0.25 amperes.	10.0	.050	.040	$\frac{1}{64}$ "	2000	32000	1.05	0.68	10.5	1750	71	11.8	6	2 x 5.2	2 x 1.0	13.8
	15.0	.056	.200	$\frac{1}{16}$ "	3300	28000	1.35	0.86	11.1	3060	125	21.6	2 x 6	2 x 5.5	2 x 1.1	14.7
	20.0	.104	.280	$\frac{9}{32}$ "	4000	32000	1.43	0.95	11.5	3820	156	21.15	2 x 6.5	2 x 1.2	15.2	
	10.0	.046"	.030		1300	22000	0.81"	0.53"	14.0	1510	62	11.8	3oz	3 x 6.9	3 x 0.8	3.9
	15.0	.048	.035		1600	26000	0.90	0.60	14.2	1900	77	11.7	3oz	3 x 7.0	3 x 0.85	4.0
All wound with No. 23 enameled wire 206.6 ohms per 1000 ft. 6.59 ft. per lb. Carrying Capacity 0.05 amperes.	20.0	.052	.044	$\frac{3}{64}$ "	1900	30000	1.00	0.65	14.4	2300	93	11.12	3oz	3 x 7.1	3 x 0.9	4.1
	50.0	.140	.330	$\frac{1}{2}$ "	5000	28000	1.60	1.10	15.9	6600	270	51.2	3oz	3 x 7.8	3 x 1.35	4.6
	100.0	.200	.600	$\frac{19}{32}$ "	8400	34000	2.10	1.40	17.0	12000	485	91.3	3oz	3 x 8.3	3 x 1.65	5.0
	0.5	0.16"	.35	$\frac{11}{32}$ "	3200	32000	1.80"	1.20"	6.4	1700	35	21.8oz	$\frac{1}{2} \times 3$	$\frac{1}{2} \times 1.45$	0.62	
	0.5	0.08"	.170	$\frac{11}{64}$ "	1480	30000	1.25"	.83"	6.0	735	15	11.8	2oz	$\frac{3}{4} \times 2.9$	$\frac{3}{4} \times 1.1$	1.26
All wound with No. 30 enameled wire 206.6 ohms per 1000 ft. 3.287 ft. per lb. Carrying Capacity 0.10 amperes.	1.0	0.16	.35	$\frac{11}{32}$ "	3000	30000	1.75	1.20	7.2	1800	37	21.13	$\frac{3}{4} \times 3.5$	$\frac{3}{4} \times 1.5$	1.6	
	0.5	0.04"	.02	$\frac{1}{64}$ "	800	32000	0.90"	0.60"	6.2	410	8.5	0.18	10oz	1 x 3.0	1 x 0.85	2.2
	1.0	0.082	.17	$\frac{11}{64}$ "	1600	31000	1.30	0.85	7.1	945	19	11.8	1oz	1 x 3.5	1 x 1.0	2.5
	5.0	0.387	.75	$\frac{3}{4}$ "	7800	32000	2.90	1.90	11.0	7000	143	10.14	1oz	1 x 5.2	1 x 2.2	4.2
	1.0	0.04"	.019		560	22000	0.75"	0.50"	9.8	460	9.4	0.18	12oz	2 x 4.9	2 x 0.75	12.7
All wound with No. 23 enameled wire 206.6 ohms per 1000 ft. 6.59 ft. per lb. Carrying Capacity 0.05 amperes.	5.0	0.086	.17	$\frac{11}{64}$ "	1800	32000	1.35	0.90	11.3	1700	35	21.10	1oz	2 x 5.5	2 x 1.15	15.0
	10.0	0.184	.40	$\frac{13}{32}$ "	3800	33000	2.00	1.30	12.8	4100	83	6.1	6oz	2 x 6.2	2 x 1.5	17.3
	5.0	0.043"	.023		860	30000	1.00"	0.60"	14.2	1000	21	11.8	10oz	3 x 7.1	3 x 0.85	40.0
	10.0	0.092	.20	$\frac{13}{64}$ "	1840	31500	1.40	0.92	15.3	2350	48	3	10oz	3 x 7.5	3 x 1.15	43.5
	15.0	0.130	.30	$\frac{19}{64}$ "	2620	32000	1.65	1.10	16.0	3500	71	5	7oz	3 x 7.8	3 x 1.4	46.0
All wound with No. 23 enameled wire 206.6 ohms per 1000 ft. 6.59 ft. per lb. Carrying Capacity 0.05 amperes.	20.0	0.175	.38	$\frac{3}{8}$ "	3500	32000	1.90	1.25	16.6	4850	99	7	8oz	3 x 8.1	3 x 1.5	48.0
	50.0	0.432	.80	$\frac{13}{16}$ "	8700	32000	3.00	2.00	19.2	14000	282	21.8	8oz	3 x 9.3	3 x 2.3	58.0
	100.0	0.900	1.50	$\frac{1}{2}$ "	16700	31500	4.10	2.80	22.0	31000	620	41.5	5oz	3 x 10.5	3 x 3.1	68.0

\* The Actual Gap can only be an approximation owing to the many factors which may affect fringing of flux, permeability of core, etc. It must be adjusted by trial until the proper value of inductance is obtained or better yet, until the set up operates at the best point.  
 † The values of (B), the flux density are those obtained with all D.C. & eq. A.C., or the effective B if all A.C. The maximum value in the latter case will be 1.41 x B as given. In the case of rectified A.C. applied to coil with no previous smoothing the maximum B may be 1.57 times the values given.

# The Radio Amateur's Handbook . . . . .

The primary winding of the 200-watt transformer, which has 270 turns of No. 17 wire, would occupy 270/329 or .82 square inches if wound with double-cotton-covered wire, for example. This makes no allowance for a layer of insulation between the windings (in general, it is good practice to wind a strip of paper between each layer) so that the winding area allowance should be increased if layer insulation is to be used. The figures also are based on accurate winding such as is done by machines; with hand winding it is probable that somewhat more area would be required. An increase of 50% should take care of both hand winding and layer thickness. The area to be taken by the secondary winding should be estimated, as should also the area likely to be occupied by the insulation between the core and windings and between the primary and secondary windings themselves. When the total window area required has been figured — allowing a little extra for contingencies — laminations hav-

not be square but can be rectangular in shape so long as the core area is great enough. It is easier to wind coils for a core of square cross-section, however.

Transformer cores are of two types, "core" and "shell." In the core type, the core is simply a hollow rectangle formed from two "L"-shaped laminations, as shown in Fig. 1523. Shell-type laminations are "E" and "I" shaped, the transformer windings being placed on the center leg. Since the magnetic path divides between the outer legs of the "E," these legs are each half the width of the center leg. The cross-sectional area of a shell-type core is the cross-sectional area of the center leg. The shell-type core makes a better transformer than the core type, because it tends to prevent leakage of the magnetic flux. The windings are calculated in exactly the same way for both types.

Fig. 1524 shows the method of putting the windings on a shell-type core. The primary is usually wound on the inside — next to the core — on a form made of fibre or several layers of cardboard. This form should be slightly larger than the core leg on which it is to fit so that it will be an easy matter to slip in the laminations after the coils are completed and ready for mounting. The terminals are brought out to the side. After the primary is finished, the secondary is wound over it, several layers of insulating material being put between. If the transformer is for high voltages, the high-voltage winding should be carefully insulated from the primary and core by a few layers of Empire cloth or tape. A protective covering of heavy cardboard or thin fibre should be put over the outside of the secondary to protect it from damage and to prevent the core from rubbing through the insulation. Square-shaped end pieces of fibre or cardboard usually are provided to protect the sides of the winding and to hold the terminal leads in place. High-voltage terminal leads should be enclosed in Empire cloth tubing or spaghetti.

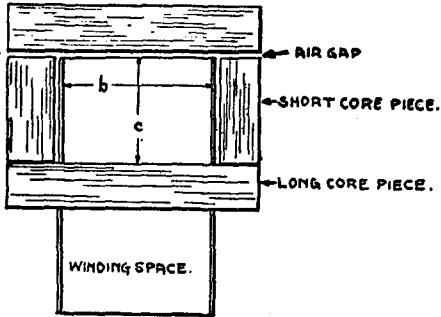

FIG. 1525 — CORE ARRANGEMENT FOR FILTER CHOKE COILS

The dimensions *b* and *c* refer to the full-page table

ing the desired leg width and window area should be purchased. It may not be possible to get laminations having exactly the dimensions wanted, in which case the nearest size should be chosen. The cross-section of the core need

Input (Watts)	Full-load Efficiency	Size of Primary Wire	No. of Primary Turns	Turns Per Volt	Cross-Section Through Core
50	75%	23	528	4.80	1 1/4" x 1 1/4"
75	85%	21	437	3.95	1 3/8" x 1 3/8"
100	90%	20	367	3.33	1 1/2" x 1 1/2"
150	90%	18	313	2.84	1 5/8" x 1 5/8"
200	90%	17	270	2.45	1 3/4" x 1 3/4"
250	90%	16	248	2.25	1 7/8" x 1 7/8"
300	90%	15	248	2.25	1 7/8" x 1 7/8"
400	90%	14	206	1.87	2 " x 2 "
500	95%	13	183	1.66	2 1/8" x 2 1/8"
750	95%	11	146	1.33	2 3/8" x 2 3/8"
1000	95%	10	132	1.20	2 1/2" x 2 1/2"
1500	95%	9	109	.99	2 3/4" x 2 3/4"

After the windings are finished the core should be inserted, one lamination at a time. Fig. 1523 shows the method of building up the core. In the first layer the "E"-shaped laminations are pushed through from one side; the second "E"-shaped lamination is pushed through from the other. The "I"-shaped laminations are used to fill the end spaces. This method of building up the core ensures a good magnetic path of low reluctance. All laminations should be insulated from each other to prevent eddy currents from flowing. If there is iron rust or a scale on the core material, that will serve the purpose very well — otherwise one side of each piece can be coated with thin shellac. It is essential that the joints in the core be well made and be square and even. After the transformer is assembled, the joints can be hammered up tight using a block of wood between the hammer and the core to prevent damaging the laminations. If the winding form does not fit tightly on the core, small wooden wedges may be driven between it and the core to prevent vibration. Transformers built by the amateur can be painted with insulating varnish or waxed to make them rigid and moisture proof. A mixture of melted beeswax and rosin makes a good impregnating mixture. Melted paraffin should not be used because it has too low a melting point. Double-cotton-covered wire can be coated with shellac as each layer is put on. However, enameled wire should never be treated with shellac as it may dissolve the enamel and hurt the insulation, and it will not dry because the moisture in the shellac will not be absorbed by the insulation. Small transformers can be treated with battery-compound after they are wound and assembled. Strips of thin paper between layers of small enameled wire are necessary to keep each layer even and to give added insulation. Thick paper must be avoided as it keeps in the heat generated in the winding so that the temperature may become dangerously high.

Keep watch for shorted turns and layers. If just one turn should become shorted in the entire winding, the voltage set up in it would cause a heavy current to flow which would burn it up, making the whole transformer useless.

Taps can be taken off as the windings are

made if it is desired to have a transformer giving several voltages. The more taps there are, the more difficult becomes the problem of avoiding weakened insulation at the points where they are made. Taps should be arranged whenever possible so that they come at the ends of the layers. If the wire of which the winding is made is very small, the ends of the winding and any taps that are made should be of heavier wire to provide stronger leads.

After leaving the primary winding connected to the line for several hours it should be only slightly warm. If it draws much current or gets hot there is something wrong. Some short-circuited turns are probably responsible and will continue to cause overheating and possibly fireworks later.

#### **Building Filter Choke Coils**

● Filter choke coils resemble transformers in construction, but only one winding is used. The core may be either of the core or shell type, but the corners should not be interleaved, a butt joint being used instead. This is done so that the core can be opened slightly to form an air gap in the magnetic path. An air gap actually increases the effective inductance of the choke when direct current is flowing through the winding by preventing magnetic saturation of the core. Since a low-reluctance magnetic path is not necessary, the shell-type of core has no particular advantages. The full-page table of choke coil specifications is based on the core-type construction illustrated in Fig. 1525. The core may be built of straight pieces, as shown, or from L-shaped laminations of the type shown in Fig. 1523.

The table gives specifications for chokes that will meet most needs of the amateur in filter systems. Chokes of inductances between the values given in the table can be made by using less turns of wire in the winding. Inductance varies about as the square of the number of turns so that using half the number of turns specified gives one-fourth the inductance. More turns than those specified must not be used as the core will become saturated. Dimensions *b* and *c* given in the table can be understood by reference to Fig. 1525. The arrangement of core and winding should be that of the diagram, also.

# 16

## Antennas

### TYPES OF ANTENNAS — FEEDER SYSTEMS — METHODS OF COUPLING—IMPEDANCE MATCHING —DIRECTIVE ARRAYS—ANTENNAS FOR THE ULTRA-HIGH FREQUENCIES

**T**HE antenna systems used by amateurs are of two types, called "Marconi" and "Hertz" antennas after the men who first applied them to radio communication. The Marconi antenna, which may be a single wire, vertical or part vertical and part horizontal, is connected to the ground through coupling and tuning apparatus; in its performance the ground plays an essential part. The Hertz antenna is a single wire suspended above the earth; the earth plays no part in the mechanism of radiation from the Hertz antenna, although it has a profound effect on its practical performance. For short-wave work the Hertz antenna is used almost exclusively; however, at the lower amateur frequencies, particularly in the 1715-2000-kc. band, space limitations sometimes preclude its use by amateurs and the grounded antenna must be substituted.

The fundamental principles on which antennas operate have already been discussed in Chapter Four. A complete understanding of these principles is, of course, of great value to the amateur interested in planning his own antenna system and in getting the best possible performance from it.

Contrary to usual practice throughout this *Handbook*, in this chapter we shall find it more convenient to speak in terms of wavelength than in terms of frequency. At the same time, however, the relationship between frequency and wavelength should be kept in mind continually.

#### General Considerations of Antenna Coupling

● Transmitter output circuits fall into but two classes as far as coupling to any type of antenna system is concerned. The output circuit is either balanced or unbalanced depending upon whether the r.f. ground or connection to filament is at one end of the output tank circuit or at the center of the tank circuit or oc-

asionally at some other intermediate point. The common types coming under the class of unbalanced circuits (see Fig. 1601) are output triode frequency doublers with no neutralization, tetrode or pentode output amplifiers requiring no neutralization and the output circuits of single or parallel connected triodes with grid circuit neutralization. (See Chapter Eight.)

The output circuits of plate neutralized amplifiers and push-pull amplifiers come under the balanced class. If certain coupling considerations make it necessary to provide a balanced output circuit, the unbalanced output circuit may always be converted to the balanced class by placing the r.f. ground at the center of the circuit as indicated in *H* and *I* Fig. 1601. In all of the following diagrams referring to antenna coupling methods, only one type in each class will be shown. The method of coupling under discussion, however, will be equally applicable to all types coming under the general classification designated.

#### The Grounded Antenna

● The important points about the grounded antenna are three: its length, height and the ground connection. To be most effective, the antenna should be as high as possible and the ground connection should have low r.f. resistance.

The ground should preferably be one with conductors buried deep enough to reach natural moisture. In urban locations, good grounds can be made to water mains where they enter the house; the pipe should be scraped clean and a low-resistance connection made with a tightly-fastened ground clamp. If no water-pipes are available several pipes, six to eight feet long, may be driven into the ground at intervals of six or eight feet, all being connected together. The transmitter should be located so as to make the ground lead as short as possible.

In locations where it is impossible to secure a good ground connection because of sandy soil or other considerations, it is preferable to substitute a counterpoise for the ground connection. The counterpoise consists of a system of wires insulated from ground running horizontally above the earth beneath the antenna. The counterpoise should have a sufficient number of wires of sufficient length to cover well the area immediately under the antenna. The wires may be formed into any convenient shape, i.e., they may be spread out fan-shape, in a radial pattern, or three or more parallel wires separated a foot or so running beneath the antenna may be used. The counterpoise should be elevated six or seven feet above the ground so as not to interfere with persons walking under it. Connection is made between the usual ground terminal of the transmitter and each of the wires in the counterpoise.

The natural wavelength of a bent grounded antenna is approximately 4.2 times its actual length. It is not necessary to make a highly-accurate calculation when figuring the length of a grounded antenna because the tuning apparatus inserted at the base will compensate for discrepancies between the natural wavelength and the transmitter wavelength or frequency. For example, an antenna for 1900 kc. (158 meters wavelength) should be  $158 / 4.2$  or 37.6 meters long, corresponding to a length of 124 feet. This length, it should be noted, is the *total* length from the far end of the antenna to the ground connection, or lengths *A* plus *G*, Fig. 1602.

An appreciable portion of the length of the Marconi type antenna must necessarily run through an area close to ground and other energy-absorbing objects so that the use of this type is not recommended except in case sufficient space is not available for the necessary length for a Hertz type antenna.

### Coupling to the Marconi Antenna

● Fig. 1602 shows several methods of coupling the transmitter to the Marconi antenna. The method shown at *A* and *C* is simple and effective. A coil and condenser are inserted in series

at the base of the antenna. The size of the coupling coil will affect both the degree of coupling and the resonant frequency of the antenna. Increasing the number of turns as well as moving the coupling coil closer to the tank coil will increase coupling. Increasing the number of turns will, at the same time, increase the natural wavelength of the antenna or decrease its resonant frequency. This latter effect may be compensated for by changing the capacity of the antenna series condenser, a decrease in the capacity of which will increase the resonant frequency. The number of turns should be adjusted to provide the necessary coupling for satisfactory loading and at the same time provide the correct amount of inductance to permit tuning the system to resonance with the series condenser. Any con-

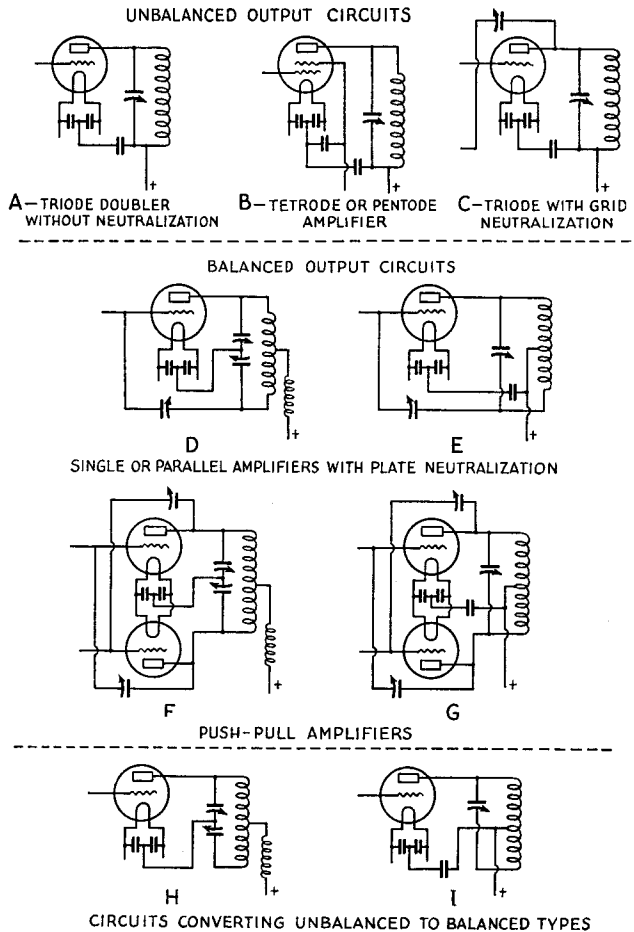

FIG. 1601 — CLASSIFICATION OF OUTPUT CIRCUITS IN REFERENCE TO ANTENNA COUPLING

# The Radio Amateur's Handbook . . . . .

flict between the two functions may usually be taken care of by changing the distance between the coupling coil and the tank coil for changing coupling and by adjustment of the con-

ducts coupled to the antenna by means of a pi-section filter. While the use of this method of coupling involves some additional apparatus, it has some advantages over the simple inductive coupling system. Its uses and construction will be discussed in detail later.

## UNBALANCED

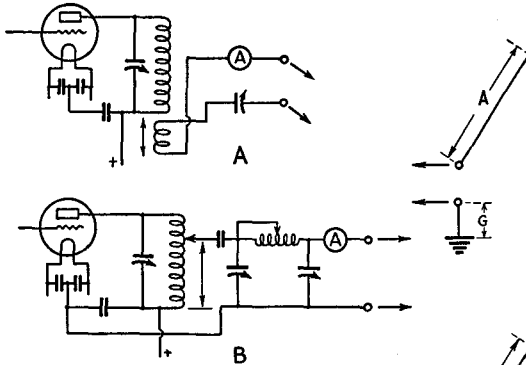

## BALANCED

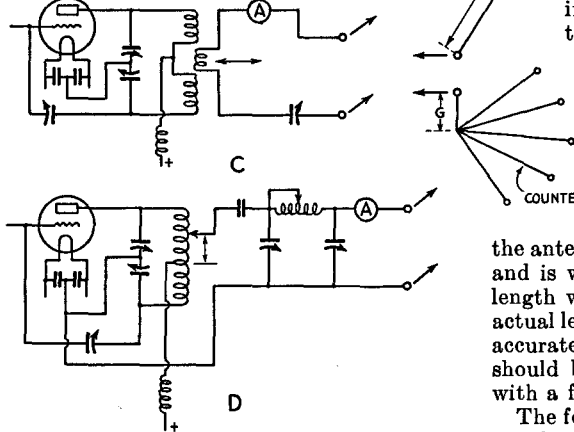

FIG. 1602 — THE MARCONI ANTENNA WITH VARIOUS METHODS OF COUPLING

denser for restoring resonance. A series capacity of 250  $\mu\mu\text{fds}$ . is usually sufficient.

Coupling the antenna to the transmitter will usually affect the tuning of the final amplifier plate circuit. With each change in antenna coupling or tuning, the tuning of the final tank circuit should be checked to make sure that it is tuned to resonance, indicated by the usual dip in plate current. The dip will not be as pronounced as it was before coupling to the antenna but nevertheless should be noticeable. If the coupling is made too tight, there may be an indication of resonance at two points. The obvious remedy is to reduce coupling.

The diagrams at B and D show output cir-

## Hertz Antennas

● The natural wavelength of a Hertz antenna depends primarily upon its length and secondarily upon such factors as may operate to change the distributed constants of the wire from those it would have in space. The natural wavelength is approximately twice the length of the wire, as explained in Chapter Four. In practice the natural wavelength of the wire will be somewhat greater than twice the physical length, partly because electromagnetic waves do not travel quite as fast on wires as they do in space, and partly because the antenna is in proximity to other objects, including the antenna poles, guy wires and insulators, all of which increase the distributed capacity and thereby increase the wavelength of the antenna. Because of the varying nature of these extraneous effects, the natural period of a given length of wire will differ with different surroundings.

If the antenna is reasonably clear of other objects and is well off the ground, its natural wavelength will be between 2.07 and 2.1 times its actual length. If it is desired to determine more accurately the resonant frequency, the antenna should be coupled to a driver and measured with a frequency meter.

The following formula can be used for figuring the correct length for a half-wave antenna to a close approximation:

$$\text{Length (feet)} = 1.56 \times \text{wavelength in meters.}$$

$$\text{Length (meters)} = 0.475 \times \text{wavelength in meters.}$$

$$\text{Length (feet)} = \frac{468,000}{\text{Freq. (kc.)}} = \frac{468}{\text{Freq. (mc.)}}$$

$$\text{Length (meters)} = \frac{142,500}{\text{Freq. (kc.)}} = \frac{142.5}{\text{Freq. (mc.)}}$$

The lengths given by the formulas are for half-wave antennas — the minimum length that can be used for the frequency or wavelength in question. As explained in Chapter Four, the wire may be any integral multiple of a half wave in length, so long as a whole number of complete standing waves can appear on it. Thus an antenna having a length double that given by the formulas will have two half

waves on it; it is known as a full-wave or second harmonic antenna. The fact that the antenna may be any number of half waves long makes it possible to use the same antenna for work in several bands, since a full-wave (second-harmonic) antenna for one band will be a half-wave (fundamental) antenna on the next lower-frequency band, two full waves long (fourth harmonic) on the next higher-frequency band, and so on.

### Radiation Resistance and Antenna Impedance

● As explained in Chapter Four, an important antenna property is its radiation resistance. This varies with the length of the antenna, its position with respect to surrounding objects, character of the ground and other local conditions. In space, the radiation resistance of a half-wave Hertz antenna is approximately 70 ohms, measured at the center of the antenna. Curve A in Fig. 1603 shows how the radiation resistance varies with the length of the antenna. Because of the higher radiation resistance, the proportion of power radiated to power supplied the antenna is increased as the length of the antenna is increased. Curve B shows the relative power in the major radiation lobe, using a half-wave antenna as the basis of comparison. The power in the major lobe of a four-wave antenna, for instance, will be twice as great as in the major lobe of a half-wave antenna, assuming the same antenna current in both cases. Since the antenna current will decrease as the radiation resistance increases, however, the actual power ratio will not be as favorable, assuming the same power input to the antenna. Some gain actually results from the use of a long antenna, however.

The impedance of an antenna varies with the point along the antenna at which it is measured. It is minimum and practically equal to the radiation resistance at a current loop or antinode, and is maximum at a voltage loop, with intermediate values at intermediate points. The impedance of a half-wave antenna varies from approximately 70 ohms at the center to something in the vicinity of 2000 ohms at the ends.

### Directly Excited Hertz Antennas

● Before the antenna can do any radiating, it must be supplied with power from the transmitter. This process is called "feeding" or "exciting" the antenna. Antennas may be directly excited or fed through a non-radiating transmission line, the transmitter being placed in any convenient location in the latter case.

General practice is to feed an antenna of the

directly excited type either at one end or at its center. The antenna may be either "current" or "voltage" fed. These labels simply mean that the power is introduced into the antenna either at a point of maximum current — a current loop — or a point of maximum voltage — a voltage loop or current node.

Fig. 1604 shows a common form of directly excited Hertz antenna fed at the center. When operated at its fundamental frequency each section should be one-quarter wavelength long or the total length ( $A$  plus  $B$ ) should be one-half wavelength long as computed by the preceding formula. The two quarter-wave sections should run with an angle of separation as great as possible and at the same time should be as well elevated as possible. These two desirable conditions conflict, of course, which is the greatest disadvantage of the directly excited antenna. The other disadvantage is that a portion of the antenna itself must be brought into the station where energy is absorbed and the radiation pattern distorted often in an undesirable manner. This type of antenna may be coupled in the same manner described for the Marconi antenna except that in the case of  $D$ , Fig. 1604, where a balanced output circuit is

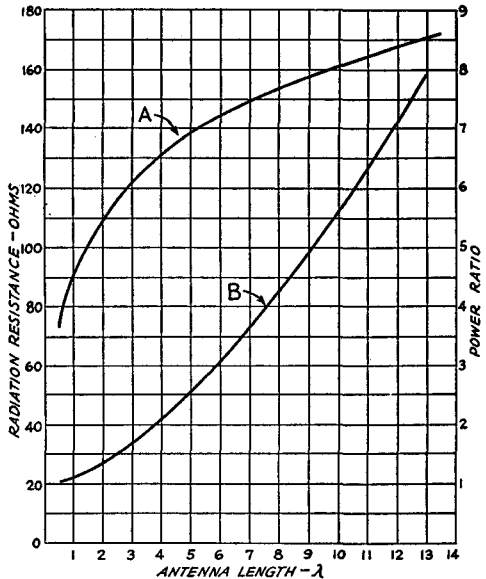

FIG. 1603 — THE IMPORTANT CURVES FOR HARMONICALLY-OPERATED HORIZONTAL ANTENNAS

Curve A shows the variation in radiation resistance with antenna length. Curve B shows the power in the lobes of maximum radiation for long-wire antennas as a ratio to the maximum of a half-wave doublet antenna.

used with the pi-section filter, the inductance is split into two sections as will be explained later. When operating at the fundamental frequency of the antenna, the antenna tuning condenser will be connected in series with the coupling coil. Frequently, to maintain a complete balance throughout, two tuning condensers, one each side of the coupling coil, are used although the additional one is not strictly necessary.

When operating this antenna at any of its even harmonics (2nd, 4th, etc.), voltage distribution will be such that maximum voltage will be developed at the terminals of the coupling coil. This calls for parallel tuning as indicated by the dotted lines in *A* and *C*, Fig. 1604. In this case, the circuit consisting of the coupling coil and condenser must tune to

resonance, preferably with a low value of capacity. This will usually require separate coupling coils for each frequency band of operation if maximum results are to be obtained. Frequently, however, a compromise is made by adjusting the size of a single coil so that it will suffice for operation on all bands.

Adjustments in general are the same as for series tuning. The coupling is first made loose and the antenna condenser tuned for an increase in plate current. When resonance has been attained, coupling may be increased for proper loading. Variations in coupling and tuning of the antenna may affect tuning of the plate tank circuit as mentioned previously. Tuning condensers of 250  $\mu\text{fd}$ s. each should be satisfactory.

### Directly Excited End-Fed Antenna

● A directly excited antenna of the end-fed type is shown in Fig. 1605. This antenna is voltage-fed at the fundamental as well as at its harmonics. The antenna length, which should be measured from the remote end to the point at which it is attached to the antenna tank circuit, should be one-half wavelength long for the lowest frequency at which operation is desired as determined by the formula. With the approximate dimensions given in Fig. 1605 the antenna will operate at 3.5 mc. and all of its harmonics. If a ground connection is used, this antenna may also be used at half the fundamental frequency, in this case 1.75 mc.

Antenna length with this type of feed is somewhat more critical than with center or current feed. The antenna tank circuit should tune to resonance at the operating frequency with a low value of capacity. Antenna tank circuit coils must be changed, of course, each time operation is changed from one band to another.

The tuning procedure should be as follows: With the antenna disconnected from the circuit *LC*, start the transmitter and tune *LC* to resonance as indicated by a sharp increase in the transmitting-tube plate current. Now loosen the coupling until the plate current gives only a small kick as *LC* is tuned through resonance. Next, connect the antenna and retune *LC* for the plate-current kick; the resonance indication will be broader with the antenna connected, but should still come at the same setting of *C* if the antenna length is correct. If it does not do so, the antenna length should be adjusted until it does. Increase the coupling in small steps, simultaneously readjusting *C*

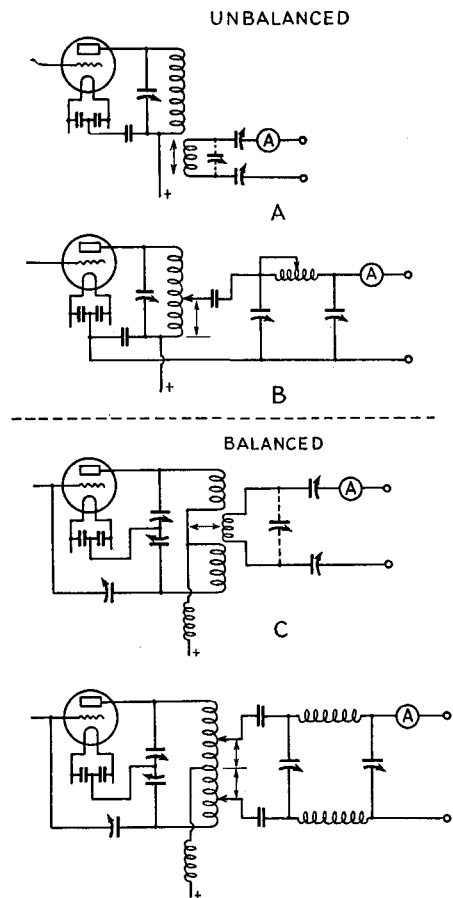

FIG. 1604—DIRECTLY EXCITED ANTENNA—CENTER-FED WITH SUITABLE COUPLING ARRANGEMENTS



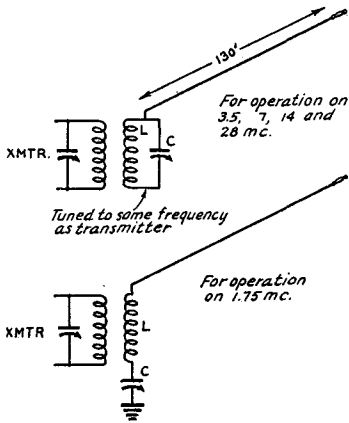

FIG. 1605 — A SIMPLE ANTENNA SYSTEM FOR FIVE AMATEUR BANDS

The antenna is voltage fed on 3.5, 7, 14 and 28 mc., working on the fundamental, second, fourth and eighth harmonics, respectively. For 1.75 mc. the system is a quarter-wave grounded antenna, in which case series tuning must be used. The antenna wire should be kept well in the clear and should be as high as possible.

If the length of the antenna is approximately 260 feet, voltage feed can be used on all five bands.

ing adjusted for maximum current. The ground lead with this antenna system should preferably be short, otherwise it will make the antenna length a great deal more than a quarter wave and necessitate a change in the tuning system.

The various methods by which an antenna of this type may be coupled to the transmitter are shown in Fig. 1606. At C and F, a low impedance link line (discussed in Chapter Eight in reference to interstage coupling) is used between the output tank circuit and the antenna tank circuit. Adjustment is much the same as with simple inductive coupling except that the number of turns at each end of the link line is varied to give the proper coupling instead of moving the antenna tank coil closer to or farther away from the output tank circuit. A relatively few turns will be required at each end of the link even for the lowest frequencies. It should not be difficult to determine the optimum number of turns by experiment. The use of the link line reduces the effect of capacity coupling, thereby reducing harmonic output. Since the end-fed antenna responds easily to all harmonics, steps to eliminate the harmonic in the antenna may be found necessary. Additional information will be found on succeeding pages.

and the transmitter tank condenser to resonance each time the coupling is changed, until the transmitter is drawing normal plate current. Always use the loosest coupling that will give normal transmitter plate current with both the transmitter tank and coupling tank adjusted to resonance. A neon bulb touched to the end of the antenna will give, by the brightness of its glow, some indication of the r.f. voltage at the coupling point.

In using the antenna arrangement of Fig. 1605 as a grounded antenna, tuning is simply a question of adjusting the size of L and the setting of C to give resonance with the transmitter frequency as described previously for the Marconi antenna. An ammeter may be inserted in the antenna at the point where it is connected to the tun-

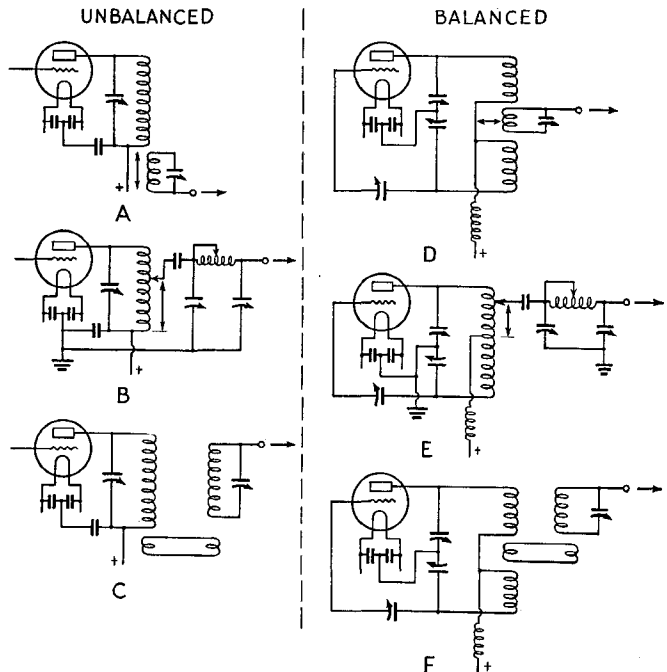

FIG. 1606 — SEVERAL SUGGESTIONS FOR COUPLING THE END OF VOLTAGE-FED ANTENNA

The pi-section network mentioned previously is used at *B* and *E*. The end-fed antenna has some advantages over the center-fed arrangement since it is usually possible to arrange it so that an appreciable portion of the antenna is in clear space and fairly well elevated. However, the portion of the antenna which is brought in to the transmitter is at high r.f. potential, which is undesirable.

### Transmission Line Feed

● The chief disadvantages of the antenna types discussed thus far are the facts that to couple the transmitter to these antennas an appreciable portion of the radiating antenna itself must be placed in unfavorable areas and that the antennas frequently must be bent into undesirable shapes to reach the transmitter. Where space is available these disadvantages may be overcome by locating the antenna in the most favorable space available and feeding the antenna by means of a transmission line.

Radio-frequency transmission lines are of two general types, those on which standing waves similar to the standing waves on the antenna appear (tuned or resonant lines) and those having uniform current distribution along the line (untuned, non-resonant or aperiodic lines).

The impedance of the untuned transmission line must be matched to that of the antenna at the point of connection. Since this can be done accurately for only one frequency, an antenna system incorporating an untuned line is essentially a single-frequency (or perhaps single-band) affair, although with certain systems multi-band operation is possible with some sacrifice of efficiency. The tuned transmission line, on the other hand, is readily adaptable to multi-band operation. With the lengths of line used by most amateurs there is little to choose between the two types from the standpoint of line losses. When the length of the transmission line is more than a wavelength or two long, the untuned line may have somewhat lower losses when correctly adjusted. However, correct adjustment of this type of line is often difficult to check with accuracy so that, unless extreme care is taken, losses may run as high or higher with the untuned line than with the tuned line. Tuned lines are somewhat simpler to build and adjust than untuned lines.

### Tuned Transmission Lines

● A resonant transmission line is simply an antenna that has been folded so that the currents flowing in the two parts are opposite in phase but of the same magnitude, as explained

in Chapter Four. The radiation from one wire therefore cancels that from the other.

Although tuned transmission lines may be of almost any length, there are two important practical cases. The first is that of a line one or any odd number of quarter waves in length. The line length is considered to be that of one wire only; that is, a folded half-wave wire is a quarter-wave line, etc. Such a line possesses the property of transforming the impedance of the part of the antenna to which it is connected from a high to a low value and vice versa. In other words, if the output end of the line is connected to a voltage-feed point on the antenna, current feed will be required to the line itself at its input end. If the line is connected to a current-feed point, voltage feed will be required to the line at the input end.

The other type of tuned line is that having a length equal to some even number of quarter waves. With such a line the impedance looking into the line at the input end will be the same as the impedance connected to the output end. Therefore if a half-wave line is connected to a voltage-feed point on the antenna, voltage feed will be required at the input end of the line, etc.

The two wires of the tuned transmission line should both be exactly the same length. They are usually spaced from three to twelve inches apart. The spacing is not critical at most frequencies; since even a foot separation represents but a very small fraction of a wavelength the cancellation is practically complete. It is preferable to make the length of the line an exact multiple of a quarter wavelength, although this is not strictly necessary because the tuning apparatus can serve the double purpose of coupling in the power from the transmitter and of loading the feeders to compensate electrically for differences between a quarter wavelength and the actual length of the wires.

### The Zepp

● Probably the most popular type of Hertz antenna with tuned feeders is the Zeppelin or "Zepp" antenna, so-called because of its early use on Zeppelin airships. The Zepp is a Hertz antenna with one wire of the tuned feed line connected to one end of the antenna. The other feed wire is left floating. The antenna is therefore voltage-fed from the transmission line.

The antenna may be any number of half waves long, the length of a half wave being computed by the formula previously given. The feeder is usually an odd multiple of a quarter wavelength long for the fundamental

frequency and an even multiple of a quarter wavelength for the harmonics. Frequently, however, certain intermediate lengths which will permit series tuning on more than one band are satisfactory. These lengths are given under Fig. 1608.

In general, series tuning can be used with

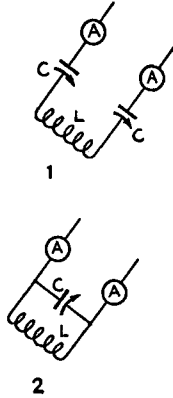

**FIG. 1607—SERIES AND PARALLEL FEEDER TUNING**

*Series tuning is used when there is a current loop on the feeders at the coupling point; parallel tuning when a voltage loop appears at the coupling point. The feeders are operating properly when the currents indicated by the two ammeters are identical.*

feeders having a length between one-quarter and three-eighths of a wavelength; for feeders much less than a quarter wave long, or for lengths from approximately three-eighths up to one-half wavelength, parallel tuning will be required. However, certain lengths will be encountered occasionally with which it will be difficult to obtain resonance and satisfactory coupling with either system of tuning.

Fig. 1607 shows larger-scale diagrams of series and parallel feeder tuning, and also shows how r.f. ammeters may be connected in the feeders to indicate resonance. The use of two ammeters is not actually necessary; a single ammeter may be switched from one feeder to the other during the tuning process. Both ammeters should give the same readings; if the readings differ by more than 10% or so when the antenna system is tuned exactly to resonance with the transmitter, the system is not properly balanced. Care should be taken to see that both feeders are the same length and that the leads inside the station from the coupling apparatus to the feeders are symmetrical. The length of the antenna itself also must be correct if the feeder currents are to be balanced.

In the series-tuning arrangement shown in Figs. 1607, 1608, 1609 and 1610 it is not necessary to have two tuning condensers, but they are often used because with two condensers it is possible to shift the voltage node to a desirable point on the coupling coil, *L*, and to compensate for the effect of stray capacities

at the tuning apparatus. The current distribution in the feeders at resonance will be the same with either one or two condensers provided distributed and stray capacities in the tuning apparatus are negligible.

The numerical value of the feeder current indicated by the antenna ammeter or ammeters is not the true indication of how well the system is operating. If the meters happen to be connected at or near current nodes (voltage loops) they will indicate very little current. This is particularly likely to happen when parallel tuning is used and the feeders are nearly multiples of  $\frac{1}{2}$ -wave long for the frequency being used.

A Zepp antenna system suitable for opera-

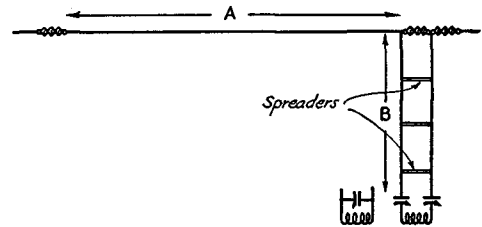

**FIG. 1608 — THE ZEPPELIN ANTENNA**

*The antenna length, *A*, is given by the formula earlier in the chapter. It should be cut for a half wavelength on the lowest frequency to be used. Feeder lengths, *B*, and tuning arrangements can be taken from the table below.*

Approximate Length of Each Wire, Feet	Tuning Arrangement for Various Bands				
	1750 kc. (160 m.)	3500 kc. (80 m.)	7000 kc. (40 m.)	14000 kc. (20 m.)	28000 kc. (10 m.)
120	Ser.	Par.	Par.	Par.	Ser. or Par.
90	Par.	Ser.	Ser.	Par.	Ser. or Par.
60	Par.	Ser.	Par.	Par.	Ser. or Par.
40	(--)	Par.	Ser.	Par.	Par.
30	(--)	(--)	Ser.	Par.	Ser. or Par.
15	(--)	(--)	Par.	Ser.	Par.
8	(--)	(--)	(--)	Par.	Ser.

Ser.—Series Tuning. Par.—Parallel Tuning. (--)—Not Recommended.

tion in several amateur bands is shown in Fig. 1608.

### Center-Fed Antennas

● An antenna also may be fed at the center through a tuned transmission line. When a half-wave antenna is fed at the center there

# The Radio Amateur's Handbook . . . . .

must be a current loop at the end of the transmission line; the antenna is cut in the center, and each half is connected to one of the feeder wires. The center-fed arrangement may be preferred when it is more convenient to feed the antenna at the center than at one end. It should be noted, however, that when the

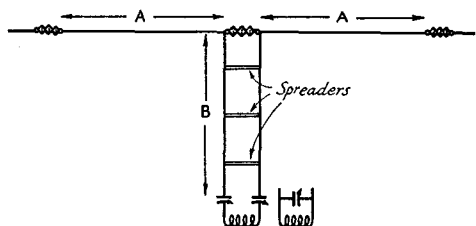

FIG. 1609 — CENTER-FED ANTENNA WITH TUNED FEEDERS

The total antenna length,  $A$  plus  $A$ , is calculated from the formula given early in this chapter. The antenna should be cut to be a half-wave long on the lowest frequency to be used.

Feeder lengths may be identical with those recommended for the Zepp antenna in Fig. 1608. If the antenna is a half-wave long at the operating frequency, the tuning arrangements should be reversed (parallel tuning where series is specified, etc.). If the antenna is operated on a harmonic, use the tuning specifications exactly as given in Fig. 1608.

center-fed antenna is greater than one-half wavelength long, that is, when it is being operated at a harmonic, the radiation pattern will differ from that of an end-fed or Zepp type of the same dimensions. Radiation patterns will be discussed later.

An antenna fed at the center by a tuned transmission line may be either current- or voltage-fed. If the antenna is a half wave in length, it will be current-fed; however, voltage-feed will be necessary if the length is a multiple of a half wave. A center-fed antenna with tuned feeders is shown in Fig. 1609.

## Tuning

● The tuning of Zepp and center-fed systems is quite similar. When series tuning is used with either of the typical antenna systems shown in Figs. 1607 and 1609, the series condensers should be set at maximum capacity; with parallel tuning, at minimum. After the transmitter has been set on the desired frequency the antenna coupling coil should be coupled to the transmitter tank and the series condensers tuned simultaneously, from maximum capacity down, until the radio-frequency ammeter shows maximum feeder current and the plate milliammeter shows normal plate current. If the meters should show two points of maximum current, the coupling should be

loosened. After tuning for maximum current the capacity of the feeder series condensers should be increased until the current drops about 15%, if the transmitter is a self-excited rig. With an oscillator-amplifier set the best tuning adjustment is the one which gives maximum balanced feeder current. The procedure with parallel feeder tuning is similar except that the parallel condenser is tuned from minimum capacity upwards instead of from maximum capacity down. If the feeder current should be very low in value with parallel tuning, the plate input as shown by the plate milliammeter will be a better indication of resonance. Plate current should be the greatest when the feeder circuit is tuned to resonance.

Tuned transmission lines are particularly advantageous for amateur work because all the adjustments can be made inside the station. The dimensions of the antenna system also are less critical than when the antenna is fed by an untuned line. Should the length of the antenna be slightly incorrect for the operating frequency the only result will be a corresponding lack of balance in the feeder currents. While this may cause the feeders to radiate a small portion of the energy supplied to them, nevertheless the whole system can still be tuned to resonance and will operate at good efficiency.

## Choice of Coupling Methods

● Fig. 1610 shows additional ways in which either Zepp or center-feed feeders may be coupled to the output circuit. Preferred methods for the Zepp are shown at  $A$ ,  $B$ ,  $D$ , and  $E$ . If the pi-section filters shown at  $C$  and  $F$  are used, the feeders may be of any convenient length. However, because the Zepp is an inherently unbalanced system, instability of the output circuit is sometimes experienced when an attempt is made to use the pi-section filter for this purpose.

The center-fed system should work well with any of the methods shown with the possible exception of method  $C$  where it is coupled to an unbalanced output circuit. In this case, it would probably be preferable to use method  $A$  or  $B$ .

## Untuned Transmission Lines

● The tuned transmission lines just described operate with standing waves on them and therefore their length is an important consideration. The untuned transmission line, on the other hand, operates without standing waves and can be made any random length, provided it is properly coupled to the antenna.

Any transmission line has distributed inductance and capacity, just as has the antenna.

The inductance and capacity per unit length determine the characteristic or surge impedance of the line; inductance and capacity in turn depend upon the size of the wire used and the spacing between the wires, if the line consists of two parallel wires. The surge impedance will be

$$Z = 276 \log \frac{b}{a}$$

where  $Z$  is the surge impedance,  $b$  is the wire spacing, and  $a$  is the radius of the wire.

It is a characteristic of a transmission line that if it is terminated in an impedance equal to its surge impedance, reflection cannot occur and standing waves will not be present. It is the object, therefore, in adjusting the untuned transmission line to terminate it at the antenna in an impedance equal to its surge impedance.

When this is done the line can be any convenient length, radiation will be eliminated, and substantially all the power fed into the line will be delivered to the antenna.

Practically all r.f. transmission lines have fairly low impedance — 600 ohms or less — so that the line usually is terminated near the center of the antenna where the antenna impedance also is low. The termination can be made by inserting a coil at the center of the antenna (in series with a condenser so the loading effect of the coil can be cancelled) and using inductive coupling to the line, which is also provided with a coupling coil. Then by adjusting the coupling and the number of turns in each coil — while power is being supplied by the transmitter to the sending end of the line — for maximum current in the antenna and uniform current along the transmission line, the antenna impedance can be properly matched to that of the line. An untuned line is properly terminated only when the current shows no variations with distance along the line. On very long lines there may be a gradual but uniform decrease in current, but there will be no standing waves.

Terminating a line by the method just described requires that tuning apparatus be inserted in the antenna, which is inconvenient. Simpler methods make use of the fact that the

impedance of an antenna varies through a wide range of values along its length, and depend for the impedance match upon connecting the line to the proper point along the antenna or, when this is not practicable, by the use of linear matching devices. The need for tuning apparatus at the antenna is thereby eliminated.

## Single-Wire Feed

● The single-wire matched-impedance feed system operates on the same principle as the two-wire line, the return circuit being considered to be through the "mirror" effect of the ground. There will be no standing waves on the feeder when its characteristic impedance is matched by the impedance of the antenna at the connection point. The principal dimensions are the length of the antenna  $L$ , Fig. 1611, and

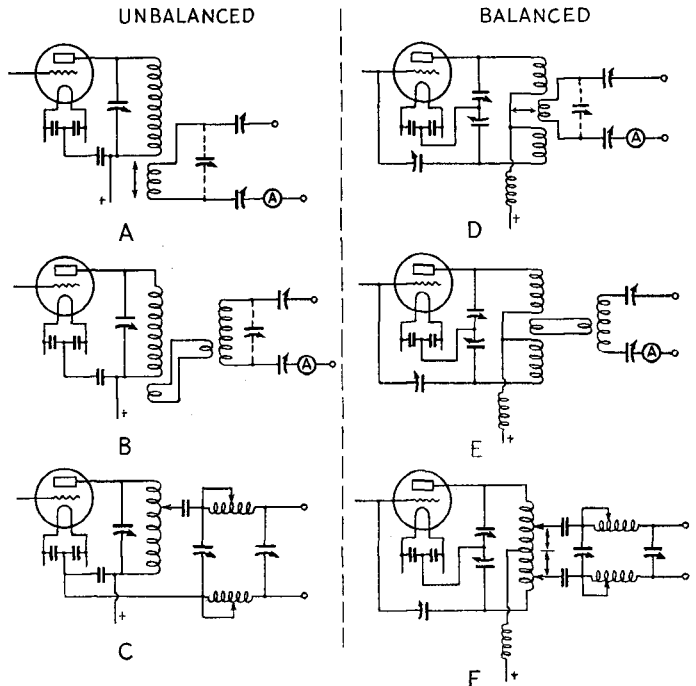
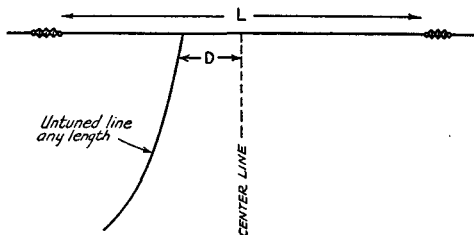

FIG. 1610 — VARIOUS METHODS BY WHICH ZEPP OR CENTER-FEEDING TUNED TRANSMISSION LINES MAY BE COUPLED TO THE OUTPUT CIRCUIT

the distance  $D$  from the exact center of the antenna to the point at which the feeder is attached. Approximate dimensions can be obtained from Fig. 1612 for an antenna system having a fundamental frequency in any of the amateur bands. Although the dimensions shown in the chart are for the 3500-ke. band,

# The Radio Amateur's Handbook . . . . .



**FIG. 1611 — SINGLE-WIRE FEED SYSTEM**

The length *L* (one-half wavelength) and *D* are determined from the chart, Fig. 1612.

the dimensions for the 7000-kc. band can be obtained by multiplying the frequency by 2 and dividing the lengths by 2; and for the 14,000-kc. band by multiplying the frequency by 4 and dividing the lengths by 4.

In constructing an antenna system of this type the feeder must run straight away from the antenna (at a right angle) for a distance of at least  $\frac{1}{2}$  the length of the antenna. Otherwise the field of the antenna will affect the feeder and cause faulty operation of the system. There should be no sharp bends in the feeder wire at any point.

Correct antenna length and placing of the feeder should be checked experimentally if best results are to be obtained. Unless this is done, this type of antenna feeding may lead to considerable trouble. If, for instance, impedances are not correctly matched, standing waves will appear upon the line and the entire system, including the feeder, may resonate, placing the entire transmitter above ground potential resulting in instability and high r.f. potentials at undesirable points in the circuit. A good ground connection should be made to the filament center-tap or center point of the filament by-pass condensers when this system is used. The presence of standing waves may be detected most accurately by placing a

low-reading thermo-ammeter at several points along the transmission line. The reading should be substantially constant all along the line with no indication of pronounced increases or decreases.

This antenna system, as well as all other untuned line systems, cannot be operated at harmonics and still maintain the characteristics of an untuned line system. It is occasionally used for harmonic operation but always with the feeder as well as the antenna radiating.

Several methods of coupling to the output circuit are shown in Fig. 1613. With an un-

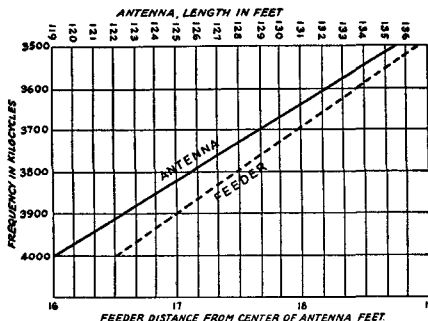

**FIG. 1612 — SINGLE-WIRE FEED DATA CHART FOR NO. 14 WIRE FEEDER**

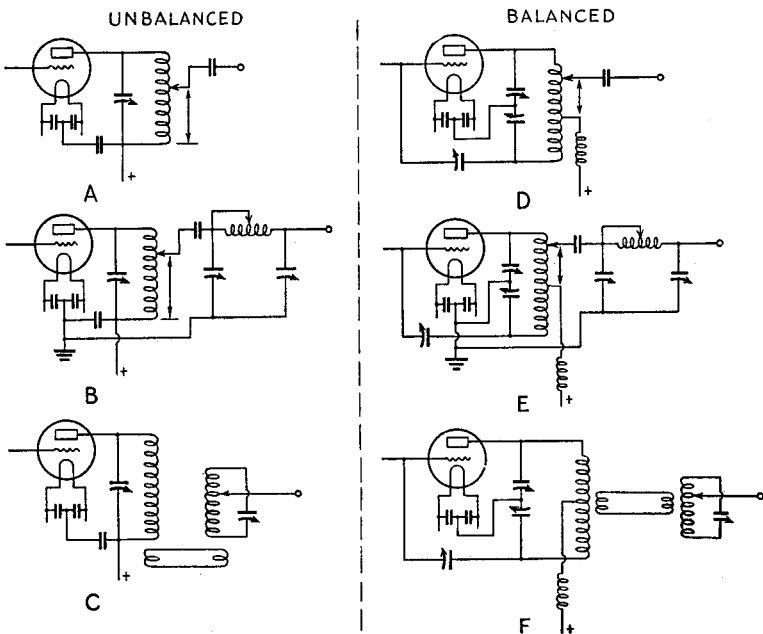

**FIG. 1613 — COUPLING THE SINGLE WIRE**  
Untuned transmission line to balanced and unbalanced output circuits.

balanced output circuit the feeder may be tapped directly on the output tank circuit coil. Starting at the ground end of the tank coil, the tap is moved towards the plate end until the amplifier draws the rated amount of plate current. The condenser in the feeder is for the purpose of insulating the antenna system from the high voltage plate supply when series plate feed is used. It should have a voltage rating somewhat above that of the plate supply. Almost any capacity greater than 500  $\mu\text{fd}$ s. will be satisfactory. The condenser is unnecessary, of course, if parallel plate feed is used. In coupling to balanced output circuits, the inductive method shown at F is preferred. The antenna tank circuit should tune to resonance at the operating frequency and the tap is adjusted as explained previously. Regardless of the type of coupling, a good ground connection is essential with this system.

### Two Wire Systems

● Unless some serious mechanical objection presents itself, two wire transmission lines are preferable to the single wire type. Ground plays no important part with the two wire line and they are in most cases no more difficult to adjust correctly. As far as effectiveness goes, there is little to choose between the several to be discussed. Some may fit individual installations better than others, while some may be somewhat easier to adjust than others.

### Twisted-Pair Feeders

● It is evident from the formula for characteristic impedance previously given that the closer the spacing and the larger the wires, the lower will be the impedance. It happens that the impedance of a two-wire line composed of twisted No. 14 rubber-covered wire of the type used in house wiring will be approximately that of the center of the antenna itself, thus simplifying the method of connecting the line to the antenna. Such discrepancy as may exist between line and antenna impedance can be compensated for by a slight fanning of the line where it connects to the two halves of the antenna, as shown in Fig. 1614.

The twisted line is a convenient type to use, since it is easy to install and the r.f. voltage on it is low because of the low impedance. This makes insulation an easy matter. The losses are slightly higher than those in spaced lines, however. Special twisted line for transmitting purposes, having lower losses than ordinary rubber-covered wire, is available. It is known as "EO-1" cable.

The antenna should be one-half wavelength long for the frequency of operation as deter-

mined by the formula for the length of a Hertz antenna. It is probable that the losses incurred by the use of this type of line are somewhat higher than those with the open type of line to be discussed immediately because of the superior insulation possible with the open line, especially when exposed to weather. On the other hand, proper operation is obtained by a few simple adjustments.

### The "Doublet" Antenna

● A third type of matching is used in the "doublet" type of antenna shown in Fig. 1615. The section *E* is "fanned" to have a gradually increasing impedance so that its impedance at the antenna end will be equal to the impedance of the antenna section *C*, while the impedance at the lower end matches that of a practicable transmission line.

The antenna length *L*, which is one-half wavelength for the operating frequency, the feeder clearance *E*, the spacing between centers of the feeder wires *D*, and the coupling length *C* are the important dimensions of this system. The system must be designed for exact impedance values as well as frequency values and the dimensions are therefore more critical than those of tuned feeder systems.

The length of the antenna is figured as follows:

$$L \text{ (feet)} = \frac{492,000}{F} \times K; \text{ or}$$

$$L \text{ (meters)} = \frac{150,000}{F} \times K$$

where *L* is the antenna length in feet or meters for a desired fundamental frequency *F*, and *K* is a constant depending on the frequency. For frequencies below 3000 kc. (wavelengths above

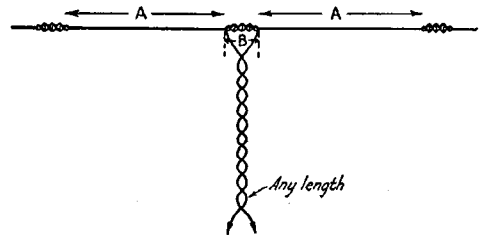

**FIG. 1614 — A HALF-WAVE ANTENNA CENTER-FED BY A TWISTED PAIR LINE**

*An improved impedance match often will result if the antenna end of the line is fanned out in the shape of a "V" for the last 18 inches or so of its length. Two insulators also should be used at the center of the antenna so the open end of the "V" will be approximately 18 inches wide. "A" plus "A" should equal one-half wavelength for the operating frequency. (See formula.)*

100 meters)  $K$  is 0.96; for frequencies between 3000 and 28,000 kc.,  $K$  is 0.95; and for frequencies above 28,000 kc.,  $K$  is 0.94.  $F$  is the frequency in kc.

The length of the antenna section  $C$  is computed by the formula:

$$C \text{ (feet)} = \frac{492,000}{F} \times K_1; \text{ or}$$

$$C \text{ (meters)} = \frac{150,000}{F} \times K_1$$

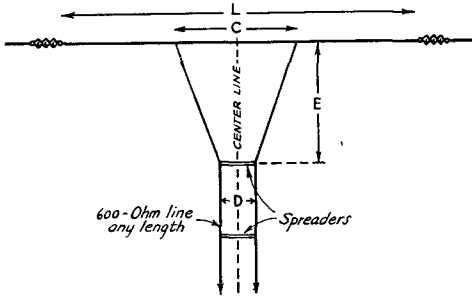

FIG. 1615 — TWO-WIRE MATCHED-IMPEDANCE ANTENNA SYSTEM

The dimensions  $L$ ,  $C$ ,  $D$ , and  $E$  are given in the text. It is important that the matching section,  $E$ , comes straight away from the antenna without any bends.  $L$  is one-half wavelength long for the operating frequency. (See formula.)

$K_1$  is 0.25 for frequencies below 3000 kc., 0.24 for frequencies between 3000 and 28,000 kc., and 0.23 for frequencies above 28,000 kc.

The feeder clearance  $E$  is worked out from the equation:

$$E \text{ (feet)} = \frac{147,600}{F}; \text{ or}$$

$$E \text{ (meters)} = \frac{45,000}{F}$$

The above equations are for feeders having a characteristic impedance of 600 ohms and will not apply to feeders of any other impedance. The proper feeder spacing for a 600-ohm transmission line is computed to a sufficiently close approximation by the following formula:

$$D = 75 \times d$$

where  $D$  is the distance between the centers of the feeder wires and  $d$  is the diameter of the wire. If the wire diameter is in inches the spacing will be in inches and if the wire diameter is in millimeters the spacing will be in millimeters.

The "Q" Antenna

● The impedance of a two-wire line of ordinary impedance (400 to 600 ohms) can be

matched to the impedance of the center of a half-wave antenna by the use of a quarter-wave line of special characteristics which acts as a matching transformer. The quarter-wave section must have a low surge impedance and therefore is commonly constructed of large-diameter conductors such as aluminum or copper tubing, with fairly close spacing. This type of antenna can be purchased in kit form and is known as the "Q" antenna. It is shown in Fig. 1616. The important dimensions are the length of the two halves of the antenna,  $A$ , the length of the matching section,  $B$ , the spacing between the two conductors of the matching section,  $C$ , and the impedance of the untuned transmission line connected to the lower end of the matching section.

The curves of Fig. 1617 show the required surge impedance for the matching section when connected to a current loop in antennas of several different lengths, using several values of untuned line impedance. A quarter-wave section matching a 600-ohm line to the center of a half-wave antenna, for example, should have a surge impedance of 212 ohms. Values for lines of other impedances can be found by interpolation. The spacings between conductors of various sizes of tubing and wire for different surge impedances are given in graphical form in Fig. 1618. With half-inch tubing, for example, the spacing should be 1.6 inches for an impedance of 212 ohms.

The length,  $B$ , of the matching section should be equal to a quarter wavelength in space. The length of the antenna can be calculated from the formulas given earlier in this chapter. It should be kept in mind that if the antenna is several half-waves long the matching section

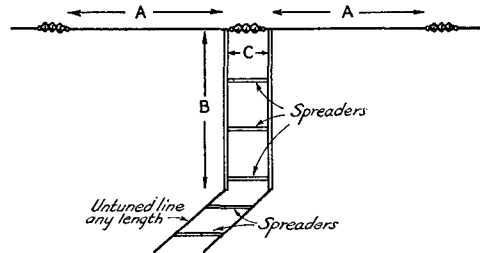

FIG. 1616 — THE "Q" ANTENNA WITH QUARTER-WAVE MATCHING SECTION USING SPACED TUBING

Antenna length,  $A$  plus  $A$ , can be calculated from the formula given earlier in this chapter for a one-half wavelength hertz antenna. The matching section length,  $B$ , in feet, is equal to  $234,000/\text{freq. in kc.}$ , or  $234/\text{freq. in mc.}$  The spacing,  $C$ , depends upon the impedance of the untuned line, and can be found from the charts of Figs. 1617 and 1618.



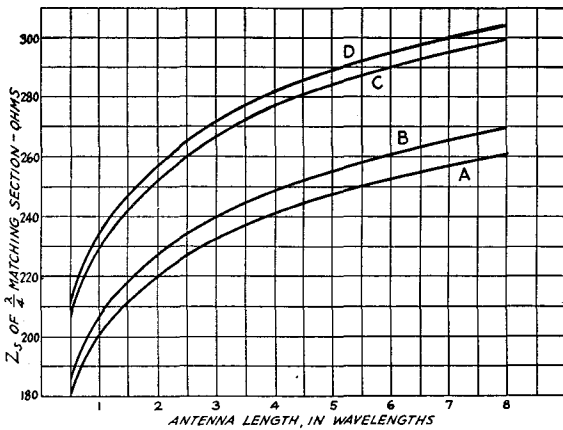

FIG. 1617 — REQUIRED SURGE IMPEDANCE OF QUARTER-WAVE MATCHING SECTIONS FOR RADIATORS OF VARIOUS LENGTHS

Curve A is for a transmission line impedance; ( $Z_L$ ) of 440 ohms, Curve B for 470 ohms, Curve C for 580 ohms and Curve D for 600 ohms.

must be connected an odd number of quarter waves from one end of the antenna.

An antenna with this type of transmission line may be operated at its harmonics, if the total length of the transmission line is suitable, by tuning the line as described previously for the center-fed antenna with tuned transmission lines. The system is operating as a "Q" only at the fundamental frequency, of course.

This system has the advantage of the

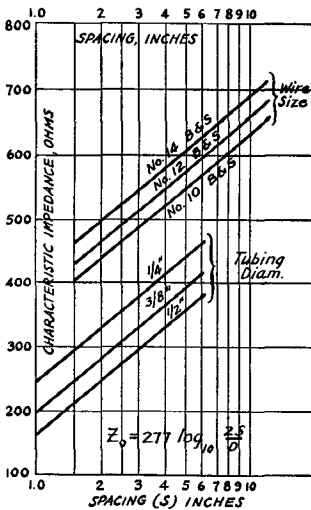

FIG. 1618 — GRAPHICAL TABLE OF CHARACTERISTIC IMPEDANCES OF TYPICAL SPACED-CONDUCTOR TRANSMISSION LINES

simplicity in adjustment of the twisted pair feeder system and at the same time the superior insulation of an open wire system.

### Concentric Transmission Line

The characteristic surge impedance of an open two-wire line is given by the following formula:

$$Z = 276 \log \frac{b}{a}$$

where  $Z$  is the desired surge impedance in ohms,  $b$  is the wire spacing (center to center) in inches and  $a$  is the wire radius (half the diameter) in inches. The impedance at the center of a half-wave antenna is approximately 70 ohms. A little figuring

will show that it would be physically impossible to construct an open wire line with a characteristic impedance as low as 70 ohms. It is for this reason that an open wire untuned transmission line cannot be directly inserted at the center of an antenna and that various means have been suggested previously for matching the transmission line and antenna impedances.

If, however, the line is made in the form of two concentric conductors, the formula for surge impedance becomes:

$$Z = 138 \log \frac{b}{a}$$

where  $Z$  is the characteristic impedance desired,  $b$  is the inside diameter of the outer con-

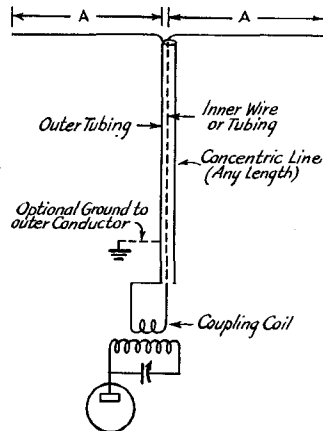

FIG. 1619 — HALF-WAVE ANTENNA WITH CONCENTRIC TRANSMISSION LINE

A plus A should be one-half wavelength as determined by formula for Hertz antenna. See text for suitable transmission line dimensions.

ductor and  $a$  is the *outside diameter (not radius)* of the inner conductor. From this formula it will be seen that a line with a characteristic impedance of 70 ohms is physically possible. The inside diameter of the outer conductor should be approximately 3.2 times the outside diameter of the inner conductor to provide the required impedance.

These conditions will be fulfilled if the outer conductor is standard  $\frac{5}{16}$  inch outside diameter copper tubing and the inside conductor is No. 14 wire. Ceramic insulating spacers are available commercially for this particular line.

Such a line may be connected directly to the center of a half-wave antenna as shown in Fig. 1619. It may be most conveniently coupled to the output circuit by means of a simple pick-up coil the number of turns in which is varied for proper amplifier loading, or by means of the pi-section filter. The outer conductor may be grounded, if desired, without affecting the operation of the system.

**Matching by Linear Transformers**

● A quarter-wave line of ordinary construction (spaced wire) can be used as a matching transformer in somewhat similar fashion to the

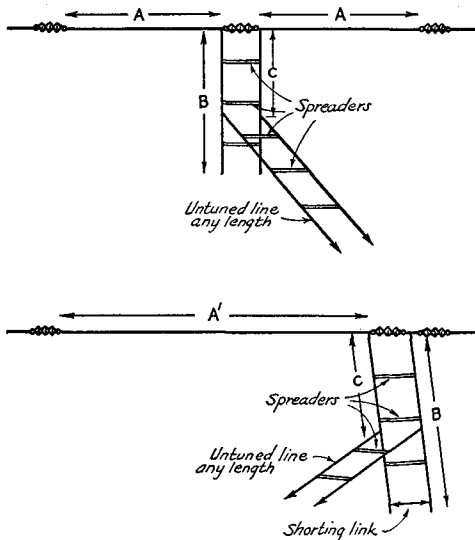

**FIG. 1620 — IMPEDANCE-MATCHING ANTENNA SYSTEMS WITH QUARTER-WAVE OPEN WIRE MATCHING TRANSFORMERS**

Antenna dimensions,  $A$  plus  $A$  in upper figure,  $A'$  in lower, can be found from the formulas for one-half wavelength antennas earlier in this chapter. The dimension  $B$ , one-quarter wavelength, in feet, is equal to  $234,000/\text{freq. in kc.}$ , or  $234/\text{freq. in mc.}$  The dimension  $C$  must be found by experiment, as described in the text.

matching section in the "Q" type antenna just described. The open-wire quarter wave section cannot satisfy the conditions for impedance match between an antenna and feed line when these are connected to its ends, however. It is therefore necessary to obtain

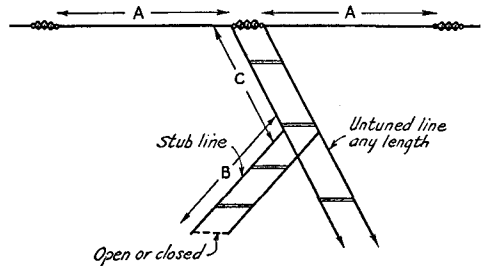

**FIG. 1621 — ANTENNA SYSTEM WITH CORRECTIVE STUB FOR IMPEDANCE MATCHING**

The formulas for one-half wavelength antennas given earlier in the chapter give the antenna length,  $A$  plus  $A$ , each half being a quarter wave. The stub length,  $B$ , and point of attachment to the non-resonant line,  $C$ , can be found from the data in Fig. 1622.

the match by tapping the line at an appropriate point along the matching section, as shown in Fig. 1620. The impedance of a quarter-wave resonant line varies from a low value at one end to a high value at the other, as we have already pointed out, hence a point along the line can be found to match practically any type of transmission line.

Assuming that the antennas in Fig. 1620 have a length of one-half wave, the matching section in the center-fed system will be open-ended at the bottom, while the lower end will be closed in the end-fed system. In each case the length  $B$  will be a quarter wavelength in space; in the end-fed system this length can be adjusted by moving the shorting link, while in the center-fed system the length must be adjusted by cutting the wires. If the matching section is extended to a half wave in the center-fed system, a shorting link can be used at the lower end for adjustment. The length of the antenna can be found from the formulas previously given,  $A$  being a quarter wave and  $A'$  the full half wave.

To adjust these systems it is necessary to move the untuned line taps along the matching section until the current throughout the line is uniform. Standing waves on the line indicate a mismatch between line and antenna. It is important that the antenna length, as well as the matching section length, be correct. If they are not, a satisfactory match is practically impossible of attainment.

The position of the taps will depend upon

the impedance of the line as well as the impedance of the antenna at the point of connection to the matching section. In general, the correct position can be found only by experiment.

### Corrective Stub Matching

● A method of matching which resembles that just described employs a so-called "corrective stub" line whose length and point of attachment are adjusted to eliminate standing waves on an untuned transmission line connected to the center of an antenna. This system is shown in Fig. 1621. To use the corrective stub it is necessary to measure the current along the line without the stub, noting the positions of current maxima and minima, as shown in Fig. 1622. The table gives the length and position of the corrective stub for various maximum-to-minimum current ratios. An open stub is used near a current maxima and a closed stub near a current minima.

The stub performs much the same function as the matching section, but can be inserted at any convenient point along the transmission line, two positions being possible for every half wavelength of line.

Because of the requirement of one-quarter

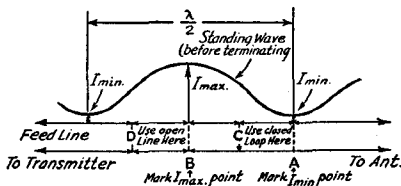

FIG. 1622 — SHOWING THE TWO POINTS, D OR C, AT WHICH THE AUXILIARY OPEN LINE OR CLOSED LOOP MAY BE PLACED, POINT D TAKING THE LINE AND POINT C THE LOOP

Only one or the other is used, depending upon the position selected on the feeder line.

Ratio $I_{max}/I_{min}$	Distances		Length of Line (For D)	Length of Loop (For C)
	B to D	A to C		
0.9	0.123λ	0.128λ	0.02λ	0.232λ
0.8	0.119λ	0.134λ	0.04λ	0.210λ
0.7	0.114λ	0.139λ	0.06λ	0.191λ
0.6	0.108λ	0.143λ	0.08λ	0.170λ
0.5	0.100λ	0.153λ	0.10λ	0.150λ
0.4	0.090λ	0.162λ	0.122λ	0.130λ
0.3	0.080λ	0.173λ	0.146λ	0.105λ
0.2	0.068λ	0.187λ	0.170λ	0.080λ

Distances and lengths of the line or loop are given in terms of λ or one wavelength. Wavelength, λ, in meters, equals 300,000 divided by frequency in kilocycles. One meter equals 3.28 feet.

wavelength sections, it should be obvious that the linear transformer and corrective stub systems as well as the "Q" arrangement are useful, in most cases, only at the higher frequencies where dimensions become reasonable for the space commonly available to the average amateur.

### Construction and Adjustment of Open-Wire Lines

● Since the wire spacing is the critical dimension in determining the impedance of an untuned line, it is essential that the wires be kept taut and uniformly spaced throughout the length of the line. This calls for the use of suitable spacers at frequent intervals along the line. The line may be transposed by using transposition insulators available from a number of manufacturers, but for transmitting work a non-transposed line is generally preferable. The line may be run around corners if suitably insulated and rigidly supported, but sharp bends in the wires must be avoided, since they cause a change of impedance.

In any of the matched systems, with the possible exception of the "Q" type when calculations have been carefully made and the line and matching section spacing is adjusted with equal care, the performance of the line should be checked in actual operation to make certain that standing waves are eliminated. This can be done by measuring the current in the wires, using a device of the type pictured in Fig. 1623. The hooks (which should be sharp enough to cut through insulation, if any, of the wires) are placed on one of the wires, the spacing between them being adjusted to give a suitable reading on the meter. At any one position along the line the currents in the two wires should be identical. Readings taken at intervals of a quarter wavelength will indicate whether or not standing waves are present; if the readings differ by more than a few percent the line is not properly matched to the an-

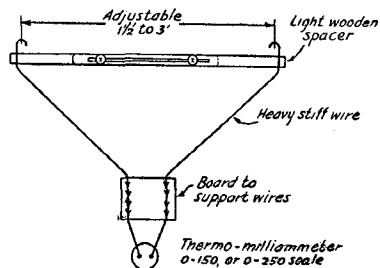

FIG. 1623 — LINE-CURRENT MEASURING DEVICE FOR ADJUSTMENT OF UNTUNED TRANSMISSION LINES

tenna. In that case the termination should be adjusted to bring the readings at quarter-wave intervals to the same value.

An impedance mismatch of a few percent is of little consequence so far as power transfer to the antenna is concerned. However, the presence of standing waves on the line increases the line losses and may be responsible for radiation which causes interference to nearby receivers and possibly extra losses in house-wiring circuits near which the transmission line must pass.

### Coupling To Untuned Lines

● Similar coupling methods are used with all types of two-wire transmission lines, whether of high or low impedance. Several systems are shown in Fig. 1624. The inductively coupled methods are preferable to direct coupling when a single-ended tank circuit feeds a balanced transmission line; this avoids line unbalance which might occur with direct coupling. In the direct-coupled circuits, the fixed condensers are useful only when the output amplifier plate supply is series-fed. These condensers, when used should have a rating somewhat above the maximum plate voltage used and

to give maximum line current with normal tube plate current.

### Collins Multi-band Antenna

● The Collins "multi-band" antenna system shown in Fig. 1625 provides something of a compromise between a system with tuned feeders and one with an untuned transmission line. Standing waves are present on the feeders, but the design of the transmission line limits them to a low amplitude by providing an approximate impedance match between the antenna and the transmission line at all amateur band frequencies. The following is based upon information taken from the "Collins Signal."

In practice the impedance at the center of a horizontal antenna varies between about 75 ohms and 1200 ohms as the frequency is varied. The lower values occur when the antenna length is one-half wavelength, three one-half wavelengths, five one-half wavelengths, etc., and the impedance is highest for frequencies making the antenna length one or more full wavelengths long. If a transmission line with a characteristic of 300 ohms (the geometric mean between 75 and 1200) is used, the stand-

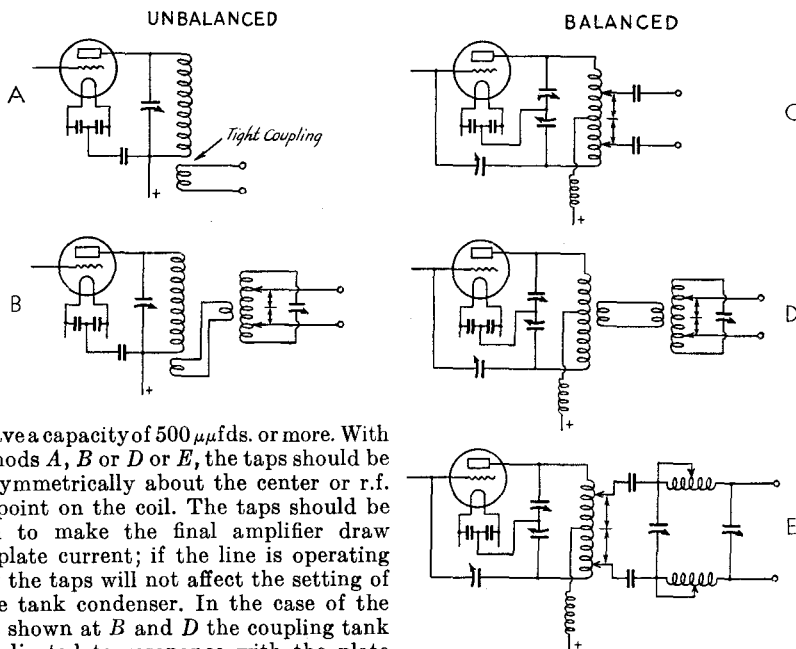

should have a capacity of 500  $\mu\text{f}$ ds. or more. With the methods A, B or D or E, the taps should be placed symmetrically about the center or r.f. ground point on the coil. The taps should be adjusted to make the final amplifier draw normal plate current; if the line is operating properly the taps will not affect the setting of the plate tank condenser. In the case of the methods shown at B and D the coupling tank is first adjusted to resonance with the plate tank circuit, using loose coupling; the taps are then set at trial positions and the current in the line measured. The tap positions and coupling between the coils are then adjusted

FIG. 1624 — SUITABLE METHODS FOR COUPLING OUTPUT CIRCUITS TO ALL TYPES OF TWO-WIRE UNTUNED TRANSMISSION LINES INCLUDING TWISTED PAIR LINES, CONCENTRIC LINES AND OPEN WIRE LINES

ing waves will be at a minimum at all frequencies, and the input impedance will remain at all times a manageable value not exceeding 1200 ohms. A 300-ohm line can be constructed

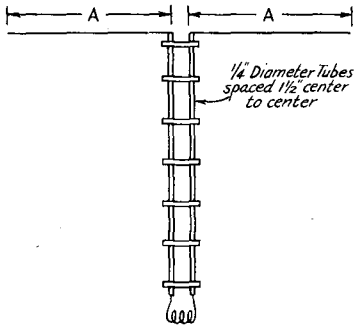

FIG. 1625 — COLLINS "MULTIBAND" ANTENNA SYSTEM

The antenna length mentioned in the accompanying table refers to the dimensions  $A$  plus  $A$  in the drawing.

of two one-quarter inch tubes spaced one and one-half inches by means of ceramic blocks at intervals of about 20 inches. The blocks can be located by crimping the tube slightly on either side of the block. A 50 foot copper line of this type weighs 10.9 pounds and is not difficult to support from the center of the antenna. If necessary, aluminum instead of copper tubing may be used to reduce the load on the antenna supports when the vertical part of the transmission line is greater than 50 feet. In practice, slight unbalances in a 600-ohm line materially reduce the efficiency, whereas the 300-ohm line is not so susceptible to loss in efficiency.

An antenna may be made to work very efficiently over a wide frequency range and with any antenna impedance between 75 and 1200 ohms by the simple expedient of using a specially constructed transmission line. The accompanying table shows several combinations of suitable dimensions. In each case, the length of the transmission line is so chosen that the reactance at the transmitter end is negli-

ble and the line can be coupled to the output tank circuit of the transmitter by a simple pick-up coil. In cases when it is not convenient to use a transmission line as long as shown in the table, it is, of course, entirely practicable to reduce the line to a convenient value and build out the equivalent electrical length by inserting an impedance matching network between the transmitter and the line. When such a network is used the line can be made any length and then the only important dimension is that of the antenna itself. The only precaution which should be observed is that the transmission line should not be  $\frac{1}{8}$ ,  $\frac{3}{8}$ ,  $\frac{5}{8}$ , etc., wavelength long at any of the operating frequencies.

### Pi-section Coupling Filters

● The pi-section network shown frequently in the diagrams referring to antenna coupling in this chapter has certain features not possessed by other methods of coupling. Its greatest disadvantage is that unless it is correctly adjusted, it may emphasize effects which it is designed to eliminate. Therefore, special attention should be paid to adjustment when it is used. When correctly adjusted, it forms an excellent means of matching impedances between the output circuit and transmission lines of most types, or directly excited antennas. It effects suppression of harmonics and sometimes more efficient transfer of energy to the transmission line or antenna. It obviates the necessity for providing a mechanical arrangement for varying the position of the usual coupling coil used with directly excited antennas and tuned transmission lines. It also provides a ready means of varying the load on the output amplifier within a reasonable range.

Two common forms are shown in Fig. 1626. The function of impedance matching is provided for in the ratios of the capacities of the two condensers  $C_1$  and  $C_2$  which are variable over a range sufficient to take care of most transmitting tubes and antenna feeding systems. Because of its ability to match impedances of widely different values, the net-

Antenna Length — Feet	136	136	275.5	250	67	67	103
Feeder Length — Feet	66	115	99	122	65	98	82.5
Frequency Range — Mc.	3.7-4.0 7.0-7.3 14.0-14.4	3.7-4.0 14.0-14.4	1.7-2.0 3.7-4.0 7.0-7.3 14.0-14.4	1.7-2.0 3.7-4.0	7.0-1.3 14.0-14.4 28.0-29.0	7.0-7.3 14.0-14.4 28.0-29.0	3.7-4.0 7.0-7.3 14.0-14.4
Nominal Input — Impedance	1200Ω All bands	75Ω All bands	1200Ω 160-80-20M 375Ω 40M	1200Ω All bands	75Ω-40M 1200Ω-20M 10M	1200Ω All bands	1200Ω All bands

work may be used to feed a wire considerably shorter than one-half wavelength long for the frequency of operation; in fact, power may be fed to a wire of any random length within reason considering frequency. This does not

lines or center fed antennas. Suitable values of capacity and inductance are specified under the diagrams.

Adjustment is as follows: With the filter disconnected, tune the amplifier or oscillator to resonance — the point of plate current minimum. Set the taps on  $L_1$  (and  $L_2$ , if used) approximately as indicated under the circuit diagram for the band in use. Connect the filter to the tank circuit, placing the tap or taps about midway between the ground point and the end or ends of the coil. Set  $C_2$  at about half maximum capacity. Apply plate voltage (reduced, if possible) and rotate  $C_1$  rapidly to find the point of plate current dip. This dip will not be the no-load plate current value but probably will be to a value nearer the rated plate current of the tube. If it is impossible to find resonance over the range of  $C_1$ , a different setting of  $C_2$  should be tried. This failing, the inductance tap or taps should be adjusted. With the two-wire coupler, the number of turns in circuit should be the same in each of the two coils.

Adjustment of  $C_2$  should provide a fairly wide range of input to the final amplifier. Loading may increase with either increase or decrease of capacity  $C_2$  depending upon characteristics of the transmission line or antenna at the point of coupling. Each time the capacity of  $C_2$  is changed,  $C_1$  should be retuned for minimum plate current. In case it is found impossible to load the amplifier up to normal plate current with any setting of  $C_2$ , the number of turns on the final amplifier tank coil between the tap or taps and ground should be increased. If, on the other hand, the tuning of the coupler appears to be sluggish with no pronounced indications of working properly, the number of turns between the tap or taps and ground should be decreased. In coupling to balanced output circuits, the taps should be maintained equidistant from ground.

Once the final amplifier tank circuit has been tuned to resonance with the coupler disconnected, it should not be touched again. If the antenna coupler is correctly adjusted, it will be found that the tuning of the plate tank circuit has not been disturbed by coupling the antenna. Should retuning give a new minimum plate current point, the filter is not correctly adjusted.

### Link-Coupled Antenna Tuning Unit

● A modification of inductive coupling resembling the link line used in interstage coupling circuits is shown in Fig. 1627. This system is particularly useful where tuned feeders are to be used and their length does not permit running right to the transmitter. The twisted line

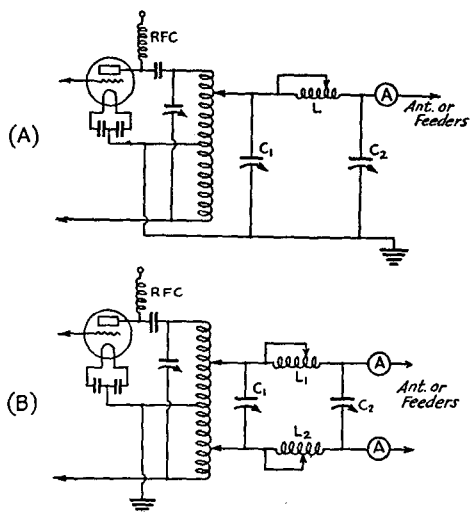

FIG. 1626 — ANTENNA-COUPLING FILTERS

Their use and adjustment is explained in the text. Condensers  $C_1$  and  $C_2$  should have a maximum capacity of 250  $\mu\text{fd.}$  or more, with plate spacing sufficient to withstand the r.f. voltages developed by the transmitter. For powers up to 50 watts, receiving-condenser spacing will be satisfactory; for higher power, transmitting-type condensers should be used.

For operation from 1.75 to 14 mc., the inductance should be 30 turns wound to a  $2\frac{1}{2}$ -inch diameter and  $5\frac{1}{2}$  inches long, tapped every five turns. Approximate settings are 30 turns for 1.75 mc., 15 turns for 3.5 mc., 10 turns for 7 mc., and 5 turns for 15 mc.  $L_1$  and  $L_2$  should have half the turns specified for  $L$ . The coils may be wound with No. 12 or No. 14 wire.

mean that it will increase the radiating qualities of a short wire, but it does make it possible to excite a wire less than usual length when space limitations make a short wire necessary. The requirements for a good radiator still hold.

Tuned transmission lines, when coupled by means of the impedance matching network, may be cut to any convenient length. The network has nothing whatsoever to do with impedance matching between the transmission line and the antenna, unless it is placed between the transmission line and the antenna itself.

Of the two arrangements shown in Fig. 1626, A should be used in all cases where a single wire transmission line or end-fed antenna is to be coupled. The arrangement at B should be used for all two wire transmission

may be any reasonable length, so that the transmitter and antenna-tuning apparatus can be some distance apart. This system helps to reduce the effects of a reactive load upon the output amplifier circuit.

The antenna tuning unit indicated is arranged for either series or parallel tuning. To adjust the system, the plate tank is first tuned to resonance. The line is then coupled to the tank (a turn or two usually will be enough), and the antenna tuning adjusted to bring the plate current to maximum. Coupling can be changed by increasing the spread between the

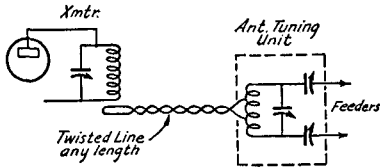

**FIG. 1627 — LINK COUPLING BETWEEN THE TRANSMITTER AND ANTENNA TUNING APPARATUS**

*This system eliminates variable inductive coupling and permits placing the antenna tuning apparatus at any convenient point.*

taps on the antenna coil or by increasing the number of turns in the link coil at the transmitter end.

As a variation, a link turn can be used at the antenna tuning-unit end with the taps on the plate tank coil, or inductively-coupled links can be used at both ends.

### Directional Effects of Hertz Antennas

● The direction or directions in which the greatest amount of radio-frequency energy is radiated from a Hertz antenna varies with its length (measured in wavelengths), its height above ground, and the character of the ground and surrounding objects. If the antenna were in free space, i.e., remote from ground and other objects, its directional characteristic would be as shown in Fig. 1628. Although shown plane, these figures should be imagined as being rotated about the line of the antenna as an axis, since the radiation characteristic is three-dimensional. Thus the radiation characteristic of a half-wave antenna will resemble a doughnut in shape, with the axis of the wire running through the hole; the full-wave characteristic will resemble two cones point to point, etc.

When a center-fed antenna is operated at its harmonics, the two halves operate in phase. This sort of operation changes the radiation pattern from that obtained with end feed. The radiation pattern of the full-wave antenna fed

at the center will be similar to the pattern shown for the half-wave antenna, that of the two wave antenna fed at the center will resemble the pattern shown for the full-wave antenna, the four wave center-fed antenna will have a pattern resembling that shown for the two wave antenna, etc. In each case, the

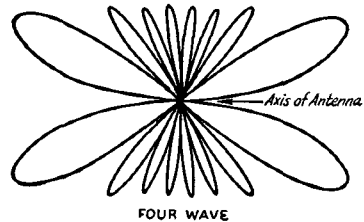
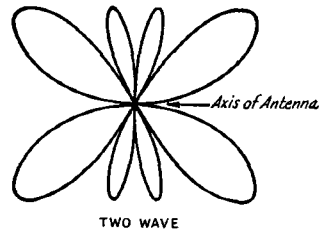
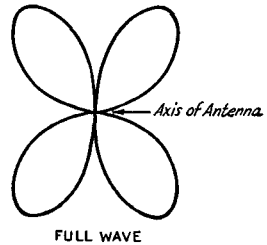
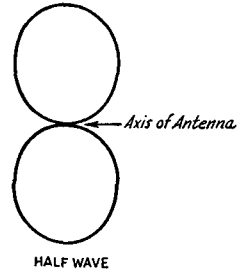

**FIG. 1628 — CROSS-SECTIONS OF SPACE DIRECTIONAL PATTERNS OF HERTZ ANTENNAS**

*The lobes are drawn to scale, and are based on the assumption that the same power is supplied to the antenna in each case. An actual picture of the radiation characteristic in space can be obtained by imagining the drawings rotated about the line of the antenna as an axis.*

lobes will be somewhat narrower and more extended than indicated.

### Angle of Radiation

● When the antenna is suspended above the ground its directional characteristic is changed because some of the energy radiated toward the ground is reflected back into space. The reflected energy reinforces the original space radiation at certain angles in the plane perpendicular to earth and cancels it in others. The ground therefore affects the *angle of radiation*, discussed in Chapter Four. The effect of the ground depends upon the position of the antenna with respect to earth (vertical, horizontal, etc.), its height above ground, and the characteristics of the ground itself. If the ground is a good "electrical mirror" the vertical radiation will be reinforced and the horizontal radiation cancelled when a horizontal antenna is a quarter wavelength above the ground. As the height is increased, radiation at lower angles is reinforced, although purely horizontal radiation always is cancelled with the horizontal antenna. On frequencies where low-angle radiation is desirable, particularly 14 mc., and higher, a horizontal antenna always should be at least a half wavelength (about 35 feet) above ground, and preferably higher.

The effect of the ground is exactly the same with a vertical antenna an even number of half-waves long; that is, horizontal radiation is cancelled. Thus a vertical antenna should not be a full wave long if very low-angle radiation is wanted. With an antenna an odd number of half-waves long, however, the ground will in general reinforce the low-angle radiation regardless of height. Vertical antennas are

ordinarily used only for 14 mc. and higher frequencies because of constructional difficulties at the lower frequencies.

Fig. 1628 shows that as the antenna length is increased the major radiation lobe (each loop or cone of radiation is known as a "lobe") makes a smaller angle with the axis of the wire. Since this applies in all planes, long-wire antennas are lower-angle radiators than short antennas. A horizontal antenna one or two wavelengths long at a height of from one-half to one wavelength above ground will be a quite effective low-angle radiator at 14-mc. The angle which the major radiation lobes make with the antenna wire are shown in Fig. 1629 as a function of the antenna length.

The foregoing discussion should make it plain that the drawings of Fig. 1628 are not pictures of the directivity of a horizontal antenna viewed from above. They will represent approximately the horizontal-plane directional pattern at the lowest possible angle of radiation, but considerable radiation may take place at higher angles in directions which appear to give no radiation at all in the drawings. A half-wave horizontal antenna, for example, will be practically non-directional on frequencies where the angle of radiation is not highly important, as at 3.5 mc. On the other hand, at 14 mc. a half-wave antenna may show more pronounced directional characteristics because only the low angle radiation is effective under ordinary conditions. Such an antenna radiates best at right angles to the wire.

### Choosing the Antenna

● The choice of a suitable antenna or antennas will not present much of a problem to those who have an acre or so of clear space. However, most of us are not so fortunate. Frequently space cannot be found for more than a single antenna for all bands and many do not

have space in which to put up, in clear space, a half-wave antenna for the lowest frequency at which operation is desired. In other words, the space available usually dictates the most suitable type of antenna possible.

A vertical antenna occupies the smallest terrestrial area, it will radiate equally well in all directions unless shielded by near-by objects, and radiates chiefly at the lower angles useful for long distance communication. Unfortunately, however, supports for vertical antennas are costly, except for antennas for the higher frequencies. Reliable masts or towers which will not endanger life and property will average about one dollar per foot in cost for heights up

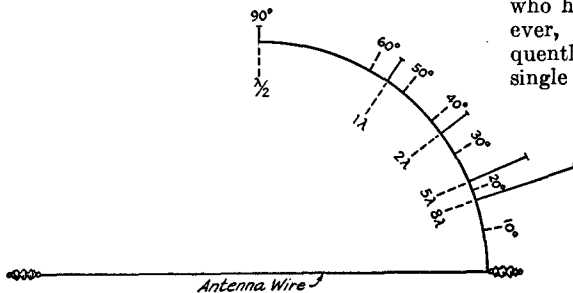

FIG. 1629 — ANGLES OF MAXIMUM RADIATION, MEASURED FROM THE LINE OF THE ANTENNA, FOR ANTENNAS OF DIFFERENT LENGTHS IN TERMS OF THE OPERATING WAVELENGTH

The angles are shown for one quadrant but correspond for the other three. The relative lengths of the extended solid lines indicating the angles of maximum lobes show power ratios compared with the maximum for a half-wave doublet (90°), assuming the same current at a current loop for each case.



to about seventy-five feet. To be most effective, the lower end of the vertical antenna should be well above surrounding objects and when located in free space, the center should be at least one-half wavelength above ground. Lesser heights will usually result in some sacrifice in performance.

In general, where one antenna must serve for all frequencies, it should be at least one-half wavelength long for the lowest frequency at which operation is desired. When this practice is followed with horizontal antennas, certain benefits result in operation at the higher frequencies. Referring back to the diagrams of antenna directivity patterns, Fig. 1628, it will be seen that the longer the antenna is in respect to the wavelength of operation, the less directive the antenna becomes. The number of lobes in the pattern increase with the antenna length and the angle of chief radiation becomes lower. Providing nearby surrounding objects are cleared, little benefit will usually result in elevating the horizontal antenna to a height greater than one-half wavelength. It will usually pay to orientate the direction of the antenna so that the main lobes of the radiation pattern point in the directions in which communication is especially desired or especially difficult. It is quite frequently possible to run the antenna in such a direction that a main lobe will fall in the approximate direction of each of several continents. Directions should be taken from a globe. Whenever possible the antenna should be located well away from telephone or power wiring or at least run at right angles to their directions.

In selecting the most suitable method of feeding the antenna, it should be remembered that antennas with tuned feeders are the only types (directly excited antennas excepted) capable of operation at harmonics. The Zepp or end-fed type is probably the most popular type not only because it is usually more convenient to feed the antenna at one end instead of the center, but also because the end-fed antenna is somewhat less directive than the center-fed antenna when operated at harmonics as pointed out previously.

#### Antennas for Limited Space

● Amateurs who are so unfortunate as to be located where space is very restricted will usually have to make up their minds to be content with something less than an ideal radiator. This concession, however, should not unduly discourage one sincerely interested in his hobby. Surprising results are often obtained with small antennas poorly located, especially at the higher frequencies.

By use of a ground connection, the antenna length for any fundamental frequency may be cut in half or somewhat shorter. Even much shorter lengths of wire may be used where necessary by winding the extra length into a coil inserted at the base of the antenna.

A center-fed antenna with tuned feeders will resonate at a lowest frequency determined by adding up the total length of the flat-top and that of each feeder. For instance, an antenna of this type with a flat-top 66 feet long and 33 foot feeders will resonate at 3.5 mc. as well as at 7 and 14 mc. and will be quite effective at the lower frequency if well elevated. Antennas of the Zepp type are occasionally operated this way although some difficulty may be experienced in feeding power into the antenna unless the feeder length happens to be right or the pi-section filter is used for coupling.

The antenna may be bent, if necessary, the two portions running in different directions. However, an attempt should be made to limit the angle of bending to angles greater than 90 degrees and, if possible, to a single bend.

One of the most unique features of the pi-section coupling network previously discussed is its ability to feed power into a wire of random length. When no better arrangement can be devised, a wire of the longest length possible, elevated as well as possible may be used for the antenna, feeding it at one end through the network.

Even indoor antennas strung up in the attic or around the picture molding of a room will make it possible to communicate frequently over moderate distances and occasionally over greater distances when operated at the higher frequencies.

#### Antenna Construction

● For the purpose of this discussion let us divide the antenna system into two parts — the conductors and the insulators. If the system is to operate most effectively the conductors must be of low resistance. On the other hand the insulators must be of the highest possible resistance. For short antennas and feeders an entirely satisfactory conductor is No. 14 gauge hard-drawn enamelled copper wire. For long antennas No. 12 gauge is preferable. Every effort should be made to make the wires in one piece so that the only joints are at the output terminals of the transmitter. Where joints cannot be avoided they should be thoroughly soldered. It should always be possible to make the Hertz antenna portion in one piece.

If the feeder system is of the tuned type the currents in it will be of the same order as those

in the antenna and the same care in avoiding joints is necessary. In the untuned feeder system, however, the currents are relatively low and this consideration is therefore not as important. In these cases smaller wire can be used if necessary.

In building a two-wire feeder the wires may be separated by wooden dowels which have been boiled in paraffin. In this way the feeder is given a tendency to swing in windy weather as a unit. When heavy glass or porcelain spacers are used the tendency is for each wire to vibrate with respect to the other, so causing changes in the capacity between the wires and consequent changes in the emitted frequency. The wooden dowels can be attached to the feeder wires by drilling a small hole in the dowels, then binding them to the feeders with wire.

A good insulation to use throughout the antenna system is Pyrex electrical-resistant glass. Glazed porcelain also is very good. It should be kept in mind that the ends of tuned feeders or the ends of the antenna are points of maximum voltage. It is at these points that the insulation is most important. A 12" Pyrex insulator is quite satisfactory for amateur transmitters of any power. For the low-powered transmitters one of the smaller sizes, or two in series, would be satisfactory.

It is hardly possible to give practical instructions for the suspension of the antenna since the methods used will vary so widely in individual instances. In most cases poles are desirable to lift the antenna clear of surround-

ings will present themselves. It will be well for the amateur to try the antenna in different positions or to try different types of antennas. Time expended in such experiment undoubtedly will be well worth while.

## The Receiving Antenna

● Because of the high sensitivity of modern receivers a large antenna is not necessary for picking up signals at good strength. Often it will be found that the receiving antenna in the amateur station is an indoor wire only 15 or 20 feet long.

On the other hand, the use of a tuned antenna unquestionably improves the operation of the receiver because the signal strength is greater in proportion to the stray noises picked up by the antenna than is the case with the antenna of random length. Likewise, it is advantageous to have the receiving antenna well out in the clear, away from power wiring which radiates the noises resulting from the use of electrical household appliances, and to bring the signal into the receiver over a radio-frequency transmission line. A non-radiating transmission line is inefficient at intercepting signals, hence it can pass through locations where noise is great without picking up much interference. The transmission-line fed antennas used for transmitting will make excellent receiving antennas; a switch can be fitted in the feeders inside the station so that the antenna can be connected to either the transmitter or receiver.

If a separate receiving antenna is preferred, a doublet antenna of the type shown in Fig. 1630 will give very good results. The length of the lamp cord transmission line may be anything convenient. The antenna itself should be a half wave long for the frequency band most used; despite the fact that the antenna is resonant for only one band, it will give good results on others as well. A popular length is 65 feet or so, designed to resonate in the 7000-kc. band.

The increasing popularity of short-wave broadcast receiving antennas has led to the development of many excellent commercial types available in kit form at reasonable prices. Designs such as the "Double-Doublet" and the "V Doublet" perform effectively for amateur work.

## Dummy Antennas

● The absolute value of current in an antenna or feeder system is practically meaningless so far as indicating actual power is concerned, because the resistance of the antenna or feeder at the point where the current is measured

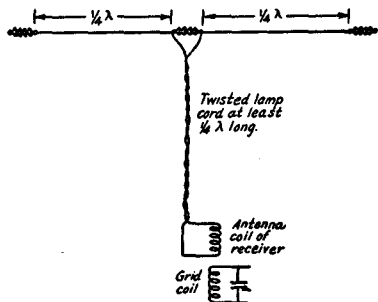

FIG. 1630 — DOUBLET RECEIVING ANTENNA

ing buildings but in some locations the antenna is in the clear when strung from one chimney to another or from a chimney to a tree. Small trees are not usually satisfactory as points of suspension for the antenna on account of their movements in windy weather. If the antenna is strung from a point near the center of the trunk of a large tree this difficulty is not as serious.

In most locations a variety of possible ar-

is rarely known. In tuning the antenna system to the transmitter the antenna ammeter's chief function is that of providing a means for comparing the effects of different adjustments. The actual power output must be measured by adopting a different method. The simplest of these is that involving the use of a non-radiating or "dummy" antenna.

Such a dummy antenna should be part of the equipment available in all good stations.

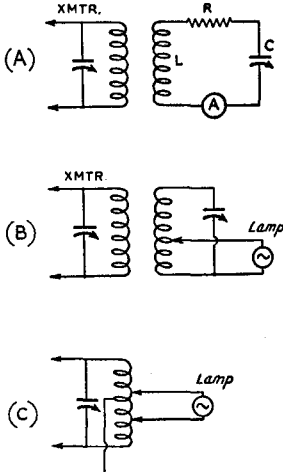

FIG. 1631 — DUMMY ANTENNA CIRCUITS

By its use, during periods of adjustment and tuning of the transmitter, much interference may be avoided.

The dummy antenna is a resistance of suitable value capable of dissipating in the form of heat all the output power of the transmitter. One of the most satisfactory types of resistors for amateur work is the ordinary incandescent electric lamp. Other non-inductive resistors of sufficient power-dissipating capacity can be used, however.

Three circuits for use with dummy antennas are given in Fig. 1631. The first of these is for use with a low-resistance dummy — say 25 ohms or less. The resistor is connected in series with a tank circuit which tunes to the same frequency as the transmitter and is coupled inductively to it. If the value of the resistance is known accurately — measurement is difficult, however, because of skin effect at high frequencies — the power may be determined by measuring the radio-frequency current in the resistor and applying Ohm's Law ( $W = I^2 R$ ). The resistor must be non-inductive.

Incandescent bulbs, which in the 115-volt sizes have a resistance of 75 ohms or more at

operating temperature for ratings of 150 watts or less, will work more satisfactorily in either of the other two circuits. The lamp should be equipped with a pair of leads, preferably soldered right to the terminals on the lamp base. The number of turns across which the lamp is connected should be varied, together with the tuning and the coupling between the dummy circuit and the transmitter, until the greatest output is obtained for a given plate input.

In using lamps as dummy antennas, a size corresponding to the expected power output should be selected so that the lamp will operate near its normal brilliancy. Then when the adjustments have been completed an approximation of the power output can be obtained by comparing the brightness of the lamp with the brightness of one of similar power rating in a 115-volt socket.

### Practical Directive Systems

● As has already been indicated, directive arrays may be used to great advantage when particularly effective transmission or reception is desired in some one or two directions. Indeed, it is sometimes practical to arrange the directive system on a rotating framework, so allowing transmission or reception with maximum effectiveness in any desired direction.

It is unfortunate that all directive systems require much greater space than simple antennas. Because of this, it is rarely possible for the amateur to erect a satisfactory array for frequencies lower than 14 mc. Even on that frequency, more than the average yard space is usually required for the erection of the system and, at that, the optimum performance of the array cannot be expected unless the space is well clear of trees and buildings.

Another factor which complicates the erection of a satisfactory array for amateur work is the necessity for precise cut-and-try adjustment of the antennas, reflectors (if any) and the feeder system. While it is possible to compute the dimensions of the simple antenna with a fair order of accuracy, such computations are rarely adequate in the more complex arrays because of unpredictable "proximity" effects peculiar to any one set-up and location.

### Phased Antennas

● By combining a number of half-wave antennas in various space relationships and exciting them in the proper phase, it is possible to concentrate the radiation in one or more desired directions. One of the simplest types of array involving this principle consists of two half-wave antennas stacked one above the

other and excited in phase. The result is a system which radiates equally well in all directions in a horizontal plane but which tends to concentrate the radiation at some particular angle in the vertical plane. At the high frequencies, where it is possible to support the lower half-wave section well clear of the ground, the main "lobe" of radiation is usually at a low angle — a condition considered to be very favorable under the circumstances.

The same type of array can be carried further on the ultra-high frequency bands by using as many as five or six half-wave an-

tennas one above the other and all operating in phase. With such a system, the directivity at a low angle to the horizon is very marked and a considerable gain in the range of the station is made possible. One simple method of maintaining the correct phase relationship in the antennas is that shown in Fig. 1632 at "C." A quarter-wave section is inserted at the junctions between each pair of antennas. These sections, in the actual array, may be mounted on small wooden cross-pieces of the mast itself. An alternative method is to include a coil-condenser tuned circuit in place of the quarter-wave sections. These tuned circuits may be built up with a small coil and midget variable condenser mounted on the metal lid of a small glass jar. The circuits may be tuned by the absorption method to the transmitter frequency and then connected into the antenna system.

### Horizontal Directivity

● When half-wave antennas are mounted side by side and excited correctly, the radiation is concentrated in two directions in a horizontal plane. The simplest form of "broadside"

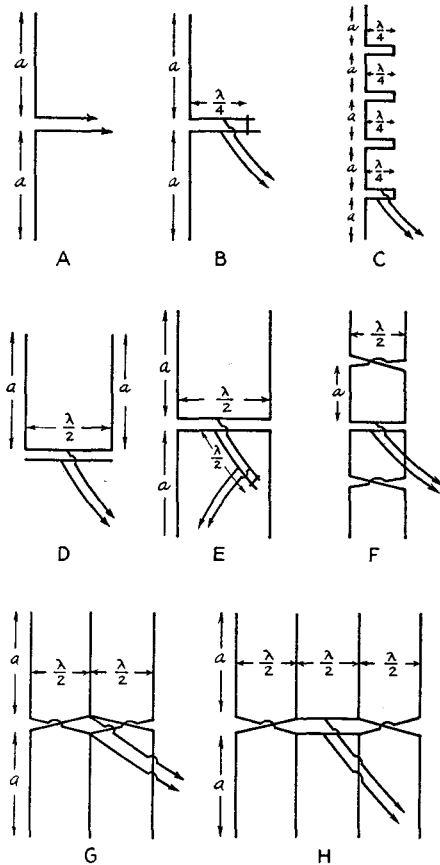

FIG. 1632 — A VARIETY OF DIRECTIVE ARRAYS INVOLVING THE USE OF PHASED ANTENNAS

Most of the types illustrated are suited particularly for the ultra-high frequencies. Types "A" and "D" are small enough to fit the average available space on 14 mc. The more complex arrays are usually too extensive except on 56 mc. and higher. Tuned feeders are shown on some types — matching sections and untuned lines on others. Obviously, the feed systems are interchangeable. See text for details of tuned feeders.

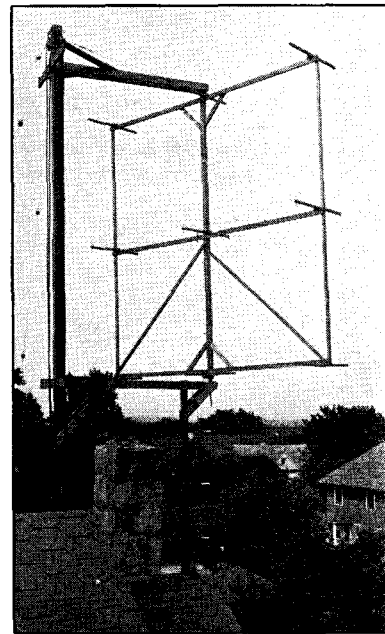

FIG. 1633 — THE 112-MC. ARRAY AT W2CUZ: AN EXCELLENT EXAMPLE OF CONSTRUCTION TO ALLOW ROTATION OF THE SYSTEM

The electrical arrangement of the antennas is that shown at "G" of Fig. 1632. Reflectors are mounted one quarter wave behind each of the antennas.

antenna is that shown at "D" of Fig. 1632. The two antennas are a half wave apart and are excited in phase. Radiation is then concentrated in the directions at right angles to the plane of the antenna wires. The scheme can be carried further by providing four or more similarly phased antennas.

### Array of Arrays

● On the ultra-high frequencies in particular, it is very desirable to use a combination of the vertical or "stacked" array and the broadside array, so obtaining directivity in both horizontal and vertical planes. The system shown at "E" in Fig. 1632 consists of a "broad-sided" pair of array elements each consisting of two "stacked" half-wave antennas. Two variations of the same idea are shown at "F" and "H." In the former case, a number of two-element broadside sections are stacked vertically to give slight directivity in a horizontal plane but considerable vertical directivity. In the latter case, the horizontal directivity is accentuated. Both arrangements are particularly suited for ultra-high frequency working where the small length of the antenna elements permits eight or more of them to be used.

### Feeding the Array

● The simplest method of feeding any of these arrays in practice is with a tuned feeder connected at some appropriate point. The simple rule to remember, in deciding on the point of attachment, is that an odd number of quarter waves will be required in the main feeder when it connects to the ends of antenna elements (as at "A" and "G" in Fig. 1632); and that an even number of quarter waves will be required when the feeders are connected in the center of one antenna element or in the center of any half-wave secondary feeder (as at "D" or "H." The same

considerations apply to a tuned matching section which may be used in conjunction with an untuned line. At "B" the matching section is one quarter wave. At "E" it will need to be two quarter waves.

The array shown at "H" is relatively simple to feed since the impedance presented by the system is approximately 600 ohms. A 600-ohm line may merely be used in place of the tuned line to get reasonably good performance. The impedance of arrays of this particular type may be computed by dividing the end impedance of a half-wave antenna (about 2300 ohms) by the number of pairs of half-waves employed.

### Using Reflectors

● When a wire of appropriate length is placed an appropriate distance behind any simple antenna, the wire will function as a reflector and increase the intensity of the radiation forward from the antenna. Usually such a reflector wire may be slightly longer than the half-wave antenna with which it is used and spaced one quarter wave behind the antenna.

Should the antenna and reflector be well in the clear, it is usually safe to make the reflector about 2 per cent longer than the antenna. Trees and buildings in the vicinity of the system are likely to demand considerable departures from this figure and in one very effective installation of this type (described by H. E. Smith in *QST*, May, 1935) the reflector wire, as the result of careful measurement, had to be made shorter than the antenna.

Such reflector wires may be used in conjunction with arrays of antennas to provide unidirectional transmission and added power gain. The reflector elements are strung together as a replica of the antenna array (but without any interconnecting feeders) and then mounted one quarter wave behind the antenna assembly. Unidirectional arrays

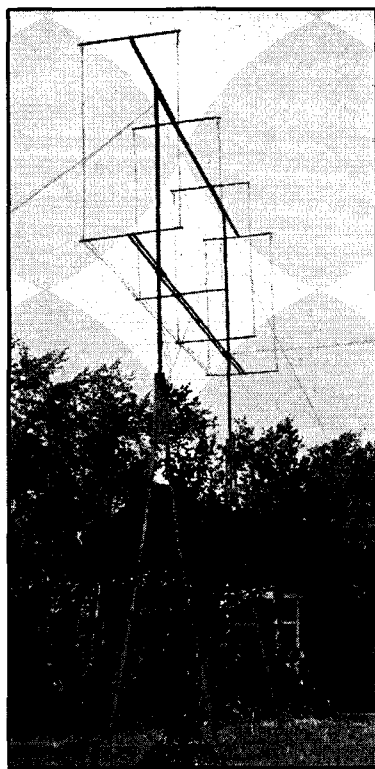

FIG. 1634 — A TYPICAL RIGID MOUNTING FOR THE ULTRA-HIGH FREQUENCY DIRECTIVE ARRAY

The array shown is similar to that of "H" in Fig. 1632 except that only the upper four antennas are used. Reflectors are mounted behind each antenna wire. Some such rigid mounting is very desirable for u.h.f. work. This particular array is used at W1HRX.

of this type are widely used on the ultra-high frequencies where the small size of the array permits it to be mounted on a simple structure capable of rotation.

### Using Directors

● Still greater improvement in the directivity of this type of array may be had by using director wires in front of the antenna elements. Practice indicates that these wires should be mounted approximately three-eighths of a wavelength in front of the antenna elements and that the wires should be approximately 87 percent of a half-wave long. Here again, the optimum dimension and spacing can be determined in individual locations only by a careful cut and try procedure.

### Long-Wire Arrays

● As has already been explained, the long-wire antennas have definite directivity characteristics. Two long-wire antennas may be com-

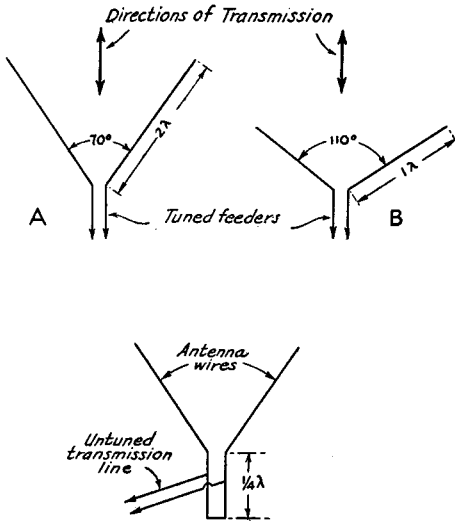

FIG. 1635—ILLUSTRATING THE MODEL D OR "V" TYPE LONG-WIRE ARRAY

The array consists primarily of two long antennas some multiple of a wavelength long and arranged in "V" form. The angle between the wires depends on their length. Angles for antennas longer than those shown are: 3 wavelengths—60 degrees; 4 waves—52 degrees; 5 waves—45 degrees; 6 waves—40 degrees; 7 waves—38 degrees; 8 waves—35 degrees. These figures are approximate only and in practice will be influenced by any trees or buildings near the wires. The system may be fed with a tuned line an odd number of quarter waves long, or with a quarter-wave matching section and untuned line. This array is horizontally polarized and is therefore unsuited for u.h.f. communication with stations using vertical antennas. (See text.)

ined to give pronounced directivity in one or two directions only. This type of array has the advantage of requiring a simple supporting structure but even on the ultra-high frequencies a large tract of land is required if a high order of directivity is to be had.

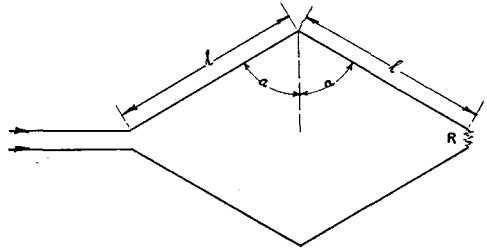

FIG. 1636—THE GENERAL ARRANGEMENT OF THE "DIAMOND" OR "RHOMBIC" DIRECTIVE ARRAY

The angle "a" between the antenna elements and the transverse axis of the system depends on the length of the antenna elements. The following approximate figures should be observed:

"l" in wavelengths	"a" in degrees
1	30
2	50
3	57
4	62
5	65
6	67
7	68
8	69

The system is bidirectional without the resistor R. With the resistor in place and correctly adjusted, the array is unidirectional—transmitting in the direction away from the feeder end toward R. Like the "V," this array, in its conventional form, is horizontally polarized.

In the "V" type, the system consists of two wires separated by an angle determined by the number of wavelengths on each wire. Since the antennas are being excited at a voltage loop, an ordinary tuned line an odd number of quarter-waves long may be used as the feeder. Alternatively, a tuned quarter-wave section may be provided to enable an untuned line to be "matched in."

The "Rhombic" type of antenna array contains four antennal elements arranged in "diamond" form—the angles between the wires again being related to the length of the antenna elements. This type of array may either be operated with the far end open—in which case it is bidirective—or with a non-inductive resistor of about 800 ohms across the far end. In this case, the system is non-resonant and unidirectional. It may be operated with little variation in performance over a 2 to 1 range of frequencies.

Both of these long-wire arrays become highly effective when their length is of the

order of three to eight wavelengths but in this case a relatively enormous space is required even for 14 mc. operation. On the 56-mc. band, the dimensions become more nearly reasonable but unfortunately the arrays radiate horizontally polarized waves and are therefore unsuited for use in communication with stations using vertical antennas. Since almost all amateur u.h.f. stations today use vertical antennas, the long wire arrays have found little use. This particular point will be given further consideration later.

### Antenna Systems for the Ultra-High Frequencies

● The problem of designing an antenna for the ultra-high frequencies is in no respect different to that faced on the lower frequencies. Antenna lengths are determined in the same fashion, tuned feeders remain some multiple of a quarter wave and matching systems are treated in the same manner. The u.h.f. antennas are, of course, much smaller than their low frequency counterparts and it is therefore more readily possible to observe their performance with a neon bulb or galvanometer. Their small size also permits the erection of arrays of antennas even in space which would be considered restricted for lower frequency working.

Obviously, an intelligent approach to the antenna problem requires a knowledge of fundamental principles. To the ultra-high frequency worker we would suggest thorough study of this entire chapter in addition to latter portions, in particular, of Chapter Four.

### The Simple Systems

● For some experimental work and portable u.h.f. operation it is often desirable to use the simplest possible form of antenna. In such cases, a half-wave element with tuned feeders connected at the bottom is one very satisfactory arrangement. Alternatively some of the special 75-ohm feeder or even common twisted pair may be connected in the center of the half-wave element. With the superregenerative receiver it is particularly important that the antenna and feeder be tuned or, in the case of the untuned feeder, that the coupling to the grid coil of the receiver be very carefully adjusted. Untuned receiving antennas of the type commonly used on the lower frequencies are disappointing on the ultra-high frequencies.

The same type of simple antenna with any of the feed systems described earlier in this chapter may be used for transmitting. However, the advantages to be had by using even

a simple array are such that the day of plain antennas is rapidly passing.

### Construction of Arrays

● Any of the arrays shown in Fig. 1632 are thoroughly suited for ultra-high frequency operation. Systems such as those shown at "A" and "B" can be erected simply by hauling them into position on the pole available. Arrays of the type shown at "D" to "H" can usually be suspended from a rope between two supports. The most satisfactory structures, though, are rigid types either rotatable (shown in Fig. 1633) or fixed (Fig. 1634). On 56 mc., a rotatable array giving appreciable gain is a large affair, difficult and expensive to build. On 112 mc. the structure becomes much simpler. The example of an array of six half-wave antennas and six reflectors shown in Fig. 1633 is an excellent model to follow.

### Vertical vs. Horizontal Antennas

● It has become general practice in amateur u.h.f. work to use vertical antennas exclusively. This is probably the result of early experimental work, which showed the vertical antenna to outperform the horizontal antenna in transmission over short direct paths. The trend of today, however, is toward further investigation into the merits of horizontal antennas for u.h.f. work. The horizontally polarized waves transmitted from such antennas have been shown, in recent experiment, to provide better signals over long indirect paths than vertically polarized waves. Any of the arrays described may be made to radiate horizontally polarized waves merely by suspending them with the antenna elements horizontal.

It should be pointed out that the horizontal antenna on the ultra-high frequencies will perform very poorly in transmitting to or receiving from a station using a vertical antenna.

### Long Wire Antennas for the Ultra-Ultra Highs

● Undoubtedly the most effective and certainly the simplest arrays of all are the "V" and "Diamond" or "Rhombic." In their conventional form, these both transmit horizontally polarized waves and have therefore been considered in amateur circles to be unsuited for u.h.f. work. It seems certain, however, that the next year or two will see them in wide use — particularly for the 112- and 224-mc. bands. The dimensions of these systems are, in terms of wavelengths, exactly the same as when operated on the lower frequencies.

# 17

## *Instruments and Measurements*

### **MONITORS—FREQUENCY METERS—VOLTMETERS AND MILLIAMMETERS—OHMMETERS—TEST OS- CILLATORS—V. T. VOLTMETERS—FIELD STRENGTH METERS—CATHODE-RAY OSCILLOSCOPES**

**T**HE proper operation of all but the very simplest of transmitters and receivers calls for the use of a certain number of instruments of various types. These range from ordinary meters for the measurement of d.c. voltage and current to frequency-meter monitors for aurally checking the frequency and quality of the transmitted signal and cathode-ray oscilloscopes for the visual inspection of the signal. In addition, various instruments such as ohmmeters, oscillators and vacuum-tube voltmeters are of great utility for tracing down sources of trouble in receivers and transmitters and for many types of measurements in experimental work. While the amateur station can be operated successfully with nothing more than a means for checking transmitter plate current and frequency — and for proper modulation, in the case of a 'phone transmitter — the progressive amateur is interested in instruments and measurements as an aid to better performance. The measure of the perfection of an amateur station, once a satisfactory transmitter and receiver have been provided, is the extent and utility of the auxiliary measuring and checking apparatus provided.

#### **Monitors for C. W.**

● Aside from current-indicating instruments, which must be purchased, one of the most useful instruments the station can have is a

monitor, used for checking the quality of the emitted signal.

A monitor is a miniature receiver, usually having only a single tube, enclosed with its batteries in some sort of metal box which acts as a shield. It need not be a costly or elaborate affair. The example shown in Fig. 1702 illustrates the simplicity of a typical monitor.

The requirements for a satisfactory monitor for checking c.w. signals are not difficult to satisfy. It should oscillate steadily over the bands on which the station is to be active; the tuning should not be excessively critical, although the degree of band-spreading ordinarily considered desirable for receivers is not essential; the shielding should be complete enough to permit the monitor to be set near the transmitter and still give a good beat note when tuned to the fundamental frequency of the transmitter (this is often impossible with

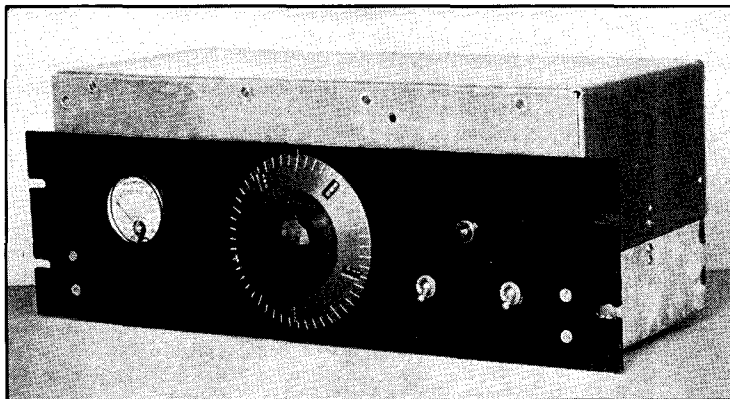

**FIG. 1701 — A COMBINATION HETERODYNE FREQUENCY METER AND MONITOR**

*A.c.-operated, with self-contained power supply, this unit features relay-rack construction in the modern trend.*



## . . . . . Instruments and Measurements

the receiver because the pick-up is so great); and it should be constructed solidly enough so that it can be moved around the station without the necessity for retuning when listening to a fixed signal.

Almost any sort of metal can or box can be used as a shield for the monitor. The can shown in Fig. 1702 is an ordinary six-inch cracker tin given a coat of black lacquer. The circuit diagram, given in Fig. 1703, uses a Type 30 tube in a simple oscillating circuit.

All parts except the "A" and "B" batteries are mounted on the under side of the lid. The "A" battery is a single 1.5-volt dry cell of the type used in tubular flashlights, the "B" battery a small-size 22½-volt block. These two batteries are taped together and connected to the monitor proper with rubber-covered leads, also taped together to keep them from vibrating after the monitor has been assembled. Wadded paper may be packed around the batteries when they are placed in the bottom of the container so that they will not move when the monitor is carried around.

### Checking the Transmitter Frequency

● In the absence of more elaborate frequency-measuring equipment, a monitor is useful in the highly-important operation of setting the frequency of a self-excited transmitter within an amateur band. To do this it is necessary to calibrate the receiver dial settings in terms of frequency, or at least to know to a fair approximation where the limits of the band lie on the

dial. A quite accurate idea of band limits can be obtained by listening to other amateur stations, noting where amateur activity stops at each end of the band. The receiver also may be checked against A.R.R.L. Standard Frequency Transmissions, schedules for which appear regularly in *QST*.

After the band limits have been determined a suitable working spot should be picked within the band and the receiver left running at that setting. The monitor then should be put into operation. If an extra pair of 'phones is not available a bent piece of bare No. 14 wire may be plugged into the 'phone tip jacks of the monitor so that its plate circuit will be closed. Tune the monitor condenser slowly across the band, stopping when the signal from it is heard in the receiver. The monitor will now be set exactly on the frequency to which the transmitter is to be tuned. If no signal is heard, check the monitor to make sure it is oscillating, move it closer to the receiver, or open the lid so that the shielding will not be so great. Make certain that the right coil is in the monitor.

With the monitor setting determined, transfer the headset from the receiver to the monitor, start up the transmitter, and tune carefully until a signal from the transmitter is heard in the monitor. Set the transmitter frequency to "zero beat" — the silent space between the two beat notes — and the transmitter frequency will be exactly on the spot picked out. The frequency upon which the transmitter is set should be well inside the limits of the band so there will be no possibility of off-frequency operation.

### Absorption Frequency Meters

● The simplest type of frequency meter consists of a coil and condenser, tunable over the frequency range desired. A frequency meter of this type, when tuned to the frequency of the transmitter and loosely coupled to the tank coil, will extract a small amount of energy from the tank. The energy thus extracted can be used to light a small flash-light lamp, connected as shown in Fig. 1704. Maximum current will flow in the lamp when the frequency meter is tuned exactly to the transmitter fre-

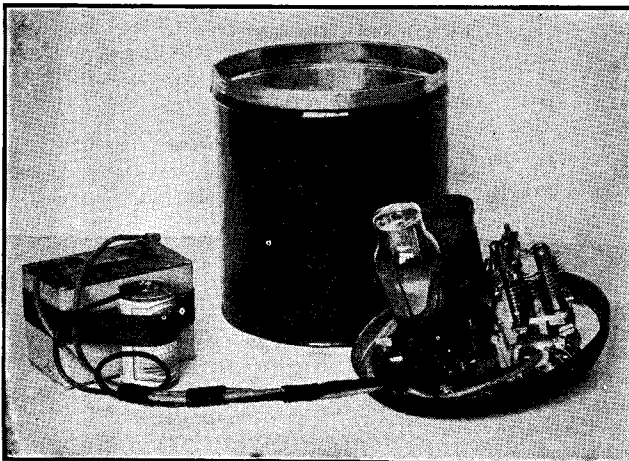

FIG. 1702 — AN INEXPENSIVE MONITOR BUILT IN A CRACKER TIN  
The simple construction shown above is typical. The monitor, despite its simplicity and low cost, is an extremely useful piece of station equipment.

# The Radio Amateur's Handbook . . . . .

quency, hence the brightness of the lamp indicates resonance. A more accurate indication may be obtained by substitution of a thermogalvanometer for the lamp. Although this type of frequency meter is not well adapted to

wire, no spacing between turns except for the high-frequency coil, in which the two turns are spaced  $\frac{1}{2}$ -inch.

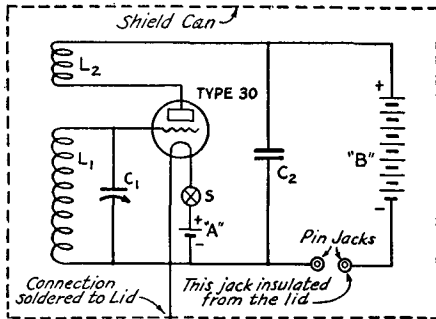

FIG. 1703 — WIRING DIAGRAM OF THE MONITOR

The circuit components have the following values:  
*C*<sub>1</sub> — 50- $\mu$ fd. (.00005  $\mu$ fd.) midget variable condenser.  
*C*<sub>2</sub> — .002- $\mu$ fd. fixed condenser.  
*S* — Single-pole toggle switch.

Other materials required include two 4-prong tube sockets, a Type 30 Tube, a pair of 'phone-tip jacks, a small-size 22½-volt "B" battery (Eveready No. 763 or equivalent), and a single-cell 1.5-volt flash-light battery. Two or even three of these cells can be connected in parallel for longer life.

The coil forms are 1½ inches in diameter. All coils are wound with No. 30 d.s.c. wire.

The coils *L*<sub>1</sub> and *L*<sub>2</sub> are wound on the same plug-in coil form (4 prong) and are wound in the same direction, *L*<sub>1</sub> at the upper end of the form. The upper terminal of *L*<sub>1</sub> connects to the grid of the tube, the lower terminal to the filament of the tube; the terminal of *L*<sub>2</sub> nearest *L*<sub>1</sub> goes to the positive side of the "B" battery and the remaining terminal to the plate of the tube. The arrangement of the pins on the form may be anything convenient.

Band	<i>L</i> <sub>1</sub>	<i>L</i> <sub>2</sub>
1750 kc.	70	20
3500 kc.	35	10
7000 kc.	15	6
14,000 kc.	5	4

precise measurement of frequency, it is useful in a variety of ways.

To make the absorption meter most useful, a series of coils should be provided so that it will cover a continuous frequency range from about 1500 kc. up to the highest frequency likely to be needed — probably up through the amateur five-meter band, or to 60,000 kc. A rather large condenser should be used; a variable with about 350- $\mu$ fd. maximum capacity will be satisfactory. Coils to cover the range with a condenser of this size may be made as shown in the table below. The frequency ranges are approximate only; adequate overlap is provided. The specifications are for coils wound on a two-inch form with No. 20 d.c.c.

Range	Turns
1500-5000 kc.	25
3000-10,000 kc.	10
6000-20,000 kc.	5
18,000-60,000 kc.	2 (spaced)

Calibration of the absorption frequency meter calls for a receiver of the regenerative type to which the coil in the meter can be coupled. With the detector oscillating weakly, the frequency meter should be brought near the detector coil and tuned over its range until a setting is found which causes the detector to stop oscillating. The coupling between meter and receiver should then be loosened until the stoppage of oscillations occurs at only one spot on the meter tuning dial. The meter is then tuned to the frequency at which the receiver is set. If the receiver is set on several stations of known frequency, a number of points for a calibration curve can be obtained for each frequency-meter coil.

The absorption frequency meter is particularly useful for checking the tuning of a transmitter stage (to ensure that the stage is not tuned to a harmonic instead of the desired frequency, for instance), for determining the frequency of parasitic oscillations in the transmitter, for finding the frequency range covered by regenerative receiver coils, etc.

For transmitter work, a flash-light lamp or other resonance indicator is not at all necessary, since resonance will be indicated by a flicker in plate current of the stage being checked as the meter is tuned through resonance.

## Heterodyne Frequency Meters

● The heterodyne frequency meter somewhat resembles the monitor in that it is a small os-

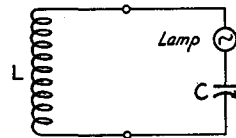

FIG. 1704 — ABSORPTION FREQUENCY METER CIRCUIT

The variable condenser, *C*, should have a maximum capacity of about 350  $\mu$ fd. The meter should be arranged so that the coils are readily interchangeable. The lamp acts as a resonance indicator when the absorption meter is used with a transmitter; its use is not essential, although it is a convenience. Coil specifications are given in the text.

## . . . . . Instruments and Measurements

illator, completely shielded, but the refinement and care in construction is carried to a high degree so that the frequency meter can be accurately calibrated and will retain its calibration over long periods of time. The oscillator used in the frequency meter must be very stable; that is, the frequency of oscillation at a given dial setting must be practically the same under any conditions. No plug-in coils are used in the frequency-meter; one solidly built and firmly mounted coil is permanently installed in it, and the oscillator covers one band only. A low-frequency band is used for this purpose, and when the meter is to be used on the higher-frequency bands its harmonics instead of the fundamental oscillation are used.

The frequency meter must possess a dial which can be read precisely to fractions of divisions. To obtain accuracy it is necessary to read the scale to at least one part in 500; ordinary dials such as are used for receivers are not capable of such precision. The National 4" Type N and 6" Type N and NW dials are provided with vernier scales for reading to a tenth of a scale division (one part in 1000) and are well suited to this work, as is also the type

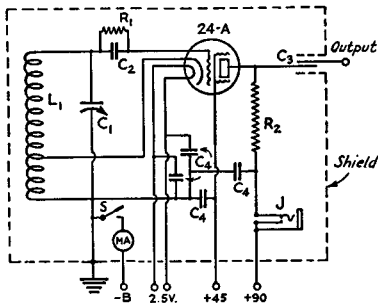

FIG. 1705 — CIRCUIT OF THE ELECTRON-COUPLED FREQUENCY METER

This circuit is for use with indirectly heated tubes such as the 24-A and 36. If pentode-type tubes are used the suppressor should be connected to ground, not to cathode.

$C_1$  — Band-spread condenser, minimum capacity 53  $\mu\text{f.d.}$ , maximum capacity, 81  $\mu\text{f.d.}$ , approximately. (Such as General Radio Type 556 or National Type 40-75.)

$C_2$  — 250- $\mu\text{f.d.}$  mica condenser.

$C_3$  — Approximately 10  $\mu\text{f.d.}$ . See text for details.

$C_4$  — .01- $\mu\text{f.d.}$  mica by-pass condenser.

$R_1$  — 100,000-ohm grid leak.

$R_2$  — 50,000-ohm 1-watt resistor, pigtail type, non-inductive.

J — Close-circuit 'phone jack.

S — On-off switch, s.p.s.t.

$L_1$  — Approximately 90 turns of No. 30 d.s.c. wire close-wound on a 1-inch bakelite tube, tapped at the 30th turn from the grounded end. A few more or less turns may be needed to spread the 1750-kc. band over the dial scale to the best advantage.

P.W. The General Radio 704 and 706 series dials also are excellent. There are a few other good dials on the market. Care should be used to select one which has fine lines for division marks, and which has an indicator very close to the dial scale so that the readings will not be different when the dial is viewed from different angles.

The heterodyne frequency meter also can be used as a monitor if desired.

### The Electron-Coupled Frequency Meter

● One of the most stable oscillator circuits, and therefore most suitable for the frequency

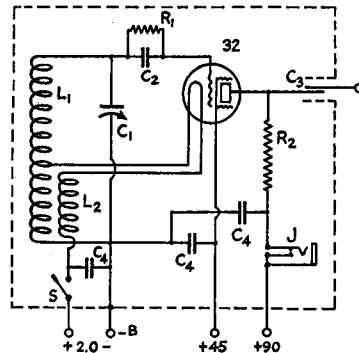

FIG. 1706 — ELECTRON-COUPLED FREQUENCY METER CIRCUIT FOR USE WITH DIRECTLY-HEATED TUBES SUCH AS THE 32 OR 1B4

The circuit is essentially the same as that of Fig. 1705 except that both sides of the filament must be fed through coils to prevent grounding the filament.  $L_1$  has the same specifications.  $L_2$  has the same number of turns as the tapped portion of  $L_1$ . It may be wound over the corresponding part of  $L_1$  or directly on the coil form between the turns of the tapped portion of  $L_1$ . The other components have the same values as in Fig. 1705. In this circuit the filament switch as well as the output binding post and 'phone jack must be insulated from the shield.

meter, is the electron-coupled circuit. The oscillation frequency is practically independent of moderate variations in supply voltages, provided the plate and screen voltages applied to the screen-grid tube used are properly proportioned. Furthermore, because of the nature of the circuit it is possible to take output from the plate with but negligible effect on the frequency of the oscillator. A third feature is that strong harmonics are generated in its plate circuit so that the meter is useful over an extremely wide range of frequencies.

Circuit diagrams for electron-coupled frequency meters are given in Figs. 1705 and 1706. The former is for use with tubes having indirectly-heated cathodes; the latter for filament-type tubes. With directly-heated tubes

it is necessary to provide an extra winding,  $L_2$ , in series with one leg of the filament so that both filament terminals will be at the same r.f. potential.

Mechanical considerations are most important in the construction of a frequency meter. No matter how good the instrument may be electrically, its accuracy cannot be depended upon if it is flimsily built. Mount everything solidly; make connections with stiff wire and place all leads so they cannot be moved in the course of ordinary handling.

It is desirable to design the frequency meter so that the oscillator operates in the 1715-2000-kc. band, with a "spread" such that almost the entire dial scale is used to cover the band. While the specifications for the oscillator inductance under Fig. 1705 will be found to work out closely, it may be necessary to add or subtract a few turns to get the band-spread just right. For the higher-frequency bands harmonics of the oscillator are used. Thus the second harmonic will cover the 3500-4000-kc. band, the fourth the 7000-7300-kc. band over part of the scale, and so on to the highest frequencies used by amateurs. Strong harmonics can be taken from the frequency meter even on the 56,000-kc. band.

The output coupling condenser,  $C_3$ , in Figs. 1705 and 1706 should have very small capacity — about 10 to 15 micromicrofarads. A midget variable condenser will do — both sides must be insulated from the shield — or a small trimmer condenser can be used. Alternatively, a suitable condenser can be made from two pieces of metal strip measuring approximately one-half by one inch, arranged to face each other with a space of about  $\frac{1}{8}$  inch between their surfaces.

The signal from the frequency meter can be fed into the receiver by connecting a wire from the output post on the meter to the antenna post on the receiver. If the signal should be too loud, the wire from the output post can be disconnected from the receiver but left in the vicinity of the receiving lead-in.

The frequency-meter can be used as a monitor by plugging a pair of headphones in the jack,  $J$ , in the screen circuit.

When the frequency meter is first turned on some little time is required for the tube to reach its final operating temperature; during this period the frequency of oscillation will drift slightly. Although the drift will not amount to more than two or three kilocycles on the 3500-kc. band and proportionate amounts on the other bands, it is desirable to allow the frequency meter to "warm up" for about a half hour before calibrating, or before making measurements in which the utmost accuracy is desired. The on-off switch in Fig. 1705 is a useful adjunct to the meter because the "B" supply can be cut off independently of the filament supply, permitting the operator to keep the frequency meter up to temperature without wasting "B" current when no measurements are being made.

With careful construction, a good readable dial, and an accurate calibration made as described in a later section, measurements made with the electron-coupled frequency meter can be depended upon to be accurate to within 1 part in 1000, or one-tenth of 1 per cent., an accuracy more than sufficient for amateur work.

### A Combined Frequency Meter-Monitor

● Although an electron-coupled frequency meter constructed according to Figs. 1705 or 1706 can be used as a monitor as explained in

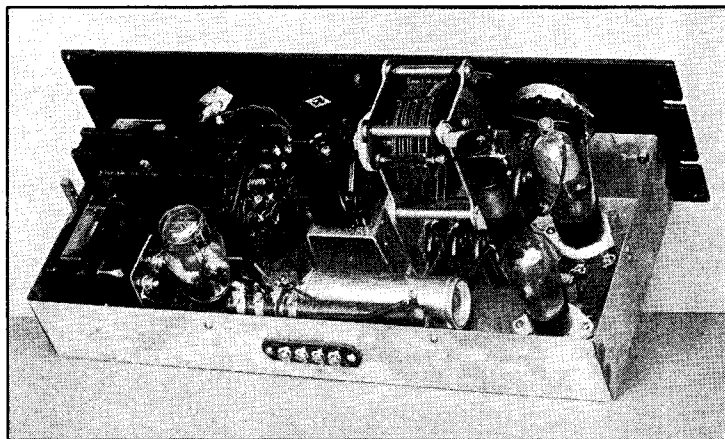

**FIG. 1707 — THE A.C.-OPERATED FREQUENCY METER IS ASSEMBLED WITH CONVENIENCE IN WIRING RATHER THAN APPEARANCE AS THE OBJECTIVE**

*A standard-size metal chassis, 17 x 7 x 2½ inches, inverted, holds the parts. The cover, made of aluminum, is 4½-inches high. The 5¼-inch standard front panel holds the PW dial, space-current meter, and on-off switches; overhang from an upper panel covers the remaining height of the unit.*

## . . . . . Instruments and Measurements

the previous section, the monitoring function will be performed more satisfactorily if a separate detector tube is added to the unit. Installation of the extra tube will give a stronger signal for monitoring purposes.

A combined frequency meter-monitor of this type is illustrated in Figs. 1707-1708. The circuit diagram of the oscillator is similar to that of Fig. 1705 up to the "output" terminals, where condenser  $C_3$  replaces  $C_3$ . The oscillator output is fed into the grid circuit of a Type 56 tube connected as a plate detector. This tube operates both as an amplifier of the radio-frequency output of the oscillator and as a detector when the oscillator output or one of its harmonics is made to beat with the signal from the transmitter.

A milliammeter reads the space (screen-grid and plate) current; if this is kept constant, and the heater voltage does not vary, the accuracy of the instrument will be high. One on-off switch turns the entire meter off and on; the other disconnects the screen voltage, to kill the

signal when the meter is being used as a monitor and it is desired to receive a signal on or near the transmitter frequency, thus keeping the meter warmed-up and stable.

### Calibrating the Frequency Meter

● When the frequency meter is finished it must be calibrated before it can be put into service. First its tuning range should be checked to be certain that it covers the 1750-ke. band with a little overlap at each end. This can be done by checking against a receiver covering the 1715-2000 or 3500-4000 ke. bands, picking up the frequency-meter signal on the receiver.

After the coverage has been checked, the current issue of *QST* should be consulted for information as to the next transmission of standard frequencies for calibration purposes. These transmissions are given once or twice each week by the stations comprising the A.R.R.L. Standard Frequency System, located in different geographical sections of the United States. Each of the stations is equipped with a

frequency standard which is accurate to better than one part in 10,000 or .01 per cent. These individual standards have been calibrated directly against the national frequency standard located in the laboratory of the Bureau of Standards at Washington, and the calibration signals transmitted for amateurs are therefore based on the national frequency standard. The transmissions consist of signals which mark accurately the limits of the 3500-, 7000-, and 14,000-ke. bands with intermediate points at 100 ke. intervals.

The procedure is to tune in the standard frequency station on the receiver with the detector oscillating, then back off the regeneration control until the detector stops oscillating but is still giving a great deal of regenerative amplification. With a superhet receiver the signal would first be tuned in with the beat oscillator on; after setting the receiver to zero beat with the incoming signal the beat oscillator should be shut off. The dial on the frequency meter should then be turned until the signal from the meter is heard to beat with the standard frequency signal. Adjust the frequency meter to give zero beat and note the dial reading. A number of these points will give a complete calibration and make possible the drawing of a curve on graph paper.

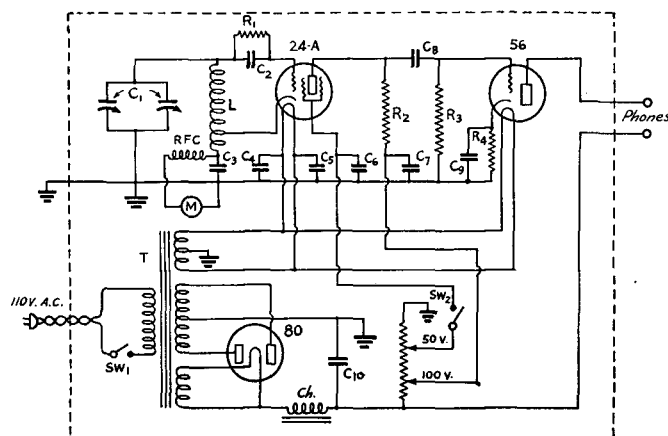

FIG. 1708 — CIRCUIT DIAGRAM OF THE A.C.-OPERATED FREQUENCY METER

- $C_1$  — Two-section band-spread condenser (General Radio 556).
- $C_2$  — 250- $\mu$ fd. fixed mica condenser.
- $C_3, C_7$  — .006- $\mu$ fd. fixed mica condensers.
- $C_8$  — 40- $\mu$ fd. fixed mica condenser.
- $C_9$  — .25- $\mu$ fd. tubular paper condenser.
- $C_{10}$  — 8- $\mu$ fd. 450-volt electrolytic filter condenser.
- $R_1$  — 100,000-ohm  $\frac{1}{2}$ -watt fixed resistor.
- $R_2$  — 100,000-ohm 1-watt fixed resistor.
- $R_3$  — 1-megohm  $\frac{1}{2}$ -watt fixed resistor.
- $R_4$  — 100,000-ohm  $\frac{1}{2}$ -watt fixed resistor.
- $R_5$  — 10,000-ohm 25-watt semi-variable resistor.
- $L$  — 33 turns No. 30 d.s.c. close-wound on 1-inch diameter bakelite tube, cathode tap 31 turns from ground end.
- $T$  — 275-volt 40-ma. plate transformer, with 5-volt 2-amp. and 2.5-volt 3-amp. filament windings.
- $Ch$  — 30-henry 40-ma. filter choke.
- $MA$  — 0.5 milliamperes.

# The Radio Amateur's Handbook . . . . .

Caution must be employed when using a heterodyne frequency meter in conjunction with a superheterodyne receiver, since signals may be heard on at least two spots on the re-

will actuate the microphone and cause the audio amplifier to break into a howl.

### D.C. Instruments

● Throughout this *Handbook* reference has been made to the use of direct-current instruments for measurement of current and voltage. Voltmeters and milliammeters are basically identical instruments, the difference being in the method of connection. A voltmeter measures the current through a high resistance connected across the source to be measured; its calibration is in terms of voltage drop in the resistance, or *multiplier*. A milliammeter is connected in series with the circuit and meas-

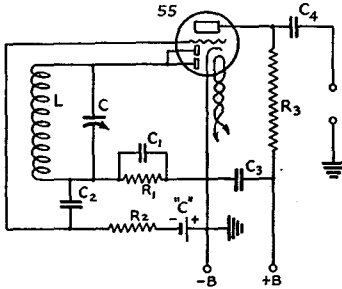

FIG. 1709 — SIMPLE 'PHONE MONITOR USING A TYPE 55, 85 OR 6R7 TUBE

- $C_1 - 250 \mu\text{fd.}$
- $C_2 - .01 \mu\text{fd.}$
- $C_3 - .002 \mu\text{fd.}$
- $C_4 - 1 \mu\text{fd.}$
- $R_1 - .5 \text{ megohm.}$
- $R_2 - 2 \text{ megohms.}$
- $R_3 - .1 \text{ megohm.}$

ceiver dial; one is where the meter-frequency equals the receiver frequency, the other where the meter-frequency equals that of the h.f. oscillator in the receiver. Sometimes an image frequency is also received. To check, detune the receiver slightly from zero beat (with the b.f.o. turned off). If the meter is not on the signal frequency a varying audio note will be heard; if it is correctly located, tuning the receiver slightly will cause no change in the beat note.

### Listening Monitors for 'Phone

● Any type of simple detector circuit with a means for picking up a small amount of r.f. from the transmitter can be used as a 'phone monitor. The pickup coil need not even be tuned, although the monitor will be considerably more sensitive when tuned to the transmitter frequency.

A satisfactory type of 'phone monitor, using a Type 55 tube as a diode detector and audio amplifier, is shown in Fig. 1709. The circuit LC is tuned to the transmitter frequency; any constants which satisfy this requirement can be used. A headset can be connected to the output posts in series with  $C_4$  and ground.

Because of the tuned pickup and audio amplification a monitor of this type will be quite sensitive. Besides its primary use for audio quality checks, it can be used for checking the effect of transmitter adjustments on hum and other carrier noises.

The 'phone monitor usually must be used with a headset, since a loud-speaker

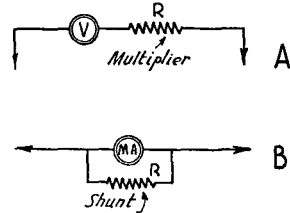

FIG. 1710 — HOW VOLTMETER MULTIPLIERS (A) AND MILLIAMMETER SHUNTS (B) ARE CONNECTED

ures the current flow. The ranges of both voltmeters and milliammeters can be extended by the use of external resistors, connected in series with the instrument in the case of a voltmeter, or in shunt in the case of a milliammeter. A low-range milliammeter also can be used as a voltmeter by connecting a resistor of suitable value in series.

The ways in which multipliers and shunts are connected to voltmeters and milliammeters are shown in Fig. 1710. To calculate the value of multiplier or shunt it is necessary to know

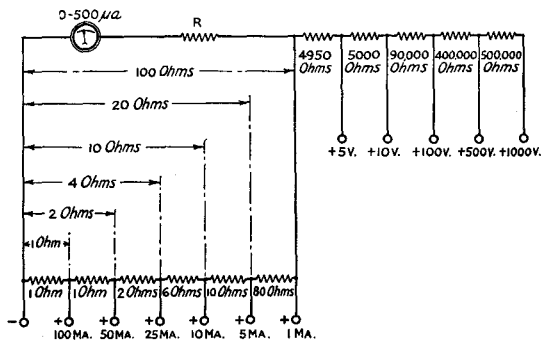
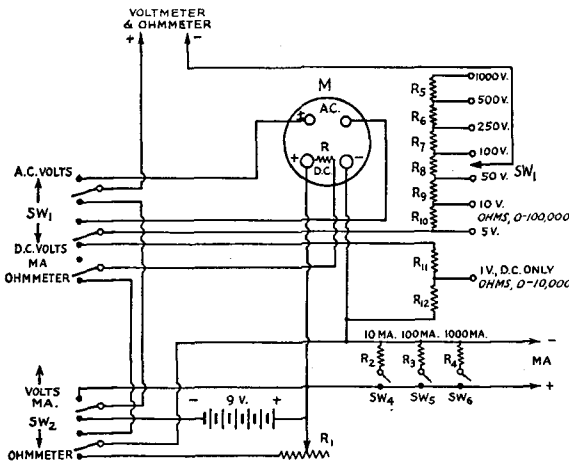

FIG. 1711 — A MULTI-RANGE VOLTMETER-MILLIAMMETER USING A 0-500 MICROAMMETER

The value of the resistance R is discussed in the text. (From the "Aerovox Research Worker.")



**FIG. 1712 — COMBINATION MULTI-RANGE OHM-METER, MILLIAMMETER AND A.C.-D.C. VOLTMETER**

*R* — shunt to compensate for resistance of rectifier (integral with meter when self-contained rectifier is employed).

*R*<sub>1</sub> — 650-ohm rheostat.

*R*<sub>2</sub> — 5-ohm precision fixed resistor (10-ma. shunt) if 50 mv. meter, comparable value for other meters.

*R*<sub>3</sub> — .5 ohm precision fixed resistor (100-ma. shunt).

*R*<sub>4</sub> — .05 ohm precision fixed resistor (1000-ma. shunt)

*R*<sub>5</sub> — 500,000-ohm precision fixed resistor.

*R*<sub>6</sub> — 250,000-ohm precision fixed resistor.

*R*<sub>7</sub> — 150,000-ohm precision fixed resistor.

*R*<sub>8</sub> — 50,000-ohm precision fixed resistor.

*R*<sub>9</sub> — 40,000-ohm precision fixed resistor.

*R*<sub>10</sub> — 5,000-ohm precision fixed resistor.

*R*<sub>11</sub> — 4,000-ohm precision fixed resistor.

*R*<sub>12</sub> — 950-ohm precision fixed resistor.

*SW*<sub>1</sub> — Triple-pole double-throw jack switch.

*SW*<sub>2</sub> — Double-pole double-throw jack switch.

*SW*<sub>3</sub> — 8-point rotary switch.

*SW*<sub>4</sub>, *SW*<sub>5</sub>, *SW*<sub>6</sub> — Single-pole single-throw toggle switches (see text).

*M* — 0-1 milliamperes (Weston Model 301 Universal meter).

the resistance of the meter; this information can be obtained from the maker. If it is desired to extend the range of a voltmeter, the value of resistance which must be added in series is given by the formula:

$$R = R_m (n - 1)$$

where *R* is the multiplier resistance, *R*<sub>*m*</sub> the resistance of the voltmeter, and *n* the scale multiplication factor. For example, if the range of a 10-volt voltmeter is to be extended to 1000 volts, *n* is equal to 1000/10, or 100.

If a milliammeter is to be used as a voltmeter, the value of series resistance can be found by Ohm's law, or

$$R = \frac{1000 E}{I}$$

where *E* is the desired full scale voltage and *I* the full-scale current reading of the instrument in milliamperes.

To increase the current range of a milliammeter, the resistance of the shunt, Fig. 1710-B, can be found from the formula:

$$R = \frac{R_m}{n - 1}$$

where the letters have the same significance as before.

## Multi-Range Voltmeters and Milliammeters

● A combination voltmeter-milliammeter having various ranges is extremely useful for experimental purposes and for trouble-shooting in receivers and transmitters. As a voltmeter such an instrument should have high resistance so that very little current will be drawn in making voltage measurements. A voltmeter taking considerable current will give inaccurate readings when connected across a high-resistance source, as is often the case in checking voltages at various parts of a receiver circuit. For such purposes a 1000-ohm s-per-volt instrument is customarily used; a 0-1 milliammeter or 0-500 microammeter (0-0.5 ma.) is the basis of most multi-range meters of this type.

The various current ranges on a multi-range instrument can be obtained by using a number of shunts individually switched in parallel with the meter. A better method, however, is shown in Fig. 1711. Resistors of the proper value are connected in series with the meter and the external circuit tapped across appropriate connections for the various ranges. Inaccuracies due to switch contact resistance are avoided. The values given are for use with a 0-500 microammeter. The resistance marked *R* should be 100 - *R*<sub>*m*</sub> ohms, where *R*<sub>*m*</sub> is again the resistance of the meter.

## Ohmmeters

● It is often necessary to check the value of a resistor or to find the value of an unknown resistance, particularly in receiver servicing. For this purpose an "ohmmeter" is used. An ohmmeter is simply a low-current d.c. voltmeter provided with a source of voltage (usually dry cells), connected in series with the unknown resistance. If a full-scale deflection of the meter is obtained with the connections to the external resistance shorted, insertion of the resistance under measurement will cause the reading to decrease in proportion to the amount of resistance inserted. The scale can therefore be cal-

# The Radio Amateur's Handbook . . . . .

ibrated in ohms. If a voltmeter not calibrated directly in resistance values is used, the following formula can be applied:

$$R = \frac{eR_m}{E} - R_m$$

where  $R$  is the resistance under measurement,  $E$  is the voltage read on the meter,  $e$  is the series voltage applied, and  $R_m$  is the internal resistance of the meter (full-scale reading in volts  $\times$  ohms-per-volt).

A combination ohmmeter, multi-range d.c. milliammeter, and multi-range a.c. and d.c. voltmeter is shown in Fig. 1712. As an ohmmeter it consists of a 0-1 ma. d.c. instrument, a 9-volt battery, and associated fixed and variable resistors to enable precise zero adjustment and two measurement ranges, 0-10,000 and 0-100,000 ohms.

As a voltmeter, as many ranges as may be desired can be provided by suitably tapping the series resistors selected by the rotary switch. Seven a.c. and eight d.c. ranges are shown. These ranges are, of course, linear with and exactly proportional to the d.c. and a.c. scales, the latter being secured either on the meter or through a separate calibration chart of the a.c. rectifier.

As a multi-range d.c. milliammeter four ranges are diagrammed, 0-1, 0-10, 0-100, and 0-1000 ma. Additional ranges could be provided if desired. Heavy a.c. toggle switches are recommended, to reduce inaccuracies due to contact resistance.

The use of a multi-purpose meter of this type necessitates precautionary examination before each measurement to make sure that the respective controls are properly adjusted; otherwise, the instrument will quite likely be seriously damaged. When measuring unknown voltages or currents it is an excellent idea to begin with the highest range, thus identifying the proper range for most accurate measurement. As an ohmmeter, the instrument should never be connected across a circuit in which current is flowing; that is, the receiver power should be turned off when resistance measurements are made.

## Receiver Alignment Equipment

● For aligning receivers, particularly the i.f. amplifiers in superheterodynes, and checking receiver frequency ranges, a low-power oscillator, giving a wide continuous frequency range, is extremely useful. Such a "test oscillator" preferably should have a means for varying the strength of the signal; provision

should also be made for modulating the signal, in order that alignment may be accomplished by the use of a rectifier-type a.c. voltmeter (such as just described) as an output meter, or, in the absence of indicating instruments, by ear alone. An oscillator thus equipped is known as a "signal generator."

The diagram of a signal generator designed to operate directly from the 115-volt line, and having a continuous frequency range from 450 kilocycles to 60 megacycles, is given in Fig. 1715. The construction is shown in Figs. 1713-1714. A type 6K7 tube is used as an electron-coupled oscillator and a 6C5 as a variable audio-frequency generator, while a type 80 rectifier supplies the requisite d.c. plate power.

A turret-type coil-changing assembly (made by Communications Products, Inc.) enables efficient band-changing without the long leads ordinarily necessitated by switch assemblies.

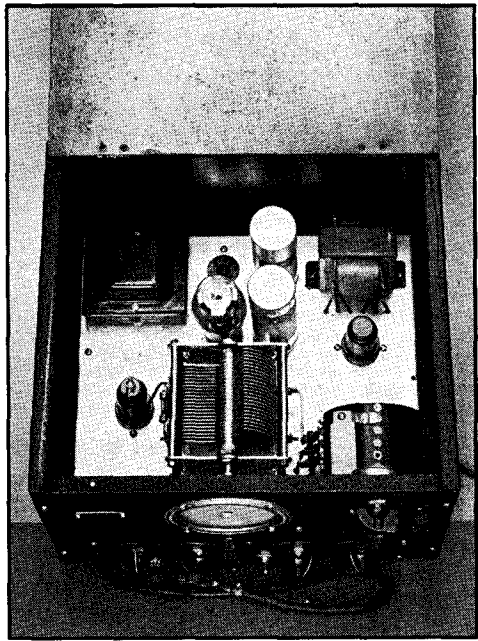

FIG. 1713 — THE ALL-WAVE SIGNAL GENERATOR

Housed in the standard metal shielded cabinet are an electron-coupled oscillator with a frequency range of 60 mc. to 450 kc., an audio oscillator covering 100 to 10,000 cycles, and the associated power supply.

Left to right on the bottom, below the Gordon precision vernier dial, are the shielded output lead terminating in test clips, r.f. attenuator control, attenuator switch, power on-off switch, modulator on-off switch, main oscillator frequency control switch, and intermediate control switch. Above this control, in the center, appears the band-change knob, with the a.f. output terminals and level control at the upper right.



## . . . . . Instruments and Measurements

Unused coils are shorted to ground. High-C in the tuned circuit lends stability; on the three high-frequency bands the capacity ratio is 10 to 1 (100  $\mu\mu\text{fd.}$  to 1000  $\mu\mu\text{fd.}$ ), while in the low-frequency and i.f. band the ratio is 20

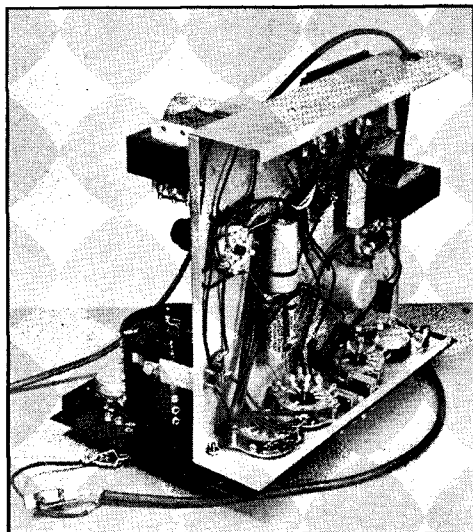

**FIG. 1714 — ADEQUATE SPACING OF PARTS MAKES CONSTRUCTION EASY AND OPERATION TROUBLE-FREE IN THE SIGNAL GENERATOR**

Location of the attenuator circuit beneath the sub-panel provides additional isolation, reducing leakage output at the all-off position. Visible in the left center are the r.f. output chokes and the filter choke. The 6C5 socket at the right center has its various circuit components surrounding it, while the power supply units are located at the lower left. The bleeder-voltage divider resistor is so located as to minimize frequency variations caused by its radiated heat.

to 1, enabling the coverage of an extremely wide range with but four interchangeable coils. The attenuator consists of a potentiometer, so connected as to present a constant impedance to the receiver input terminals, and a three-position switch giving high- and low-output and a short-circuited position (necessary when working directly into the antenna circuit of high-sensitivity receivers).

A separate audio oscillator employing a triode with cathode feedback and bias provides twenty different audio frequencies between approximately 100 and 10,000 cycles. The frequency is controlled by means of taps on the oscillator inductances and four tuning capacities, selected by two rotary switches. The 4-position capacity switch selects the major ranges, the inductance switch providing intermediate steps. The output of this generator is

used to suppressor-grid modulate the oscillator, with transformer coupling and an output level control. A modulation percentage of 100 is achieved with this control about one-half on; ordinarily only from 30 to 50 per cent modulation is permissible, and the control must be retarded to provide from 8 to 15 volts output. Binding posts on the panel enable utilization of the output of this a.f. generator for external purposes, such as checking modulation in transmitters, etc. The output wave-shape is not a perfect sine wave, the iron-core inductance rendering such a condition unattainable, although harmonic content has been minimized; this must be considered in checking amplifier distortion, only direct simultaneous oscilloscopic examination of both input and output being feasible.

In aligning single-signal receivers utilizing piezoelectric crystal filters, it is frequently desirable to use the crystal itself to control the test oscillator employed in lining up the i.f. amplifier. Ordinary oscillators do not permit such adaptation. In the signal generator above described an extra 4-prong socket has been installed, to which are brought filament and

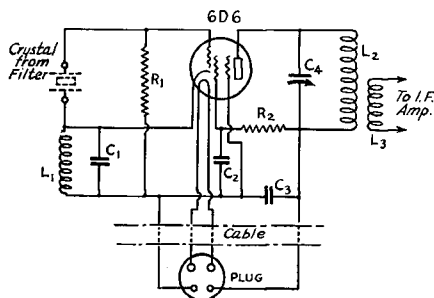

**FIG. 1716 — EASILY-ASSEMBLED CRYSTAL OSCILLATOR TO BE USED WHEN ALIGNING S.S. RECEIVERS WITH THEIR OWN CRYSTALS**

The whole assembly can be built around the oscillator tube socket, the cable and plug being inserted directly into the signal generator previously described.  $L_1$ - $C_1$  are provided to ensure oscillation; many s.s.-type crystals refuse to oscillate in ordinary circuits.  $C_1$  — .001- $\mu\text{fd.}$  fixed mica midget condenser.  $C_2$ ,  $C_3$  — .1- $\mu\text{fd.}$  400-volt tubular paper condensers.  $C_4$  — 100- $\mu\text{fd.}$  midget air tuning condenser.  $R_1$  — 50,000-ohm 1-watt carbon-type fixed resistor.  $R_2$  — 50,000-ohm 1-watt fixed resistor.  $L_1$  — 25 turns medium-size magnet wire, hank-wound on 2-inch diameter.  $L_2$  — 175 turns medium-size magnet wire, hank-wound on 2-inch diameter (to cover most crystals in 450-550 kc. region; if resonance cannot be found, some cutting or adding may be necessary).  $L_3$  — Pick-up coil. Two to 15 turns of wire wound with  $L_2$ , the ends connected between grid and ground; adjust number of turns and coupling in accordance with amount of signal desired.

# The Radio Amateur's Handbook . . . . .

plate voltages. Into this socket the crude and inexpensive but effective crystal oscillator diagrammed in Fig. 1716 can be plugged, affording direct alignment of the receiver with its own crystal. This alignment completed, the crystal can be re-inserted in the receiver, and the signal generator used for final touching-up.

Applications and modes of use for both the r.f. signal generator and a.f. generator are given in Chapters Seven and Thirteen.

## Vacuum Tube Voltmeters

● In the measurement of audio-frequency and radio-frequency voltages, where the use of a power-consuming measuring device is unsatisfactory because of the small power in the circuit, the vacuum-tube voltmeter finds wide application. Most vacuum-tube voltmeters used by amateurs measure peak voltages. The voltmeter tube, which may be a triode or screen-grid type, is biased nearly to plate-current cutoff, a current of a fraction of a milliampere being taken as a reference, called the "false zero." When a voltage is applied between grid and cathode the plate current will rise; the grid bias voltage is then increased until the plate current returns to the false zero. The additional bias voltage required to bring the plate current back to the reference value

will be equal to the peak value of the signal being measured. Because the measurements of the peak voltmeter are substantially independent of wave-form, this type of voltmeter is useful in audio and radio-frequency measurements since the capabilities of vacuum tubes are determined by the peak voltages and currents which must be handled. A simple but entirely practical voltmeter of this type is shown in Fig. 1717. It is known as the "slide-back" type. In operation,  $R_1$  is turned all the way to the right, with zero reading on the voltmeter  $M$ .  $R_2$  is then adjusted until the desired "false zero" point is read on the milliammeter  $M$ . The voltage to be measured is then applied, causing the milliammeter reading to increase.

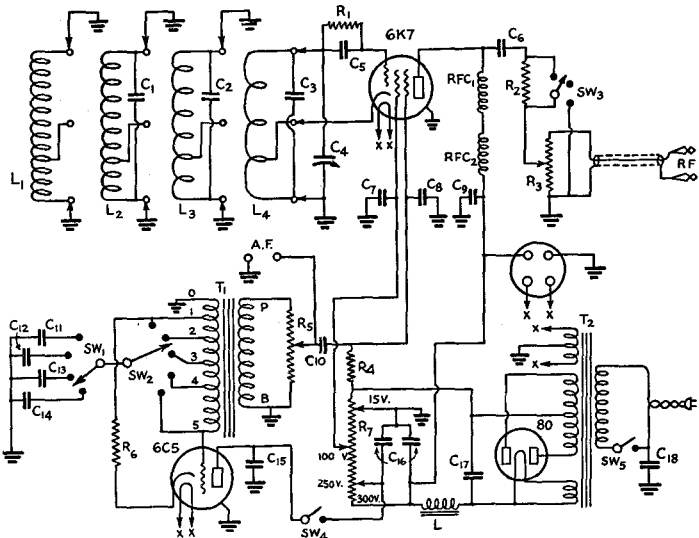

FIG. 1715 — SIGNAL GENERATOR CIRCUIT DIAGRAM

- $C_1$ - $C_2$ - $C_3$ —50- $\mu$ fd. midget mica condensers (mounted in the coil assembly).
- $C_4$ —1000- $\mu$ fd. variable air condenser with shaped plates (Cardwell XR-1000-HS).
- $C_5$ —100- $\mu$ fd. fixed mica condenser.
- $C_6$ —.01- $\mu$ fd. fixed mica condenser.
- $C_7$ ,  $C_9$ ,  $C_{10}$ ,  $C_{18}$ —.1- $\mu$ fd. 400-volt paper condensers.
- $C_8$ —600- $\mu$ fd. fixed mica condenser.
- $C_{11}$ —.25- $\mu$ fd. 200-volt tubular paper condenser.
- $C_{12}$ —.05- $\mu$ fd. 200-volt tubular paper condenser.
- $C_{13}$ —.0025- $\mu$ fd. 200-volt tubular paper condenser.
- $C_{14}$ —500- $\mu$ fd. fixed mica condenser.
- $C_{15}$ —.5- $\mu$ fd. 400-volt tubular paper condenser.
- $C_{16}$ —Dual 8- $\mu$ fd. 450-volt electrolytic condenser.
- $C_{17}$ —12- $\mu$ fd. 450-volt electrolytic condenser.
- $C_{18}$ - $C_{19}$ —.1- $\mu$ fd. 400-volt tubular paper.
- $R_1$ —50,000-ohm  $\frac{1}{2}$ -watt fixed resistor.
- $R_2$ —500-ohm  $\frac{1}{2}$ -watt fixed resistor.
- $R_3$ —500-ohm carbon-type potentiometer (not shielded).
- $R_4$ —5000-ohm  $\frac{1}{2}$ -watt fixed resistor.
- $R_5$ —.5-megohm potentiometer.

- $R_6$ —2000-ohm  $\frac{1}{2}$ -watt fixed resistor.
- $R_7$ —25,000-ohm 25-watt adjustable fixed resistor (with three taps).
- $T_1$ —Universal output transformer to 500-ohm line (Thordarson T-6125).
- $T_2$ —275-volt 40-ma. power transformer, with 6.3-volt 2-amp. and 5-volt 2-amp. filament windings.
- $L$ —30-henry 40-ma. filter choke.
- $L_1$ —60 to 18 mc. coil—3 turns No. 14 tinned wire,  $\frac{1}{2}$ -inch dia.  $\frac{3}{4}$ -inch long, tapped 1 turn from ground.
- $L_2$ —18 to 6 mc. coil—7 turns No. 18 tinned wire,  $\frac{7}{8}$ -inch dia.  $\frac{1}{8}$ -inch long, tapped 3 turns from ground.
- $L_3$ —6 to 2 mc. coil—24 turns No. 24 d.c.c. wire,  $\frac{7}{8}$ -inch dia.  $1\frac{1}{2}$ -inch long, tapped 8 turns from ground.
- $L_4$ —2 to .45 mc. coil—125 turns No. 28 d.s.c. wire,  $\frac{7}{8}$ -inch dia.  $2\frac{1}{4}$ -inch long, tapped 45 turns from ground.
- $RFC_1$ —2.5- $\mu$ h. receiving-type choke (National R-100).
- $RFC_2$ —10- $\mu$ h. shielded sectionalized choke (Hammarlund CH-10-S).

## . . . . . Instruments and Measurements

$R_1$  is then adjusted until false zero again is read on  $M$ , whereupon the voltmeter will read the voltage being measured. If the voltage to be measured is greater than 9 volts, additional bias can be placed at the point marked  $X$ , the exact value being read by an auxiliary voltmeter. We would refer the reader to more de-

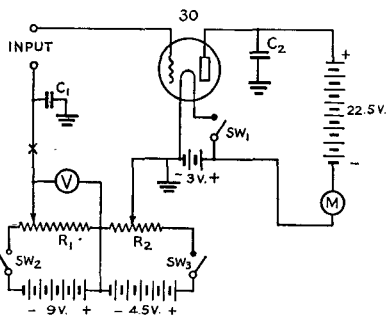

FIG. 1717 — SIMPLE PEAK-TYPE VACUUM-TUBE VOLTMETER

- $C_1$  — 500- $\mu$ fd. mica fixed condenser.
- $C_2$  — .01- $\mu$ fd. mica fixed condenser.
- $R_1$  — 2,000-ohm wire-wound potentiometer.
- $R_2$  — 1,000-ohm wire-wound potentiometer.
- $SW_1, 2, 3$  — Battery on-off switches; may be ganged.
- $M$  — 0-1 milliammeter (any low-range milliammeter or microammeter may be used).
- $V$  — 0-10 voltmeter, 1000 ohms per volt.

tailed descriptions of advanced types of v.t. voltmeters in the August and October *QST*, 1936.

### Field-Strength Meters

● An item in the equipment of the advanced radio amateur that is increasing in importance and general use is the field-strength meter. Its uses are numerous, the more important being the ability it lends to correctly adjust antenna and transmitter characteristics under actual radiating conditions. This facility is of particularly great importance on the ultra-high frequencies, where an effective field-strength meter represents about the only reliable method of adjustment, especially on low-power equipment or where directive antenna arrays are used.

A simple field strength meter particularly suitable for work in the ultra-high frequency region is shown in Fig. 1718. The circuit diagram is given in Fig. 1719. Essentially, the meter consists simply of an acorn triode operated with very low plate voltage and biased to cut-off, constituting a linear detector. When the signal under observation is tuned in, rectification occurs, and the plate current increment is read on the microammeter. Among the uses to which this meter can be put are: (1) Measur-

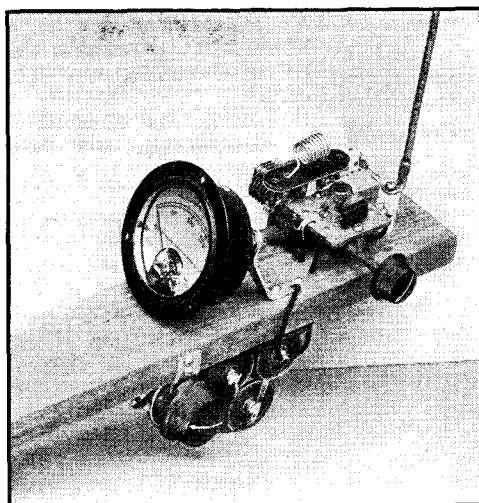

FIG. 1718 — SIMPLE FIELD-STRENGTH METER USING ACORN TUBE

The board-type construction facilitates construction and provides a convenient handle, minimizing body-capacity effects when making observations.

ing comparative transmitter outputs under different adjustments. (2) Neutralizing amplifiers (using only a pick-up coil, without the

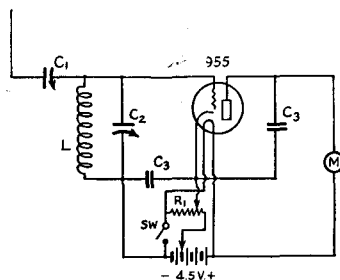

FIG. 1719 — CIRCUIT OF THE SIMPLE FIELD-STRENGTH METER

- $C_1$  — 30- $\mu$ fd. adjustable mica trimmer condenser.
- $C_2$  — 35- $\mu$ fd. midget air trimmer condenser.
- $C_3$  — 250- $\mu$ fd. midget mica fixed condensers.
- $R_1$  — 1000-ohm midget potentiometer.
- $L$  — 50-80 mc.: 7 turns No. 14 tinned wire,  $\frac{1}{2}$ -inch dia. 1-inch long.
- 25-40 mc.: 10 turns No. 14 tinned wire,  $\frac{3}{4}$ -inch dia. 1-inch long.
- 12-20 mc.: 20 turns No. 16 enamel wire, close-wound on  $\frac{3}{4}$ -inch diameter bakelite tubing.
- 6-10 mc.: 37 turns No. 22 enamel wire, close-wound on  $\frac{3}{4}$ -inch tube.
- 3-5 mc.: 75 turns No. 30 d.s.c. wire, close-wound on  $\frac{3}{4}$ -inch tube.
- 1.5-2.5 mc.: 75 turns No. 30 d.s.c. wire, close-wound on 2-inch tube. (The above ranges are only approximate.)
- $M$  — 0-200 microamperes (a higher-range meter, although not as satisfactory, can be used if necessary).

# The Radio Amateur's Handbook

antenna). (3) Measuring comparative antenna radiation under different adjustments. (4) Deriving field-strength patterns of, and adjusting, u.h.f. beam antennas.

A more sensitive field-strength meter of particular utility in examining the field strength patterns of lower-frequency antenna systems is shown in Figs. 1720-1721. It consists of a diode rectifier and d.c. amplifier in the same envelope. The initial plate current reading is in the neighborhood of 1.4 milliamperes; with signal input, the current dips downward. The scale reading is linear with signal voltage, a characteristic that is advantageous in making certain types of comparative measurements. Radiated power variations will, of course, be as the square of the field voltage indication. With a 1.5-milliamperere meter, field strengths of fractional millivolts register on the meter, if a copper-rod antenna two or three feet long is used.

The construction of the device is quite simple, an aluminum box assembled with square-rod corner pieces containing all parts but the coil and pick-up rod. The location of the coil makes it possible to couple closely to the various stages of a transmitter.

## Cathode-Ray Oscilloscopes

● Perhaps the most useful of all measuring and testing devices is the cathode-ray oscilloscope. Although relatively expensive, its

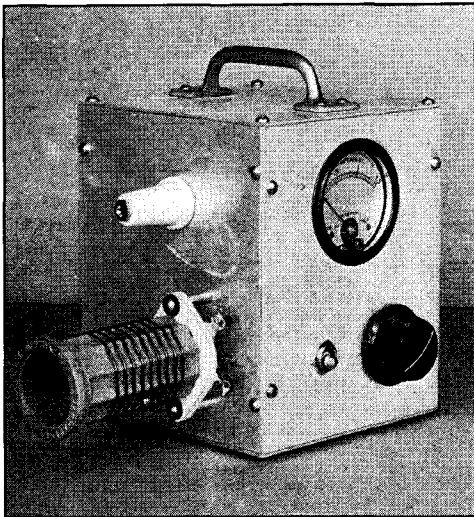

FIG. 1720 — SENSITIVE FIELD-STRENGTH METER

This meter is particularly useful on the lower-frequency amateur bands; it can be used for both transmitter and antenna adjustment, and in making field-strength patterns.

applications are so numerous that it can be used to replace a number of other less satisfactory types of measuring equipment. It is particularly suited to r.f. and a.f. voltage measure-

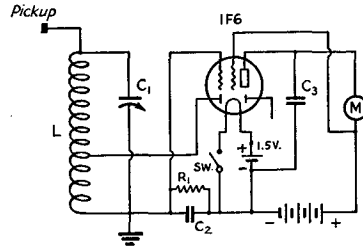

FIG. 1721 — THE TWO-STAGE FIELD-STRENGTH METER CIRCUIT DIAGRAM

- C<sub>1</sub> — 50- $\mu$ fd. midget variable condenser.
- C<sub>2</sub> — 250- $\mu$ fd. midget mica fixed condenser.
- C<sub>3</sub> — .002- $\mu$ fd. midget mica fixed condenser.
- R<sub>1</sub> — 1-megohm  $\frac{1}{2}$ -watt fixed resistor.
- L — Wound on  $\frac{1}{2}$ -inch coil forms, winding length  $1\frac{1}{2}$  inches, diode tap in center of coil:
  - 1.5-3 mc.: 58 turns No. 28 d.s.c. wire, closewound.
  - 3-6 mc.: 29 turns No. 20 enamel wire, closewound.
  - 6-12 mc.: 15 turns No. 20 enamel wire, spaced.
  - 11-22 mc.: 8 turns No. 20 enamel wire, spaced.
  - 20-40 mc.: 4 turns No. 20 enamel wire, spaced.
  - (Above ranges are approximate only.)
- M — 0-1.5 milliamperes.

The filament battery consists of two flashlight cells wired in parallel. The plate battery is a small portable "B" battery, Burgess type Z30P.

Care should be taken to connect the diode plate on the negative filament leg, otherwise an initial bias will be placed on the rectifier and it will not function properly.

ments because it does not consume power from the source being measured.

The circuit diagram of a simple cathode-ray oscilloscope is given in Fig. 1722. In building such a unit one precaution, in particular, must be observed: the tube must not be placed so that the alternating magnetic field from either of the transformers has any effect upon the electron beam.

A second essential, especially important where the oscilloscope is to be used for checking a powerful transmitter, is to prevent stray r.f. voltages from getting into the supply circuits via the a.c. line. Two 0.01- $\mu$ fd. condensers (C<sub>1</sub>), connected in series across the line with the midpoint grounded to the cabinet, will usually be effective. In some cases, however, it may be necessary to increase the size to 0.1  $\mu$ fd. The condensers must be mounted inside the cabinet where they will not be in the field from the transmitter.

Supplementing the voltage controls indicated in Fig. 1722, it is desirable to make provision for rotating the cathode-ray tube socket so that the horizontal and vertical sweep lines

## . . . . . Instruments and Measurements

actually are horizontal and vertical. The earth's magnetic field has some effect on the electron beam and may cause the lines to be tilted. This can be overcome by proper orientation of the tube. The whole instrument should be enclosed in a metal box, preferably steel or iron, to shield it from stray fields. Without shielding it is difficult to bring the electron beam to a sharp focus.

In this oscilloscope the horizontal sweep voltage can be obtained either from an audio-frequency source (such as the modulator stage of a transmitter) or from the 60-cycle line. Using an a.f. horizontal sweep, the pattern appearing on the screen will be in the form of a trapezoid or triangle (depending on the percentage of modulation) when checking transmitter performance. Practical application of this method is outlined in Chapter Eleven. For an

understanding of the operation of the cathode-ray tube, reference is made to the description in Chapter Five.

Although for many amateur applications the use of a sweep circuit having a linear time base is not essential, for actual studies of wave form the linear time axis is necessary. Such circuits can be found in the standard cathode-ray tube manuals supplied by manufacturers and in the specialized books on the subject; space precludes their presentation here. The sweep circuit proper usually employs a grid-controlled gaseous discharge tube, the 885 (especially designed for this purpose), operating as a relaxation oscillator. In order for the time axis to be linear a condenser in the output circuit is caused to charge at a uniform rate. To accomplish this a pentode-type current-limiting tube is connected in series with the power supply.

In operation, the sweep circuit is connected to the vertical plates of the existing oscilloscope. The voltage under observation is connected to the horizontal plates, the necessary variables are adjusted, and the resulting picture is an accurate representation of the wave shape of the voltage being examined.

The use of oscilloscopes for alignment and testing of receivers involves still another technique. To show the resonance characteristic of the receiver it is necessary not only to show the response at the carrier frequency but at all adjacent frequencies through the pass-band. To accomplish this,

a motor-driven variable condenser, or "wobbler", is often incorporated in the signal generator, automatically tuning the oscillator frequency over the desired range (usually about 20 kc.) at a fixed rate of speed. An auxiliary set of contacts on the motor shaft serve to provide an external synchronizing voltage for the horizontal plates; an iron bar rotating the field of a horseshoe magnet is often used, pickup coils on the magnet connected to the horizontal plates providing the alternating sweep voltage. The vertical plates of the oscilloscope are connected to the second detector or first audio stage through a suitable amplifier.

External amplifiers, usually of the resistance-coupled type to provide high gain with wide frequency range and low distortion, are useful in most applications. The standard 3-inch cathode-ray tube, with a sensitivity of approximately 40 volts per inch, is not suitable for use with potentials of less than several volts,

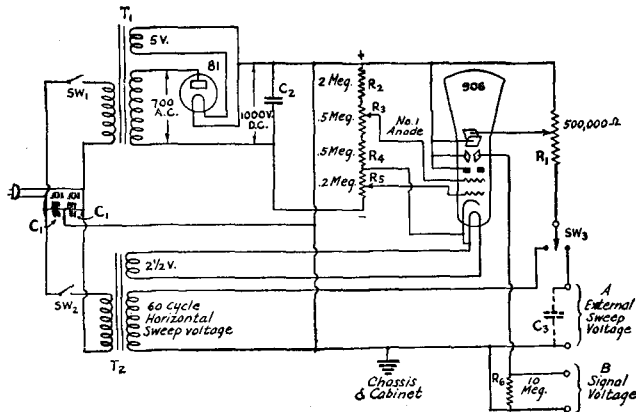

FIG. 1722 — SIMPLE OSCILLOSCOPE CIRCUIT FOR CHECKING AMATEUR TRANSMITTERS

- $C_1$  — .01- $\mu$ fd. 200-volt tubular paper by-pass condensers.
- $C_2$  — 1- $\mu$ fd. 1000-volt (working) paper filter condenser.
- $C_3$  — 500- $\mu$ fd. fixed mica condenser (for r.f. by-pass, if necessary).
- $R_1$  — 500,000-ohm potentiometer (sweep voltage control).
- $R_2$  — 2-megohm 1-watt fixed resistor.
- $R_3$  — 500,000-ohm potentiometer (intensity control).
- $R_4$  — 500,000-ohm 1-watt fixed resistor.
- $R_5$  — 200,000-ohm potentiometer (focusing control).
- $R_6$  — 10-megohm 1-watt fixed resistor.
- $T_1$  — Receiver-type power transformer, designed to deliver 350 volts a.c. each side of center-tap (c.t. not used), with 5-volt rectifier filament winding.
- $T_2$  — Heater supply and sweep-voltage transformer. Primary-to-sweep-voltage ratio approximately 1-to-1. (Two units, a regular filament transformer and a 1-to-1 audio output transformer, may be used if necessary.)
- $SW_1, SW_2$  — Single-pole single-throw toggle switches (may be ganged, or in one unit).
- $SW_3$  — Single-pole double-throw sweep-circuit switch.

## Assembling the Amateur Station

### LOCATION OF STATION—OPERATING POSITION— STATION LAYOUT—BREAK-IN AND REMOTE CON- TROL—ANTENNA INSTALLATION—MASTS

**I**N THE preceding chapters we have seen how all the component parts of an amateur station may be designed and built, and we have come to know that a complete station consists of a receiver, a transmitter with power supply, a monitor or frequency meter or both, and suitable antennas for transmission and reception. Many amateurs, on completion of the necessary units for their station, are so anxious to put the outfit into operation that they merely toss the apparatus on a table, connect it up in some haphazard fashion and begin operating. Mediocre results attend this setup and the installation is never given a chance to perform at maximum efficiency. This procedure frequently results in danger to the operator and his family from exposed wiring. It invariably leads to unreliable and unsatisfactory operation of the equipment. One does not need a powerful transmitter or an elaborate receiver to have a fine amateur station.

It should be recognized from the start that in the final analysis the ultimate pleasure in an amateur station can be derived only when the greatest efficiency is being realized

from each piece of gear. This, plus individual neatness and originality, gives that pride of ownership, whether the station be the most elaborate or the simplest.

#### Finding a Location

● The first problem encountered in building a station is usually the selection of a suitable space in the house. Some fortunate amateurs are able to provide a special "shack" away from the house. Others are able to monopolize an entire room for their station. Many amateurs, however, are obliged to content themselves with a corner of the basement, their bedroom or the attic. Some fellows, living in apartments, have even been restricted to the space under the kitchen stove. Still others, for the sake of convenience and comfort, have built their transmitter and receiver into a small cabinet located in the living room, the heavier power supply apparatus being arranged in the basement.

Some amateurs put their rigs in roll top desks, others use bookcases. Apartment dwellers resort to gear under daybeds or shelves in closets. We recently

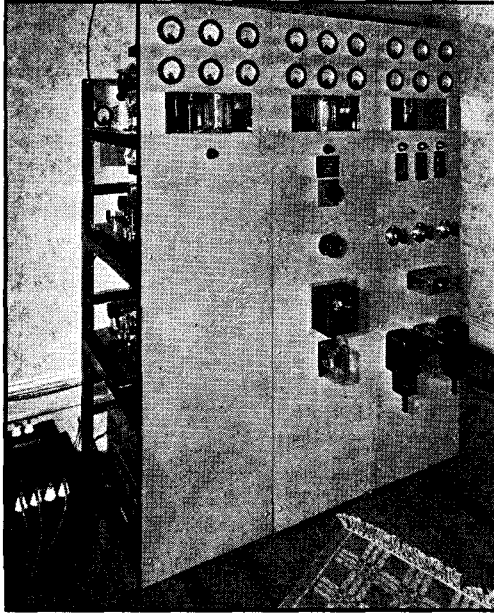

**RADIOTELEPHONY CARRIED TO THE POWER LIMIT  
AT W3FVF**

*The complete transmitter is on one side of a room with controls at the operating position across the room. This transmitter contains many ingenious safety devices and relays as well as home-made transformers and miscellaneous gear all assembled into a rig with commercial standards.*

## . . . . . *Assembling the Amateur Station*

heard of the amateur who concealed his rig in a modern "hope" chest!

Further schemes for the amateur limited in space are made available by remote control



**OPERATING POSITION AT W2BYP**

*Everything in its proper place with no unnecessary apparatus cluttering up the table. Speech amplifier and transmitter controls are at the left of the receiver. The frequency meter is at the right of the receiver with the telegraph keys.*

methods — some typical examples of which are given later in this chapter. With remote control, the transmitter and its power supply may be located in the attic, in the basement, or in a specially built "dog-house" in the back yard. The receiver and control switches may then be located in a small cabinet in the living room or on a small table in any other room available.

There is certainly room for an amateur station in any house or apartment.

### **The Operating Position**

● In picking the operating position it should be realized from the start that it will be here that long vigils will be kept. Schedules will be kept without regard to outside atmosphere or weather. Pick your operating spot with care, even sacrificing space for comfort. One can always cook up remote control ideas if a single space for receiver and transmitter is not available.

Convenient operation of a station calls for ample space around the receiver and key. There must be room for the log book, call book, message blanks and miscellaneous pa-

pers. For this reason, it is almost universal practice to use a table or desk as the operating position. On the operating table there should be no superfluous gear or material.

The items which are handled most frequently are the receiver, power switches, key, frequency meter and monitor. It is well, therefore, to group all of these on the table or desk selected. Perhaps the most popular practice is to place the receiver towards the left of the table. The monitor is then located alongside the receiver on the right (where it is near enough to give a good signal in the receiver) and the key is screwed to the table slightly to the right of this and far enough back to give a good support for the operator's arm. If one does not wish to scratch the table top by screwing a key to it, a worn edition of the *Handbook* will give enough weight. It is also thick enough to carry screws without marring the table top.

Down through the years *QST* has continually sought to simplify operating methods and switching. In days gone past the amateur station that most nearly resembled a panel in a power house was the one that caught the eye. However, this practice has gradually been superseded by the more practical and obvious methods of handling transmissions. It is quite common practice to turn on the filaments of transmitting and rectifier tubes upon entering

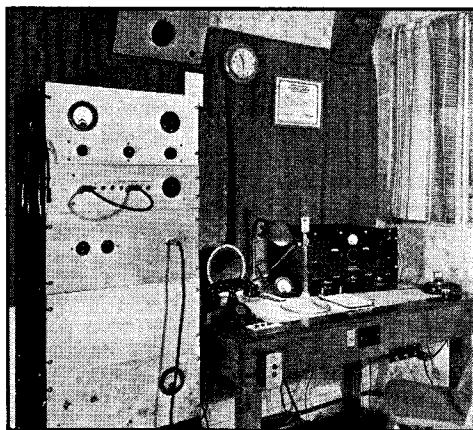

**THIS IS THE OTHER SIDE OF THE ROOM AT W3FVF**

*Speech amplifier, mixing panels and power supplies are carried on the panel at the left of the operating table. Transmitter controls and modulation indicator are at handy points on the table. On the wall above the table is mounted a speaker and its baffle tilted forward.*

the operating room and not turn them off until leaving. This insures tubes, especially mercury-

vapor rectifier tubes, against breakdown if plate voltage is applied before the filaments are up to temperature. This leaves only one other operation to put the transmitter on the air — application of plate voltage. All plate transformers can be applied by one switch in the primaries. Then, upon closing the key the station is on the air. Break-in operation should be the aim of all operators. It will come in handy many times and save long calls and wasted time — especially important to the DX or traffic man.

For the 'phone man break-in operation may take the form of "push to talk." Many methods of accomplishing this have been shown from time to time in *QST* and *Hints and Kinks*. Perhaps the easiest method is by having a switch in the crystal oscillator circuit. When the switch is open the crystal will not be oscillating and the amplifiers will have no excitation. The instant the switch is closed the crystal will oscillate and amplifiers will pick up. Advance has been made in the art of crystal grinding and oscillator tubes and circuits so that it is even possible and quite practical to key the crystal oscillator.

Two switches should also be fitted on the table — one for the primary of the filament transformer and one in the supply circuit to the plate supply apparatus. These switches can be mounted under the front edge of the table in a position convenient for right-hand operation. With low-power transmitters, the filament and plate power are often supplied by one transformer; in such a case only one powerline switch will be necessary.

It is usually inadvisable to mount the transmitter or power supply on the operating table. In the case of the self-controlled transmitter, indeed, it is extremely bad practice. All such transmitters are susceptible to vibration and to the effects of "body capacity." Consequently, they cannot be expected to deliver an output of constant frequency when subject to the vibration of keying and the movements of the operator. It is very much better, even in the case of a crystal-controlled set, to mount the transmitter itself on a shelf supported from the wall, on a separate table, or in a special frame.

In crystal-controlled 'phone transmitters frequency modulation has even been traced to transformer vibration. Generally, crystal control is insurance against any frequency modulation, provided the circuits are working properly. In any case, the transmitter should be conveniently placed with respect to the feeder or antenna leads.

Separation of transmitter and receiver is also helpful in keeping unwanted r.f. from

transmitter leads out of the receiver circuit. Often the receiver is used as a monitor in which case a separation at least across the room keeps the receiver from "blocking" when listening to the transmitted signal. A shielded receiver and single-pole single-throw switch in the receiver antenna lead right at the receiver will in most cases be ample insurance that the receiver can also be used as the moni-

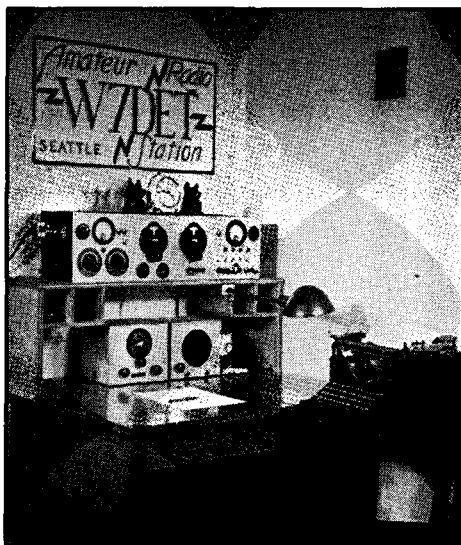

AN ATTRACTIVE LOW-POWER STATION AT W7DET

*The transmitter is built on a wooden frame and mounted above the receiver. It is complete in one unit. The receiver and speaker complete the gear on the table with plenty of compartments for files, pencils, cards and small gadgets.*

tor. It is always helpful to those learning to send to be able to listen to their own sending. Should the transmitter become unstable the monitor will show up this condition the moment it occurs. The ideal method is to have a separate monitor-frequency meter.

Some operators have a double-throw double-pole switch with the headphones across the switch arms. While sending the switch is changed to the position that will throw the headphones in the plate circuit of the monitor and when receiving the switch position is reversed, with the headphones going in the plate circuit of the receiver. Another method which will save switching is to procure a push-pull audio transformer. One secondary is wired in series with the plate circuit of the monitor and the other secondary is wired in series with the output of the receiver audio. The headphones are across the primary of the transformer. The



## . . . . . *Assembling the Amateur Station*

monitor is set on the frequency of the transmitted signal. Regardless of where the receiver is tuned the transmitted signal will be heard when the key is pressed, unless the transmitter has "hopped" frequency. Thought and perusal of other chapters of the *Handbook* will bring other ideas to light.

The power supply equipment of even a low powered transmitter requires careful placement because of the danger involved. It should not be on the operating table nor should it be

This is important in keeping r.f. out of audio circuits. All leads running from r.f. portion of transmitter to audio should be in metal conduit and grounded. The radiotelephone layout that has the r.f. portion on one side of the room and the audio on another will be the easiest to keep r.f. out of audio system. Audio equipment should be kept away from radiating feeders, as well. In transmitters with some form of grid modulation it is altogether practical to have the audio gear compact in a shielded box on the operating table with only the gain control on the panel. For transmitters that require more audio power the preamplifier may be on the operating table, with low-impedance line to S.A. and modulator.

It is futile, of course, to attempt to outline every possible arrangement of the components of the station. It is better that the amateur should make a study of the stations he visits (and of those illustrated in this chapter and in *QST*) with the idea of improving on them or at least

adapting them to his particular needs.

### A Simple Remote Control System

● Amateurs are turning in greater numbers to break-in operation and, though to a lesser extent, to remote controlling of transmitters. Both of these systems have been considered standard equipment on commercial installa-



**COMPLETE STATION AT W2BSD**

*This station contains commercially-designed and built equipment. Temperature-controlled crystals continuously monitored by a heterodyne frequency meter are employed. Special antennas complete this modern amateur station.*

under the table in a position where the operator's feet could come in contact with it. Often it is placed on a shelf under the transmitter table or frame. Alternatively, it could be in a large and well ventilated box under the operating table and off to one side.

The transmitter should be placed in the shack with regard to the operating position and the antenna feeders. The feeders should go directly to the transmitter in as short and straight a manner as is practicable. Often, the antenna series condensers and meters are set on insulators and screwed to the window frame right where the feeders enter the shack.

When radiotelephony is contemplated a great deal of care must be exercised in the manner of placing the audio gear with respect to the radio-frequency apparatus.

Line transformers should be used in coupling audio circuits if there is more than 10 feet between respective amplifiers or transformers. Thus a low-impedance line well used which is much less susceptible to r.f. and the losses are negligible even up to several hundred feet. Great care should be used in the selection of transformers and connections to insure against improper impedance matching, which can result in a very great loss in power and fidelity.

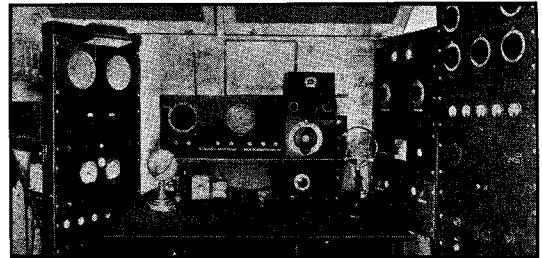

**W6FQY IS A HIGH-POWERED STATION WITH ALL THE APPARATUS BUILT AROUND THE OPERATING TABLE**

*The trend is towards commercial equipment and amateur construction to match. This method of mounting apparatus is very convenient, presents a neat appearance and is easy to work on.*

tions for several years past. The remote controlling system described in Fig. 1801 has been used at several shore stations in the mobile service and where the receiver is at even a short

distance from the transmitter permits perfect break-in operation with the use of a small separate antenna. This same system has been used with amateur rigs where the transmitter has been as much as 7 miles from operating position. In commercial installations the distances have been even greater — limited only by the sensitivity of the relays used. Keying speeds of approximately 250 words per minute have been used with perfect success.

The system's advantages, as may be readily seen, are its great simplicity and its making use of but a single line to perform several duties at the transmitter. The principle of operation is that of having the relays adjusted to operate at different *minimum* values. A careful study of the diagram will make this clear. No values have been shown for the various components. These will all be largely determined by, first the relays, and then the length (resistance) of the line.

The relays used should preferably be of the high resistance-low current "vacuum tube output" type but may, where the length of the line is not very great, be of the ordinary 2- to 12-volt types. Relay 1 is the start-stop control and Relay 2 is the keying control. Relay 1 must be adjusted to close on a current less than that necessary for Relay 2. For example, using relays adjusted to close at 5 and 10 milliamperes respectively, when switch *Sw* is closed resistances  $R_1$  and  $R_2$  will regulate the current flow through the line to 5 mils, which will cause  $Ry_1$  to close and start the transmitter. However, since  $Ry_2$  is adjusted to operate on a minimum of 10 mils it will remain open. When the key is closed, short circuiting  $R_2$  and permitting an increase in current,  $Ry_1$  will stay closed and  $Ry_2$  will close and will follow the make and break of the key circuit.

It should be added that the batteries used may both be at one end of the line. If at both ends it should be remembered that they are still in series and the voltage on the line is the sum of the two. If the line is very long its ohmic resistance must be considered. This, along with the characteristics of the relays, will determine the voltage needed.

## Remote Control, Push-to-Talk for Phone or C.W.

● A remote-control system which offers the feature of protection for the final stage in case of excitation failure, and in addition provides a push-to-talk arrangement in which the receiver is automatically cut off during transmitting periods, is shown in Fig. 1802. The filaments of the transmitter tubes are thrown on when the receiver power supply is turned on by means of the relay  $Ry_4$ , which is an automobile generator cutout rewound to operate on about 10 ma. Thus the current drawn by the receiver power-pack bleeder is enough to operate this relay, which closes the primary of the filament transformer,  $T_3$ .

Under ordinary circumstances the control system uses two push-buttons, one to start and one to stop. Under these conditions the switch, *Sw*, remains closed. Current to operate the

relays is taken from the receiver power supply, the relays being wound to operate on 22 volts at about 10 ma. The system operates as follows: When the "start" button is closed the relays  $Ry_1$  and  $Ry_3$  are energized.  $Ry_3$  has two sets of contacts, one a make and the other a break set. The break set cuts the negative "B" lead to the receiver, and the make set

locks the relay in the closed position. Relay  $Ry_1$  has two sets of contacts that make when closed; one set is used to lock the relay and the other set to close the primary of the plate-supply transformer for the oscillator, doubler and buffer. As the plate current comes up to normal in the buffer stage it closes relay  $Ry_2$  which is wound to operate in series with the buffer supply, and which in turn closes the primary circuit of the transformer which supplies plate voltage to the final amplifier and modulator. The final only comes on when getting excitation because of the operation of this relay.

The "stop" button shoots the voltage supply to the relays, thus opening them, cutting the transmitter and closing the "B" minus to the receiver.

The switch *Sw* is in the locking circuit of the

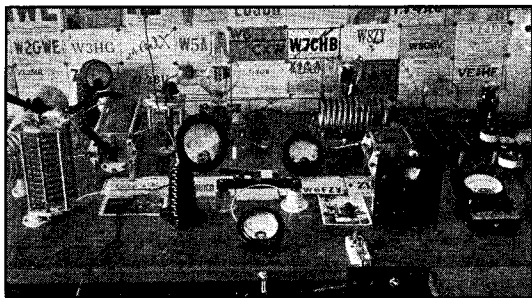

THE BREADBOARD LAYOUT AT EA4AV

*The amateur experimenter often finds the above method of transmitter layout very convenient. It is certainly easily accessible and saves mounting apparatus on panels.*

# . . . . . Assembling the Amateur Station

relays, and if left open the circuit may be used for "push-to-talk," since the relays will not hold themselves closed. When the start button is held down it puts on the transmitter and cuts out the receiver. When the button is let up the reverse takes place. This is similar to the airways system.

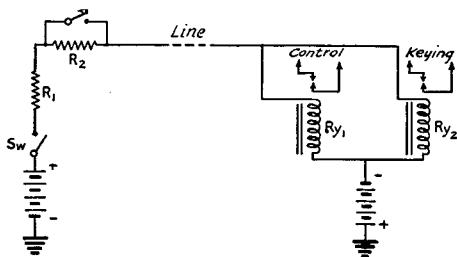

**FIG. 1801—A ONE-WIRE REMOTE CONTROL SYSTEM USING RELAYS OPERATING AT DIFFERENT CURRENT VALUES**

*The battery voltages and resistor values will depend upon the characteristics of the relays used.*

The excitation-failure protection can be made even more accident-proof if the relay  $Ry_2$  is made to operate from the final amplifier grid current. This would take care of accidental detuning of the buffer plate circuit, which might cause the tube to draw plate current without delivering excitation power.

The microphone and pre-amplifier would be at the operating position and the output fed into a low-impedance line by means of a tube to line transformer to the transmitter where a line to grid transformer would again match the audio circuit to be controlled.

Fig. 1803 shows an electronic relay that may be used for 'phone break-in work. To work the input circuit a volt of audio will be sufficient for control. The first 56 is a buffer tube between the speech amplifier and control tube which is 885. This tube is the heart of the system in that its control biases the power tube which opens and closes the relay.

The circuit works in the following manner. With the proper plate voltage applied to the three tubes the sensitive relay in the plate

circuit of the power tube will close as the tube is working without bias and taking about 15 ma. When audio voltage is applied at the input terminals it immediately starts the control tube (885). When the 885 breaks down there is a potential at its plate circuit which charges the coupling condenser to the grid of the power tube. This charge leaks off gradually after voltage is no longer applied to the input terminals depending on the resistance in the timing control. This potential is more than sufficient to block the power tube. Blocking this tube means that the plate current is instantly cut off and the relay is released to its back contact which controls the transmitter.

A variety of variations of the above can readily be figured out for the individual location. Tubes are very often used for time delay relays. A circuit showing this application appears in Fig. 1804. Briefly its operation is as follows. The tube is biased to a point where relay  $X_1$  will not hold in. When the contacts are closed the positive voltage applied bucks the fixed bias causing more plate current to flow. This closes relay  $X_1$  which in turn closes the power circuits which are on relay  $X_2$ . When the contacts at  $K$  are opened the tube will continue to draw enough plate current to hold in the relays. The time of this holding in is

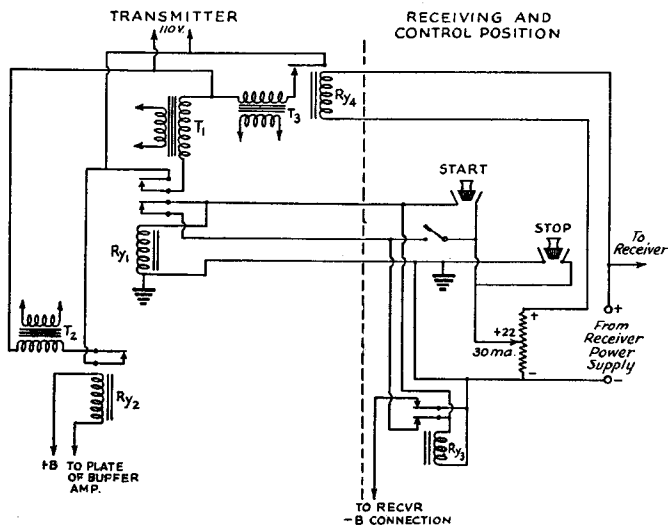

**FIG. 1802—REMOTE-CONTROL SYSTEM INCORPORATING "PUSH-TO-TALK" WITH AUTOMATIC RECEIVER CUT-OUT AND EXCITATION-FAILURE PROTECTION**

determined at the rate the charge in condenser  $C$  becomes discharged. This time is controlled by the variable resistor.

# The Radio Amateur's Handbook . . . . .

Actually putting the contacts at *K* in parallel with the normal keying circuit is not recommended. Preferably, the keying relay should be a double pole affair with one set of contacts controlling the transmitter and the other set of contacts going to *K* of the control circuit.

There are a great many variations of the application of this circuit and, of course, other tubes might be used. If one should experiment with this circuit he will find a great many uses to which it can be put in the operation of a transmitter or receiver.

## Underwriters' Rules

● Before actually starting on the installation and wiring of the complete station, the amateur should certainly make a study of the Underwriters' requirements.

The specific rules covering radio equipment are given in Article 37 of the National Electric Code, under the heading of "Radio Equipment." Some states have adopted this code or a more strict version of it. Certain cities have adopted it, too, and they enforce their regulations through municipal inspectors. Before making an installation it is well to find out if the apparatus and wiring are subject to a state and city inspection as well as to inspection by insurance interests.

"Approved" refers to devices designed for the purpose used in accordance with recognized practice. The device must be acceptable to the inspection department having jurisdiction (there may be a city or state inspector in addition to the insurance rating or inspection bureau). When there is no inspector for the city or state, insurance interests inspect through their rating organizations, one of which covers each part of the United States. Your local insurance agent can advise you in whose territory you are located so you can get in touch with the proper authority.

A conference with the inspection department *before* making an installation or change will save inconvenience and expense later. Your own interests and those of fellow citizens will be

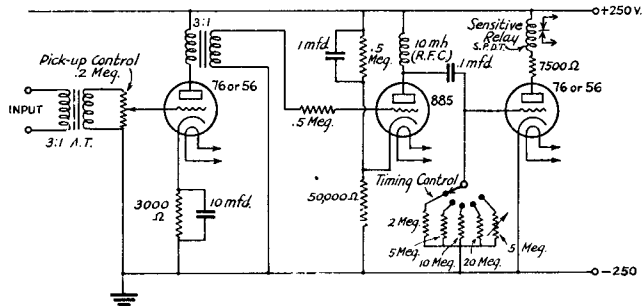
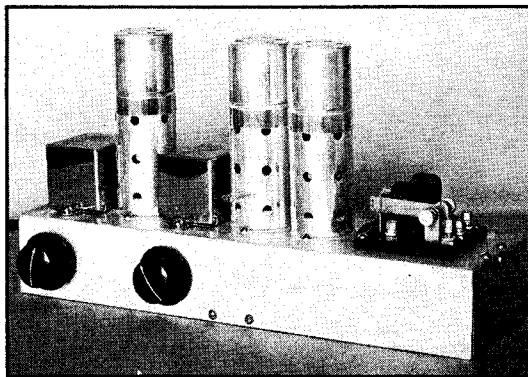

FIG. 1303 — VOICE-CONTROLLED RELAY FOR 'PHONE BREAK-IN WORK

*The input circuit should work at some point in the speech amplifier where there is a volt or two of audio at average speech levels. The relay contacts should be heavy enough to carry the current of the circuit to be broken. One satisfactory method of using this relay is to start and stop the crystal oscillator. Circuits following the crystal will need to be biased so they will not go wild when they lose excitation.*

best protected from an insurance and fire-hazard standpoint by having such a conference.

The wiring must follow the requirements observed in your particular community. In some instances a separate power line must be run directly to the watt-hour meter. A few feet of "BX" from the nearest outlet to a "Square-D" switch box, properly fused at the switch, will usually be satisfactory. The installation of high-voltage apparatus and wiring must be done in approved fashion. High-tension cable, supported on porcelain pillar insulators, keeping the high



**VOICE-OPERATED RELAY FOR 'PHONE OPERATION**  
*This electronic relay utilizes the circuit described in Fig. 1303. Rather complete shielding is recommended as the gas-filled 885 control tube may cause disturbance in the receiver. Shielded transformers are used.*

voltage away from all woodwork and neighboring conductors, is a safe type of construction.

A receiving antenna can be connected to ground before it gets to the set through either the in-door or out-door type of lightning arrester. Several approved types are sold by local

# • • • • • Assembling the Amateur Station

dealers with complete instructions for installation. These arresters usually are simply spark-gaps sealed in a vacuum to lower the voltage break-down. The ground can be made by scraping a water pipe or ground rod clean and bright with a file. A 10-cent ground-clamp will make a good connection to the pipe. A yearly inspection will insure a good ground. An approved lightning arrester operating at a po-

and low cost. The only lumber used is 2-by-2 straight-grained pine (which many lumber yards know as hemlock) or even fir stock. The uprights can be each as long as 22 feet (for a mast slightly over 40 feet high) and the cross pieces are cut to fit. Four pieces of 2-by-2 22 feet long will provide enough and to spare. The only other materials required are 5 1/4-inch carriage bolts 5 1/2 inches long, a few spikes, about 300 feet of No. 12 galvanized iron wire for the guys or stays, enough No. 500 ("egg") glazed porcelain strain insulators to break up the guys into sections and the usual pulley and halyard rope. If the strain insulators are put in every 5 feet approximately 30 of them will be enough.

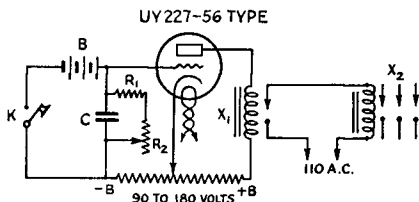

FIG. 1804 — AUTOMATIC SWITCHING CIRCUIT FOR CONTROLLING POWER SUPPLIES IN A TRANSMITTER

The contacts at K are preferably from a relay and are in parallel with the transmitting key. Thus the circuit can be adjusted to hold in the power supplies for a few seconds after one stops keying. To operate the transmitter it is merely necessary to start keying and the power supplies are automatically switched on with the first closing of the keying contacts and a hesitation over the length of time the delay is set for will automatically open the power supply relays.

K — Contacts in parallel with keying relay or hand key.

C — 4 to 8 μfd. low voltage paper condenser. It must have low internal leakage.

R<sub>1</sub> — 1000 ohms, 1 watt.

R<sub>2</sub> — 500,000-ohm variable resistor.

X<sub>1</sub> — D.c. relay that will close on the tube plate current — 5–15 ma.

X<sub>2</sub> — 110-volt a.c. relay capable of handling the power circuits to be broken.

B — 4 1/2-volt C battery.

tential of 500 volts or less is required for each lead-in conductor of a receiving station. There are no requirements for indoor antennas, however.

Everyone who owns an amateur station or who plans to have one should send ten cents (not in stamps) to the Superintendent of Documents, Government Printing Office, Washington, D. C., for the booklet *Safety Rules for Radio Installations*, Handbook of the Bureau of Standards No. 9.

## Building a Mast

● It is very rarely that an effective antenna can be erected without putting up some form of mast. And in many cases the mast must be erected and guyed in a restricted space. With the idea of providing some suggestions for the prospective mast-builder, we will present the description of a typical mast. The example selected is a 40-foot mast of simple construction

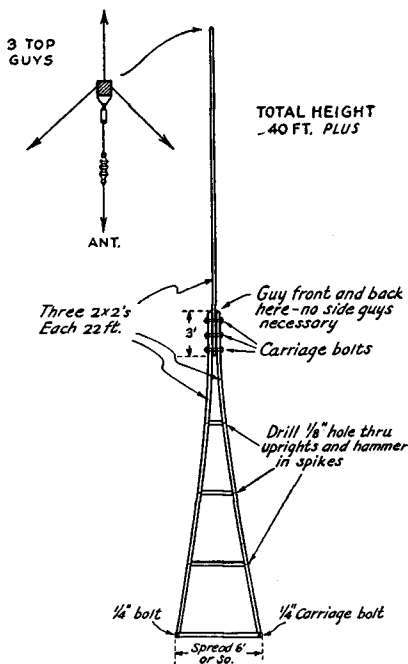

DETAILS OF A 40-FOOT MAST SUITABLE FOR ERECTION IN LOCATIONS WHERE SPACE IS LIMITED

After selecting and purchasing the lumber — which should be straight-grained and knot-free — three sawhorses or boxes should be set up and the mast assembled in the manner indicated in the diagrams. At this stage it is a good plan to give the mast two coats of "outside white" house paint.

After the second coat of paint is dry, attach the guys and rig the pulley for the antenna halyard. The pulley anchorage should be at the point where the top stays are attached so that

the back stay will assume the greater part of the load tension. It is better to use wire wrapping around the stick, with a small through-

base of the mast. The mast in Fig. 1805 was made by bolting an 18 foot  $2\frac{1}{2}$  by  $2\frac{1}{4}$  on a 20-foot 3 by 4. The overlap was 2 feet. Four guys run from the splice to the four corners of the garage. Two back-guys work against the pull of the antenna, but are not at all necessary to support the mast itself.

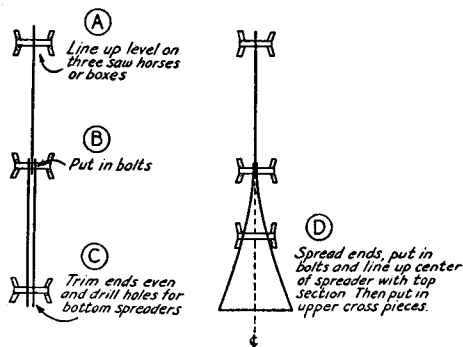

ILLUSTRATING THE METHOD OF ASSEMBLY

bolt to prevent sliding down, than to use eye bolts. The latter weaken the mast.

If the mast is to stand on the ground, a couple of stakes should be driven to keep the bottom from slipping. At this point the mast maybe "walked up" by a pair of helpers. If it is to go on a roof, first stand it up against the side of the building and then hoist it, from the roof, keeping it vertical. The whole assembly is light enough for two men to perform the complete operation — lifting the mast, carrying it to its permanent berth and fastening the guys — with the mast vertical all the while. It is therefore entirely practicable to put up this kind of mast on a small flat area of roof that would prohibit the erection of one that had to be raised vertical in its final location.

Once the base has been placed on its spot and made level right-and-left, the front and back guys from the mid-section are anchored so that the mast stands vertical fore-and-aft. The last step is to anchor the top guys so that the upper section lines up vertical. This can be done quite accurately by sighting up from the bottom, while a helper tightens and loosens guys as commanded.

### A Garage-Top Mast

● In some cases a garage may be used to support a simple mast. The usual two-car garage is 20 feet square. Because of the slope of the roof, the actual effect of guys placed on the diagonals is as if they were but 8 feet from the

Short pieces of guy wire go through the corners of the roof to the scantlings inside and terminate in turnbuckles immediately outside, to which the guys are made fast. A shallow "nest" surmounts the peak of the pyramid and acts as a footing for the mast; it holds itself in place without fastening.

The mast, with guys attached, is stood up against one side of the garage. A "cattle-walk" is then temporarily laid down on one slope of the garage and lashed in place. A ladder is leaned against the side of the garage alongside the mast, its upper end reaching to the "cattle-walk." With four fellows to hold the lower guys (the upper back-stays dangling loose), two fellows on the roof can readily lift the mast vertically hand over hand, it being rested on the rungs of the ladder while fresh grips were taken. With the foot of the mast lifted to the

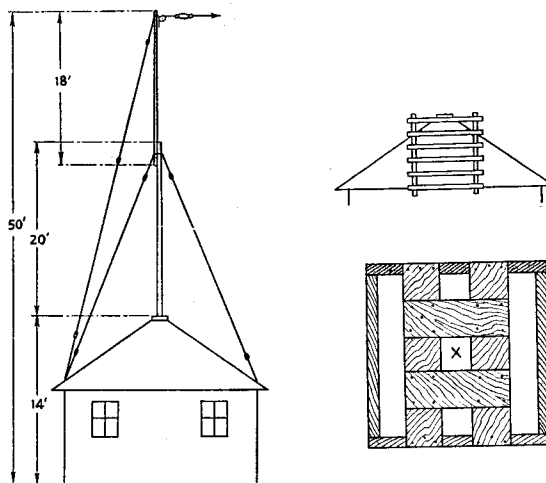

FIG. 1805 — ANTENNA MAST ON TOP OF A TWO-CAR GARAGE

Details of the mast socket and the placing of the "cattle-walk" for erecting the mast are shown.

edge of the roof, it is then a simple matter to walk it, a foot at a time, up the "cattle-walk" and place it in its step, the guys meanwhile supporting it.

The antenna halyard runs through the garage roof at the base of the mast, thence over two pulleys to a counterweight.

# 19

## *Operating a Station*

**T**HE enjoyment of our hobby comes from the operation of our station once we have finished its construction. Upon the *station* and its *operation* depend the traffic reports, DX, and communication records that are made. We have taken every bit of care that was possible in constructing our transmitter, our receiver, frequency measuring and monitoring equipment and in erecting a suitable antenna system. Unless we make ourselves familiar with uniform standard operating procedure, unless we use good judgment and care in operating our stations, we shall fall far short of realizing the utmost in results achieved. More than this, we may make ourselves notorious unless we do the right thing, because we may interfere with other stations or delay their work.

After some listening-in experience you will hear both kinds of operators and realize the contrast that exists between the operation of the good men and that of "lids" and "punks" who have never taken the trouble to familiarize themselves with good practice. Occasionally you will pick up an amateur whose operating is so clean-cut, so devoid of useless efforts, so snappy and systematic, that your respect is gained. It is a pleasure to listen and work with him. On the other hand the operator who sends forty or more CQ's and signs two or three times in a slipshod manner gains the respect of no one. His call may be impossible to identify. His lack of operating judgment seriously impairs and handicaps *his own success and enjoyment* in addition to causing other amateurs to form an unfavorable opinion of his work and the uncalled-for interference he creates. By *proper* procedure the number of two-way contacts (QSO's) and the enjoyment and profit in each will be a maximum.

For most efficient operation, the transmitter should be adjusted for satisfactory, stable, operation *on one frequency* in the amateur band. Use of quartz crystal control helps to insure close adherence to one frequency and gets results when once a dependable arrangement has been installed. With self-controlled sets known condenser settings to approximate certain frequencies will make it possible to change

location in the band slightly to get around interference if necessary. But when such a change is made take no chances; always check frequency with care for there is *no* good excuse for off-band operation. Calibrations of the station frequency standard should be checked at least once a month by A.R.R.L. standard frequency transmissions to guard against variations, and daily comparison with dependable stations assigned channels adjacent to our bands is desirable. Do not try to work too near the edge of an amateur band. Keep well *within* the estimated accuracy of your frequency measuring equipment and means of measurement. Check frequency often.

The operator and his methods have much to do with limiting the range of the station. The operator must have a good "fist." He must have patience and judgment. Some of these qualities in operating will make more station records than many kilowatts of power. Engineering or applied common sense are as essential to the radio operator as to the experimenter. Do not make several changes in the set hoping for better results. Make one change at a time until the basic trouble or the best adjustment is found. The quality of operating ability is just as essential and important in radiotelephone operating work.

An operator with a clean-cut, slow, steady method of sending has a big advantage over the poor operator. Good sending is partly a matter of practice but patience and judgment are just as important qualities of an operator as a good "fist."

Too often the beginner-operator operates his set like a plaything; the aim should be to operate with a serious and constructive purpose, not for novelty or mere entertainment. It must be remembered that radio communication is not an individual "plaything" but the interference one causes may affect many others. It may cause pleasure or expressions of annoyance depending on the care and thoughtfulness with which one operates. All of this merely to introduce the plea that time be given to the brief study of operating technique before going on the air.

The good operator sends signals which are

not of the "ten words per minute" variety, but they are slow enough so that there is no mistaking what he says. The *good* operator does not sit down and send a long call when he wants to work someone. He *listens in*. He covers the dial thoroughly. The fellow that is admired for his good operating is the one who is always calling some particular station instead of using the "inquiry signal." Because he *listens* until he hears someone to work and *then* goes after him, our good operator gets his man nearly every time. A good operator chooses the proper time to call, he makes plain signals, and he does not call too long. A short call is sufficient because if a station does not get the call it is likely that he is listening to another station. A long call makes the receiving operator lose patience and look for someone else.

The adjustment on the receiver has much to do with successful operation, too. The good receiving operator notes the dial setting and when he has completed calling in proper fashion, he waits a moment and then tunes above or below the logged dial setting just in case something has shifted slightly in the receiver or transmitter. The best operator has patience and waits a few minutes in case of delay at the transmitter or in case fading signals make a second answer necessary.

## Communication

● After all, communication has as its object the exchange of thought between two minds. Sometimes those minds are near each other and it is possible for the individuals concerned to converse at length and exchange their thoughts freely. At other times, and this when radio

communication is involved, the individuals are miles apart and the thoughts to be transmitted must be condensed to just a few words. Then these words must be relayed or passed on from operator to operator. When they reach their ultimate destination someone can interpret them fully if they have been properly and carefully handled by the intermediate operators.

Time is involved in making any exchange of thought. Because every man's life and experience is measured by time, this factor becomes important in everything we do or say. The number of messages handled, the number of distant stations worked, the number of records made at our station, all depend in some degree on the time available for our hobby. The more time we spend at the set, the more well known our station becomes and the more extensive will be the sum total of our results in amateur radio.

As time is a factor, uniform practices in operating have become necessary to insure a ready un-

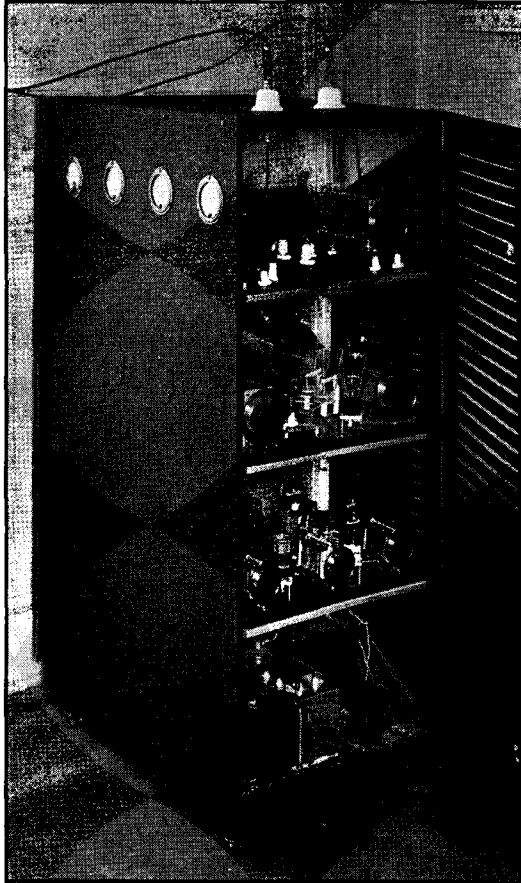

ONE OF THE TRANSMITTERS AT W1NPF, STATION OF THE A.R.R.L. HEADQUARTERS' OPERATORS' CLUB

*This completely self-contained transmitter is located at the West Hartford office of the League where club member-operators may drop in conveniently for operation in the noon hour or at other times. The four transmitter sections shown are (bottom to top) power supply, exciter (2A5 (2) 2A5's (2) 801's, two 800's (the driven stage), and at top the antenna coupling unit. On the other side of the equipment housing is another power supply, the modulator (800's), the speech amplifier, relays, and protective equipment. Crystal-switching is provided with crystals for either voice or telegraph operation. Another photograph in this Chapter shows the operating position.*



## Operating a Station

standing of what is going on in the minds of each operator. "Q" signals and abbreviations of various sorts have been devised and are in general use to-day just because of the time element involved, to enable every operator to exchange intelligible thoughts with as little waste effort as possible. So proficiency in the commonly-used abbreviations and in knowledge of uniform operating practices is to be desired. Proficiency comes with practice. In the Appendix are the "Q" signals and some abbreviations used by amateur operators.

*Accuracy is of first importance.* Then *speed* in transmission and handling of radiograms must be considered. Very often, transmission at moderate speeds moves traffic more quickly than fast sending. A great deal depends on the proficiency and good judgment of the two operators concerned. Fast sending is helpful only when two fast operators work together.

### Procedure

● Official Relay Stations and Official Phone Stations conform in their operating procedure to definite high standards which are mentioned on the appointment certificate. Some specific rules and regulations have been made to raise the standard of amateur operating. Official A.R.R.L. Stations observe the rules regarded as "standard practice" carefully.

Any actively-operating stations will do well to copy these rules, to post them conspicuously in the station, and to follow them when operating.

1. The calling station shall make the call by transmitting not more than three times the call signal of the station called and the word DE, followed by its own call signal sent not more than three times, thus: VE2BE VE2BE VE2BE DE W1INF W1INF W1INF. In amateur practice this procedure may be expanded somewhat as may be necessary to establish communication. The call signal of the calling station *must* be inserted at frequent intervals for identification purposes. Repeating the call signal of the called station five times and signing not more than

twice (this repeated not more than five times) has proved excellent practice in connection with break-in operation (the receiver being kept tuned to the frequency of the called station). The use of a break-in system is highly recommended to save time and reduce unnecessary interference.

Stations desiring communication, without, however, knowing the calls of the operating station within range, may use the signal of inquiry CQ, in place of the call signal of the station called in the calling formula. The A.R.R.L. method of using the general inquiry call (CQ) is that of calling three times, signing three times, and repeating three times. CQ is not to be used when testing or when the sender is not expecting or looking for an answer. After CQ, the dial should be covered thoroughly for two or three minutes looking for replies.

The directional CQ: To reduce the number of useless answers and lessen QRM, every CQ call shall be made informative when possible. Stations desiring communication shall follow each CQ by an indication of direction, district, state, continent, country or the like. Stations

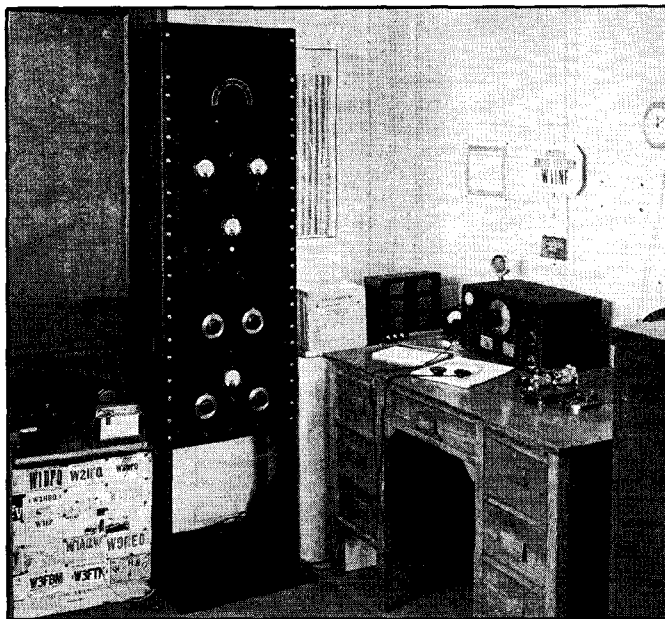

W1INF AT HEADQUARTERS

*The control position at W1INF (for W1MK) is located in the Communications Department at Hq. The transmitter shown above is one of those rebuilt after the floods of '36. At the left is the "automatic fist" used in sending messages addressed "to all radio amateurs." Synchronous motor drive is used to insure absolute constancy in speed. Clock and schedule lists are immediately before the operator. Other features are crystal keying for break-in, accessibility of controls and crystal-switching for flexibility.*

# The Radio Amateur's Handbook . . . . .

desiring communication with amateur stations in a particular country shall include the official prefix letters designating that country after each CQ. The city, state, point of the compass, etc., is mentioned and the thrice-repeated station call. International prefixes (Appendix) may be used to identify a particular country. Examples follow. A United States station looking for any Canadian amateur calls: CQ VE CQ VE CQ VE DE W1UE W1UE W1UE K. A western station with traffic for the east coast when looking for an intermediate relay station calls: CQ EAST CQ EAST CQ EAST DE W5CEZ W5CEZ W5CEZ K. A station with messages for points in Massachusetts calls: CQ MASS CQ MASS CQ MASS DE W8KKG W8KKG W8KKG K. In each example indicated it is understood that the combination used is repeated three times.

2. Answering a call: Call three times (or less); send DE; sign three times (or less); and after contact is established decrease the use of the call signals of both stations to once or twice. Example. W1GNF DE W1MK GE OM GA K (meaning, "Good evening, old man, I am ready to take your message, go ahead").

3. Ending signals and sign off: The proper use of AR, K and VA ending signals is as follows: AR (end of transmission) shall be used at the end of messages during communication and also at the end of a call, *indicating when so used that communication is not yet established*. In the case of CQ calls, the international regulations recommend that K shall follow. K (invitation to transmit) shall also be used at the end of each transmission *when answering or working* another station, carrying the significance of "go ahead." VA (or SK) shall be used by each station only when signing off, this followed by your own call sent once for identification purposes. VA (end of work) sent alone, or for clarification followed by a single (never more) "CQ DE - - -," indicates to others that you are through with the station which you have been working and will listen for whomever wishes to call. Examples:

(AR) G2OD DE W1AQD AR (showing that W1AQD has not yet gotten in touch with G2OD but has called and is now listening for his reply). Used after the signature between messages, it indicates the end of one message. There may be a slight pause before starting the second of the series of messages. The courteous and thoughtful operator allows time for the receiving operator to enter the time on the message and put another blank in readiness for the traffic to come. If K is added it means that the operator wishes his first message acknowl-

edged before going on with the second message. If no K is heard, preparations should be made to continue copying.

(K) ZL2AC DE W6AJM R K. (This arrangement is very often used for the acknowledgment of a transmission. When anyone overhears this he at once knows that the two stations are in touch, communicating with each other, that ZL2AC's transmission was all understood by W6AJM, and that W6AJM is telling ZL2AC to go ahead with more of what he has to say.) W9KJY DE W3EZ NR 23 R K. (Evidently W9KJY is sending messages to W3EZ. The contact is good. The message was all received correctly. W3EZ tells W9KJY to "go ahead" with more.)

(VA) R NM NW CUL VY 73 AR VA W7WY. (W7WY says "I understand OK, no more now, see you later, very best regards. I am through with you for now and will listen for whomever wishes to call W7WY signing off.")

4. If a station sends test signals to adjust the transmitter or at the request of another station to permit the latter to adjust its receiving apparatus, the signals must be composed of a series of V's in which the call signal of the transmitting station shall appear at frequent intervals.

5. When a station receives a call without being certain that the call is intended for it, it shall not reply until the call has been repeated and is understood. If it receives the call but is uncertain of the call signal of the sending station, it shall answer using the signal - - - - - (?) instead of the call signal of this latter station. QRZ? (see Appendix) is the appropriate signal to use, followed by your call to ask who is calling and get this station to call again.

6. Several radiograms may be transmitted in series (QSG . . . . .) with the consent of the station which is to receive them. As a general rule, long radiograms shall be transmitted in sections of approximately fifty words, each ending with - - - - - (?) meaning, "Have you received the message correctly thus far?"

7. A file of messages handled shall be kept, this file subject to call by the Section Manager at any time at his discretion. Only messages which can be produced shall be counted in the monthly reports, and these under the A.R.R.L. provisions for message-counting.

Above all, the operator will *never make changes or alterations in the texts or other portions of messages passing through his hands*. However slight or however desirable such changes may seem, the changing of a message without proper authority or without the

knowledge of the originator of the message may be considered the "unpardonable sin." The proper thing to do of course is to notify the party filing the message or the originating station of your observations, secure permission from the proper source for making the change by sending a "service message" or other means. If the case seems urgent, the traffic should not be delayed but should be delivered or forwarded with appropriate notation or service accompanying it.

In acknowledging messages or conversation: Never send a single acknowledgment until the transmission has been successfully received. "R" means "All right, OK, I understand *completely*." When a poor operator, commonly called a "lid," has only received part of a message, he answers, "R R R R R R R R R R, sorry, missed address and text, pse repeat" and every good operator who hears, raves inwardly. Use R *only* when *all* is received correctly.

Here is the proper procedure to follow when a message has been sent and an acknowledgment is requested. When all the message has been received correctly a short call followed by "NR 155 R K" or simply "155 K" is sufficient. When most of the message was lost the call should be followed by the correct abbreviations (see Appendix) from the international list, asking for a repetition of the address, text, etc. (RPT ADR AND TXT K). When but a few words were lost the last word received correctly is given after ?AA, meaning that "all after" this should be repeated. ?AB for "all before" a stated word should be used if most of the first part of the copy is missing. ?BN . . . . . AND . . . . . (two stated words) asks for a fill "between" certain sections. If only a word or two is lost this is the quickest method to get it repeated.

Do not send words twice (QSZ) unless it is requested. Send single unless otherwise instructed by the receiving operator. When reception is very poor, a QSZ can be requested to help make better copy. When conditions are even moderately fair, a QSZ is unnecessary. Few things are as aggravating as perfect transmission with every word coming twice. Develop self-confidence by not asking others to "QSZ" unless conditions are rather impossible. Do not fall into the bad habit of sending double without a request from fellows you work.

*Do not accept or start incomplete messages.* Omission of the fundamental parts of a message may keep a message from getting through to its destination. Official Relay Station appointments are subject to cancellation for failure to make messages complete enough.

#### Activities — Contests

● Operating in the amateur bands offers many thrills. Routine communication is possible, but even the most consistent and reliable communication by amateur radio is not at all limited to routine. The "unexpected" is always around the corner. A pleasant experience may arrive in the form of unusual DX, a renewed friendship over the air, a chance to render message service in some special case, or a sudden communication emergency in which one may play a part.

Special activities are sponsored by the American Radio Relay League, adding to ham interest and fraternalism at the same time opportunity is given for testing station performance over definite periods, making new friendships and QSOs, and developing operating technique. A.R.R.L. also cooperates with foreign amateur societies in many jointly publicized programs for the operating man that have similar beneficial aims.

Contest activities are diversified as greatly as possible to appeal to every classification of amateur interest showing a desire to participate. Several contests have grown greatly from year to year, being modified only slightly in character from time to time in accordance with suggestions and expressions from amateurs. Probably the most well known of all are the annual Sweepstakes, and the DX contests, which are open to every ham and carry an appeal to nearly all groups.

Within the A.R.R.L. field organization (in which there are appointments open to every amateur, specified lines of work in ham radio for those with the qualifications) there are monthly and quarterly activities that play an important part in making ours a real radio fraternity. The first Saturday night of each month is the time set aside for *all* A.R.R.L. officials, officers and Directors to get together over the air from their own stations, wherever located. This work is carried out mainly in the 3.5-mc. band. The first Saturday night in each month is known to the gang generally as RM NITE because this get together started as a gathering of Route Managers only, the number of RMs exceeding somewhat the number of other officials. The basic appointments of Official Relay Station and Official Phone Station include several times as many individual operators as there are A.R.R.L. officials of course. Special activities are scheduled quarterly for the ORS-OPS appointees, these having something of the character of an operators' competition to test stations and develop operating ability. At the same time, every appointee gets a chance to chat as formally or in-

# The Radio Amateur's Handbook . . . . .

formally as he likes with his Section Manager, Phone Activities Manager, Route Manager, or perhaps with A.R.R.L. Headquarters men or League Directors all of whom have come to look forward to these get togethers. The qualifications of both O.R.S. and O.P.S. are such that these groups are at all times made up of only the keenest and most active operators. The quarterly QSO Parties held on a Saturday-Sunday in late January, April, July and October assist in testing out stations, developing equipment, and maintaining fraternalism at the same time all participating operators keep themselves in readiness for either routine or emergency operating with the true A.R.R.L. spirit of preparedness.

It may be interesting to review briefly the general activities of a typical "full" season, for what sort of a program is offered to every A.R.R.L. member — this in addition to the first-Saturday-night official schedule, and the quarterly ORS/OPS doings, of course.

With the start of the radio season in October, we customarily take part in a VK-ZL (Australia-New Zealand) Contest, operating each week-end of that month to make as many two way contacts with VK's and ZL's as possible. Many new stations can be worked. This contest is announced in cooperation with the Wireless Institute of Australia, and as with all activities, rules are given in the current issue of *QST*, distributed on this continent just before the activity opens. The annual Navy Day Receiving Competition is managed by the A.R.R.L. in late October, an opportunity for any receiving ham to check his copying ability and proficiency by getting the telegraphic dispatches sent from NAA and NPG to amateurs on the occasion of Navy Day, October 27th. An "honor roll" in *QST* and letters of commendation to the most proficient, follow the running off of this event.

One of the very biggest events of the year is the annual Sweepstakes Contest, or National A.R.R.L. QSO Party which has potentialities of operating fun and new QSOs for everybody, the operation extending to all bands. Each November the rules for this are announced, again with A.R.R.L. certificate awards in each W and VE Section in the League's Field Organization. A large number of contacts, new stations, new Sections and other operating records are always reported in and after the "SS" and the spirit of fraternalism prevails. The magic key to open the door to QSOs, new and old, during the Sweepstakes is a CQ SS, sent in a snappy manner, by any ham, anywhere in the 69 A.R.R.L. Sections.

In November of national election years

results have been addressed "to all radio amateurs" through the A.R.R.L. Hq. Station, tape telegraph transmissions making it possible to copy and record the figures progressively during the evening of election day. This, like other "special" transmissions "to A.R.R.L. members" on our own Director elections, supplements the weekly messages of amateur radio activities and regulatory matters which any amateur can pick up direct on his own high frequency receiver.

In December for the last two or three years a Copying Bee has been arranged. The League offers a silver loving cup award to the most proficient. Unusual word and figure combinations are transmitted at a fairly rapid speed by tape transmitters from three or four of the more powerful amateur stations throughout the country. Note the schedules in December *QST* and report your copy from one of these stations to A.R.R.L. Coöperative announcements of operating arrangements with other societies are often made for December and January, also.

In February, Transcontinental relays, and 'phone-c.w. QSO Parties have been held. DX men prepare during February for A.R.R.L.'s March DX contest, and members located in British dominions take part in the R.S.G.B.'s "B.E.R.U." week-end DX doings.

Every year, in March, comes the annual A.R.R.L. International Relay Competition, or DX Contest, an activity in which W/VE amateurs invite all the world to take part with them. Serial numbers are exchanged as proof of QSOs. New countries, new continents, etc., are worked and many new W.A.C. certificates are awarded annually after the 9-day activity (usually provided with a 90-hour-total-time limit) is over. The QSL-bureaus of the world are also taxed by the annual flood of DX confirmations exchanged by hams after their operating in this DX free-for-all is over. The interest in the DX QSO's made possible is evidenced every year by stacks of logs several feet deep, and hundreds of course enjoy the DX made possible, even without submitting logs. Every ham looks forward eagerly to the full DX report in *QST* which shows his report compared with the others submitted.

The VE/W (Canada-United States) Contact Contest is a chance to see which U. S. A. ham can work most of our Canadian brothers, and vice versa. This is sponsored by the C.G.M. and a Canadian Committee and League certificate awards are made to the winners in each A.R.R.L. Section. Formerly scheduled for fall, it is now expected that it will be announced as an April activity for the coming season.

Last, but by no means least, on the League's operating program, is the annual A.R.R.L. Field Day which ordinarily is held on a weekend in June, combining the out-of-door opportunities with the Field testing of portables. As in all our operating, the idea of having a good time is combined with the more serious thought of preparing ourselves to shoulder the communication load as emergencies turn up and the occasion requires. A premium is placed on the use of low or medium power, on portability, and on the use of equipment without connection to commercial sources of power supply. Clubs and individual groups always have a good time, learn much about the requirements for knock-about conditions afield, and achieve success in testing equipment carefully built or quickly thrown together to suit the needs of the occasion. An additional "F.D." in August has been announced of late years due to the popularity of the idea and demand for a second summer party.

### Operating Notes

● A sensitive receiver is often more important than the power input in working foreigners. There is not much difference in results with the different powers used, though a 250-watt will probably give 10% better signal strength at the distant point than 50 to 100 watts or 10's, other factors being the same. It will not do much better than this because the field strength drops so rapidly as we get away from the antenna. In working foreign countries and DX stations you should be able to hear ten or a dozen stations before expecting that one of them will hear you call.

Conditions in the transmission medium make all field strengths from a given region more nearly equal at a distance, irrespective of power used. In general, the higher the frequency band, the less important "power" considerations become.

Hams who do not raise DX stations readily may find that (a) their sending is poor, (b) their calls ill-timed or judgment in error. It is usually *wasted effort* for W/VE stations to send CQ DX. When conditions are right to bring in the DX, and the receiver sensitive enough to bring in several stations from the desired locality, the way to raise DX is to use the appropriate frequency and to *call these stations*. Reasonably *short* calls, with appropriate and brief breaks to listen will raise stations with minimum time and trouble. The reason W/VE CQs do *not* raise DX is that the number of U. S. A. and Canadian hams is so great that it is always possible for a foreign station to find a large number of W/VE's calling, without wasting

time on stations not definitely looking for this station.

The signal "V" is sometimes sent for two to five minutes for the purpose of testing. When one station has trouble in receiving, the operator asks the transmitting station to "QSV" while he tries to adjust his receiving set for better reception. A decimal point is often sent by the letter "R." Example: 2.30 PM is sent "2R30 PM." A long dash for "zero" and the Morse C (.. .) for "clear" are in common use. Figures are best spelled out in texts, for highest accuracy. An operator who misses directions for a repeat will send "4," meaning, "Please start me, where?" These latter abbreviations, like others in our present-day practice, are hybrids, originating in wire practices and Morse usages.

Improper calling is a hindrance to the rapid dispatch of traffic. Long calls after communication has been established are unnecessary and inexcusable. Some stations are slow to reply to a call. However, the day of the station with dozens of switches to throw is past. Controls for both receivers and transmitters are simpler, fewer in number, and more effective. The up-to-date amateur station uses a "break-in" system of operation and just one switch controlling the power supply to the transmitter.

Poor sending takes the joy out of operating. There are stations whose operators are not able to send better and those who can send better but do not. The latter class believe that their "swing" is pretty. Some use a key with which they are not familiar.

Beginners deserve help and sympathetic understanding. Practice will develop them into good operators. The best sending speed is a medium speed with the letters quickly formed and sent evenly with proper spacing. The standard type telegraph key is best for all-round use. Before any freak keys are used a few months should be spent listening-in and practicing with a buzzer. Regular daily practice periods, two or three half hour periods a day, are best to acquire real familiarity and proficiency with code.

No excuse can be made for a "garbled" text. Operators should copy what is sent and refuse to acknowledge messages until every word has been received correctly. *Good operators never guess* at anything. When not sure of part of a message they ask for a repeat. The "lid" operator can be told very quickly when he makes a mistake. He does not use a definite "error" signal and go on with his message but he usually betrays himself by sending a long string of dots and nervously increasing his rate of sending. The good operator sends "?"

# The Radio Amateur's Handbook . . . . .

after his mistakes and starts sending again with the last word sent correctly. Unusual words are sent twice; "?" is sent and then the word repeated for verification.

The law concerning superfluous signals should be noted carefully by every amateur. Some operators hold the key down for long periods of time when testing or thinking of something to send. Whenever this is done during operating hours, someone is bothered. Unnecessary interference prevents someone from getting in contact with (QSO) someone else, and if messages are being handled the copy is ruined. If you must test, disconnect the antenna system and use an equivalent "dummy" antenna (made of lumped resistance, capacity and inductance). Always send your call frequently when operating with the antenna. Pick a time for adjusting the station apparatus when few stations will be bothered.

## Using a Break-In System

● A break-in system of operation makes it possible for us to interrupt the other fellow if we miss a word or do not understand him. With a telephone we stop talking as soon as the distant party speaks and interrupts us. In a telegraph office the operator who misses a word opens his key so that the sending is interrupted and cannot go on until the receiving operator has had his say and again closed the circuit. In a radio system using break-in the receiving operator presses the key and makes some long dashes for the transmitting operator to hear. As soon as he gets the signal he stops transmitting and listens to what the receiving operator says, before resuming sending.

A separate receiving antenna makes it possible to listen to most stations while the transmitting tubes are lighted. It is only necessary with break-in to pause just a moment occasionally when the key is up (or to cut the carrier momentarily and pause in a 'phone conversation) to listen for the other station. Appreciation of the many advantages should make the use of break-in wide-spread for *both* voice and code work.

Useless calling and unnecessary transmission during periods of heavy QRM can be prevented through intelligent use of break-in. Long calls, for example, are inexcusable, inconsiderate and unnecessary. Every transmitter can be so arranged that by lifting the key (and connecting 'phones to the receiver if these are cut off during transmission) the operator can ascertain if the station called is replying. Brief calls with frequent short pauses to listen for replies constitute intelligent operating, devoid of useless effort. During c.w. transmissions insert

a "BK" and pause briefly at intervals. This makes it possible for the other operator to stop you, or get fills, if necessary. If not, transmission may be resumed. If you find that the station you are calling has, in the meantime, connected with another amateur instead of answering your call you will have at least saved yourself some wasted effort. QRM will also be lessened thereby. If the operators understand that break-in is being used, a "bk" and "g.a." will be of greatest value to interrupt transmission and direct when it shall be resumed. Where voice is being used similarly, conversations resemble wire telephone communication, and flow smoothly from subject to subject, and the "click" noted when the carrier is cut off momentarily can be as effective as the word "break" (so this can be eliminated) when two operators experienced in this mode of operating use this improved system of operation.

The faster the change from transmitting to receiving can be engineered the better. A Morse-wire type key with a switch on the side, in series with either the filament center-tap (cathode) of the oscillator stage, or in the negative high voltage supply can be used for *voice* break-in. (There must be enough fixed bias on amplifier stages to keep the plate current low when r.f. excitation is nil, and h.v. on, of course.) If there is audio feed-back from speaker to microphone, head-phones should solve the problem, or if desired a relay can be used to short the microphone transformer. A push button to put the carrier on the air only while talking is a completely practical device, and amateur 'phone operators would do well to emulate the push-to-talk efficiency of the Airways operators to improve conditions in the 'phone bands.

C.w. *telegraph* break-in is usually simple to arrange. With break-in, ideas and messages to be transmitted can be pulled right through the holes in the QRM. Snappy, effective, efficient, enjoyable amateur work really requires but a simple switching arrangement in your station to cut off the power and switch 'phones from monitor to receiver. If trouble occurs the sending station can "stand by," (QRX) or it can take traffic until the reception conditions at the distant point are again good.

In calling, the transmitting operator sends the letters "BK," "BK IN," or "BK ME" at frequent intervals during his call so that stations hearing the call may know that a break-in is in use and take advantage of the fact. He pauses at intervals during his call, to listen for a moment for a reply from the station being called. If the station being called does not answer, the call can be continued. If the station

# Operating a Station

called answers someone else, he will be heard and the calling can be broken off. When two stations are using break-in, they can interrupt each other at any time when something goes wrong or a letter is dropped, and traffic can be handled in half the usual time. There is a real "kick" from working a break-in arrangement.

## Keeping a Log

● Every operator of an amateur station must keep a log of the operating work that is done; it should cover, as well, the tests of an experimental nature that are carried out with the transmitter or receiver.

The well-kept log is invaluable in checking up reports of any nature concerning amateur station operation. It contains positive evidence of every transmission. It is a permanent record of the achievements of the station. The Federal Communications Commission obliges every amateur station to maintain an accurate log of the time of each transmission, the station called, the input power to the last stage of the transmitter, the frequency band used, the time of ending each QSO and the operator's personal "sine" for each session of operating. So, in addition to other excellent reasons for log-keeping, the regulations make a complete record of transmitting activity compulsory.

A loose-leaf notebook can be used. The sheets can be renewed each month and those used can be taken out and filed away with the cards and station records. A stenographer's ordinary notebook costing from ten to thirty cents and about 4½" by 8½", takes little space on the operating table and also makes a good log book. If simplicity and low cost are the only considerations, such a modified notebook-log is recommended.

A dozen pages may be ruled in advance with vertical lines. In the first column the date and times are noted. In the second column the calls of stations worked, heard, and called are put down. A circle, parentheses, or a line drawn under the call can indicate whether a station was worked, heard and called, or simply heard. A special designating sign or abbreviations before or after the call letters can show this information. Provision must be made for entering the power, the time of ending QSOs, and the frequency band used. *W*, *H*, and *C* can be used for "worked," "heard" and "called."

Most amateurs find it more convenient to get an inexpensive ready-made log, instead of going to the trouble to rule the home brewed variety. In keeping a log, power and frequency can be written across the page, or in the page heading, new entries being made only when these are changed. The dial settings of receiver

or frequency meter may be entered in logging stations so that we can come back to these same stations without difficulty when desired.

Figure 1 shows the official A.R.R.L. log. The first entry for each watch is that for the date and time. Greenwich Civil Time is the logical reference standard but local standard time is easiest to use to avoid confusion and so this is used by most amateurs; *PST*, *MST*, *CST*,

AMATEUR RADIO STATION LOG											
Date power to last stage, _____ watts		Frequency, _____ Mcs.		Approximate location: _____		Type of antenna or mobile use in which installed: _____					
DATE TIME	STATION CALLED	BY	STATION HEARD	IF GOOD RESULTS	REMARKS	CHANGES FROM PREVIOUSLY RECORDED DATA, ETC.	PREVIOUSLY RECORDED DATA, ETC.	PREVIOUSLY RECORDED DATA, ETC.	PREVIOUSLY RECORDED DATA, ETC.	PREVIOUSLY RECORDED DATA, ETC.	PREVIOUSLY RECORDED DATA, ETC.
7:45 PM	W7TH	X	5 7 6	5 7 9	6:45 PM	None open!					
8:08	W7SEP	X	5 7 9			No copy					
6:16	W7LH	W7NH				W7LH says they'll be on show!					
6:37	W7ESA	X	4 6 9	5 6	6:17:12	Banner, Colo.					
7:28	CQ	X									
7:28	X	W7RDE	3 4 9		5 3 9	7:35	Too early for 7:30 sign-out				
7:45	off for evening										
7:53 AM	W7ARS	X			7:30 AM	None					
7:51	X	W7RGO			7:53	Closed above ARS					
8:01	CQ	X									
8:25	W7PES	X	6 9 9	5 7 9	8:31	W7PES at Key, there					
8:40	CQ	W7DMA	5 7 9			Summer sign!					
8:10 PM	CQ	X									
6:15	X	W7ACM	5 7 9		6:24 PM	Trans Line Station					
6:32	W7GXM	X			6:59	San Angeles					
7:00	GRY	—									

FIG. 1

**KEEP AN ACCURATE AND COMPLETE STATION LOG AT ALL TIMES! THE F.C.C. REQUIRES IT**

The official A.R.R.L. log is shown above, answering every government requirement in respect to station records. Bound logs made up in accord with the above form can be obtained from Headquarters for a nominal sum or you can prepare your own, in which case we offer this form as a suggestion, hoping that you find it worthy of adoption. Every station must keep some sort of a log. The above log has a special wire binding and lies perfectly flat on the table.

*EST*, *GCT*, etc., is entered in the heading of the first column in the A.R.R.L. log and then the date which corresponds to that kind of time is put in the first space below the heading, and time entries on the first vacant line below that, those to be entered progressively until a change in date.

*CW* and *F* (or *P*) can be used in the leading to distinguish between your use of c.w. telegraphy and radiophone operation; or *A1*, *A2*, or *A3* standing for c.w. telegraphy, c.w. telegraphy modulated at audible frequencies, and radio telephony (speech), respectively.

Log users will quickly adopt certain convenient practices which simplify the keeping of a log such as use of an *X* for one's own call signal, to save time in making the entries. When several stations answer a *CQ*, each should be listed in the third column following your own call signal in the second column. Any unusual data requiring explanation, such as an interrupted or incomplete contact due to power line failure, local interference, etc., should go in the "remarks" column. Also a detailed record

# The Radio Amateur's Handbook . . . . .

of messages exchanged should be entered. This last column should show the "sine" of a new operator taking the key, remarks, message notations, changes from previously recorded (heading) information, etc. Special provision is made in the A. R. R. L. log, for recording signal reports, and the time of ending each QSO as required by the F. C. C. Entries in this column at once show which stations were "worked" without special indications of C, W, or H being necessary. Special columns for recording "messages handled" and for easily keeping track of acknowledgment cards sent and received are a part of the official A. R. R. L. log.

Left-hand pages in the log may be left blank to use for extensive remarks on emergencies or expeditions, for diagrams, records of tuning adjustments and ranges, or changes in equipment.

A log is of great value in a number of additional ways through use of these left-hand pages. A comparison of the operating results obtained with different apparatus in use at different times is valuable. The "DX" or traffic-handling value of the various frequencies over varying distances may be readily found from the log. The effect of weather or time of day may be also quickly found. Every change made in either the transmitter or antenna system should be noted down in the log so that results may be compared for dates before and after the date when a change was made. No matter how trivial the change, put it down in the log. Remember that only one change at a time should be made if the changed results are to be attributed to one definite cause.

## Word List for Accurate Transmission

● When sending messages containing radio calls or initials likely to be confused and where errors must be avoided, the calls or initials should be thrown into short code words:

A — ABLE	J — JIG	S — SAIL
B — BOY	K — KING	T — TARE
C — CAST	L — LOVE	U — UNIT
D — DOG	M — MIKE	V — VICE
E — EASY	N — NAN	W — WATCH
F — FOX	O — OBOE	X — X-RAY
G — GEORGE	P — PUP	Y — YOKE
H — HAVE	Q — QUACK	Z — ZED
I — ITEM	R — ROT	

Example: *W1BCG* is sent as *WATCH ONE BOY CAST GEORGE*.

A somewhat different list can be obtained from the local Western Union telegraph office and posted beside the telephone to use when telephoning messages containing initials and difficult words. Such code words prevent errors due to phonetic similarity. Here is the Western Union word-list:

A — ADAMS	J — JOHN	S — SUGAR
B — BOSTON	K — KING	T — THOMAS
C — CHICAGO	L — LINCOLN	U — UNION
D — DENVER	M — MARY	V — VICTOR
E — EDWARD	N — NEW YORK	W — WILLIAM
F — FRANK	O — OCEAN	X — X-RAY
G — GEORGE	P — PETER	Y — YOUNG
H — HENRY	Q — QUEEN	Z — ZERO
I — IDA	R — ROBERT	

## 'Phone Procedure

● Amateur radiophone stations should use the international radiotelephone procedure which is part of the supplementary regulations to the International Radiotelegraph Convention.

For spelling call signals, service abbreviations and words, such lists as just given should be used.

At the start of communication the calling formula is spoken twice by both the station called and the calling station. After contact is established it is spoken once only. Examples of 'phone procedure in accordance with the International Radiotelegraph Convention:

W5QL calls: "Hello W3JZ Philadelphia, hello W3JZ Philadelphia, W5QL Oklahoma City calling, W5QL Oklahoma City calling, message for you, message for you, come in please."

W3JZ replies: "Hello W5QL Oklahoma City, hello W5QL Oklahoma City, W3JZ Philadelphia answering, W3JZ Philadelphia answering, send your message, send your message, come in please."

W5QL replies, "Hello W3JZ Philadelphia, W5QL Oklahoma City answering, the message begins, from Oklahoma City Oklahoma W5QL number . . . . . [usual preamble, address, text, signature, etc.], message ends; I repeat, the message begins, from Oklahoma City Oklahoma W5QL number . . . . . [repetition of preamble, address, text, signature, etc.], message ends, come in please."

W3JZ replies: "Hello W5QL Oklahoma City, W3JZ Philadelphia answering, your message begins, from Oklahoma City Oklahoma W5QL number . . . . . [repetition of complete message], end of your message, come in please."

W5QL replies: "Hello W3JZ Philadelphia, W5QL Oklahoma City answering, you have the message correctly, you have the message correctly, W5QL Oklahoma City signing off."

Note that in handling traffic by voice, messages are repeated *twice* for accuracy, using the word list to spell names and prevent misunderstandings. The receiving station must repeat the message back *in addition*. Only when the sender *confirms* the repetition as correct can the message be regarded as handled.



# Operating a Station

## Amateur Status

● It is most important that individually and as an organization we be most careful to preserve our standing as amateurs by doing nothing to harm that most precious possession, our amateur status.

No brief can be held for the amateur who accepts direct or indirect compensation for handling specific messages. This is in direct violation of the terms of the amateur station license and the regulations of the Federal Communications Commission.

It is the purpose of these paragraphs to warn amateurs to avoid being "used" by commercial interests in unethical ways. A hotel on the Pacific Coast offered an amateur radio club a fine meeting place with free light, power and heat — provided the amateurs would establish an amateur station and relay messages for guests of the hotel. A certain newspaper planned to "organize an amateur radio club" and establish a "net" for the collecting of amateur news for the paper. It offered the amateurs a club room and the facilities of a powerful station that it would install as a "net control station" in return for the things it could gain by making amateurs violate their amateur status!

There are plenty of legitimate activities in which amateurs may participate. You can render real communication service . . . but *not* for recompense. The League approves amateur coöperation with worthy enterprises, sponsors tests to show the utility of short-wave communication, encourages worth-while service to expeditions in getting their messages from the far parts of the earth. Be assured that there is nothing wrong in accepting trophies in amateur communication contests. Watch carefully and refuse to enter into any agreement or alliances through which you *accept anything* in the nature of a consideration for services rendered in connection with your amateur radio station. There is no question of the good intentions of the amateurs involved in the several cases cited. Very great damage can be done unless there is strict observance of both the spirit and letter of the regulations involving amateur status. Avoid sugar-coated promises and opportunities which might be construed as direct or indirect compensation and a violation of amateur status. Seek competent advice before you jump at chances to get something for nothing. Preserve your most valued possession, your status as an amateur.

Our right to handle friendly communications of worth-while character and to engage in valuable work of all kinds in emergencies and with expeditions remains unquestioned. A

"consideration" of any nature whatsoever absolutely establishes the "commercial" nature of any traffic.

## Emergency Work — QRR

● Amateurs have always given an excellent account of themselves in many emergencies of local and national character. In every instance, the amateurs who have considered the possibilities of an emergency arising *before* the trouble actually came to pass were the ones who must be credited with doing the most important work. They were ready, prepared for the crisis when it came.

Considerations of an emergency power supply are of first importance in many cases where radio is destined to play a part. If local electric service mains are crippled one may have recourse to B batteries, dynamotors driven from storage batteries, and the like. By

### BEFORE EMERGENCIES

Be ready, with really portable sets, and emergency power supply.

Overhaul and test periodically.

Give local officials and agencies your address; explain the availability of amateur radio facilities through your station in emergencies.

### IN EMERGENCY

**CHECK** station operating facilities; offer your services to all who may be able to use them; inform A.R.R.L. an emergency exists, if possible.

**QRR** is the official A.R.R.L. "land SOS," a distress call for emergency uses *only* . . . for use *only* by station asking assistance.

**THE KEY STATION** in emergency zone is the first and the supreme authority for priority and traffic routing in the early stages of emergency relief communications.

**PRIORITY** must be given messages in the general public interest (relief plans, re food, medicine, necessities). Press reports and personal assurance messages can then be handled if practicable.

**COÖPERATION** is required of all amateurs. Don't clutter the air with useless CQs. The majority of amateurs must *listen in*; QRX; avoid QRMing. Be ready to help; operate as intelligently as possible; coöperate by staying off the air while vital first information and relief measures are handled, if stations able to help as well as yours are on the job. (CQ STORM AREA is nothing but "more QRM.")

### AFTER EMERGENCIES

**REPORT** to A.R.R.L. as soon as possible and as fully as possible so amateur radio can receive full credit. Amateur radio communication in 45 major disasters since 1919 has won glowing public tribute. Maintain this record.

# The Radio Amateur's Handbook . . . . .

consulting with other amateurs and putting all the available facilities together in the most favorable location a station can be made operative in short order. An order from some competent authority will make supplies of batteries or temporary service from a public utilities company available for emergency stations. It is sometimes as easy to move the amateur station to a power supply as to collect a power supply together and bring it to the amateur station.

During emergencies it is often possible to send press between the transmissions of relief priority traffic. Invariably such messages are correctly delivered to local member-newspapers in such associations, the public kept informed, and amateur radio credited. Such broadcasts should be sent at regular intervals if possible. They have sometimes been overlooked in the rush. 'Phone has proved itself fine for spot news transmissions which should be specifically addressed to U.P., A.P., N.A.N.A., etc. Local 56-mc. nets should be organized to suit the needs of public utilities, local civil and military authorities and the like. Telegraph links should be established and maintained to points outside stricken areas for handling important officially addressed dispatches for Red Cross and other authorities. Even news transmissions should originate with officials so that responsibility may be properly placed. Be sure all information given out is correct by getting data from responsible sources. Be prepared to "break" Army and Navy circuits on which continuous watches are maintained to get help for your community, if necessary.

Be ready for the emergency call, QRR, when it comes. Jump into the breach with your station if feasible or stand by and avoid interference to those handling emergency traffic if this seems to be the right thing to do. "Standing by" is sometimes the harder but wiser course if the important communications are being handled satisfactorily by others and your traffic is "public correspondence" for individuals.

Make note of the address of railroads, of Red Cross headquarters, of local military units, police departments, representatives of press associations and the like, if possible putting your station on record with such organizations and other competent authorities so that you will be called upon to assist when emergency communication is necessary. When storms approach or disaster threatens it is best to keep in touch with the situation by radio and again to offer service to these agencies well in advance of the actual emergency.

Report in detail direct to A.R.R.L. just what part you and fellow amateurs played. On such reports QST articles are written. *From analysis of all reports A.R.R.L. Public Service Certificates are awarded for notable "public service" work.* Certificates are given in recognition of meritorious work contributing substantially to the service record of the amateur through noteworthy achievement in emergencies, and regular work with expeditions. Report your work!

*Stations outside an "emergency zone" in communication with relief stations in that zone are requested to inform A.R.R.L. Headquarters of this situation by telegram to facilitate traffic movement and for the information of the press.*

## A.R.R.L.'s Emergency Corps — Join Now

● At least one amateur station in every community should be equipped with auxiliary station equipment for use in emergency. For real preparedness such equipment should be designed to operate from power supplies other than the regular a.c. or d.c. lines. Although it is true that much of the most valuable emergency work is done using equipment operating directly from a.c. or d.c. mains, it must be remembered that the "stricken area" itself is usually without current from the power company. "Waits" are inexcusable in emergencies. Communication should be established at the earliest possible moment. To guard against delays the "emergency set-up" must operate from auxiliary power, and the operator must at all times know where he can secure the auxiliary power (if he does not have emergency power himself, arrangements can usually be made with local hardware dealers, radio stores, etc., for the loan of batteries when the need arises).

The "A.R.R.L. Emergency Corps" is divided into two groups: (1) Emergency Powered Stations, (2) the Supporting Division. For membership in the first group it is necessary to possess equipment suitable for operation in an emergency when regular power and communication facilities are disrupted. Auxiliary power must be on hand or must be obtainable from a reliable source upon a few minutes' notice. Membership in the Supporting Division is open to all amateurs who will pledge themselves to assist in the event of failure of regular communication facilities as long as normal power is available; these members do not have to possess auxiliary power, although all members are urged to join the Emergency Powered group at the earliest opportunity.

To join the A.E.C. simply send a postal to the Communications Department, A.R.R.L. (or write for application blank), listing what

## Operating a Station

equipment you have. Applicants for Emergency Powered membership should list carefully all emergency apparatus, especially the auxiliary power facilities. Our annual A.R.R.L. Field Days stress emergency preparation and stimulate development and trial of successful portables also.



MEMBERSHIP CARD, A.R.R.L. EMERGENCY CORPS

Every member of the "A.R.R.L. Emergency Corps" will be expected to make known his availability for emergency communication to local Red Cross officials, railroads, military units, police departments, representatives of press associations and the like. All Corps stations should be on record with such organizations and other competent authorities so that they will be called upon to assist when emergency communication is necessary. The front of the membership card in the Emergency Corps is shown elsewhere in these columns; on the reverse is a summary of communication principles to be followed in emergencies and an introduction to local agencies that you may have occasion to assist.

The goal of the "A.R.R.L. Emergency Corps" is: AN AMATEUR RADIO EMERGENCY STATION IN EVERY COMMUNITY!! Will you help us achieve that aim? Amateur Radio as an emergency communication system is invaluable. Every red-blooded ham should want to do his part! Send your application to the Emergency Corps as soon as possible. We need you! And your community needs you! Clubs working in the interest of amateur radio and their communities have a real opportunity in this field too, and we shall be glad to enroll club stations in the A.E.C.!

Drop a postal to the League today for the A.E.C. application blank which carries further information. Then get your membership card as soon as you can qualify! An Emergency Communication Manual, now in the course of preparation, will contain rules and suggestions

on emergency work. This will be sent free to all A.E.C. members as soon as available.

### The R-S-T System of Signal Reports

● For many years amateurs have been concerned with the problem of exchanging concise yet complete reports. From the simple use of QSA-QRK-QRZ in the early days to indicate three possible degrees of loudness, the requirements have become more exacting, involving the use of numbers to indicate not only gradations of signal strength, but to show other qualities of signals such as readability and tone. Just as the QSA-definitions tended to confuse strength and readability, the earlier tone scales included mention of key clicks, back wave, modulation frequency, etc., making the scales incapable of ready memorization, and improperly adding things besides tone which were associated with the complex signals we hear. The demand for greater accuracy, for fuller reports, and maximum brevity in transmission, led amateurs to adopt the R-S-T system which eliminated some of these earlier defects.

W2BSR devised the R-S-T system now used almost exclusively in domestic work and growing in popularity in international amateur

#### READABILITY

- 1 — Unreadable
- 2 — Barely readable, occasional words distinguishable
- 3 — Readable with considerable difficulty
- 4 — Readable with practically no difficulty
- 5 — Perfectly readable

#### SIGNAL STRENGTH

- 1 — Faint — signals barely perceptible
- 2 — Very weak signals
- 3 — Weak signals
- 4 — Fair signals
- 5 — Fairly good signals
- 6 — Good signals
- 7 — Moderately strong signals
- 8 — Strong signals
- 9 — Extremely strong signals

#### TONE

- 1 — Extremely rough hissing note
- 2 — Very rough a.c. note, no trace of musicality
- 3 — Rough, low-pitched a.c. note, slightly musical
- 4 — Rather rough a.c. note, moderately musical
- 5 — Musically modulated note
- 6 — Modulated note, slight trace of whistle
- 7 — Near d.c. note, smooth ripple
- 8 — Good d.c. note, just a trace of ripple
- 9 — Purest d.c. note

(If the note appears to be crystal controlled simply add an X after the appropriate number.)

# The Radio Amateur's Handbook . . . . .

work. The completeness and time-saving characteristics are appreciated wherever the R-S-T system is used. The table of R-S-T definitions is given in this section.

The R-S-T system is an abbreviated method of indicating the main characteristics of a received signal, the Readability, Signal Strength, and Tone. The method of using the R-S-T system is extremely simple. The letters R-S-T determine the order of sending the report. In asking for this form of report, one transmits RST? or simply QRK?

Such a signal report as "RST 387X" (abbreviated to 387X now it is understood that reports follow the R-S-T system) will be interpreted as, "Your signals are readable with considerable difficulty; good signals (strength); near d.c. note, smooth ripple; crystal characteristic noticed." Unless it is desired to comment in regard to a crystal characteristic of the signal, *a single three-numeral group will constitute a complete report on an amateur signal.* Various report combinations are based on the table.

## The QSA- and R-Systems

● The Madrid Convention (Appendix 10, General Regulations) gives a scale of definitions which indication, given after the appropriate Q signal, shows progressive signal strength. QSA means, "The strength of your signals is . . ." Some of the definitions, however, appear to confuse audibility or signal strength with readability, which may be impaired even when signals are strong, by atmospherics, interference, a noisy receiver, etc.

- QSA1 — Hardly perceptible, unreadable
- QSA2 — Weak, readable now and then
- QSA3 — Fairly good, readable but with difficulty
- QSA4 — Good, readable
- QSA5 — Very good, perfectly readable

Since, due to the wording, the internationally-formulated definitions of signal strength by the QSA system have been used by amateurs as a "readability" scale, amateurs have supplemented this by use of the following table of definitions, constituting the R system of indicating audibility, or signal strength without regard to other sounds in the 'phones or room.

- R1 — Faint signals, just audible
- R2 — Weak signals, barely audible
- R3 — Weak signals, copiable (in absence of any difficulty)
- R4 — Fair signals, readable
- R5 — Moderately strong signals
- R6 — Strong signals
- R7 — Good strong signals (such as copiable through interference)
- R8 — Very strong signals; can be heard several feet from phones
- R9 — Extremely strong signals

The QSA and R systems are usually used

together, when used. The R-S-T system reports are always a three-numeral block, so the definitions cannot be confused with QSA-R designations.

## Interference Problems

● The subject of public relations is important to us amateurs both individually and as an organization. No amateur can long afford to operate when he knowingly interferes widely with broadcast reception in his neighborhood and when there are simple remedies to be applied. Even the observance of prescribed quiet hours, while covering the situation legally, does not entirely suffice. Patience in explaining, frankness, tolerance in listening to other viewpoints and other qualities of diplomacy are needed to give the full technical explanations required. Evidence of fair dealing, and coöperation with listeners is always given weight when F.C.C. representatives find it necessary to investigate facts in an interference case.

Actually most interference is traceable to faulty electrical equipment, inadequate shielding or poor design of receivers, and less than one per cent. of the interference reported is traceable to amateur sources.

It is necessary for both parties to an interference problem to understand that *both the transmitter and the receiver* are part of the problem — improved adjustment of the former — improved design of the latter to increase its selectivity, may be necessary. Where "proximity" is part of the problem special measures should be considered to isolate circuits and equipment by installation of suitable "traps," to aid selectivity, or by chokes and condensers to prevent "coupling" through common supply line wires. Each individual must accept responsibility for his equipment. Coöperation is the only policy that will help either party — a full measure of coöperation and understanding must be brought about in every interference case.

## Club Interference Work

● We recommend and request that each A.R.R.L. affiliated club organization maintain an interference committee, to keep order, make investigations and recommendations locally, coöperate with the press, the public, and listeners who wish to file complaints of amateur interference. These committees can be composed of representative broadcast listeners, amateurs and with one member from a local newspaper to assist in collecting and referring complaints. A few leading questions will disclose the amateur cases and other difficulties can be referred to local power and communications companies.

### Operating Hints

● Listen carefully for several minutes before you use the transmitter to get an idea of what stations are working. This will help in placing messages where they belong.

Report your messages to the local Section official every month on time, otherwise you cannot expect your report to reach *QST*. Reports sent to Headquarters are routed back to the local officials who make up the monthly report.

Don't say, "QRM" or "QRN" when you mean "QRS."

Don't acknowledge any message until you have received it completely.

Don't CQ unless there is definite reason for so doing. When sending CQ, use judgment. Sign your call frequently, interspersed with calls, and at the end of all transmissions.

Abbreviated standard procedure deserves a word in the interest of brevity on the air. Abbreviated practices help to cut down unnecessary transmission. However, make it a rule not to abbreviate unnecessarily when working an operator of unknown experience.

*NIL* is shorter than *QRU CU NEXT SKED*. Instead of using the completely spelled out preamble *HR MSG NR 287 WIGME CK 18 MIDDLEBURY CONN OCTOBER 28 TO*, etc., transmission can be saved by using *287 WIGME 18 MIDDLEBURY CT OCT 28 TO*, etc. One more thing that conserves operating time is the cultivation of the operating practice of writing down "237 W1UE 615P 11/13/37" with the free hand during the sending of the next message.

"Handling" a message always includes the transmission and receipt of radio acknowledgment (QSL) of same, and entry of date, time and station call on the *traffic*, as handled, for purposes of record.

### A-1 Operator Club

● The object of this club is to promote and encourage a high calibre of operating in the amateur bands. To become a member, one must be nominated by at least two operators who already "belong." In choosing operators for the "A-1 Operator Club" the following points are considered by members: (1) General keying. Well formed characters and good spacing will be considered before "speed." Similarly, good voice operating technique, clearness, brevity, cooperation with other operators, careful choice of words, etc., may be used as criteria in nominating 'phone operators. (Special extra credit may be given for use of standard word-lists in identifying calls and unusual

expressions.) (2) Procedure. Use of correct procedure is a natural qualification. This applies to both general operating and message handling. (Procedure as recommended in this *Handbook* is a good standard.) Long CQs, unnecessary testing, long calls without signing, too much repetition when not requested, and all other such poor practice, are grounds for disqualification. (3) Copying ability. This to be judged by proficiency in copying through QRM, QRN and other difficulties, and accuracy of copy, as well as by ability to copy at fast speeds. (4) Judgment and courtesy. The "CUL 73" type operator can never make the grade. An operator should be courteous and willing to consider the other fellow's viewpoint. He should QRS or QSZ, without "crabbing" when requested. He should embrace every opportunity to assist beginners, and to help them along through some of the more trying experiences of operating. He should never knowingly QRM another station, but should cooperate as much as possible with stations working on his frequency. He should not decry "lid" operating but should assist the newer operators and offer friendly, courteous advice as to how they might improve their operation. The matter of "good notes," "sharp" signals, lack of frequency "wabbulation," good quality ('phone), use of sound technical arrangement and proper adjustment, while not directly points of *operating* ability, are certainly concerned directly *with courtesy and judgment* and as such these things must be weighed under (4).

A-1 operators, in considering candidates for nomination to the "club" carefully consider each of the four qualifications, each counting a possible 25 points (of 100 total). No operator nominated should have a rating of less than 15 on any qualification, and the total must be *80 or over*, to warrant a recommendation for a particular operator.

Regarding *disqualification*. After an operator has been nominated if exception shall be taken, or complaint made of faults in his operating work, copy of such complaint shall be sent to him in order that he may profit from constructive suggestions, or explain the circumstances. In the event of a sufficient number of objections to a nomination or lacking a satisfactory explanation, the call may be added to a "disqualified" list or record at Headquarters.

The A-1 Operator club should include in its ranks *every* good amateur operator who follows standard practice after he gets on the air, and after gaining experience contacts hams who are already members. *Aim to become a fine operator, and also an "A-1" operator.*

## Message Handling

**A**MATEUR traffic handling is effective and highly developed, *if one knows how to use it*. Don't expect that you can get on the air with the message you have written and give it to the first station that comes along and expect miracles to happen. You fellows who get your fun principally from DX, rag chewing, and building equipment should appreciate that you must place the occasional message *you* start and wish to have reach its destination, not in the hands of others like yourselves, but in the hands of one of the many operators who specialize in keeping schedules and handling messages, one who gets his fun mainly out of this branch of our hobby, who knows the best current routes and is in a position to use them. Reference to the "station activities" of the latest *QST* to identify the calls gleaned from listening as those of men actually handling and reporting traffic regularly will enable anyone to start a message on its way intelligently by giving it to a station that will properly and reliably direct it on its way with minimum delay.

Station owners may originate traffic of *any kind* going to any part of the United States, Hawaii, Porto Rico, Alaska, or the Philippines. Messages with amateurs in Canada, Chile, and Peru may be handled under certain restrictions. Important traffic in emergencies or messages from expeditions for delivery in Canada must be put on a land wire by the U. S. amateur station handling. International regulations prohibit the handling of third party messages to the majority of foreign countries. Messages relating to experiments and personal remarks of such unimportance that recourse to the public telegraph service would be out of the question may be handled freely with the amateurs of any country, but third party messages only under special arrangements between U. S. A. and other governments, and only to the extent agreed upon by the contracting governments.

Messages may be accepted from friends or acquaintances for sending by amateur radio. Such messages should be put in as complete form as possible before transmitting them. *Incomplete messages should not be accepted*. As mes-

sages are often relayed through several stations before arriving at their destination, *no abbreviations should be used in the text* as mistakes are bound to happen when the text is shortened in this manner. To people not acquainted with radio abbreviations, messages written in shortened form are meaningless. Delivering stations must be careful to see that messages are written out fully.

In handling messages we are doing something really worth while. We want to start only good worth-while messages from our stations. Our efforts should be directed to making the quality of our message service high. The number of messages we handle is of secondary importance. The *kind of messages* we originate or start from our stations and the *speed* with which the messages pass through our station and the *reliability or accuracy* with which the messages are handled are the things of paramount importance.

Message handling as a form of amateur activity has never required any boosting — for just as the ultimate aim of amateur radio on all frequency bands is *communication*, so is the relaying of word by radiogram a "natural" when one has something to say to a party beyond immediate reach. Not all hams perhaps appreciate the utility that results from using amateur message service in our ham correspondence. However, no ham, not even a new member of the brotherhood, but feels the satisfaction of having really accomplished something tangible in exchanging a message (recorded communication) with another amateur. Of course not all beginners develop the advanced operating technique of the finished message handler, but it is within the reach of all who will try. The knack of handling a key is explained elsewhere. In this chapter we shall discuss basic points to follow in message handling activities.

### Message Form

● Each message originated and handled should contain the following component parts in the order given:

- (a) Number
- (b) Station of Origin

## Message Handling

- (c) Check
- (d) Place of Origin
- (e) Time filed
- (f) Date
- (g) Address
- (h) Text
- (i) Signature

A standard form is useful because it enables one to know just what is coming next, and makes accuracy possible with speed. The check, placed where it is, immediately informs the receiving operator of the length of the message before too much time has been taken. He can "get set" for a long one when necessary. This form also facilitates the transfer of messages to commercial circuits in emergencies or whenever necessary. If the city of origin is different from the station of origin it is shown directly in use of the new A.R.R.L. form. Start some messages to familiarize yourself with the proper way to write and send traffic in good form. Just as you would be ashamed to admit it if you could not qualify as an experienced amateur by at least "15 w.p.m." code capability, be equally proud of your basic knowledge of how to properly form and send record communications.

(a) Every message transmitted should bear a "number." Beginning on the first day of each calendar year, each transmitting station establishes a new series of numbers, beginning at Nr. 1. Keep a sheet with a consecutive list of numbers handy; file all messages without numbers; and when you send the messages, assign numbers to them from the "number sheet," scratching off the numbers on that list as you do so, making a notation on the number sheet of the station to which the message was sent and the date. Such a system is convenient for reference to the number of messages originated each month.

(b) The "station of origin" refers to the call of the station at which the message was filed and this should always be included so that a "service" message may be sent back to the originating station if something interferes with the prompt handling or delivery of a message. In the example of preamble given W1MK is the station of origin, that call being the one assigned the League Headquarters Station.

(c) Every word and numeral in the text of a message counts in the check. Full information on checking messages is given later in this chapter.

(d) The "place of origin" refers to the name of the city from which the message was started. If a message is filed at League Headquarters by someone in West Hartford, Conn., the preamble reads *Nr 457 W1MK ck 21 West Hartford Conn 8R57 p June 11, etc.*

If a message is sent to your radio station by mail the preamble shows the place of origin as the town where the message came from. If a message was filed at A.R.R.L. Headquarters and if it came by mail from Wiscasset, Maine, the preamble would run like this to avoid confusion: *Hr msg nr 457 W1MK ck 21 Wiscasset Maine 8R57 p June 11, etc.*

(e) The time filed is the time at which the message for transmission is received at the office of transmission to be sent.

(f) Every message shall bear a "date" and this date is transmitted by each station handling the message. The date is the "day filed" at the originating station unless otherwise specified by the sender.

(g) The "address" refers to the name, street and number, city, state, and telephone number of the party to whom the message is being sent. A *very complete address* should always be given to *insure* delivery. When accepting messages this point should be stressed. In transmitting the message the address is followed by a double dash or break sign (— . . . —) and it always precedes the text.

(h) The "text" consists of the words in the body of the message. No abbreviations should ever be substituted for the words in the text of the message. The text follows the address and is set off from the signature by another break (— . . . —).

(i) The "signature" is usually the name of the person sending the message. When no signature is given it is customary to include the words "no sig" at the end of the message to avoid confusion and misunderstanding. When there is a signature, it follows the break; the abbreviation "sig" is not transmitted.

The presence of unnecessary capital letters, periods, commas or other marks of punctuation may alter the meaning of a text. For this reason commercial communication companies use a shiftless typewriter (capitals only). The texts of messages are typed in block letters (all capitals) devoid of punctuation, underlining and paragraphing, *except where expressed in words*. In all communication work, accuracy is of first importance. Spell out figures and punctuation.

### Numbering Messages

● Use of a "number sheet" or consecutive list of numbers enables any operator to tell quickly just what number is "next." Numbers may be crossed off as the messages are filed for origination. Another method of use consists of filing messages in complete form *except for the number*. Then the list of numbers is consulted and numbers assigned as each

# The Radio Amateur's Handbook . . . . .

message is sent. As the operator you work acknowledges (QSLs) each message cross off the number used and note the call of the station and the date opposite this number.

A "number sheet" is quite essential to help in keeping records straight, and to avoid possible duplication of numbers on messages. It is of assistance in checking the count of originated messages in a given month. With each amateur station log book A.R.R.L. provides C.D. Form 3, a *number sheet of originated messages* — or you can start a consecutive list of numbers in January of each year on a blank sheet, adding numbers as needed.

The original number supplied each message by the operator at the originating station is transmitted by each station handling the message. No new numbers are given the message by intermediate stations. If a message is filed at W1MK on April 9 and when sent is given the number "nr 458," this same call, date and number are used by all stations handling this message. Only at stations where a message originates or is filed can a number be assigned to a message. Intermediate relaying stations neither change numbers nor supply new ones to messages.

## Checking Traffic — The Land Line Check

● The League's check is the land line or "text-only" count, consisting of the count of only the words in the body or text of the message. It is quicker and easier to count in this fashion than to use the cable count of words in address, text and signature check which is followed in marine operating work, this simplification being the reason for its adoption. When in the case of a few exceptions to the basic rule in land line checking certain words in address, signature or preamble are counted, they are known as extra words, and all such are so designated in the check right after the total number of words.

### COUNTING WORDS IN MESSAGES

The check includes: (1) all words, figures and letters in the body, and (2) the following extra words:

(a) Signatures except the first, when there are more than one (a title with signature does not count extra; but an *address* following a signature does).

(b) Words "report delivery," or "rush" in the check.

(c) Alternative names and/or street addresses, and such extras as "personal" or "attention-----"

Examples: "Mother, Father, James and Henry" is a family signature, no names

counted extra. "John Brown, Second Lieutenant" or "Richard Johnson, Secretary Albany Auto Club" are each one signature with no words counted as extra. An official title or connection is part of one signature, not extra. "Technical Department, Lamb, *Grammer and Mix*" as a signature would count three extra words, those italicized after the first name counting as extras. The check of a message with ten words text and three such extras in the signature would be "CK 13 3 extra."

Dictionary words in most languages count as one word irrespective of length of the word. Figures, decimal points, fraction bars, etc. count as one word *each*. It is recommended that where feasible words be substituted for figures to reduce the possibility of error in transmission. Detailed examples of word counting are about as difficult in one system of count as another.

Count as words dictionary words taken from English, German, French, Spanish, Latin, Italian, Dutch and Portuguese languages; initial letters, surnames of persons, names of countries, cities and territorial subdivisions. Abbreviations as a rule should be used only in service messages. Complete spelling of words is one way to avoid error. Contractions such as "don't" should be changed to "do not." Examples:

Emergency (English dictionary).....	1 word
Nous arriverrons dimanche (French dictionary)	3 words
DeWitt (surname).....	1 word
E.L.B.D. (initials).....	4 words
United States (country).....	1 word
President Hoover (steamship).....	1 word
Prince William Sound.....	3 words
M.S. City of Belgrade (motor ship).....	2 words

### EXCEPTIONS

A.M., P.M.....	1 word
F.O.B. (or fob).....	1 word
O.K.....	1 word
Per cent (or percent).....	1 word

Figures, punctuation marks, bars of division, decimal points, count each separately as one word. The best practise is to spell out all such when it is desired to send them in messages. In groups consisting of letters and figures *each* letter and figure will count as one word. In ordinal numbers, affixes d, nd, rd, st, and th count as one word. Abbreviations of weights and measures in common use count as one word each. Examples:

10 000 000 (figures).....	8 words
Ten millions (dictionary words).....	2 words
5348 (figures).....	4 words
67.98 (figures).....	5 words
64A2.....	4 words
45 ¼ (figures and bar of division).....	5 words
3rd (ordinal number and affix).....	2 words

Groups of letters which are not dictionary words of one of the languages enumerated, or



## • • • • • *Message Handling* • • •

combinations of such words will count at the rate of five letters or fraction thereof to a word. In the case of combinations each dictionary word so combined will count as a word. In addition USS USCG etc. written and sent as compact letter-groups count as one word. Examples:

Tyffa (artificial 5 letter group) . . . . .	1 word
Adecol (artificial 6 letter group) . . . . .	2 words
allright, alright (improperly combined) . . . . .	2 words
Dothe (improperly combined) . . . . .	2 words
ARRL . . . . .	1 word

At the request of sender the words "report back delivery" asking for a service showing success or failure in delivering at the terminal station, may be inserted after the check or "rush" or "get answer" similarly, such words counting as extras in the group or check designation as just covered by example. "Phone" or "Don't Phone" or other sender's instructions in the address are not counted as extra words. In transmitting street addresses where the words east, west, north or south are part of the address, spell out the words in full. Suffixes "th," "nd," "st," etc., should not be transmitted. Example: Transmit "19 W 9th St" as "19 West 9 St." "F St NE" should be sent, "F St Northeast." When figures and a decimal point are to be transmitted, add the words CNT DOT in the check.

Isolated characters each count as one word. Words joined by a hyphen or apostrophe count as separate words. Such words are sent as two words, without the hyphen. A hyphen or apostrophe each counts as one word. However, they are seldom transmitted. Two quotation marks or parenthesis signs count as one word. Punctuation is *never* sent in radio messages except at the express command of the sender. *Even then it is spelled out.*

Here is an example of a plain language message in correct A.R.R.L. form carrying the land line check:

```
NR 601 WIINF CK 9 WEST HARTFORD CONN
1R15P OCT 28
ALL RADIO HAMS
9 COMPLETE ADR ST
ANYCITY USA
ALL AMATEURS ARE REQUESTED TO FOLLOW
STANDARD ARRL FORM
```

HANDY ARRL CM

Very important messages should be checked carefully to insure accuracy. Request originators to *spell out all punctuation marks that must appear in delivered copies. Likewise, never abbreviate in texts, or use ham abbreviations except in conversations.*

● Message handling is one of the major things that lies in our power as amateurs to do to

show our amateur radio in a respected light, rather than from a novelty standpoint. Regardless of experimental, QSL-collecting, friendly ragchews, and DX objectives, we doubt if the amateur exists who does not want to know how to phrase a message, how to put the preamble in order, how to communicate wisely and well when called upon to do so. Scarcely a month passes but what some of us in some section of our A.R.R.L. are called upon to add to the communication service record of the amateur.

It is important that deliveries be made in business-like fashion to give the best impression, and so that in each case a new friend and booster for amateur radio may be won. Messages should be typed or neatly copied, preferably on a standard blank, retaining original for the F.C.C. station file where these are mailed. The designation and address of the delivering station should be plainly given so a reply can be made by the same route if desired.

For those who would disparage some message texts as unimportant, perhaps a reminder is in order that in the last analysis it is not the importance to the ham that handles it that counts, but the importance to the party that sends and the party that receives a message. Furthermore, what sort of a communication service is it that concerns itself with what is said in a message, so long as the remarks are not obscene so the transmission is contrary to law? The individual handling of traffic in quantities small as well as large is to a very great extent the material that we amateurs use for developing our operating ability, for organizing our relay lines, for making ourselves such a very valuable asset to the public and our country in every communications emergency that comes along, not to mention the individual utility and service performed by each message passed in normal amateur communications.

For those "breaking-in" may we say that any O.R.S., Trunkliner or experienced A.R.R.L. traffic handler will be only too glad to answer your questions and give additional pointers both in procedure and concerning your station set-up to help you make yours a really effective communications set-up. Since experience is the only real teacher we conclude by suggesting to all and sundry that becoming proficient in any branch of the game is partly just a matter of practice. Start a few messages, to get accustomed to the form. Check some messages to become familiar with the official A.R.R.L. (land line) check. You will find increased enjoyment in this side of amateur radio by adding to your ability to perform; by your

# The Radio Amateur's Handbook . . . . .

familiarity with these things the chance of being able to serve your community or country in emergency will be greater. Credit will be reflected on amateur radio as a whole thereby.

## Foreign Traffic Restrictions

● Any and all kinds of traffic may be handled between amateur stations in different parts of the United States, Hawaii, Alaska, and Porto Rico. There is no qualification or restriction except that amateur status must be observed and no material considerations become involved in the communications. Radio amateurs in all U. S. possessions except the Philippines (which has its own radio administration) are licensed by the U. S. Federal Communications Commission. The F.C.C. permits U. S. amateurs to handle with P. I. all types of communication permitted internally in the U. S. as with the other possessions. But the Philippine Island administration, since part of the inter-island communications system is government owned, leans toward the incorporation of certain additional restrictions on its amateurs relating to the handling of messages of "business importance."

The radio portion of the Madrid treaty is in full effect as between the United States and the following foreign countries: Australia and territories, Austria, Belgium and Belgian Congo and Ruandi Urundi, Bulgaria, China, Colombia, Czechoslovakia, Denmark, Egypt, Estonia, Ethiopia, Finland, Germany, British India, Italy and its colonies and islands, Japan (and Chosen, Taiwan, Karafuto, Kwantung, and islands under mandate), Morocco except Spanish zone, the Netherlands plus Netherlands Indies, Surinam and Curacao, New Zealand, Persia, Poland, Spain and its territory of Gulf of Guinea, Switzerland, Syria & Lebanon, Vatican City State, Yugoslavia.

The treaty relation also exists with Canada, but the handling of certain types of traffic is permitted by special arrangement with Canada, Chile, and Peru. With all other countries we are free to handle third-party traffic — if we can find a ham on the other end who is not prohibited by his government from handling messages.

*Internationally* the general regulations attached to the international communications treaty state the limitations to which work between amateur stations in different foreign countries is subject. In practically every country outside our own country and its possessions, the government owns or controls the public communications systems. Since these systems are maintained as a state monopoly, foreign amateurs have been prohibited by their

governments from exchanging traffic which might be regarded as "competition" with state owned telegraphs. The international treaty regulations reflect this condition and the domestic traffic restrictions (internal policy) of the majority of foreign countries. August 1934 *QST* (pages 52-53), Oct. 1935 *QST* (p. 57-58) and Sept. 1936 *QST* (p. 41-42) give interesting résumés of the amateur regulations of foreign countries. Any country ratifying the Madrid (1932) Convention can make its domestic arrangement as liberal as it likes; in addition it may conclude special agreements with other governments for amateur communications that are *more liberal* than the quoted terms of the treaty itself. If no specific formal negotiations have been concluded, however, amateurs must observe the following (treaty) regulation in conducting international amateur work. Article 8:

The exchange of communications between amateur stations and between private experimental stations of different countries shall be forbidden if the Administration of one of the interested countries has given notice of its opposition to this exchange.

When this exchange is permitted the communications must be conducted in plain language and be limited to remarks of a personal nature, for which, by reason of their lack of importance, recourse to the public telegraph service would not be warranted. It shall be absolutely forbidden to licensees of amateur stations to transmit international communications emanating from third parties. The above provisions may be modified by special arrangements between the interested countries.

Referring to the first paragraph above, in the years since the Washington Convention (1927) *no* prohibition on amateur communication (international QSOs) has been filed by *any* country with the Berne Bureau. In some countries, principally European, amateurs are restricted by regulation to privileges much *less* than made available by international agreement. The use of some amateur bands is withheld, or the width of certain bands severely restricted by proclamation of "buffer bands," power is restricted, absurd time regulations restricting operation to two hours per day, fifteen minutes per hour, etc., enacted, and "third party" messages absolutely forbidden *domestically* as well as internationally. In the U. S. A. it is the policy, and of course necessary to take care of our greater numbers of amateurs, to give amateurs the fullest frequency allocations and rights possible under international treaty provisions, and to permit free exchange of domestic non-commercial traffic in addition. This policy has justified itself, giving the public amateur radio traffic service, and developing highly skilled operators and technicians who have the ability to keep the U. S. A. in the lead in radio matters.



**TEE OF DELIVERY.** The individual in charge of the station has full powers to refuse any traffic unsuitable for radio transmission, or addressed to points where deliveries cannot be made. Relaying is subject to radio conditions and favorable opportunity for contacting. Also, it is desirable to word messages as telegrams would be worded instead of writing letters. Better service can be expected on 15-word texts of apparent importance than on extremely long messages. Traffic should *not* be accepted for "all over the world" since there are not active amateurs in all countries, and more important, since the majority of countries outside the U. S. A. and Canada prohibit the handling of third party traffic altogether, by a restriction written into the station licenses of foreign amateur stations.

Careful planning and organized schedules are necessary if a *real* job of handling traffic is to be done. Advance schedules are essential to assist in the distribution of messages. It may be possible to schedule stations in cities to which you know quantities of messages will be filed. Distribute messages, in the proper directions, widely enough so that a few outside stations do not become seriously overburdened. Have the latest copies of *QST* at hand and study the traffic summaries at the end of sectional activity reports. Nearly all these stations are reliable Official Relay Stations interested in traffic handling. The list of calls will help you to identify or distinguish reliable, consistent operators to whom to entrust valuable messages.

Operators must route traffic properly — not merely aim to "clear the hook." New stations worked should be informed of the amount of traffic you wish to clear and agree to handle the messages, *before* they are sent. Delays and non-deliveries result from giving an operator more than he can handle efficiently. Operators should *not* accept traffic when not in a position to continue operating their stations to give it proper handling.

It is better to handle a small or moderate volume of traffic *well* than to attempt to break records in a manner that results in delayed messages, non-deliveries, and the like which certainly cannot help in creating any public good-will for amateur radio.

### Tracing Messages

● *Tracing messages* is sometimes necessary to find where traffic was held or delayed. Tracing is usually accomplished by sending a copy of the message and a letter requesting that the time, date, and station calls of the stations from whom the message was received and to

whom the message was given, be noted. Tracers are forwarded in rotation to all stations handling a message.

### Amateur Stations at Exhibits and Fairs

● Where installation of an amateur radio station in a booth is planned, a *portable* amateur station can be installed. The station must operate under F.C.C. license of course. Since every amateur station owner can use his regular authorization for portable work under certain regulations, a local amateur already licensed can accept responsibility for the station. Of course the proper F.C.C. office must be notified of the location from which the equipment will be operated, and the dates of such operation, in advance, as provided in the regulations. No license for station equipment is required if the exhibit will not include a transmitter in actual operation. Whatever type of exhibit is planned, write A.R.R.L. in advance, in order to receive sample material to make your amateur booth more complete.

If the time is short and there is no opportunity for special organization of schedules to insure reliable routing and delivery, quite likely exhibit work, to be most productive of good-will results, had best *not* include message handling plans — at least not from the booth-station itself where subject to noise, electrical interference, and other handicaps. To handle such traffic as offered with *real efficiency*, it should be distributed for origination via existing schedules of the *several most reliable local amateur stations*. *By dividing the traffic filed with other stations it may be sent more speedily on its way.* The full coöperation of all local stations should be requested. However, be sure that the operators undertaking to help are qualified and have good schedules for distributing messages.

"Show stations" must avoid origination of "poor traffic" by rigid supervision and elimination of meaningless messages with guessed-at, innacurate and incomplete addresses right at the source. Misaddressed and rubber-stamp-type traffic will always be subject to serious delays and non-delivery, and especially so when the traffic load is so great that handling such messages becomes irksome and work instead of fun. What good is any message if it cannot be delivered?

### The "Apparent Importance"

● The "apparent importance" of a dispatch has been proved to have a very direct bearing on the speed of relaying a message and the likelihood of its delivery, especially if the re-



# The Radio Amateur's Handbook . . . . .

W1INF, repeating the combination three times.

He listens and hears W9CXX in Cedar Rapids calling him, W1INF W1INF W1INF DE W9CXX W9CXX W9CXX AR.

Then he answers W9CXX indicating that he wishes him to take the message. W1INF says W9CXX W9CXX DE W1INF R QSP MILL VALLEY CALIF NEAR SF? K.

After W9CXX has given him the signal to go ahead, the message is transmitted, inserting the "number" in its proper place, and assigning the next number indicated on the "number sheet." The message is sent in A.R.R.L. sequence.

HR MSG NR 78 W1INF CK18 WEST HARTFORD  
CONN NPT NOV 18  
ALAN D WHITTAKER JR W6SG  
79 ELINOR AVE  
MILL VALLEY CALIF  
SUGGEST YOU USE ARRL TRUNK LINE K  
THROUGH W5NW TO HANDLE PROPOSED VOL-  
UME TRAFFIC REGARDS

BUBB W1JTD

W9CXX acknowledges the message like this: W1INF DE W9CXX NR 78 R K. Not a single R should be sent unless the whole message has been correctly received.

The operator at W1INF writes in the number of the message, scratches off number 78 on the "number sheet," putting W9CXX after the number. In the "sent" space at the bottom of the message blank he notes the call of the Cedar Rapids station, the date, time, and his own personal "sine." At the same time he concludes with W9CXX something like this: R QRU 73 GB VA W1INF, meaning, "All received OK, I have nothing more for you, see you again, no more now, best regards, good-bye, I am through with you and shall at once listen for other stations who may wish to call me. W1INF is now signing off."

W9CXX will come back with I R GB AR VA W9CXX, meaning "I understand, received you OK, good-bye, I am through." Then he will listen a few minutes to see if anyone is calling him. He will listen particularly for California stations and try to put the message through W6SG or a neighboring station. If he does not hear someone calling him, he can "CQ Calif."

## Getting Fills

● Sometimes parts of a message are not received correctly or perhaps due to fading or interference there are gaps in the copy. The problem is to ask for "fills" or repeats in such a way as to complete the message quickly and with the minimum of transmission.

If the first part of a message is received but substantially all of the latter portions lost, the

request for the missing parts is simply RPT TXT AND SIG, meaning "Repeat text and signature." PBL and ADR may be used similarly for the preamble and address of a message. RPT AL or RPT MSG should not be sent unless nearly all of the message is lost.

Each abbreviation used after a question mark ( . . — — . . ) asks for a repetition of that particular part of a message.

When a few word-groups in conversation or message handling have been missed, a selection of one or more of the following abbreviations will enable you to ask for a repeat on the parts in doubt. Phone stations of course request fills by using the full wording specified, without attempt at abbreviation.

Abbreviation	Meaning
?AA.....	Repeat all after.....
?AB.....	Repeat all before.....
?AL.....	Repeat all that has been sent.
?BN...AND.....	Repeat all between... and...
?WA.....	Repeat the word after.....
?WB.....	Repeat the word before.....

The good operator will ask for only what fills are needed, separating different requests for repetition by using the break sign or double dash ( — . . . — ) between these parts. There is seldom any excuse for repeating a whole message just to get a few lost words.

Another interrogation method is sometimes used, the question signal ( . . — — . . ) being sent between the last word received correctly and the first word (or first few words) received after the interruption. RPT FROM . . . . . TO . . . . . is a long, clumsy way of asking for fills which we have heard used by beginners. These have the one redeeming virtue of being understandable.

The figure four ( . . . — ) is a time-saving abbreviation which deserves popularity with traffic men. It is another of those hybrid abbreviations whose original meaning, "Please start me, where?" has come to us from Morse practice. Of course ?AL or RPT AL will serve the same purpose, where a request for a repetition of parts of a message have been missed. While these latter usages are approved, the earlier practice is still followed by some operators.

## Delivering Messages

● The only service that we can render anyone by handling a message comes through "delivery." Every action of ours in sending and relaying messages leads up to this most important duty. Unless a message is delivered, it might as well never have been sent.

There is no reason for anyone to accept a

## • • • • • *Message Handling* • • •

message if he has no intention of relaying it or delivering it promptly. It is not at all discourteous to refuse politely to handle a message when it will be impossible for you to forward it to its destination.

Occasionally message delivery can be made through a third party not able to acknowledge the radiogram he overhears. When a third party happens to be in direct contact with the person addressed in the message he is able to hand him an unofficial confirmation copy and thus to make a delivery much sooner than a delivery could be made otherwise. It is *not* good radio etiquette to deliver such messages without explaining the circumstances under which they were copied, as a direct delivery discredits the operator who acknowledged the message but who through no fault of his own was not able to deliver so promptly. With a suitable note of explanation, such deliveries can often improve A.R.R.L. service and win public commendation.

*Provisions of the Radio Act of 1934 make it a misdemeanor to give out information of any sort to any person except the addressee of a message.* It is in no manner unethical to deliver an unofficial copy of a radiogram, if you do it to improve the speed of handling a message or to insure certain and prompt delivery. Do not forget that there are heavy fines prescribed by Federal laws for divulging the contents of messages to anyone *except* the person addressed in a message.

When it is possible to deliver messages in person, that is usually the most effective way. When the telephone does not prove instrumental in locating the party addressed in the message it is usually quickest to mail the message.

To help in securing deliveries, here are some good rules to follow:

*Messages received by stations shall be delivered immediately.*

*Every domestic message shall be relayed within forty-eight (48) hours after receipt or if it cannot be relayed within this time shall be mailed to the addressee.*

*Messages for points outside North America must not be held longer than half the length of time required for them to reach their destination by mail.*

We are primarily a radio organization, and the bulk of our messages should go by radio, not by mail. The point is that messages should not be allowed to fall by the way, and that they should be sent on or delivered just as quickly as possible. When a message cannot be delivered, or if it is unduly delayed, a "service" message should be written and started back to the "office of origin."

Each operator who reads these pages is asked to assume *personal responsibility* for the accuracy and speed of each message handled so that we can each have reason to take personal pride in our operating work and so that we will have just cause for pride in our League as a whole. Do *your* part that we may approach a 100% delivery figure.

### The Service Message

● A service message is a message sent by one station to another station relating to the service which we are or are not able to give in message handling. The service message may refer to non-deliveries, to delayed transmission, errors, or to any phase of message handling activity. It is not proper to abbreviate words in the texts of regular messages, but it is quite desirable and correct to use abbreviations in these station-to-station messages relating to traffic-handling work.

In line with the practice outlined above W3CA makes up a service message asking W7GE (station of origin of a message with insufficient address) to "give better address":

```
HR SVC NR 291 W3CA CK XX ROANOKE VA NFT
AUG 19
L C MAYBEE W7GE
110 SOUTH SEVENTH AVE
PASCO WASHN — . . . —
UR NR 87 AUG 17 TO CUSHING SIG BOB HELD
HR UNDL D PSE GBA — . . . —           WOHLFORD W3CA
```

### Counting Messages

● So that we can readily keep track of our messages and compare the number originated and delivered each month to learn some facts about the "efficiency" of our work in handling messages, a method of counting is used. Each time a message is *handled by radio* it counts one in the total.

A message received in person, by telephone, by telegraph, or by mail, *filed at the station and transmitted by radio* in proper form, counts as *one originated*.

A message *received by radio and delivered* in person, by telephone, telegraph, or mail, counts as *one delivered*.

A message *received by radio and sent forward by radio* counts as two messages *relayed* (one when received and again one when sent forward).

All messages counted under one of the three classes mentioned must be handled within a 48-hour (maximum) delay period to count as "messages handled." Messages for continents except North America may be held half the length of time it would take them to reach their destination by mail. A "service" message

# The Radio Amateur's Handbook . . . . .

counts the same as any other type of message.

## EXTRA DELIVERY CREDIT

In addition to the basic count of *one* for each time a message is handled by radio, an *extra credit* of one point for each delivery made by mail, telephone, in person, by messenger or other external means *other than use of radio* (which would count as a "relay" of course) will also be allowed. A message received by an operator for himself or his station or party on the immediate premises continues to count *only* "one delivered" as now, but a message for another amateur or third party delivered by an *additional means or effort* of the operator, in addition to such basic count, will receive a point under "extra delivery credits." Such extra credits must be reported separately from the other parts making up the total.

The message total shall be the *sum* of the messages originated, delivered and relayed and the "extra" delivery credits. Each station's message file and log shall be used to determine the report submitted by that particular station. Messages with identical texts (so-called rubber-stamp messages) shall count once only for *each* time the complete text, preamble and signature are sent by radio.

A.R.R.L. traffic totals may include all traffic handled on amateur frequencies with full data included by any standard form of message. Most messages you receive will be in standard A.R.R.L. form. But traffic in N.C.R. or A.A.R.S. form (when in drills or net operation using an amateur frequency) counts too, the principle being that when all essential data required by those agencies are included a message may be considered complete. In whatever volunteer work it is engaged, a station has an amateur status, and the total is a strictly "amateur" total if handled under ham-band conditions on amateur frequencies.

## Classify Your Amateur, A.A.R.S. and N.C.R. Traffic

● Traffic handled under a government (non-amateur) call, on a non-amateur-band frequency, should not be counted in "amateur" totals reported to S.C.M.s, but should be classified separately. Both the amateur total, and the "army" and "navy" totals, as the case may be, may be sent to your A.R.R.L. Section Manager, who invites these reports. Such totals must be clearly and separately classified, since in our B.P.L. it is our desire to avoid placing amateur-band work in direct competition with that accomplished on special frequencies.

Message texts should be transmitted *exactly* as received. Do not accept messages unless and until words are spelled out completely. No abbreviations in tests is an excellent rule. It is *not* a violation of good practice to change the *order* of preamble though, when traffic is transferred between services. Standard *amateur* procedure uses the land line check. The preamble goes NR-STN CALL-CK-PLACE OF ORIGIN-TIME-DATE. The NCR uses tactical procedure, and cable count check, which is a check including words (or groups) in address, text, and signature, customary in all maritime work.

## Examples of Counting

● A monthly report should be sent to the local A.R.R.L. S.C.M. The closing date of the "message month" is the 15th of each month (the last of the month in Hawaii and the Philippines). Reports must go forward the next day. Some examples:

Let us assume that on the 15th of the month one operator of a large amateur station receives several messages from another station. (a) Some of these messages are for relaying by radio. (b) Some of them are for local delivery. (c) There are still other messages the disposal of which cannot be accurately predicted. They are for the immediate neighborhood but either can be mailed or forwarded to another amateur by radio. A short-haul toll telephone call will deliver them but the chances of landing them nearer the destination by radio are pretty good. This operator's "trick" ends at midnight on the 15th and he must make the report with some messages "on the hook" to be carried over for the next month's report.

(a) The messages on the hook that are to be relayed have been received and are to be sent. They count as "1 relayed" in the report that is made out now, and they will also count as "1 relayed" in the next month's report (the month during which they were forwarded by radio).

(b) By mailing or 'phoning the messages at once, they count as "1 delivered" for the current report. By holding them until next day they will count in the *next* report as "1 delivered." Also they will each have a count of one *extra* delivery credit since they had to be phoned, mailed, etc.

(c) The messages in this class may be carried forward into the next month. If they *have* to be mailed then they will count in the *next* report as "1 delivered." If they are relayed, we count them as "1 relayed"; "1 received" in the preceding month (already reported) and "1 relayed" for the next month, the month in





# The Radio Amateur's Handbook . . . . .

the amateur. By carefully selecting material the members get the best magazine that can be made. *QST* is noted for its technical accuracy. "Breaking into print" in *QST* is an honor worth working for.

## Operating on Schedules

● Traffic handling work can be most advantageously carried on by arranging and keeping a few schedules. By arranging schedules and operating the station in a business-like way, using an accurate frequency meter and a clock, it has been proven many times that a maximum amount of business can be moved in a minimum of time and effort. The message "hook" can be cleared in a few minutes of work on schedule and the station will be free for DX or experimental work.

Every brass-pounder is urged to write letters to some of the reliable and regular stations heard, asking if some schedules cannot be kept a few times a week especially for traffic handling. The Route Manager is very frequently able to help in arranging schedules. Write your S.C.M. (see *QST*) and through him get lined up with your R.M. With reliable schedules in operation it is possible to advertise the fact that messages for certain points can be put through with speed and accuracy, and the traffic problem will take care of itself.

## The Five-Point System

● To make our relaying more systematic the "five-point system" of arranging schedules was proposed and has worked out very nicely in many cases. After getting the station in good operating condition, each station's operator arranges to work four stations, one north, one east, one south, and one west. These directions are not exact but general. The distances are not too great but they must be distances that can be worked with absolute certainty under any conditions.

A good way to select the four stations is to listen in and to pick out the stations heard most regularly, operating most consistently, and in the right direction. It is a good scheme to work these stations a few times. Write them letters and get acquainted; then try to arrange some schedules. Short schedules are the best. A half or quarter hour each day is enough. In an hour one can call four stations, clear traffic, and be free to work other groups of "five-pointers."

When there is no traffic, a few pleasantries

are in order during the scheduled time of working. Several advantages of handling messages on schedule are evident from whatever angle the situation is approached.

## Traffic Handling Develops Skill

● The dispatch of messages makes operators keen and alert. The better the individual operator, the better the whole organization. Proper form in handling traffic, getting fills, and in general operating procedure develops operators who excel in "getting results." Station performance depends 90% on operating ability, and 10% on the equipment involved, granting of course that station and operator are always interdependent. Experience in message handling develops a high degree of operating "intelligence."

Interest in relaying amateur radiograms has always been the important basic activity around which A.R.R.L. organization revolved. There are several good reasons why. Message handling leads to organization naturally, through the need for schedules and cooperation between operators. It offers systematic training in "real" operating. It leads to planned, useful, unselfish, constructive work for others at the same time it represents the highest form of operating "skill" and enjoyment to its devotees. Emphasis should be placed on the importance of traffic handling in training operators in the use of procedure — and in general operating reliability. The value of the amateur (as a group), in cases of local or national emergency, depends to a great extent on the *operating ability* of individual operators. This ability is largely developed in message handling work.

Practice in handling traffic familiarizes one with detailed time-saving procedure, and develops general skill and accuracy to a higher extent than obtains in "just rag-chewing" or haphazard work. This work provides a definite aim. Message handling is a vital link in guiding the interest of operators to the point where many accept additional responsibilities in the Signal Corps organization (A.A.R.S.), or the Volunteer Naval Communication Reserve (U.S.N.R.). The interest amateurs show in these services is directly reflected by a full measure of appreciation and important backing by Uncle Sam whenever amateur rights are threatened with encroachment of any kind. Message handling work represents an advanced form of amateur operating activity in which all amateurs sooner or later become interested.

# 21

## League Operating Organization

**Y**OUR A.R.R.L. does not aim to reform or change the hobby of the 'phone man, the DX man, the traffic enthusiast, rag chewer, or the experimenter. All hams should know all aspects of our hobby and be tolerant of the other fellow's viewpoint. Most hams do and are. Sooner or later, an amateur who starts in one branch of the game aspires to DX, 'phone, traffic, or use of the ultra-high frequencies, abandoning, at least for the time, his first interest in amateur radio. When a DX test is on many hams go after the DX fun thus made available by A.R.R.L., soon returning to their regular bent. It is our aim to benefit all concerned along the lines of natural interest.

By operating our stations with useful ends in view we can increase the pleasure we get, at the same time justifying our existence. Better communication results in all aspects of our hobby, amateur radio, can be achieved through better operating. The Communications Department is concerned with the practical operation of the stations of League members. Its work includes arranging amateur operating activities, establishing standard operating procedure, encouraging good operation, improving message relaying, and concluding tests to these ends.

The aim of the Communications Department is to keep in existence an active organization of League stations made entirely of privately-owned radio stations covering the entire continent of North America. One of its objectives is to create a body of skilled operators whose services and abilities will further the general knowledge of the art of radio communication. The relaying of friendly messages between different parts of the country without charge is one of the important phases of the work coming under the supervision of the Communications Department. Amateur operators have also always been of great assistance to our country in times of emergency in which quick communication has been a factor, especially when other methods of communication have failed.

These objects of our organization must be kept in mind at the same time we, as individ-

uals, are getting enjoyment from our chosen hobby.

The activities of the Communications Department are arranged and recorded through *QST* and by special correspondence. Tests and relays are arranged from time to time to develop new routes for traffic handling, to prepare ourselves to render emergency service in time of need, and to bring to light additional general radio information. In this way all members of the League benefit from the experience of certain individuals who excel along specified lines of work.

The policies of the Communications Department are those urging members to adopt uniform operating procedure and to use system in their station operating. The Communications Department constantly works to make our communication system as efficient as a non-commercial message-handling organization can be. Compliance with government regulations, orderly operating, and cooperation with each other and with outside interests for the advancement of the art are a part of its policies. The first duty of the department to member-stations is to supervise operating work so well that the amateur will continue to justify his existence in the eyes of his Government. Then he will be allowed a continuance of the privileges which he has received as his due in the past.

Records of tests are included in *QST*. Active stations in the A.R.R.L. organization receive special mimeographed bulletins on all new developments. Through such bulletins and a large volume of routine correspondence with individual members, the contact is kept good and the activities we have outlined are effectively carried out by the interested member-stations.

Official Broadcasting Stations have been appointed and regularly transmit addressed information to all amateurs by voice and in telegraphic code. This service of sending addressed messages to A.R.R.L. members on current matters of general interest is supplemented by official and special transmissions on timely subjects from Headquarters W1INF/W1MK (schedule is given on page 14).

# The Radio Amateur's Handbook . . . . .

In these pages we are going to explain the organization of the Communications Department, the proper message forms to use, and some special practices which experience has proved best. We urge that you help strengthen amateur radio by studying the operating practice suggested and by adopting uniform operating procedure.

Everyone at League Headquarters welcomes criticism that is accompanied by constructive suggestions. The fullest benefits of organization are realized only when every member participates freely in his organization and gives brother amateurs and his organization the benefit of his advice, suggestions, criticism, participation and cooperation in the common cause, amateur radio. In individual operating work as well, advancement comes as we learn to exchange constructive suggestions in the true amateur spirit.

In some department of the A.R.R.L.'s field organization there is a place for every active amateur who has a station. It makes no particular difference whether your interest lies in getting started and learning the code, traffic handling, DX, friendly contacts by phone, or other aspects of amateur radio. Whatever your qualifications, we suggest that you get into the game and cooperate with your Section Manager by sending him a monthly report of the

particular work you are doing. As you become experienced in amateur work of different kinds it is likely that you will qualify for appointment as O.R.S. or O.P.S. or that you can accept other important responsibilities in connection with the conduct of A.R.R.L. work in the different sections. Operating work and the different official appointments will be explained in detail in this and the following chapter. We want to make it clear right at the start that the Communications Department organization exists to increase individual enjoyment in amateur radio work, and we extend a cordial invitation to every amateur and reader of this book to participate fully in the different enterprises undertaken by and for amateur operators.

## Organization

● The affairs of the Communications Department in each Division are supervised by one or more Section Communications Managers, each of whom, elected by the A.R.R.L. members of his territory, has jurisdiction over his section of Division.

For the purpose of organization the A.R.R.L. divides the United States and Possessions (plus Cuba and the Isle of Pines) and Canada (plus Newfoundland and Labrador) into divisions as follows:



# . . . . . League Operating Organization

**ATLANTIC DIVISION:** Delaware, District of Columbia, Maryland, Pennsylvania, that section of New Jersey within the Third Federal Inspection District, and that section of New York within the Eighth Federal Inspection District.

**CENTRAL DIVISION:** Illinois, Indiana, Kentucky, Michigan, Ohio and Wisconsin.

**DAKOTA DIVISION:** Minnesota, North Dakota and South Dakota.

**DELTA DIVISION:** Arkansas, Louisiana, Mississippi and Tennessee.

**HUDSON DIVISION:** The entire Second Federal Inspection District, consisting of certain counties of New Jersey and New York States.

**MIDWEST DIVISION:** Iowa, Kansas, Missouri and Nebraska.

**NEW ENGLAND DIVISION:** Connecticut, Maine, Massachusetts, New Hampshire, Rhode Island and Vermont.

**NORTHWESTERN DIVISION:** Idaho, Montana, Oregon, Washington and the Territory of Alaska.

**PACIFIC DIVISION:** That portion of the state of California not included in the Southwestern Division, Nevada, the Territory of Hawaii and the Philippine Islands.

**ROANOKE DIVISION:** North Carolina, Virginia and West Virginia.

**ROCKY MOUNTAIN DIVISION:** Colorado, Utah and Wyoming.

**SOUTHEASTERN DIVISION:** Alabama, Florida, Georgia, South Carolina and the Island of Porto Rico. (*The Republic of Cuba and the Isle of Pines are attached to this Division for Communications Department activities.*)

**SOUTHWESTERN DIVISION:** The counties of Imperial, Inyo, Los Angeles, Mono, Orange, Riverside, San Bernardino, San Diego, San Luis Obispo, Santa Barbara and Ventura of the state of California, and the state of Arizona.

**WEST GULF DIVISION:** New Mexico, Oklahoma and Texas.

**MARITIME DIVISION:** The provinces of New Brunswick, Nova Scotia and Prince Edward Island. (*Newfoundland and Labrador are attached to this Division for Communications Department activities.*)

**ONTARIO DIVISION:** Province of Ontario.

**QUEBEC DIVISION:** Province of Quebec.

**VANALTA DIVISION:** Provinces of Alberta and British Columbia and Yukon Territory.

**PRAIRIE DIVISION:** Provinces of Manitoba and Saskatchewan and the Northwest Territories.

Each United States Division elects a Director to represent it on the A.R.R.L. Board of

Directors and the Canadian Divisions elect a Canadian General Manager who is also a Director. The Board determines the policies of the League.

## A.R.R.L. Sections

● The map on a preceding page shows both Divisions and Sections in the League's field organization. A.R.R.L. territory is subdivided into Sections to facilitate the efficient supervision of activities and appointments in the field organization.

The field officials (S.C.M.s) and the names and addresses of the Directors are printed in each *QST*.

Whenever a vacancy occurs in the position of Section Communications Manager in any section of the United States, its island possessions or territories, or the Republic of Cuba, the Communications Manager announces such vacancy through *QST* or by mail notice to all members of the Section, and calls for nominating petitions signed by five or more members of the Section in which the vacancy exists, naming a member of the Section as candidate for Section Communications Manager. The closing date for receipt of such petitions is announced.

After the closing date, the Communications Manager arranges for an election by mail or declares any eligible candidate elected if but one candidate has been nominated. Ballots are sent to every member of the League residing in the Section concerned, listing candidates in the order of the number of nominations received. Section Communications Managers are elected for a two-year term of office.

The office of any Section Communications Manager may be declared vacant by the Executive Committee upon recommendation of the Communications Manager, with the advice and consent of the Director, whenever it appears to them to be in the best interests of the membership, and they may thereupon cause the election of a new Section Communications Manager.

## Communications Department Officials and Appointments

● These S.C.M.s elected in each Section by the A.R.R.L. members in that Section, appoint active qualified amateur stations for special types of radio work in the A.R.R.L. field organization. Whether your activity is directed toward DX, experimenting, 'phone or traffic, there is a place for you in League work. Your S.C.M. welcomes a monthly report from every active ham. The following regulations will explain the duties of the S.C.M. and the special-

ized radio work of all stations honored by holding A.R.R.L. appointments.

## Section Communications Manager

● 1. The Section Manager shall appoint Route Managers, 'Phone Activities Managers, Official Observers, Official Broadcasting Stations, Official Relay Stations, Official 'Phone Stations, and individuals and/or stations for specific work in accordance with the qualifications and rules for such appointments. He shall likewise make cancellations of appointments whenever necessary.

Appointees shall have full authority within the section over the activities indicated by their titles. They will report and be responsible to the Section Communications Manager for their work. With the consent of the Communications Manager the Section Manager may, if necessary, designate a competent League member to act for him in a particular matter in any part of his territory. He shall be careful to instruct such an appointee properly in the duties he is to execute while acting for the S.C.M.

2. His territorial limitations are determined by the Division Director (or C.G.M.) and the Communications Manager.

3. The Section Manager is responsible to the Communications Manager at League Headquarters for maintenance of records of all his appointments, and cancellations of such appointments either for violations of the regulations under which these are issued, or for violations of the F.C.C.'s amateur regulations. The Form 4 (appointment) and Form 4C (cancellation) cards provided must be sent to Headquarters that A.R.R.L. mailing lists and records may be kept exactly in accordance with those of the S.C.M. office. Annual endorsement of O.R.S. and O.P.S. certificates (and S.C.M. notification — to Headquarters by Form 4) is required to keep these appointments in effect.

4. The Section Manager is responsible for the coöperation of active station-owners in A.R.R.L. activities, contests, traffic work, etc. and is authorized to devise and develop special plans in the furtherance of Section interest and esprit de corps.

5. The Section Manager is the Section executive. His leadership must take into consideration the proper distribution of basic and key appointments to those best qualified in the different cities and in each radio club in the Section. Such problems as the geographical distribution and coverage of stations (OBS) sending addressed information to members, the distribution of appointments in the different

frequency bands for effective Section activities require careful study. The S.C.M. must in his decisions try to grant recognition to the best qualified operators and stations, and endeavor to insure A.R.R.L. representation and activity in each amateur group.

6. The S.C.M. may appoint *only League members* to any A.R.R.L. office. He must see that each O.R.S. and O.P.S. appointed has the proper qualifications, as indicated by actual operating radio tests and/or station inspection made by him or under his direction. The S.C.M. shall also conduct investigations of radio organizations and interference cases whenever such cases are referred to him by Headquarters or the Division Director. It is his duty to demonstrate Section leadership and coördinate all types of amateur operating work to make his Section as effective and active as possible.

7. The S.C.M. may requisition necessary Communications Department supplies provided for making appointments and supervising the work in his section. He may render an itemized postage expense account at intervals, for reimbursement. Section Managers are entitled to wear the distinctive A.R.R.L. pin with red background, similar in other respects to the regular black-and-gold A.R.R.L. membership pin.

8. The S.C.M. shall render a monthly report or activity summary to Headquarters. It shall be made up from all reports from all active stations, whether members or not, and include comprehensive information on each appointee. Reports shall be mailed to Headquarters by S.C.M.s on or before the 20th of the reporting month (16th to the 15th inclusive) in the mainland U. S. A. and Canada.

## Official Observers

● Do you need a frequency check? Each volunteer observer is appointed by his S.C.M. to help all hams keep on the assigned frequencies and assist brother amateurs by calling attention to improper broadness, a.c. notes, poor spacing, violations of good practice, over-modulation, poor speech quality, etc., in the right way to obtain maximum coöperation in bettering operating conditions. Official Observers, to receive appointment must have an accurate frequency meter, or oscilloscope, or other equipment suitable for accurate observing work of the type in which he intends to specifically engage.

Each S.C.M. recommends for appointment one or more Observers who report regularly to the S.C.M. on off-frequency operation noticed, sending out notification forms (provided from

# . . . . . League Operating Organization

Headquarters) to help amateurs in keeping within the assigned bands.

Observers' frequency meters shall be checked regularly against A.R.R.L. Standard Frequency Station transmissions and by government or commercial "marker" stations of known frequency operating adjacent to our own amateur channels. Observers are provided with notification postal card forms and report blanks. The stations notified are reported to A.R.R.L. (through the office of the S.C.M.) as rapidly as the blanks are filled out. Radio contacts with off-band stations shall be made by O.O.s wherever possible. Operators in different bands are needed to specialize on conditions in those bands, 'phone observers to help improve 'phone operating conditions, etc.

Observers also shall report harmonic or parasitic radiations and other operation of commercial or government telegraph services or broadcasting stations causing interference in the amateur bands, these being reported direct to Headquarters as promptly as possible so that remedial action may be taken.

The notification service to amateurs is designed as a friendly move to protect amateur privileges from official government restrictions. These are invited by careless or intentional disregard of regulations by individuals who may thus jeopardize the enjoyment of all amateurs. Observers also report all flagrant violations of good amateur practice, including improper procedure, poor spacing, "a.c." notes, unstable signals, overmodulation, unethical "music" broadcasting, or other abuses; all to the end that these things may be brought before the operators concerned, the effectiveness of stations improved, and high standards of amateur operating maintained. Observers also make station-distribution surveys showing actual density of stations and operating conditions in our different amateur bands.

## Route Managers

● The Route Manager is the authority on schedules and routes and his station must be active in traffic and organization work. Section Managers generally appoint one Route Manager to every twenty or twenty-five Official Relay Stations. The Route Manager's duties include cooperation with all radio amateurs in his territory in organizing and maintaining traffic routes, nets, and schedules. His authority extends to station inspection and/or radio operating tests of candidates for O.R.S. appointment as directed by the S.C.M. Each R.M.'s territory and jurisdiction over special projects is determined by the S.C.M. who expects monthly progress reports. R.M.s may

wear the League emblem with the distinctive deep-green background.

Special appointments are made of N.C.R. Liaison and A.A.R.S. Liaison Route Managers



to link these systems and League organization in each Section. Since some reservists seem unaware that traffic handled in drills, on amateur frequencies, counts in A.R.R.L. totals, such appointments help all organizations work well together. The duties of such "liaison" R.M.s include getting reports from N.C.R. or A.A.R.S., and telling hams more about these organizations.

## 'Phone Activities Manager

● The 'Phone Activities Manager has authority to sponsor 'phone operating activities in his territory, in the name of the League. The P.A.M. appointment, while paralleling that of R.M. in some respects, has nothing to do with "traffic" organizing whatsoever, but with the

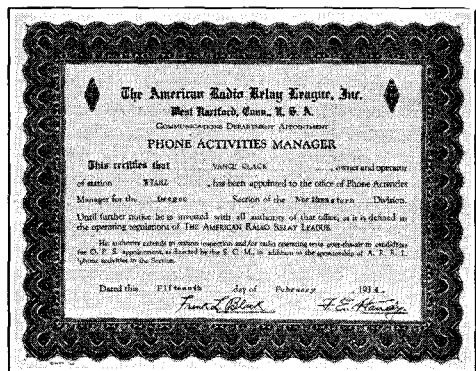

upbuilding of A.R.R.L. Section and National 'phone organization. The 'Phone Activities Manager conducts station inspections and/or radio operating tests of candidates for O.P.S.

# The Radio Amateur's Handbook . . . . .

appointment as directed. P.A.M.s wear the League emblem with the distinctive deep-green background in recognition of their official status.

## Official Broadcasting Station

● The Official Broadcasting Station transmits information on timely subjects addressed to radio amateurs and A.R.R.L. members. This must be sent at scheduled times during the week following receipt of the information from A.R.R.L. Headquarters.

Applicants for this appointment must submit their qualifications to the Section Manager with the proposed dates, times and frequencies for transmission of the broadcasts. In deciding on the times of transmission schedules, preference should be given to those times when the largest number of amateurs are listening, that is, the hours between 6:00 p.m. and midnight. Station power, geographical location, frequent transmissions, ability to copy messages direct from W1INF/W1MK in advance of mail, should all receive consideration by S.C.M.s in making appointments. Section Managers are instructed to cancel the appointments of stations not adhering to the schedules agreed upon, and the appointments of stations not returning information on current or revised schedules when periodic surveys of the broadcasting system are made.

## Basic A.R.R.L. Appointments

● Both Official Relay Station and Official 'Phone Station appointees receive an appointment certificate to be displayed in the station, a quarterly bulletin from Headquarters, and Form 1 reporting cards on which to turn in the monthly reports to the Section Communications Manager.

Appointment certificates (O.R.S. and/or O.P.S.) must be returned to Section Managers annually for proper endorsement to keep these in effect more than one year. Any applicant who fails to qualify may again apply for appointment after three months have elapsed. In making application, forms indicating knowledge of recommended procedure must be filed with the S.C.M. on blanks available from each S.C.M. office. New applicants must communicate *by radio* with a Section official and receive approval of this official or his representative. Operators with personal responsibility and high standards of operating are recognized as O.R.S. and O.P.S., and appointed to these important basic posts in A.R.R.L. organization because they have the qualifications. As a result of operating appointments carefully supervised and given only to active men with

demonstrated ability in technical and operating matters, the present effective field organization, in successful operation for many years, is maintained.

It is the duty of Official Relay Station and Official 'Phone Station appointees (a) to report activities monthly to the S.C.M., whether or not a special reporting form is available; (b) to keep stations always on the air, i.e., in readiness for operation and in actual service; (c) to follow A.R.R.L. operating practices; (d) to take part in the activities of the League whenever possible; (e) to hold message files three months ready for any call by the S.C.M. or licensing authority. *Reports are due on the 16th of each month for mainland United States stations.*

O.R.S. and O.P.S. appointments are not transferable from one station-owner to another. When an appointee moves they may be transferred from one Section to another by arrangement with the S.C.M.s concerned who notify Hq. of cancellation and re-appointment. Appointments may be cancelled by S.C.M.s whenever three consecutive reports are missed, and evidence of regular work and reports for three months must be submitted before such a station may be reinstated. "Earned reinstatements" may be made within one year without filing new application papers. After this the filing of new application papers is desirable, and discretionary with the Section Manager.

## The Official 'Phone Station Appointment

● This appointment is for every qualified ham who normally uses his "mike" more than his key in his amateur station, and who takes a



pride in the manner of signal he puts on the air, and aims to have his station really accomplish worthwhile communication work. Official 'Phone Station appointees must endeavor to live up to the Amateur's Code of good frater-



## . . . . . *League Operating Organization*

nalism and operating equality. The appointment gives 'phone operators the advantages of organization for systematic coöperation in emergencies, quarterly bulletin news, and operating tests. *O.P.S. appointment does not stress traffic handling by voice*, but aids 'phone operating enjoyment by helping to formulate good voice operating practices, not overlooking the emergency organization aspect. The operating standards established make voice work more enjoyable and systematic.

1. O.P.S. use circuit precautions that avoid frequency-modulation and overmodulation, and employ indicators in their transmitters to detect maladjustments.

2. O.P.S. coöperate with each other, and with all amateurs, regardless of power, or frequency. No "monopolization" of a frequency channel by an individual operator is permissible, excepting such a situation is demanded by emergency conditions at a station in an isolated area.

3. Major adjustment of transmitters is completed outside of heavy operating hours.

(No needless music playing under the guise of legitimate testing to increase QRM and constitute an exhibition of selfishness. Such tests should be performed using dummy antennas, and radiating antennas connected only for bona fide voice communication.)

4. O.P.S. endeavor at all times to make the operation of their stations an example to be looked up to by other amateurs; they will stand ready to assist other amateurs in observing frequency bands, in complying with F.C.C. regulations, in adopting and furthering common sense, effective, voice operating procedure as formulated and codified by the group of O.P.S. for the benefit of all, and the furtherance of radiotelephone work.

All operators who use voice should use the suggestions codified to improve operating conditions in the 'phone bands. Official 'Phone Station appointment differs from O.R.S. appointment in that the operators are *not appointed specifically to handle traffic*. Of course when traffic is handled these stations observe the same high standards of responsible operating work; they will therefore at all times coöperate with S.C.M.s and R.M.s by prompt dispatch or delivery of any traffic that may be sent via the 'phone bands. Stations holding O.P.S. appointment will, of course, insist on complete addresses, and give city of origin and number each message carefully in accordance with A.R.R.L. procedure.

The application for O.P.S. appointment does not require a 15-w.p.m. code speed such as prescribed in the test for O.R.S. applicants. Applicants must have had at least one year of amateur operating experience. A description of the station for which appointment is sought must be given the S.C.M. If the arrangement meets modern technique, if the operating experience is adequate, and if the adjustment of the station checked by inspection, or test over the air, is also approved, the A.R.R.L.-O.P.S. appointment may be granted by the S.C.M. and Headquarters so notified at the same time

the appointee receives his certificate. The station signal, and its operation too, must meet satisfactory standards. Appointments may be cancelled for inactivity, or failure to meet prescribed qualifications (like all other A.R.R.L. appointments) to make the O.P.S. appointment really stand for something worth while to all voice-operated amateur stations.

A 'Phone Activities Manager may assist the S.C.M. in necessary station inspection or test-over-the-air for O.P.S. applicants.

This appointment is for every live-wire operator of a first class 'phone, working any 'phone band. Like all other C.D. appointments, one makes application to the Section Communications Manager for O.P.S. appointment, and receives the necessary application forms. A certificate of appointment is issued by the S.C.M. if and when an appointment is granted. Appointments are issued good for one year, but must be kept in effect by activity and annual endorsement by the S.C.M.

If you have a year or more of radiotelephone operating experience behind you, and a well adjusted voice station of modern technique on the air, this is a cordial invitation to you to get in touch with your Section Manager. Tell him you are interested in the Official 'Phone Station appointment; ask him for application forms.

### The Official Relay Station Appointment

● Every radio telegraphing amateur interested in traffic work and worthwhile operating organization activities who can meet the qualifications is eligible for appointment of his station as A.R.R.L. Official Relay Station. Brasspounders handle traffic because they enjoy such work. There is fun in efficient operation; pride in accomplishing something; opportunity to demonstrate operating proficiency at the same time this is maintained and increased. The potential value of the operator who handles traffic to his community and country is enhanced by his ability, and the readiness of his station and schedules to function in the community interest in case of emergency. Operators with good signals and personal responsibility toward the communications they handle seek and hold Official Relay Station appointment. Traffic-awareness is often the sign by which mature and experienced amateurs may be distinguished from newcomers to the ranks of hamdom.

1. O.R.S. must be able to transmit and receive at least 15 words per minute.

2. O.R.S. coöperate with each other, and with all amateurs. They must make their stations and operating an example to other amateurs. They must follow standard

# The Radio Amateur's Handbook . . . . .

A.R.R.L. operating practices (use proper message form, finish signals, misc. abbreviations, etc).

3. Appointees must keep a transmitter and receiver in operative condition at all times. Consistent activity is required to keep appointments in effect and must be demonstrated by regular reports to the S.C.M.

4. O.R.S. must display a high degree of interest in relay traffic activities, nets, schedules, trunk lines, and such.

O.R.S. are the "minute men" of amateur radio — always organized, reporting, active, and holding their equipment in tip-top condition ready for instant service on any communi-

be necessary. But you must be willing to accept a certain amount of "personal responsibility" in regard to regular reporting each month, and absolute reliability in forwarding and delivering a number of messages regularly through your station. The appointment is one made with advantage to yourself. Fill out the application form as soon as you can qualify!

## An Invitation

● Any A.R.R.L. member who has a station and operator's license and wants to "do things" with his equipment will find it easy and very much worth while to earn an appointment in the Communications Department organization. As has been explained, knowledge and use of certain fundamentals of operating procedure are prerequisite to appointment to the important basic posts in our field organization. Study procedure. Put into practice the things that you read. Originate and relay some traffic regularly. Keep a few schedules with other amateurs. Report all your activities on time (the 16th) each month to your S.C.M. whose address is given in each *QST*, to prove your qualifications and interest. Regardless of whether you have yet applied for appointment, a postal to the S.C.M. will give him information to use in his report for *QST* and boost the standing of your station and Section.

"Being active" in amateur work should not mean sacrificing all the varied interests we have as individuals. A few hours daily spent in *planned* radio work, a postal to our S.C.M. once each month about our activities, and including traffic handled, gives us credit for all we attempt, contact with and news from fellow hams through *QST*, and adds the touch that makes the difference between organized ham radio and merely haphazard unchronicled work. All reports summed up, make the record for Section and Division. There are many kinds of amateur work; each has its benefits and its leaders. Friendships, DX, technical knowledge, proficiency in construction, ability to operate or communicate, all are important. Interest in a special phase of amateur work is all right if moderation is observed.

The well-balanced amateur will not only know how to handle a message, but will have extended the principles of neatness and efficiency to his other station activities. The complete amateur station includes attention to traffic matters as part of its regular routine; it is one essential in building a reputation for "reliability" in amateur work. Communication (general) involves an exchange of thoughts. "Traffic" is merely the exchange of thoughts for ourselves or others using messages as a



ating problem, large or small. Official Relay Stations are, as the name implies, stations that can be depended on absolutely to see a hard job through. They are ready for every opportunity of service to the public or amateur radio that may come their way, whether a special emergency, test, experiment, or just in the line of ordinary operation. They deliver and relay promptly all traffic that comes their way. O.R.S. appointment is highly significant since it puts the station owner in a special position as respects the opportunities of service. The appointment certificate also has come to be known as the badge that shows an amateur station has "arrived" in the dependable class.

O.R.S. appointees are entitled to wear the distinctive blue A.R.R.L. pin which is similar to the regular membership pin except that it has a blue instead of a black background.

To secure an appointment as Official Relay Station is quite a simple matter if you have the qualifications and a little experience. After building the station, gaining some code speed, and reporting your activities to the S.C.M. as suggested, ask the S.C.M. to furnish you with an application for appointment as Official Relay Station (or use the one printed for your convenience in the rear of this book). The S.C.M. will be glad to send you the necessary forms to be filled out and returned to him, and to give you advice on the application as may

# . . . . . League Operating Organization

simple medium to get the thought "exact and concise." The development of systematic habits of work is beneficial and may extend to fields other than amateur radio with profit also. To get full value from amateur organization work you must take part in such work. The different appointments have been explained. If your station is active you are invited to qualify and take part fully in A.R.R.L. work.

## The "Worked All States" Club

A.R.R.L. certificates are available for those radio amateurs who "Work all forty-eight of the United States." Just as WAC means "Worked All Continents," WAS means "Worked All States." This award is available to amateurs the world over regardless of affiliation or non-affiliation with any organization. Here are the few simple rules to qualify:

- (1) Two-way communication must be established on the amateur bands with all forty-eight United States; any and all amateur bands may be used. The Dist. of Columbia also counts for Maryland as it was a part of that state once.
- (2) Contacts with all forty-eight states must be made from the same location. Within a given community one location may be defined as from places no two of which are more than 25 miles apart.
- (3) Contacts may be made over any period of years, and

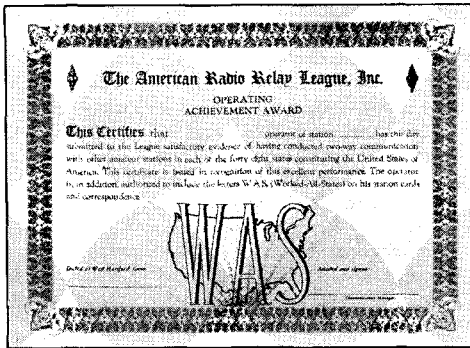

may have been made any number of years ago, provided only that all contacts are from the same location.

- (4) Forty-eight QSL cards, or other written communication confirming two-way contacts made (one from each state) must be submitted to A.R.R.L. headquarters.
- (5) Sufficient postage must be sent with confirmations for their return. No correspondence will be returned unless sufficient postage is furnished.
- (6) The W.A.S. award is available to all amateurs everywhere in the world.
- (7) Address applications and confirmations to Communications Department, A.R.R.L., 38 LaSalle Road, West Hartford, Conn.

Check up *today* on the states you have worked and those from which you have received acknowledgments. List the missing states and go after QSO's with them. You will find it a very considerable operating achieve-

ment — one that a select few hams can boast. How complete is your coverage? The certificate which attests to your accomplishment is ready and will be forwarded when the cards and data from all 48 states have been examined. There is no better time to start going after WAS than *now*.

## W.A.C. for DX Operators

● In collaboration with the I.A.R.U. the A.R.R.L. issues W.A.C. (Worked All Continents) certificates to those member-amateurs whose DX achievements include two way communication on the ham bands with at least one other amateur station on each continent. It is only necessary to submit six QSL cards, one showing such communication with each *continent*, as proof of world-wide contacts, to receive this recognition for DX work. It is considered easier to become W.A.C. than W.A.S. since there are fewer localities necessary to be "worked" but both are first class operating achievements that show operator and station excellence! Go after these "attainment" awards!

## Trunk Lines

● A.R.R.L. Trunk Lines to facilitate speedy and reliable traffic movement are maintained during each active radio season. These "main-line" routes are laid out East-West and North-South and connect with countless local networks and schedule chains. There are fourteen main lines, each operating on a separate "spot frequency" in the 3.5-mc. amateur band.

Every station on the main lines must be an Official Relay Station and must be crystal controlled. Each Trunk Line Station on the main routes must have an alternate to take over schedules whenever the regular station cannot be on the air. All these stations must maintain trunk line schedules at least five days per week. If you are interested in trunk line work, get your O.R.S. appointment first. Then drop a line to the Communications Department stating your availability for trunk line schedules. You will then be advised of any openings.

## Radio Clubs

● To add to the strength and unity of amateur radio, to improve understanding and coöperation, to promote technical discussions, to solve interference problems locally and quell bootleg or illegal operation in each community, there is nothing like a local radio club which is on the job. The American Radio Relay League believes in radio clubs and offers to any individual organizers of new amateur associations in different localities a wealth of

# The Radio Amateur's Handbook . . . . .

information gleaned from contacts and experience and compiled to assist in club organization work. Papers on club work, suggestions for organizing, for constitutions, for radio courses of study, etc., are available in mimeographed form free on request.

## Affiliation

● In addition it is the policy of the League to grant affiliation to any amateur society having 51 percent of its licensed amateurs also members of the A.R.R.L. which suitably expresses its sympathy with and allegiance to the aims and policies of the League as determined by its Board of Directors, and which society, on investigation, receives the approval of the Division Director having jurisdiction. It is the constant aim of the A.R.R.L. to maintain a bond of affiliation with local radio societies of kindred aims and purposes, since at different times in the League's history this has made possible unity of action and strength in proceeding by various channels to represent amateur views successfully and forcefully in legislative and regulatory matters. The necessary forms for initiation of action looking toward affiliation with A.R.R.L. will be forwarded to any existing amateur society on application. Affiliated club news is recorded in a special department maintained in *QST* for the purpose. Achievement certificates are awarded by A.R.R.L. to club members participating in the annual DX and Sweepstakes contests, where three or more affiliated club members report participation. Such awards are signed both by the Club and by A.R.R.L. Special price schedules on A.R.R.L. supplies apply to the affiliated radio clubs.

## A.R.R.L. Headquarters' Station W1INF/W1MK

● Supplementing the hamming of individual A.R.R.L. staff members from their own stations, the League's Board acceded to the demand of members for a powerful Headquarters station, which was placed in operation in February, 1928. All amateurs are familiar with the outstanding station operated regularly and of late years employing two one kilowatt transmitters on different amateur bands as W1MK. This station has been pictured in previous Handbooks. The equipment and many accomplishments of this station will not be described again here since both are fully known to all active amateurs. In March 1936,

this station was completely flooded in the unprecedented floods. A small part of the equipment was saved, and some salvaged requiring a complete rebuilding and abandonment of the old location which was seven miles from the Headquarters offices near the Connecticut River.

Station W1INF, operated informally in '35 and '36 by the Headquarters Operators Club on 75- and 20-meter 'phone was at once modified for telegraph work on the official Headquarters station frequencies 3825/3575 kcs. and 7150 kcs., picking up the operating schedules as well as the constant speed tape transmissions addressed two or more times to radio amateurs each night of operation (see full schedule, page 14) as soon as the rescued automatic tape equipment could be installed.

At the 1936 Board meeting the Directors appropriated a substantial sum for a permanent site of a new and effective Headquarters station and building to be erected and operated as a living memorial to the League's founder, Mr. Hiram Percy Maxim. Plans for this station include the building of separate units for each frequency band with capability for operation by voice or telegraph as well as continuation of the functions of the station as key station in the League's OBS system and important leadership in message handling and general service to all amateurs and League organization. Site for the new station cannot be chosen until a committee studying all factors of Headquarters location reports to the Board. In the meantime rebuilding is gradually progressing on some units at the same time the usual operating program is continued through W1INF/W1MK.

The Signal Corps has authorized your Headquarters station (as W1MK) to use 3497½ and 6990 kcs. facilitating preparedness for any communications emergency.

Until the "memorial station" is completed, your Headquarters is operating W1INF at the present offices and aiming to do the best operating job feasible, adding units insofar as possible in view of space and power limitations. W1INF is a busy station. You will hear it keeping schedules, sending you "the latest" on amateur regulations and activities. Chief Operator "Hal" or whoever is at the switch is always ready for a call from any ham. We cordially invite members to "look in" on their station at any time and see how the new plans are developing.

# Appendix

## THE "Q" CODE

IN THE REGULATIONS accompanying the existing International Radiotelegraph Convention there is a very useful internationally agreed code designed to meet major needs in international radio communication. This code follows. The abbreviations themselves have the meanings shown in the "Answer" column. When an abbreviation is followed by an interrogation mark (?) it assumes the meaning shown in the "question" column.

<i>Abbreviation</i>	<i>Question</i>	<i>Answer</i>
QRA	What is the name of your station?	The name of my station is . . . . .
QRB	How far approximately are you from my station?	The approximate distance between our stations is . . . . . nautical miles (or . . . . . kilometres).
QRC	What company (or Government Administration) settles the accounts for your station?	The accounts for my station are settled by the . . . . . company (or by the Government Administration of . . . . .).
QRD	Where are you bound and where are you from?	I am bound for . . . . . from . . . . .
QRG	Will you tell me my exact frequency (wave-length) in kc/s (or m)?	You exact frequency (wave-length) is . . . . . kc/s (or . . . . . m).
QRH	Does my frequency (wave-length) vary?	Your frequency (wave-length) varies.
QRI	Is my note good?	Your note varies.
QRJ	Do you receive me badly? Are my signals weak?	I cannot receive you. Your signals are too weak.
QRK	Do you receive me well? Are my signals good?	I receive you well. Your signals are good.
QRL	Are you busy?	I am busy (or I am busy with . . . . .). Please do not interfere.
QRM	Are you being interfered with?	I am being interfered with.
QRN	Are you troubled by atmospherics?	I am troubled by atmospherics.
QRO	Shall I increase power?	Increase power.
QRP	Shall I decrease power?	Decrease power.
QRQ	Shall I send faster?	Send faster (. . . . . words per minute).
QRS	Shall I send more slowly?	Send more slowly (. . . . . words per minute).
QRT	Shall I stop sending?	Stop sending.
QRU	Have you anything for me?	I have nothing for you.
QRV	Are you ready?	I am ready.
QRW	Shall I tell . . . . . that you are calling him on . . . . . kc/s (or . . . . . m)?	Please tell . . . . . that I am calling him on . . . . . kc/s (or . . . . . m).
QRX	Shall I wait? When will you call me again?	Wait (or wait until I have finished communicating with . . . . .) I will call you at . . . . . o'clock (or immediately).
QRY	What is my turn?	Your turn is No. . . . . (or according to any other method of arranging it).
QRZ	Who is calling me?	You are being called by . . . . .
QSA	What is the strength of my signals (1 to 5)?	The strength of your signals is . . . . . (1 to 5).
QSB	Does the strength of my signals vary?	The strength of your signals varies.

# The Radio Amateur's Handbook . . . . .

Abbre- viation	Question	Answer
QSD	Is my keying correct; are my signals distinct?	Your keying is incorrect; your signals are bad.
QSG	Shall I send . . . . . telegrams (or one telegram) at a time?	Send . . . . . telegrams (or one telegram) at a time.
QSJ	What is the charge per word for . . . . . including your internal telegraph charge?	The charge per word for . . . . . is . . . . . francs, including my internal telegraph charge.
QSK	Shall I continue with the transmission of all my traffic, I can hear you through my signals?	Continue with the transmission of all your traffic, I will interrupt you if necessary.
QSL	Can you give me acknowledgement of receipt?	I give you acknowledgement of receipt.
QSM	Shall I repeat the last telegram I sent you?	Repeat the last telegram you have sent me.
QSO	Can you communicate with . . . . . direct (or through the medium of . . . . .)?	I can communicate with . . . . . direct (or through the medium of . . . . .).
QSP	Will you retransmit to . . . . . free of charge?	I will retransmit to . . . . . free of charge.
QSR	Has the distress call received from . . . . . been cleared?	The distress call received from . . . . . has been cleared by . . . . .
QSU	Shall I send (or reply) on . . . . . kc/s (or m) and/or on waves of Type A1, A2, A3, or B?	Send (or reply) on . . . . . kc/s (or . . . . . m) and/or on waves of Type A1, A2, A3, or B.
QSV	Shall I send a series of VVV . . . . .?	Send a series of VVV . . . . .
QSW	Will you send on . . . . . kc/s (or . . . . . m) and/or on waves of Type A1, A2, A3 or B?	I am going to send (or I will send) on . . . . . kc/s (or . . . . . m) and/or on waves of Type A1, A2, A3 or B.
QSX	Will you listen for . . . . . (call sign) on . . . . . kc/s (or . . . . . m)?	I am listening for . . . . . (call sign) on . . . . . kc/s (or . . . . . m).
QSY	Shall I change to transmission on . . . . . kc/s (or . . . . . m) without changing the type of wave? or Shall I change to transmission on another wave?	Change to transmission on . . . . . kc/s (or . . . . . m) without changing the type of wave or Change to transmission on another wave.
QSZ	Shall I send each word or group twice?	Send each word or group twice.
QTA	Shall I cancel telegram No. . . . . as if it had not been sent?	Cancel telegram No. . . . . as if it had not been sent.
QTB	Do you agree with my number of words?	I do not agree with your number of words; I will repeat the first letter of each word and the first figure of each number.
QTC	How many telegrams have you to send?	I have . . . . . telegrams for you (or for . . . . .).
QTE	What is my true bearing in relation to you? or What is my true bearing in relation to . . . . . (call sign)? or What is the true bearing of . . . . . (call sign) in relation to . . . . . (call sign)?	Your true bearing in relation to me is . . . . . degrees or Your true bearing in relation to . . . . . (call sign) is . . . . . degrees at . . . . . (time) or The true bearing of . . . . . (call sign) in relation to . . . . . (call sign) is . . . . . degrees at . . . . . (time).

# Appendix

Abbreviation	Question	Answer
QTF	Will you give me the position of my station according to the bearings taken by the direction-finding stations which you control?	The position of your station according to the bearings taken by the direction-finding stations which I control is ..... latitude ..... longitude.
QTG	Will you send your call sign for fifty seconds followed by a dash of ten seconds on ..... kc/s (or ..... m) in order that I may take your bearing?	I will send my call sign for fifty seconds followed by a dash of ten seconds on ..... kc/s (or ..... m) in order that you may take my bearing.
QTH	What is your position in latitude and longitude (or by any other way of showing it)?	My position is ..... latitude ..... longitude (or by any other way of showing it).
QTI	What is your true course?	My true course is ..... degrees.
QTJ	What is your speed?	My speed is ..... knots (or ..... kilometers) per hour.
QTM	Send radioelectric signals and submarine sound signals to enable me to fix my bearing and my distance.	I will send radioelectric signals and submarine sound signals to enable you to fix your bearing and your distance.
QTO	Have you left dock (or port)?	I have just left dock (or port).
QTP	Are you going to enter dock (or port)?	I am going to enter dock (or port).
QTQ	Can you communicate with my station by means of the International Code of Signals?	I am going to communicate with your station by means of the International Code of Signals.
QTR	What is the exact time?	The exact time is .....
QTU	What are the hours during which your station is open?	My station is open from ..... to .....
QUA	Have you news of ..... (call sign of the mobile station)?	Here is news of ..... (call sign of the mobile station).
QUB	Can you give me in this order, information concerning: visibility, height of clouds, ground wind for ..... (place of observation)?	Here is the information requested .....
QUC	What is the last message received by you from ..... (call sign of the mobile station)?	The last message received by me from ..... (call sign of the mobile station) is .....
QUD	Have you received the urgency signal sent by ..... (call sign of the mobile station)?	I have received the urgency signal sent by ..... (call sign of the mobile station) at ..... (time).
QUF	Have you received the distress signal sent by ..... (call sign of the mobile station)?	I have received the distress signal sent by ..... (call sign of the mobile station) at ..... (time).
QUG	Are you being forced to alight in the sea (or to land)?	I am forced to alight (or land) at ..... (place).
QUH	Will you indicate the present barometric pressure at sea level?	The present barometric pressure at sea level is ..... (units).
QUJ	Will you indicate the true course for me to follow, with no wind, to make for you?	The true course for you to follow, with no wind, to make for me is ..... degrees at ..... (time).

**Special abbreviations adopted by the A.R.R.L.:**

QST General call preceding a message addressed to all amateurs and A.R.R.L. Members. This is in effect "CQ ARRL."  
 QRR Official A.R.R.L. "land SOS." A distress call for use by stations in emergency zones only.

# The Radio Amateur's Handbook . . . . .

## Miscellaneous Abbreviations

Abbreviation	Meaning
C	Yes.
N	No.
P	Indicator of private telegram in the mobile service (to be used as a prefix).
W	Word or words.
AA	All after . . . . . (to be used after a note of interrogation to ask for a repetition).
AB	All before . . . . . (to be used after a note of interrogation to ask for a repetition).
AL	All that has just been sent (to be used after a note of interrogation to ask for a repetition).
BN	All between . . . . . (to be used after a note of interrogation to ask for a repetition).
BQ	A reply to an RQ.
CL	I am closing my station.
CS	Call sign (to be used to ask for a call sign or to have one repeated).
DB	I cannot give you a bearing, you are not in the calibrated sector of this station.
DC	The minimum of your signal is suitable for the bearing.
DF	Your bearing at . . . . . (time) was . . . . . degrees, in the doubtful sector of this station, with a possible error of two degrees.
DG	Please advise me if you note an error in the bearing given.
DI	Bearing doubtful in consequence of the bad quality of your signal.
DJ	Bearing doubtful because of interference.
DL	Your bearing at . . . . . (time) was . . . . . degrees, in the doubtful sector of this station.
DO	Bearing doubtful. Ask for another bearing later, or at . . . . . (time).
DP	Beyond 50 miles, the possible error of bearing may amount to two degrees.
DS	Adjust your transmitter, the minimum of your signal is too broad.
DT	I cannot furnish you with a bearing; the minimum of your signal is too broad.
DY	This station is two-way, what is your approximate direction in degrees in relation to this station?
DZ	Your bearing is reciprocal (to be used only by the control station of a group of direction-finding stations when it is addressing other stations of the same group).
ER	Here . . . . . (to be used before the name of the mobile station in the sending of route indications).
GA	Resume sending (to be used more specially in the fixed service).
JM	If I may transmit, send a series of dashes. To stop my transmission, send a series of dots [not to be used on 500 kc/s (600 m)].
MN	Minute or minutes (to be used to indicate the duration of a wait).
NW	I resume transmission (to be used more especially in the fixed service).
OK	Agreed.
RQ	Designation of a request.
SA	Indicator preceding the name of an aircraft station (to be used in the sending of particulars of flight).
SF	Indicator preceding the name of an aeronautical station.
SN	Indicator preceding the name of a coast station.
SS	Indicator preceding the name of a ship station (to be used in sending particulars of voyage).
TR	Indicator used in sending particulars concerning a mobile station.
UA	Are we agreed?
WA	Word after . . . . . (to be used after a note of interrogation to request a repetition).
WB	Word before . . . . . (to be used after a note of interrogation to request a repetition).
XS	Atmospherics.



Abbreviation	Meaning
YS	Your service message.
ABV	Repeat (or I repeat) the figures in abbreviated form.
ADR	Address (to be used after a note of interrogation to request a repetition).
CFM	Confirm (or I confirm).
COL	Collate (or I collate).
ITP	Stops (punctuation) count.
MSG	Telegram concerning the service of the ship (to be used as a prefix.)
NIL	I have nothing for you (to be used after an abbreviation of the Q code to mean that the answer to the question put is negative).
PBL	Preamble (to be used after a note of interrogation to request a repetition).
REF	Referring to . . . . . (or Refer to . . . . .).
RPT	Repeat (or I repeat) (to be used to ask for or to give repetition of all or part of the traffic, the relative particulars being sent after the abbreviation).
SIG	Signature (to be used after a note of interrogation to request a repetition).
SVC	Indicator of service telegram concerning private traffic (to be used as a prefix).
TFC	Traffic.
TXT	Text (to be used after a note of interrogation to request a repetition).

### International Prefixes

● The nationality of a radio station is shown by the initial letter or letters of its call signal. The International Telecommunications Convention, supplemented by provisional action of the Berne Bureau, allocates the alphabet amongst the nations of the world for that purpose. Every station call of a nation must be taken from the block of letters thus assigned it. The amateur station call commonly consists of one or two initial letters thus chosen (to indicate nationality), a digit (assigned by the local government to indicate the subdivision of the nation in which the station is located), and two or three additional letters (to identify the individual station).

In the list which follows the first column shows the international allocation of blocks of call signals. This list is useful in identifying the nationality of any call heard, whether amateur or not. In the second column appears the area to which the calls are assigned. In the third column the amateur prefixes, the beginning letters of amateur calls, are listed. Where a prefix is shown in brackets, it indicates that that government has more than one assignment of initial letters and that the indicated letter will be found assigned, in another part of the list, to that country. The list:

<i>Block Assigned to</i>	<i>Amateur Prefix</i>
CAA-CEZ . . . . . Chile . . . . .	. . . . . CE
CFA-CKZ . . . . . Canada . . . . .	[VE]
CLA-CMZ . . . . . Cuba . . . . .	CM [CO]
CNA-CNZ . . . . . Morocco . . . . .	CN
COA-COZ . . . . . Cuba . . . . .	CO [CM]
CPA-CPZ . . . . . Bolivia . . . . .	CP
CQA-CRZ . . . . . Portuguese Colonies: Cape Verde Islands . . . . .	. . . . . CR4

Portuguese Guinea . . . . .	CR5
Angola . . . . .	CR6
Mozambique . . . . .	CR7
Portuguese India . . . . .	CR8
Macao . . . . .	CR9
Timor . . . . .	CR10
CSA-CUZ . . . . . Portugal:	
Portugal proper . . . . .	CT1
Azores Islands . . . . .	CT2
Madeira Islands . . . . .	CT3
CVA-CXZ . . . . . Uruguay . . . . .	CX
CYA-CZZ . . . . . Canada . . . . .	[VE]
D . . . . . Germany . . . . .	D
EAA-EHZ . . . . . Spain:	
Spain proper . . . . .	EA1-2-3-4-5-7
Balearic Islands . . . . .	EA6
Canary Islands . . . . .	EA8
Spanish Morocco and North Africa . . . . .	EA9
EIA-EIZ . . . . . Irish Free State . . . . .	EI
ELA-ELZ . . . . . Liberia . . . . .	EL
EPA-EQZ . . . . . Iran (Persia) . . . . .	EP
ESA-ESZ . . . . . Estonia . . . . .	ES
ETA-ETZ . . . . . Ethiopia (Abyssinia) . . . . .	ET
F . . . . . France:	
France proper . . . . .	F3, F8
Algeria . . . . .	FA
Madagascar . . . . .	FB8
French Togoland . . . . .	FD8
French Cameroons . . . . .	FES
French West Africa . . . . .	FF8
Guadeloupe . . . . .	FG8
French Indo-China . . . . .	F18
New Caledonia . . . . .	FK8
French Somaliland . . . . .	FL8
Martinique . . . . .	FMS
French India . . . . .	FNS
French Oceania . . . . .	FOS
Miquelon & St. Pierre Islands . . . . .	FPS
French Equatorial Africa . . . . .	FQ8
Reunion Island . . . . .	FR8
Tunisia . . . . .	FT4
New Hebrides (French) . . . . .	FU8
French Guiana and Inini . . . . .	FY8
G . . . . . United Kingdom:	
Great Britain except Ireland . . . . .	G
Northern Ireland . . . . .	GI
HAA-HAZ . . . . . Hungary . . . . .	HAF

# The Radio Amateur's Handbook . . . . .

HBA-HBZ	Swiss Confederation	HB
HCA-HCZ	Ecuador	HC
HHA-HHZ	Republic of Haiti	HH
HIA-HIZ	Dominican Republic	HI
HJA-HKZ	Republic of Colombia	HJ-HK
HPA-HPZ	Republic of Panama	HP
HRA-HRZ	Republic of Honduras	HR
HSA-HSZ	Siam	HS
HVA-HVZ	Vatican City	
HZA-HZZ	Hedjaz	HZ
I	Italy and Colonies	I
J	Japanese Empire:	
	Japan	J1-J7
	Chosen (Korea)	J8
	Taiwan (Formosa)	J9
K	United States of America:	
	Continental United States	[W] (N) <sup>2</sup>
	Puerto Rico and Virgin Islands	K4
	Canal Zone	K6
	Territory of Hawaii, Guam, U. S. Samoa, and Midway & Wake Ids.	K6
	Alaska	K7
	Philippine Islands	K8
LAA-LNZ	Norway	LA
LOA-LWZ	Argentine Republic	LU
LXA-LXZ	Luxemburg	LX
LYA-LYZ	Lithuania	LY
LZA-LZZ	Bulgaria	LZ
M	Great Britain	M
N	United States of America	[K-W] (N) <sup>2</sup>
OAA-OCZ	Peru	OA
OEA-OEZ	Austria	OE
OFA-OHZ	Finland	OH
OKA-OKZ	Czechoslovakia	OK
ONA-OTZ	Belgium and Colonies	ON
OUA-OZZ	Denmark:	
	Denmark	OZ
	Faeroes	OY
	Greenland	OX
PAA-PIZ	Netherlands	PA
PIA-PJZ	Curacao	PJ
PKA-POZ	Netherlands Indies:	
	Java	PK1-2-3
	Sumatra	PK4
	Dutch Borneo	PK5
	Celebes, Moluccas and New Guinea	PK6
PPA-PYZ	Brazil	PY
PZA-PZZ	Surinam	PZ
R	Union of Socialist Soviet Republics	[U]
SAA-SMZ	Sweden	SM
SOA-SRZ	Poland	SP
STA-SUZ	Egypt:	
	Sudan	ST
	Egypt	SU
SVA-SZZ	Greece	SV
TAA-TCZ	Turkey	TA
TFA-TFZ	Iceland	TF
TGA-TGZ	Guatemala	TG
TIA-TIZ	Costa Rica	TI
TKA-TZZ	France and Colonies and Protectorates [F]	
U	Union of Socialist Soviet Republics:	
	European Soviet Republics (Russia)	U1-2-3-4-5-6
	Asiatic Soviet Republics (Siberia)	U8-9-0
VAA-VGZ	Canada	VE
VHA-VMZ	Commonwealth of Australia:	
	Australia	VK-2-3-4-5-6-8
	Tasmania	VK7
	New Guinea	VK9
VOA-VOZ	Newfoundland	VO
VPA-VSZ	British Colonies and Protectorates:	
	British Honduras and Zanzibar	VP1
	Leeward Ids. and Antigua	VP2
	Gilbert & Ellice Islands and Ocean Id.	VR1

British Guiana	VP3	
Trinidad and Tobago	VP4	
Jamaica and Cayman Islands	VP5	
Barbados	VP6	
Bahamas	VP7	
Falkland Ids.	VP8	
Bermuda	VP9	
Fanning Island	VQ1	
Northern Rhodesia	VQ2	
Tanganyika	VQ3	
Kenya	VQ4	
Uganda	VQ5	
Mauritius and St. Helena	VQ8	
Fiji Islands	VR-2	
Solomon Islands	VR4	
Straits Settlements	VS1	
Malaya	VS2-VS3	
North Borneo	VS4	
Sarawak	VS5	
Hong Kong	VS6	
Ceylon	VS7	
Bahrein Id.	VSS	
Maldiva Ids.	VS9	
VTA-VWZ	British India	VU
VXA-VYZ	Canada	[VE]
W	United States of America	[K] (N) <sup>2</sup> W
XAA-XFZ	Mexico	XE
XGA-XUZ	China	XT-XU
XYA-XZZ	British India	[VU]
YAA-YAZ	Afghanistan	YA
YBA-YHZ	Netherlands Indies	[PK]
YIA-YIZ	Iraq	YI
YJA-YJZ	New Hebrides	YJ
YLA-YLZ	Latvia	YL
YMA-YMZ	Free City of Danzig	YM
YNA-YNZ	Nicaragua	YN
YOA-YRZ	Roumania	YR
YSA-YSZ	Republic of El Salvador	YS
YTA-YUZ	Yugo-Slavia	YT-YU
YVA-YWZ	Venezuela	YV
ZAA-ZAZ	Albania	ZA
ZBA-ZJZ	British Colonies and Protectorates:	
	Malta	ZB1
	Gibraltar	ZB2
	Transjordanian	ZC1
	Cocos Islands	ZC2
	Christmas Island	ZC3
	Cyprus	ZC4
	Palestine	ZC6
	Sierra Leone	ZD1
	Nigeria and British Cameroons	ZD2
	Gambia	ZD3
	Gold Coast	ZD4
	Nyasasa	ZD6
	Ascencion	ZD8
	Southern Rhodesia	ZE
ZKA-ZMZ	New Zealand:	
	Cook Islands	ZK1
	Niue	ZK2
	New Zealand	ZL
	British Samoa	ZM
ZPA-ZPZ	Paraguay	ZP
ZSA-ZUZ	Union of South Africa	ZS-ZT-ZU
ZVA-ZZZ	Brazil	[PY]

<sup>1</sup> CM is used by c.w. stations; CO by 'phones.

There are, in addition, certain prefixes not officially assigned which are at present used by amateurs of several countries. Some of these are:

AC4	Tibet
AR	Syria
NY	Canal Zone
OM	Guam
PX	Andorra

<sup>2</sup> Certain amateur stations licensed to members of the U. S. Naval Communications Reserve are authorized to use the prefix N.

## DX Time Chart

● When one works DX with his amateur station, the world is the limit. A large number of the stations worked will be in a different time zone. Time-around the world is determined by geographical meridians, an hour to each 15 degrees of longitude. A convenient chart for time conversion between your station and that of stations worked in other countries has been prepared by Don Mix of W1TS. In the table, under West Longitude, 75th, 90th, 105th and 120th meridian time refers to Eastern, Central, Mountain, and Pacific standard time respectively. Following the chart is a list giving the "prefixes" of approximately 200 different countries where radio amateurs are active on the air, and the time meridian of each such country, so its time may be converted to your own direct from the table.

### DIRECTIONS FOR USING DX TIME CHART

**CASE 1.** — To find time at distant station corresponding to any selected local time

Pick out local time meridian on horizontal scale.

Follow column down to time meridian of distant station on vertical scale. Add or subtract number of hours indicated to or from local standard clock reading.

*Example:* My station is running on 75th west meridian time (E.S.T.).

When it is 9 a.m. here, what time is it in Japan?

From list of foreign countries, Japan is on 135th east meridian time. Follow column for 75th west down to 135th east on vertical scale. The table shows that 14 hours should be added to local clock reading. Therefore it is 11 p.m. of the same day.

**CASE 2.** — To find local time corresponding to any selected foreign time.

Pick out foreign time meridian on horizontal scale.

Follow column down to local time meridian on vertical scale. Add or subtract number of hours indicated to or from foreign clock reading.

*Example:* My station is running on 90th west meridian time (C.S.T.).

When it is 10 p.m. in Madagascar, what time is it here?

From list of foreign countries, Madagascar is on 45th east meridian time. Follow column for 45th east down to 90th west on vertical scale. The table shows that 9 hours should be subtracted. Therefore, when it is 10 p.m. in Madagascar, it is 1 p.m. C.S.T.

AC4	Tibet	90E
AR	Syria	30-45E
CE	Chile	60W
CM	Cuba	75W
CN	Morocco	0
CO	Cuba (fone)	75W
CP	Bolivia	63W plus 33 mins.
CR4	Cape Verde Islands	30W
CR5	Portuguese Guinea	15W
CR6	Angola	15E
CR7	Mozambique	30E
CR8	Portuguese India	75E plus ½ hour
CR9	Macao	120E
CR10	Timor	120E
CT1	Portugal	0
CT2	Azores	30W
CT3	Madeira Island	15W
CX	Uruguay	60W plus ½ hour
D	Germany	15E
EA	Spain	0
EA6	Balearic Islands	0

EA8	Canary Islands	15W
EA9	Spanish Morocco	0
EI	Irish Free State	0
EL	Liberia	15W plus 16 mins.
EP	Iran (Persia)	60E-45E
EQ	Iran (Persia)	60E-45E
ES	Estonia	30E
ET	Ethiopia (Abyssinia)	30E-40E
F	France	0
FA	Algeria	0
FB	Madagascar	45E
FD	French Togoland	0
FE	French Cameroons	0 plus 39 mins.
FF	French West Africa	0
FG	Guadeloupe	60W
FI	French Indo China	90E plus ½ hour
FK	New Caledonia	165E
FL	French Somaliland	45E
FM	Martinique	60W
FN	French India	0
FO	French Oceania	0
FP	St. Pierre and Miquelon	60W
FQ	French Equatorial Africa	15E
FR	Reunion Island	60E
FT	Tunisia	15E
FU	French New Hebrides	165E
FY	Guyane (French Guiana)	60W
G	England	0
G	Scotland	0
GI	North Ireland	0
HAF	Hungary	15E
HB	Switzerland	15E
HC	Ecuador	60W
HH	Haiti	75W
HI	Dominican Republic	75W plus 20 mins.
HJ	Colombia	75W
HK	Colombia	75W
HP	Republic of Panama	75W
HR	Honduras	90W
HS	Siam	105E
HZ	Hedjaz	30E
I	Italy	15E
J	Japan	135E
J8	Chosen (Korea)	135E
J9	Formosa	120E
K4	Porto Rico	60W
K4	Virgin Islands	60W
K5	Canal Zone	75W
K6	Hawaii	150W (minus ½ hour)
K6	Guam	150E
K6	Samoa	180
K6	Midway and Wake Is.	165E-180
K7	Alaska	135W-150W-165W
KA	Philippines	120E
LA	Norway	15E
LU	Argentina	60W
LX	Luxemburg	15E
LY	Lithuania	30E
LZ	Bulgaria	30E
MX	Manchukuo	120E
NY	Canal Zone	75W
OA	Peru	75W
OE	Austria	75E
OH	Finland	30E
OK	Czechoslovakia	15E
OM	Guam	150E
ON	Belgium	0
ON4	Belgian Congo	15E
OX	Greenland	75W-15W
OY	Faroe Islands	0
OZ	Denmark	15E
PA	Netherlands	15E
PJ	Curacao	60W
PK1, 2, 3	Java	105E plus 20 mins.
PK4	Sumatra	90E plus ½ hour
PK5	Dutch Borneo	105E plus ½ hour
PK6	Celebes-New Guinea	135E-120E
PX	Andorra	0

# The Radio Amateur's Handbook . . . . .

## LOCAL MERIDIAN

		West Longitude										East Longitude														
		0	15	30	45	60	75	90	105	120	135	150	165	180	165	150	135	120	105	90	75	60	45	30	15	
West Longitude	0	0	+1	+2	+3	+4	+5	+6	+7	+8	+9	+10	+11	-12	-11	-10	-9	-8	-7	-6	-5	-4	-3	-2	-1	
	15	-1	0	+1	+2	+3	+4	+5	+6	+7	+8	+9	+10	-13	-12	-11	-10	-9	-8	-7	-6	-5	-4	-3	-2	
	30	-2	-1	0	+1	+2	+3	+4	+5	+6	+7	+8	+9	-14	-13	-12	-11	-10	-9	-8	-7	-6	-5	-4	-3	
	45	-3	-2	-1	0	+1	+2	+3	+4	+5	+6	+7	+8	-15	-14	-13	-12	-11	-10	-9	-8	-7	-6	-5	-4	
	60	-4	-3	-2	-1	0	+1	+2	+3	+4	+5	+6	+7	-16	-15	-14	-13	-12	-11	-10	-9	-8	-7	-6	-5	
	75	-5	-4	-3	-2	-1	0	+1	+2	+3	+4	+5	+6	-17	-16	-15	-14	-13	-12	-11	-10	-9	-8	-7	-6	
	90	-6	-5	-4	-3	-2	-1	0	+1	+2	+3	+4	+5	-18	-17	-16	-15	-14	-13	-12	-11	-10	-9	-8	-7	
	105	-7	-6	-5	-4	-3	-2	-1	0	+1	+2	+3	+4	-19	-18	-17	-16	-15	-14	-13	-12	-11	-10	-9	-8	
	120	-8	-7	-6	-5	-4	-3	-2	-1	0	+1	+2	+3	-20	-19	-18	-17	-16	-15	-14	-13	-12	-11	-10	-9	
	135	-9	-8	-7	-6	-5	-4	-3	-2	-1	0	+1	+2	-21	-20	-19	-18	-17	-16	-15	-14	-13	-12	-11	-10	
	150	-10	-9	-8	-7	-6	-5	-4	-3	-2	-1	0	+1	-22	-21	-20	-19	-18	-17	-16	-15	-14	-13	-12	-11	
	165	-11	-10	-9	-8	-7	-6	-5	-4	-3	-2	-1	0	-23	-22	-21	-20	-19	-18	-17	-16	-15	-14	-13	-12	
	180	+12	+13	+14	+15	+16	+17	+18	+19	+20	+21	+22	+23	0	+1	+2	+3	+4	+5	+6	+7	+8	+9	+10	+11	
	East Longitude	165	+11	+12	+13	+14	+15	+16	+17	+18	+19	+20	+21	+22	-1	0	+1	+2	+3	+4	+5	+6	+7	+8	+9	+10
		150	+10	+11	+12	+13	+14	+15	+16	+17	+18	+19	+20	+21	-2	-1	0	+1	+2	+3	+4	+5	+6	+7	+8	+9
135		+9	+10	+11	+12	+13	+14	+15	+16	+17	+18	+19	+20	-3	-2	-1	0	+1	+2	+3	+4	+5	+6	+7	+8	
120		+8	+9	+10	+11	+12	+13	+14	+15	+16	+17	+18	+19	-4	-3	-2	-1	0	+1	+2	+3	+4	+5	+6	+7	
105		+7	+8	+9	+10	+11	+12	+13	+14	+15	+16	+17	+18	-5	-4	-3	-2	-1	0	+1	+2	+3	+4	+5	+6	
90		+6	+7	+8	+9	+10	+11	+12	+13	+14	+15	+16	+17	-6	-5	-4	-3	-2	-1	0	+1	+2	+3	+4	+5	
75		+5	+6	+7	+8	+9	+10	+11	+12	+13	+14	+15	+16	-7	-6	-5	-4	-3	-2	-1	0	+1	+2	+3	+4	
60		+4	+5	+6	+7	+8	+9	+10	+11	+12	+13	+14	+15	-8	-7	-6	-5	-4	-3	-2	-1	0	+1	+2	+3	
45		+3	+4	+5	+6	+7	+8	+9	+10	+11	+12	+13	+14	-9	-8	-7	-6	-5	-4	-3	-2	-1	0	+1	+2	
30		+2	+3	+4	+5	+6	+7	+8	+9	+10	+11	+12	+13	-10	-9	-8	-7	-6	-5	-4	-3	-2	-1	0	+1	
15		+1	+2	+3	+4	+5	+6	+7	+8	+9	+10	+11	+12	-11	-10	-9	-8	-7	-6	-5	-4	-3	-2	-1	0	

- |                 |                            |                      |          |  |                     |
|-----------------|----------------------------|----------------------|----------|--|---------------------|
| PY.....         | Brazil.....                | 45W-60W              | VK5..... | Australia.....                             | 135E (minus ½ hour) |
| PZ.....         | Surinam (Dutch Guiana)     | 60W plus 19 mins.    | VK6..... | Australia.....                             | 120E                |
| Sm.....         | Sweden.....                | 15E                  | VK7..... | Tasmania.....                              | 150E                |
| SP.....         | Poland.....                | 15E                  | VK8..... | Australia.....                             | 135E (minus ½ hour) |
| ST.....         | Sudan.....                 | 30E                  | VK9..... | New Guinea.....                            | 150E                |
| SU.....         | Egypt.....                 | 30E                  | VO.....  | Newfoundland, Labrador                     | 60W plus 29 mins.   |
| SV.....         | Greece.....                | 30E                  | VP1..... | British Honduras.....                      | 90W                 |
| SX.....         | Greece.....                | 30E                  | VP2..... | Antigua, St. Kitts, Nevis, Ocean I.....    | 60W                 |
| TA.....         | Turkey.....                | 30E                  | VP3..... | British Guiana.....                        | 60W                 |
| TF.....         | Iceland.....               | 15W                  | VP4..... | Trinidad, Tobago.....                      | 60W                 |
| TG.....         | Guatemala.....             | 90W                  | VP5..... | Jamaica, Caicos, Cayman Is., Turks Is..... | 60W-75W             |
| TI.....         | Costa Rica.....            | 90W                  | VP6..... | Barbados.....                              | 60W                 |
| U.....          | Russia (USSR).....         | 60E-30E              | VP7..... | Bahamas.....                               | 75W                 |
| UE.....         | Russia (USSR).....         | 60E-30E              | VP8..... | Falkland Is., South Georgia.....           | 60W-30W             |
| UK.....         | Russia (USSR).....         | 60E-30E              | VP9..... | Bermuda.....                               | 60W minus 19 mins.  |
| UX.....         | Russia (USSR).....         | 60E-30E              | VQ1..... | Fanning Island.....                        | 165W                |
| U-0, 8, 9.....  | Siberia (USSR).....        | 60E to 180           | VQ2..... | Northern Rhodesia.....                     | 30E                 |
| UE-0, 8, 9..... | Siberia (USSR).....        | 60E to 180           | VQ3..... | Tanganyika.....                            | 45E                 |
| UK-0, 8, 9..... | Siberia (USSR).....        | 60E to 180           | VQ4..... | Kenya.....                                 | 30E plus ½ hour     |
| UX-0, 8, 9..... | Siberia (USSR).....        | 60E to 180           | VQ5..... | Uganda.....                                | 30E                 |
| VE1.....        | Canada.....                | 60W                  | VQ6..... | British Somaliland.....                    | 45E                 |
| VE2.....        | Canada.....                | 75W (EST)            | VQ8..... | Mauritius.....                             | 60E                 |
| VE3.....        | Canada.....                | 75W (EST)-90W (CST)  | VQ9..... | Seychelles.....                            | 60E                 |
| VE4.....        | Canada.....                | 90W (CST)-105W (MST) | VR1..... | Gilbert and Ellice Islands.....            | 180                 |
| VE5.....        | Canada.....                | 120W (PST)           | VR2..... | Fiji Islands.....                          | 180                 |
| VE6.....        | Northwest Territories..... | 120W to 60W          | VR4..... | Solomon Islands.....                       | 150E                |
| VK2.....        | Australia.....             | 150E                 | VR5..... | Tonga Islands.....                         | 180                 |
| VK3.....        | Australia.....             | 150E                 | VR6..... | Pitcairn Island.....                       | 135W                |
| VK4.....        | Australia.....             | 150E                 |          |  |                     |

# Great Circle Distance Chart

**T**HIS TABLE shows the great circle distances between principal points on the face of the globe. To approximate the radio distances between other points it is necessary to add or subtract a correction to the distance as obtained from the table.

In applying these corrections it must be remembered that the great circle distances between points will not necessarily be straight lines on the map. As they lie on the surface of the globe if plotted on the map they become curves. The Chicago-Tokio distance line, for example, curves upward through the center of Alaska.

These peculiarities of great circle distances must be taken into consideration in making corrections to the table.

Care must be taken in estimating distances to use the proper scales applicable at the locations.

For example, to determine the radio distance from Madison, Wisconsin, U. S. A., to Shanghai, China —

The nearest points listed are Chicago, U. S. A., and Tokio, Japan. By using the radio distance table it is found that the distance between Chicago and Tokio is 6200 miles. Madison is about 120 miles north of Chicago in a direction which will not decrease the total distance from Chicago to Shanghai. Shanghai is found to be about 800 miles west and 400 miles south of Tokio. The correction movement north at Chicago will tend to shorten the total distance, but as there is a southerly correction at Tokio, these will probably balance.

The total estimated radio distance then becomes —

Chicago to Tokio — from table . . . . . 6200 miles

Chicago to Madison — no correction.

Tokio to Shanghai — farther about . . . . . 800 miles

Madison to Shanghai 7000 miles

Courtesy Burgess Battery Company

Appendix

# The Radio Amateur's Handbook . . . . .

VS1.....	Straits Settlements	105E plus ½ hour
VS2.....	Federated Malay States	105E plus ½ hour
VS3.....	Non-Federated Malay States	105E plus ½ hour
VS4.....	North Borneo	120E
VS5.....	Sarawak	105E
VS6.....	Hongkong	120E
VS7.....	Ceylon	75E plus ½ hour
V88.....	Bahrein Islands	75E-90E
VS9.....	Maldive Islands	75E
VU.....	India	75E-90E
W1.....	U. S. A.	75W (EST)
W2.....	U. S. A.	75W (EST)
W3.....	U. S. A.	75W (EST)
W4.....	U. S. A.	75W (EST)-90W (CST)
W5.....	U. S. A.	90W (CST)-105W (MST)
W6.....	U. S. A.	105W (MST)-120W (PST)
W7.....	U. S. A.	105W (MST)-120W (PST)
W8.....	U. S. A.	75W (EST)-90W (CST)
W9.....	U. S. A.	75 W (EST)-90W (CST)-105W (MST)
XE.....	Mexico	105W (MST)
XU.....	China	150E-135E-120E-105E-90E-75E
YA.....	Afghanistan	60E
YI.....	Iraq	45E
YJ.....	New Hebrides	165E
YL.....	Latvia	30E
YM.....	Danzig	15E
YN.....	Nicaragua	90W
YR.....	Roumania	30E
YS.....	Salvador	90W
YT.....	Jugoslavia	15E
YU.....	Jugoslavia	15E
YV.....	Venezuela	75 plus ½ hour
ZA.....	Albania	15E
ZB1.....	Malta	15E
ZB2.....	Gibraltar	0
ZC1.....	Transjordania	30E
ZC2.....	British Cocos Islands	90E
ZC3.....	Christmas I.	150W
ZC4.....	Cyprus	30E
ZC5.....	Palestine	30E
ZD1.....	Sierra Leone	15W
ZD2.....	Nigeria, British Cameroons	0
ZD3.....	Gambia	15W
ZD4.....	Gold Coast, British Togoland	0
ZD6.....	Nyasaland	30E
ZD7.....	St. Helena	15W plus 37 mins.
ZD8.....	Ascension Island	15W
ZE.....	Southern Rhodesia	30E
ZK1.....	Cook Islands	165W
ZK2.....	Niue	165E
ZL.....	New Zealand	180 (minus ½ hour)
ZM.....	British Samoa	180
ZP.....	Paraguay	60W
ZS.....	Union of South Africa	30E
ZT.....	Union of South Africa	30E
ZU.....	Union of South Africa	30E
ZU9.....	Tristan da Cunha	15W

## DX Tables

● We are indebted to Charlie Perrine, W6CUH, and to Don H. Mix, W1TS, for the suggestions for proper times to look for different countries. We hope our tables will prove helpful to the new DX man, and the old timer alike, since it has been brought up to date just as we go to press. These tables have been prepared looking to our annual 1937 DX tests. Of course the daily differences, seasonal fluctuations, and the long term changes in conditions which correspond closely to the sunspot cycle cannot be taken into account and absolute reliance should

not be placed in tables for such. Tables are extremely helpful and useful for reference, to give all concerned an idea as to the most effective time to look for DX. For additional information, consult DX notes and seasonal tables which will appear in *QST* from time to time.

Two separate tables have been prepared, one for the average experience of amateurs on the west coast of North America, and another for the east coast of North America. Time in both tables is Greenwich, and should be converted to your own local time with reference of course to proper conversion for 120th meridian or 75th meridian respectively. Only two tables are presented since it is believed that DX conditions obtaining in the central part of the country correspond closely to the mean between conditions represented by the tables for the extreme east or west.

The tables give "best" times only. On monthly DX peaks, a considerable extension of the periods for working different countries may be expected. For example, on the west coast, on 14 mc. European stations may be good from 1330 to 0200 GMT (almost all day long) when conditions are at their best, instead of from 1400 to 1700, the "best" time shown in the table.

## DX TIME TABLES FOR THE NORTH AMERICAN CONTINENT

("Best Times" Fall and Winter 1936-1937)

FOR WESTERN STATIONS

14 Mc. 7 Mc.

### EUROPE:

EA, CT1, CT3..... 0000-0200 0200-0500

F, G, ON, PA, OZ, SM, LA,

EL, GI, HB, D, TF... 1400-1700 0300-0700

& 2000-2200

OK, U, YL, OE, LY, OH,

SX..... 1400-1600 0600-1000

### AFRICA:

ZT, ZS, ZU..... 1400-1700 0400-0600

& 1430-1700

VQ4, ON4, ZD, ZE..... 2000-2130 0400-0600

FM, FA, FT..... 0100-0200 1430-1600

ZE, CR7, FB.....

### SOUTH AMERICA:

ALL..... 2300-0100 0200-0900

& 1400-1500

LU, CX, CE, OA, HC... 1400-1600

& 2000-2100

### ASIA:

XU, VU, VS1, VS6, J... 1400-1700 1300-1500

VS2, 3, 5, 7..... 1300-1500

U, J..... 0300-0400 1300-1700

& 0700-0900

### OCEANIA:

VK, FK, VR4..... 1300-1500 0500-1500

& 0300-0500

ZL..... 0300-0500 0500-1500

PK1, 2, 3, 4, 5, 6, VR 2, OM,

KA..... 0100-1100

### NORTH AMERICA:

Central..... 2000-0300 0200-1500

Caribbean..... 1600-1800 0200-1500

& 2200-0100

Alaska..... 0000-0200 0100-1600

# Appendix

## FOR EASTERN STATIONS

	14 Mc.	7 Mc.
<b>EUROPE:</b>		
(Western) CT1-2-3, D, EA, EI, F, G, GI, HB, ON, PA, TF, YM, ZB . . . . .	1100-1300 & 1900-2300	2400-0400
(Eastern) ES, HAF, I, LA, LY, OE, OH, OK, OZ, SM, SP, SV, SX, U, YL, YT, YU, YR . . . . .	1000-1200 & 2000-2400	0100-0500
<b>AFRICA:</b>		
(North) CN, EAS, EA, FA, FT, SU . . . . .	1100-1300 1900-2300	2400-0400
(Central and South) CR7, FBS, ON4, VQ2, 3, 4, 5, 8, ZD, ZE, ZS, ZT, ZU . . . . .	1100-1300 1800-2000 (also around 0400)	
<b>SOUTH AMERICA:</b>		
CE, CP, CX, HC, HJ, OA, PY, YV, ZP . . . . .	1100-1200 2100-0100	2100-0700
<b>ASIA:</b>		
(Eastern) XU, J, MX, VS6	1100-1400	
(Western) AR, YI, ZC . . . . .	2000-2300	
<b>OCEANIA:</b>		
FK, K6, KA, OM, PK, VK, VR4, VS1, 2, 3, 5, 7, 8, ZL . . . . .	1100-1300	0500-1200
<b>NORTH AMERICA:</b>		
CM, FM —, HH, HI, HP, HR, K4, 5, NY, TG, TI, VP1, VP2, 4, 5, 6, 7, 9, YN, YS . . . . .	1000-1300 2100-0200	2100-0900

## The Decibel

● The decibel (abbreviated *db*) is a convenient unit for the measurement of electrical or acoustic power ratios on a logarithmic scale. The number of decibels equivalent to the ratio between two amounts of power is

$$db = 10 \log_{10} \frac{P_1}{P_2}$$

Since the decibel is a logarithmic unit, successive gains and losses expressed in *db* can be added algebraically. If the ratio of the two power values is greater than 1 there is a power gain; if the ratio is less than 1 there is a loss of power. A gain is expressed in "plus *db*"; a loss in "minus *db*."

The decibel also can be used to express ratios between voltages and currents provided the circuit conditions are the same for the two quantities whose magnitudes are being compared; i.e., if the impedances and power factors of the circuits are the same.

The decibel is primarily a unit which specifies gains or losses with reference to the power value at some point in a system regardless of the actual value of the reference power. In

telephone and radio work, however, it is convenient to assume a reference power level and express the power at a point in a circuit in terms of "plus *db*" or "minus *db*" above or below this reference level. A standard reference level in radio work is .006 watts, or 6 milliwatts.

## Standard Letter Symbols for Electrical Quantities

Admittance	<i>Y, y</i>
Angular velocity ( $2\pi f$ )	$\omega$
Capacitance	<i>C</i>
Conductance	<i>G, g</i>
Current	<i>I, i</i>
Difference of potential	<i>E, e</i>
Dielectric constant	<i>K</i> or $\epsilon$
Energy	<i>W</i>
Frequency	<i>f</i>
Impedance	<i>Z, z</i>
Inductance	<i>L</i>
Magnetic intensity	<i>H</i>
Magnetic flux	$\Phi$
Magnetic flux density	<i>B</i>
Mutual inductance	<i>M</i>
Number of conductors or turns	<i>N</i>
Permeability	$\mu$
Phase displacement	$\theta$ or $\Phi$
Power	<i>P, p</i>
Quantity of electricity	<i>Q, q</i>
Reactance	<i>X, x</i>
Resistance	<i>R, r</i>
Susceptance	<i>b</i>
Speed of rotation	<i>n</i>
Voltage	<i>E, e</i>
Work	<i>W</i>

## Letter Symbols for Vacuum Tube Notation

Grid potential	$E_g, e_g$
Grid current	$I_g, i_g$
Grid conductance	$g_g$
Grid resistance	$r_g$
Grid bias voltage	$E_c$
Plate potential	$E_p, e_p$
Plate current	$I_p, i_p$
Plate conductance	$g_p$
Plate resistance	$r_p$
Plate supply voltage	$E_b$
Emission current	$I_s$
Mutual conductance	$g_m$
Amplification factor	$\mu$
Filament terminal voltage	$E_f$
Filament current	$I_f$
Filament supply voltage	$E_a$
Grid-plate capacity	$C_{gp}$
Grid-filament capacity	$C_{gf}$
Plate-filament capacity	$C_{pf}$
Grid capacity ( $C_{gp} + C_{gf}$ )	$C_p$
Plate capacity ( $C_{gp} + C_{pf}$ )	$C_o$
Filament capacity ( $C_{gf} + C_{pf}$ )	$C_f$

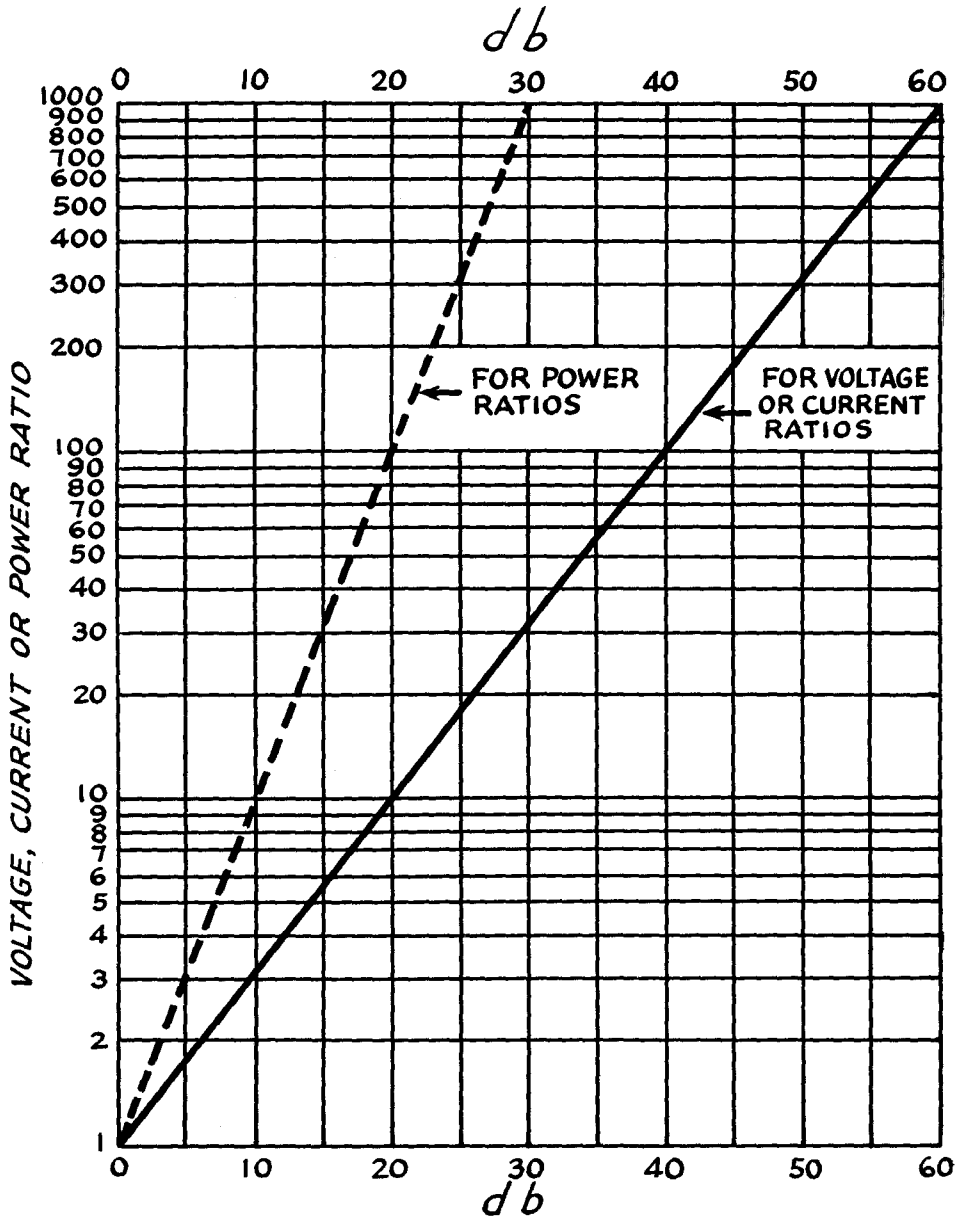

DECIBEL CHART FOR POWER, VOLTAGE OR CURRENT CALCULATIONS

To find db gain, divide output power, voltage or current by corresponding input value and read db value for this ratio. To find db loss, as where output is less than input, divide input value by output value. Power, voltage or current values must be in same units (watts, millivolts, microamperes, etc.). The chart also can be used for ratios greater than 1000. For power ratios between 1000 and 10,000, divide given ratio by 10 and add 10 db to value read from the chart. For voltage and current ratios between 1000 and 10,000, divide given ratio by 10 and add 20 db to value read from the chart. For example, to find db gain for a power ratio of 8000, read db value for power ratio of 800 (29 db) and add 10 db, the answer being 39 db; or to find db gain for a voltage ratio of 8000, read db value for voltage ratio of 800 (58 db) and add 20 db, the answer being 78 db.



# Appendix

NOTE.—Small letters refer to instantaneous values.

## Metric Prefixes Often Used with Radio Quantities

$\mu$	$\frac{1}{1,000,000}$	One-millionth	micro-
m	$\frac{1}{1,000}$	One-thousandth	milli-
c	$\frac{1}{100}$	One-hundredth	centi-
d	$\frac{1}{10}$	One-tenth	deci-
dk	1	One	uni-
h	10	Ten	deka-
k	100	One hundred	hekto-
	1,000	One thousand	kilo-
	10,000	Ten thousand	myria-
	1,000,000	One million	mega-

## Numbered Drill Sizes

Number	Diameter (mils)	Will Clear Screw	Drilled for Tapping Iron, Steel or Brass*
1	228.0	—	—
2	221.0	12-24	—
3	213.0	—	14-24
4	209.0	12-20	—
5	205.0	—	—
6	204.0	—	—
7	201.0	—	—
8	199.0	—	—
9	196.0	—	—
10	193.5	10-32	—
11	191.0	10-24	—
12	189.0	—	—
13	185.0	—	—
14	182.0	—	—
15	180.0	—	—
16	177.0	—	12-24
17	173.0	—	—
18	169.5	8-32	—
19	166.0	—	12-20
20	161.0	—	—
21	159.0	—	10-32
22	157.0	—	—
23	154.0	—	—
24	152.0	—	—
25	149.5	—	10-24
26	147.0	—	—
27	144.0	—	—
28	140.5	6-32	—
29	136.0	—	8-32
30	128.5	—	—
31	120.0	—	—
32	116.0	—	—
33	113.0	4-36 4-40	—
34	111.0	—	—
35	110.0	—	6-32
36	106.5	—	—
37	104.0	—	—
38	101.5	—	—
39	99.5	3-48	—
40	98.0	—	—
41	96.0	—	—
42	93.5	—	4-36 4-40
43	89.0	2-56	—
44	86.0	—	—
45	82.0	—	3-48

46	081.0	—	—
47	078.5	—	—
48	076.0	—	—
49	073.0	—	2-56
50	070.0	—	—
51	067.0	—	—
52	063.5	—	—
53	059.5	—	—
54	055.0	—	—

\* Use one size larger drill for tapping bakelite and hard rubber.

## Inductance Calculation

● The lumped inductance of coils for transmitting and receiving is fairly easy to calculate:

$$L = \frac{0.2 A^2 N^2}{3A + 9B + 10C}$$

where  $L$  is the inductance in microhenrys  
 $A$  is the mean diameter of the coil in inches  
 $B$  is the length of winding in inches  
 $C$  is the radial depth of winding in inches  
 $N$  is the number of turns.

The quantity  $C$  may be neglected if the coil is a single-layer solenoid, as is nearly always the case with coils for high frequencies.

For example, assume a coil having 35 turns of No. 30 d.s.c. wire on a receiving coil form having a diameter of 1.5 inches. Consulting the wire table, we find that 35 turns of No. 30 d.s.c. will occupy a length of one-half inch. Therefore,

$$\begin{aligned} A &= 1.5 \\ B &= .5 \\ N &= 35 \end{aligned}$$

and

$$L = \frac{0.2 \times (1.5)^2 \times (35)^2}{(3 \times 1.5) + (9 \times .5)}$$

or 61.25 microhenrys.

To calculate the number of turns of a single-layer coil:

$$N = \sqrt{\frac{3A + 9B}{0.2A^2} \times L}$$

## Figuring the Capacitance of a Condenser

$$\begin{aligned} C &= \frac{kA(n-1)}{4\pi d \times 9 \times 10^5} \\ &= .0088 \frac{kA}{d} (n-1) 10^{-5} \text{ mfd.} \end{aligned}$$

where  $A$  = area of one side of one plate (sq. cm.)

$n$  = total number of plates

$d$  = separation of plates (cm.)

$k$  = specific inductive capacity of dielectric.

The Specific Inductive Capacity ( $k$ ) is a property of the dielectric used in a condenser.

COPPER WIRE TABLE

Gauge No. B. & S.	Diam. in Mils <sup>1</sup>	Circular Mil Area	Turns per Linear Inch <sup>2</sup>				Turns per Square Inch <sup>2</sup>			Feet per Lb.		Ohms per 1000 ft. 25° C.	Current Carrying Capacity at 1500 C.M. per Amp. <sup>3</sup>	Diam. in mm.	Nearest British S.W.G. No.
			Enamel	S.S.C.	D.S.C. or S.C.C.	D.C.C.	S.C.C.	Enamel S.C.C.	D.C.C.	Bare	D.C.C.				
1	289.3	82690	—	—	—	—	—	—	—	3.947	—	.1264	55.7	7.348	1
2	257.6	66370	—	—	—	—	—	—	—	4.977	—	.1593	44.1	6.544	3
3	229.4	52640	—	—	—	—	—	—	—	6.276	—	.2009	35.0	5.827	4
4	204.3	41740	—	—	—	—	—	—	—	7.914	—	.2533	27.7	5.189	5
5	181.9	33100	—	—	—	—	—	—	—	9.980	—	.3195	22.0	4.621	7
6	162.0	26250	—	—	—	—	—	—	—	12.58	—	.4028	17.5	4.115	8
7	144.3	20820	—	—	—	—	—	—	—	15.87	—	.5080	13.8	3.665	9
8	128.5	16510	7.6	—	7.4	7.1	—	—	—	20.01	19.6	.6405	11.0	3.264	10
9	114.4	13090	8.6	—	8.2	7.8	—	—	—	25.23	24.6	.8077	8.7	2.906	11
10	101.9	10389	9.6	—	9.3	8.9	—	87.5	84.8	31.82	30.9	1.018	6.9	2.588	12
11	90.74	8234	10.7	—	10.3	9.8	110	105	80.0	40.12	38.8	1.284	5.5	2.305	13
12	80.81	6530	12.0	—	11.5	10.9	136	131	121	50.59	48.9	1.619	4.4	2.053	14
13	71.96	5178	13.5	—	12.8	12.0	170	162	150	63.80	61.5	2.042	3.5	1.828	15
14	64.08	4107	15.0	—	14.2	13.8	211	198	183	80.44	77.3	2.575	2.7	1.628	16
15	57.07	3257	16.8	—	15.8	14.7	262	250	223	101.4	97.3	3.247	2.2	1.450	17
16	50.82	2583	18.9	18.9	17.9	16.4	321	306	271	127.9	119	4.094	1.7	1.291	18
17	45.26	2048	21.2	21.2	19.9	18.1	397	372	329	161.3	150	5.163	1.3	1.150	18
18	40.30	1624	23.6	23.6	22.0	19.8	493	454	399	203.4	188	6.510	1.1	1.024	19
19	35.89	1288	26.4	26.4	24.4	21.8	592	553	479	256.5	237	8.210	.86	.9116	20
20	31.96	1022	29.4	29.4	27.0	23.8	775	725	625	323.4	298	10.35	.68	.8113	21
21	28.46	810.1	33.1	32.7	29.8	26.0	940	895	754	407.8	370	13.05	.54	.7230	22
22	25.35	642.4	37.0	36.5	34.1	30.0	1150	1070	910	514.2	461	16.46	.43	.6438	23
23	22.57	509.5	41.3	40.6	37.6	31.6	1400	1300	1080	648.4	584	20.76	.34	.5733	24
24	20.10	404.0	46.3	45.3	41.5	35.6	1700	1570	1260	817.7	745	26.17	.27	.5106	25
25	17.90	320.4	51.7	50.4	45.6	38.6	2060	1910	1510	1031	903	33.00	.21	.4547	26
26	15.94	254.1	58.0	55.6	50.2	41.8	2500	2300	1750	1300	1118	41.62	.17	.4049	27
27	14.20	201.5	64.9	61.5	55.0	45.0	3030	2780	2020	1639	1422	52.48	.13	.3606	29
28	12.64	159.8	72.7	68.6	60.2	48.5	3670	3350	2310	2067	1759	66.17	.11	.3211	30
29	11.26	126.7	81.6	74.8	65.4	51.8	4300	3900	2700	2607	2207	83.44	.084	.2859	31
30	10.03	100.5	90.5	83.3	71.5	55.5	5040	4660	3020	3287	2534	105.2	.067	.2546	33
31	8.928	79.70	101.	92.0	77.5	59.2	5920	5280	—	4145	2768	132.7	.053	.2268	34
32	7.950	63.21	113.	101.	83.6	62.6	7060	6250	—	5227	3137	167.3	.042	.2019	36
33	7.080	50.13	127.	110.	90.3	66.3	8120	7360	—	6591	4697	211.0	.033	.1798	37
34	6.305	39.75	143.	120.	97.0	70.0	9600	8310	—	8310	6168	266.0	.026	.1601	38
35	5.615	31.52	158.	132.	104.	73.5	10900	8700	—	10480	6737	335.0	.021	.1426	38-39
36	5.000	25.00	175.	143.	111.	77.0	12200	10700	—	13210	7877	423.0	.017	.1270	39-40
37	4.453	19.83	198.	154.	118.	80.3	—	—	—	16660	9309	533.4	.013	.1131	41
38	3.965	15.72	224.	166.	126.	83.6	—	—	—	21010	10666	672.6	.010	.1007	42
39	3.531	12.47	248.	181.	133.	86.6	—	—	—	26500	11907	848.1	.008	.0897	43
40	3.145	9.88	282.	194.	140.	89.7	—	—	—	33410	14222	1069	.006	.0799	44

<sup>1</sup> A mil is 1/1000 (one thousandth) of an inch.

<sup>2</sup> The figures given are approximate only, since the thickness of the insulation varies with different manufacturers.

<sup>3</sup> The current-carrying capacity at 1000 C.M. per ampere is equal to the circular-mil area (Column 3) divided by 1000.

# Resistor Wattage Chart

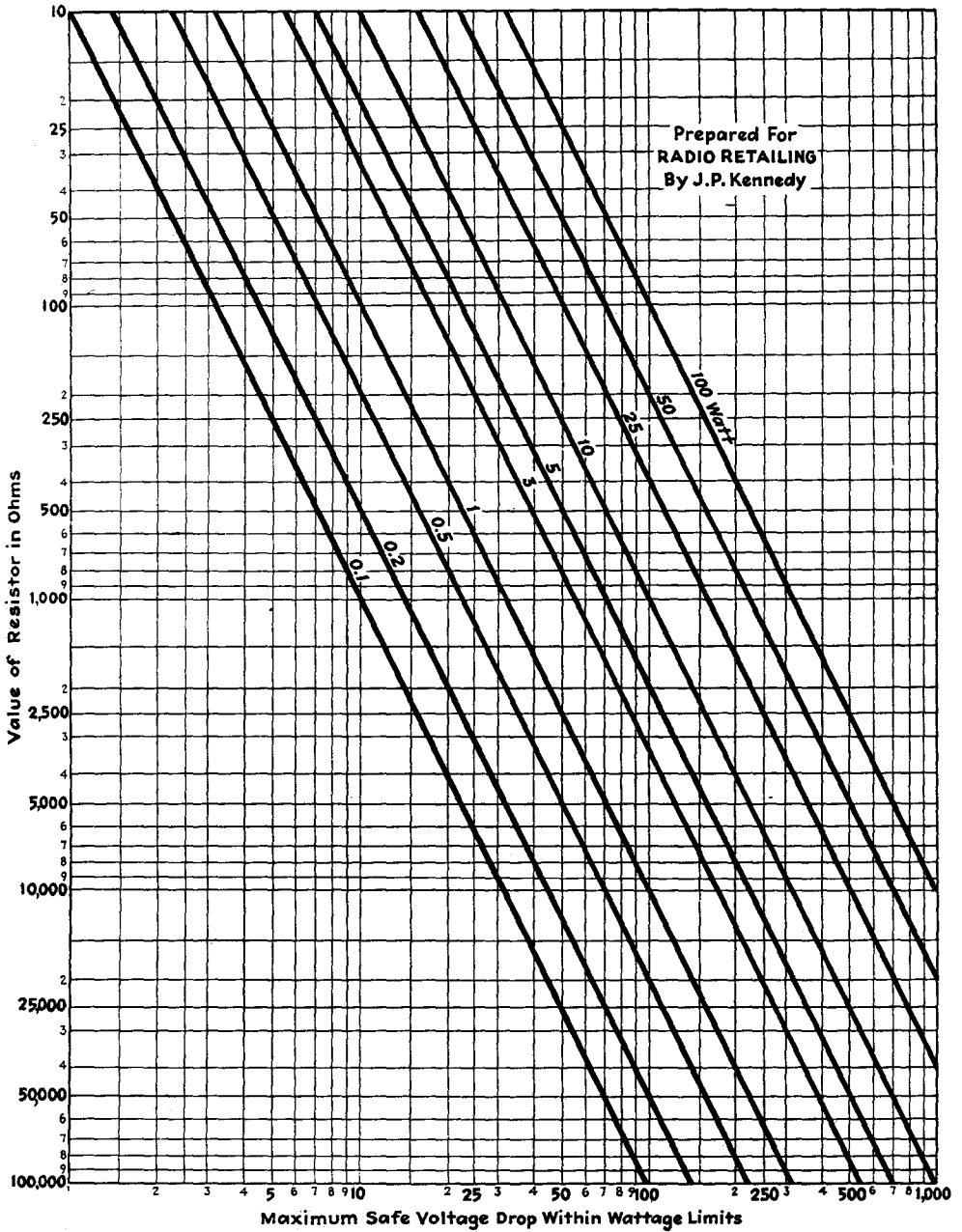

Reproduced by permission from *Radio Retailing*

# The Radio Amateur's Handbook . . . . .

It determines the quantity of charge which a given separation and area of plates will accumulate for a given applied voltage. The "inductivity" of the dielectric varies as in the above table. "k" is the ratio of the capacitance of a condenser with a given dielectric to the capacitance of the same instrument with air dielectric.

When the air dielectric in a variable condenser is replaced with some other fluid dielectric its maximum and minimum capacitance values are multiplied by "k" and the "sparking" potential is increased.

**Table of Dielectric Constants**

Dielectric	"k"	Puncture voltage	
		Kilovolts per cm.	Kilovolts per inch.
Air (normal pressure)	1.00	7.8-9.0	19.8-22.8
Flint Glass	6.6 to 10	900	2280
Mica	4.6 to 8	1500	3810
Paraffin Wax (solid)	2.0 to 2.5	400	1017
Sulphur	3.9 to 4.2	—	—
Castor Oil	4.7	150	381
Porcelain	4.4	—	—
Quartz	4.5	—	—
Resin	2.5	—	—
Olive Oil	3.1	120	305
Gutta Percha	3.3 to 4.9	80-200	203-508
Shellac	3.1	—	—
Common Glass	3.1 to 4.0	300-1500	762-3810
Turpentine	2.23	110-160	280-406
Dry Oak Wood	2.5 to 6.8	—	—
Formica Bakelite, etc.	5 to 6	—	—

Fluid dielectrics repair themselves after a breakdown unless an ore is maintained that carbonizes the oil. Dry oil is a good dielectric with quite low losses. When solid dielectric is used it should be borne in mind that dielectric strength (breakdown voltage) becomes lower as temperature rises. Breakdown is a function of time as well as voltage. A condenser that stands up under several thousand volts for a few seconds might break down when connected to a 2000-volt line for a half-hour.

Example of finding condenser capacitance: We have 3 plates, 3" x 5", in air. The plates are separated 1/8". 1" = 2.54 centimeters.

$$k = 1.A = 7.62 \times 12.70 = 96.8 \text{ sq. cm.}$$

$$d = .3175 \text{ cm. } n - 1 = 2.$$

$$C = .0088 \frac{1 \times 96.8}{.32} 2 \times 10^{-5} = .00005325$$

μfd. or 53 1/4 micromicrofarads.

The capacity formula becomes as follows, when A is the area of one side of one plate in square inches and d is the separation of the plate in inches.

$$C = .02235 \frac{kA}{d} (n - 1) 10^{-5} \mu\text{fd.}$$

If we put the condenser of our example in castor oil the increase in capacitance, owing to

the greater value of k, will make our condenser have a capacitance of

$$53 \frac{1}{4} \times 4.7 = 250 \text{ micromicrofarads.}$$

The air condenser might spark over at about 7.8 x .3175 cm. = 2.475 kv. (2,475 volts).

In oil (castor oil) it would have 150/7.8 (or 381/19.8) times the breakdown voltage of air.

$$\frac{150}{7.8} = 19.25$$

$$19 \frac{1}{4} \times 2475 = 47,600 \text{ volts}$$

We can find the same value directly:

$$150 \times .3175 \text{ cm.} = 47,600 \text{ volts (peak).}$$

Using the formulas for "reactance" we can find what the voltage drop across this condenser will be when carrying current at a specified high frequency.

$$E_x = X_c I \quad X_c = \frac{1}{2\pi f C}$$

where E<sub>x</sub> is the reactance voltage drop, C is the capacitance of the condenser (farads),

f is the frequency (cycles per second), X<sub>c</sub> is the reactance of the condenser in ohms.

Suppose we are using the 3-plate fixed air condenser in our antenna circuit, and that a radio-frequency ammeter is in series with it. We are operating on an 80-meter wavelength (3,750,000 cycles) and the meter right next to the condenser reads 1.3 amperes. What is the voltage drop across the air condenser?

$$X_c = \frac{1}{2(3.1416) (3,750,000) (53.25) 10^{-12}}$$

$$= \frac{1}{1257 \times 10^{-6}} = \frac{10^6}{1257} = 797 \text{ ohms}$$

$$E_x = (797) (1.3) = 1034 \text{ volts (root mean square value).}$$

If the wave is a sine wave, this value multiplied by 1.414 will give the "peak" or maximum value

$$1034 \times 1.414 = 1462 \text{ volts (peak)}$$

Our radio-frequency ammeter measures the heating effect of all the instantaneous values of current during the radio-frequency cycle. The direct current, the square of which equals the average of the squares of all the values of alternating current over a whole cycle, produces the same heat as the alternating current. Alternating current meters generally used for a.c. switchboard work read the effective or root mean square values which we mention above.

## Greek Alphabet

● Since Greek letters are used to stand for many electrical and radio quantities, the names and symbols of the Greek alphabet with the equivalent English characters are given.

# Appendix

Greek Letter	Greek Name	English Equivalent
Α α	Alpha	a
Β β	Beta	b
Γ γ	Gamma	g
Δ δ	Delta	d
Ε ε	Epsilon	e
Ζ ζ	Zeta	z
Η η	Eta	è
Θ θ	Theta	th
Ι ι	Iota	i
Κ κ	Kappa	k
Λ λ	Lambda	l
Μ μ	Mu	m
Ν ν	Nu	n
Ξ ξ	Xi	x
Ο ο	Omicron	ò
Π π	Pi	p
Ρ ρ	Rho	r
Σ σ	Sigma	s
Τ τ	Tau	t
Υ υ	Upsilon	u
Φ φ	Phi	ph
Χ χ	Chi	ch
Ψ ψ	Psi	ps
Ω ω	Omega	ò

### A.R.R.L. QSL Bureau

● For the convenience of its members, the League maintains a QSL-card forwarding system which operates through volunteer "District QSL Managers" in each of the nine U. S. and five Canadian districts. In order to secure such foreign cards as may be received for you, send your district manager a standard No. 8 stamped envelope. If you have reason to expect a considerable number of cards, put on an extra stamp so that it has a total of six-cents postage. Your own name and address go in the customary place on the face, and *your station call should be printed prominently in the upper left-hand corner*. When you receive cards, you should immediately furnish your QSL manager with another such envelope to replace the used one. List of managers is printed in each issue of *QST* and it is advisable to consult the current issue for this information, since changes occasionally take place. The managers as of October 15, 1935, were as follows:

- W1—J. T. Steiger, W1BGY, 35 Call Street, Willimansett, Mass.
- W2—H. W. Yahnel, W2SN, Lake Ave., Helmetta, N. J.
- W3—R. E. Macomber, W3CZE, 418 10th St., N. W., Washington, D. C.
- W4—B. W. Benning, W4CBY, 520 Whiteford Ave., Atlanta, Ga.

- W5—E. H. Treadaway, W5DKR, 2749 Myrtle St., New Orleans, La.
- W6—D. Cason Mast, W6KHV, 423 East E Street, Ontario, Calif.
- W7—Frank E. Pratt, W7DZX, 5023 So. Ferry St., Tacoma, Wash.
- W8—F. W. Allen, W8GER, 324 Richmond Ave., Dayton, Ohio.
- W9—George Dammann, W9JO, 319 Sherman Ave., Evanston, Ill.
- VE1—J. E. Roue, VE1FB, 84 Spring Garden Rd., Halifax, N. S.
- VE2—W. H. Oke, VE2AH, 5184 Mountain Sights Ave., N. D. G., Montreal, P. Q.
- VE3—Bert Knowles, VE3QB, Lanark, Ont.
- VE4—Dr. J. J. Dobry, VE4DR, Killam, Alberta.
- VE5—E. H. Cooper, VE5EC, 2024 Carnarvon St., Victoria, B. C.
- K4—F. McCown, K4RJ, Family Court 7, Santurce, Puerto Rico.
- K5—John J. Carr, K5AV, 78th Pursuit Squadron, Albrook Field, Canal Zone.
- K6—James F. Pa, K6LBH, 1416-D Lunalilo St., Honolulu, T. H.
- K7—Frank P. Barnes, K7DVF, Box 297, Wrangell, Alaska.
- KA—George L. Rickard, KA1GF, P. O. Box 849, Manila, P. I.

### Ham Abbreviations

● In amateur work many of the most commonly used radio and ordinary English words are frequently abbreviated, either by certain generally recognized methods or, as often occurs, on the spur of the moment according to the ideas of the individual operator. Beginning amateurs are likely to be confused by these "ham abbreviations" at first, but will probably pick them up quickly enough in the case of the more or less standard ones, and get the general idea governing the construction of the unusual ones occasionally encountered.

A method much used in short words is to give the first and last letters only, eliminating all intermediate letters. Examples: Now, nw; check, ck; would, wd.

Another method often used in short words employs phonetic spelling. Examples: Some, sum; good, gud; says, sez; night, nite.

A third method uses consonants only, eliminating all vowels. Examples: Letter, ltr; received, rod; message, msg.

Replacing parts of a word with the letter "x" is a system occasionally used in abbreviating certain words. Examples: Transmitter, xmtr; weather, wx; distance, dx; press, px.

In listing below a short list of some of the more frequently encountered amateur abbreviations, we want to caution the beginner against

# The Radio Amateur's Handbook . . . . .

making too great an effort to abbreviate or to scatter abbreviations wholesale throughout his radio conversation. A judicious use of certain of the short-cut words is permissible and saves time — the only legitimate object of abbreviations, of course. To abbreviate everything one sends, and to do so in many cases to extremes, is merely ridiculous.

ABT	About
ACCT	Account
AGN	Again
AHD	Ahead
AMP	Ampere
AMT	Amount
ANI	Any
AUSSIE	Australian amateur
BCL	Broadcast listener
BD	Bad
BI	By
BKG	Breaking
BLV	Believe
BN	Been, all between
BPL	Brass Pounders' League
BUG	Vibronex key
CANS	Phones
CK	Check
CKT	Circuit
CL-CLD	Closing station; call; called
CM	Communications Manager
CONGRATS	Congratulations
CRD	Card
CUD	Could
CUL	See you later
CW	Continuous wave
DH	Dead head
DL-DLVD	Delivered
DLY	Delivery
DX	Distance
ES	And
FB	Fine business, excellent
FIL	Filament
FM	From
FONES	Telephones
FR	For
FREQ	Frequency
GA	Go ahead (resume sending)
GB	Good-bye
GBA	Give better address
GE	Good evening
GG	Going
GM	Good morning
GN	Gone, good night
GND	Ground
GSA	Give some address
HAM	Amateur, brass-pounder
HI	Laughter, high
HR	Here, hear
HRD	Heard
HV	Have
ICW	Interrupted continuous wave
LID	"Lid," a poor operator
LTR	Later, letter
MA	Milliampere
MG	Motor-generator
MILS	Milliamperes
MO	Master oscillator
ND	Nothing doing
NIL	Nothing
NM	No more
NR	Number, near
NSA	No such address
NW	Now
OB	Old Boy, Official Broadcast
OM	Old man
OO	Official Observer

OPN	Operation
OP-OPR	Operator
ORS	Official Relay Station
OT	Old timer, old top
OW	Old woman
PSE	Please
PUNK	Poor operator
R	Are, all right, O.K.
RAC	Rectified alternating current
RCD	Received
RCVR	Receiver
RI	Radio Inspector
RM	Route Manager
SA	Say
SCM	Section Communications Manager
SED	Said
SEZ	Says
SIG-SG	Signature
SIGS	Signals
SINE	Sign, personal initials, signature
SKED	Schedule
TC	Thermocouple
TKS-TNX	Thanks
TNG	Thing
TMW	Tomorrow
TT	That
U	You
UR	Your, you're
URS	Yours
VT	Vacuum tube
VY	Very
WD	Would, word
WCS	Words
WKD	Worked
WKG	Working
WL	Will
WT	What, wait, wat
WUD	Would
WV-WL	Wave, wavelength
WX	Weather
XMTR	Transmitter
YL	Young lady
YR	Your
ZEDDER	New Zealander
73	Best regards
88	Love and kisses

## Effect of Coil Shields on Inductance

● Most amateurs are familiar with the fact that enclosing a coil in a shield decreases the inductance of the coil, but there has not, to our knowledge, heretofore been available a simple method for determining the extent of the decrease. An easily-applied graphical method of solving this problem has been worked out by the Radiotron Division of RCA Manufacturing Company and published as a tube application note.<sup>1</sup>

Considering the shield as a single turn having low resistance compared to its reactance, the following formula for inductance of the coil within the shield can be worked out:

$$L = L_a(1 - K^2)$$

where  $L$  is the desired inductance,  $L_a$  is the inductance of the coil outside the shield, and  $K^2$  is a factor depending upon the geometric dimensions of the coil and shield. Values of  $K^2$  have

<sup>1</sup> Application Note No. 48, Copyright, 1935, RCA Manufacturing Co., Inc.

CURVES FOR DETERMINATION OF DECREASE IN INDUCTANCE  
PRODUCED BY A COIL SHIELD

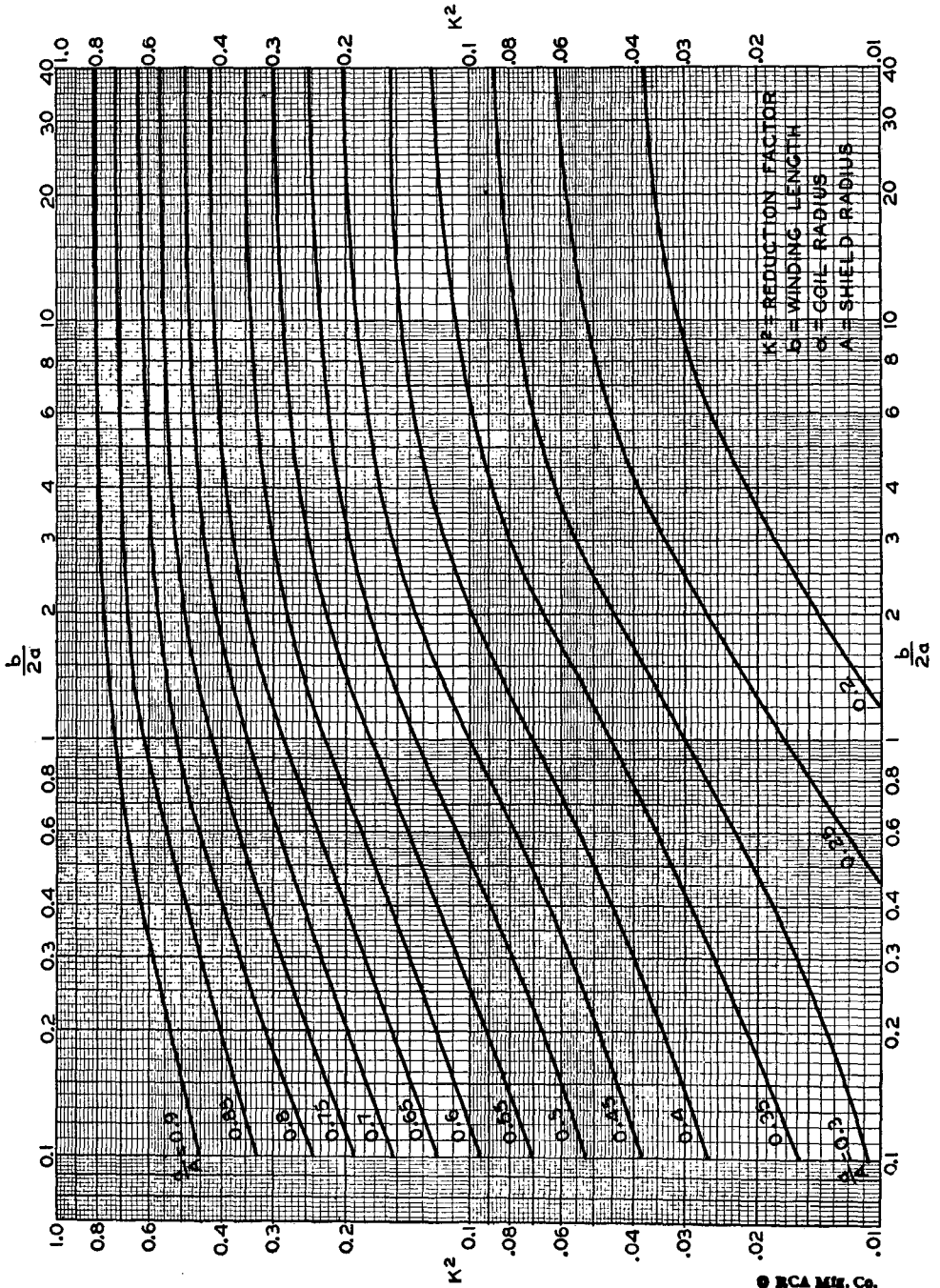

# The Radio Amateur's Handbook . . . . .

been plotted as a family of curves in the chart reproduced on the opposite page. The notations are as follows:

- $b$ —length of winding of coil
- $a$ —radius of coil
- $A$ —radius of shield

The curves are sufficiently accurate for all practical purposes throughout the range shown when the length of the shield is greater than that of the coil by at least the radius of the coil. If the shield can be square instead of circular,  $A$  may be taken as 0.6 times the width of one side. The reduction factor,  $K^2$ , is plotted against  $b/2a$  (ratio of length to diameter of coil), for a series of values of  $a/A$ , the ratio of coil radius to shield radius (or coil diameter to shield diameter).

The following example will illustrate the use of the chart. Assume an r.f. coil  $1\frac{1}{2}$  inches long and  $\frac{3}{4}$  inch in diameter to be used in a shield  $1\frac{1}{4}$  inches in diameter. The inductance-reducing effect of the shield is to be calculated. The values are:

$$\begin{aligned} b &= 1.5 \\ a &= 0.375 \\ A &= 0.625 \\ b/2a &= 1.5/0.75 = 2 \\ a/A &= 0.375/0.625 = 0.6 \end{aligned}$$

From the curves,  $K^2$  is 0.28; the inductance of the coil is therefore reduced 28% by the shield, or conversely, the inductance of the shield coil is 72% of its unshielded value.

It is interesting to note from inspection of the chart that the reduction in inductance does not start to become serious with coils of  $b/2a$  ratios of 2 or less, ordinarily used by amateurs, until the shield diameter becomes less than twice the coil diameter. With an  $a/A$  ratio of 0.5, the reduction in inductance will be of the order of 15%.

## Good Books

● Every amateur should maintain a carefully selected bookshelf; a few good books, consistently read and consulted, will add immeasurably to the interest and knowledge of the owner. We suggest a selection among the following works, all of which have been gone over carefully and are recommended in their various fields.

*Principles of Radio*, by Keith Henney, is an excellent book for the amateur who wants to acquire a better understanding of the fundamentals of radio transmission and reception. The book is thoroughly modern and, generally speaking, is a "non-mathematical" treatment. Recommended to every amateur. Price, \$3.50.

*Radio Engineering*, by Prof. F. E. Terman, is written from the viewpoint of the practical engineer engaged in design and experimental

work on modern transmitters and receivers and covers all phases of radio communication with the thoroughness of a complete reference book. A knowledge of advanced mathematics is helpful, but not necessary. Price, \$5.00.

An excellent theoretical work, requiring some knowledge of mathematics (algebra, at least) is *Elements of Radio Communication*, by Prof. J. H. Morecroft, price \$3.00. This is in the "first-year" student class. Perhaps the best known of all theoretical works is *Principles of Radio Communication*, by Morecroft, priced at \$7.50, but a familiarity with mathematics is essential to anyone who expects to derive much benefit from this book. The *Manual of Radio Telegraphy and Telephony*, by Admiral S. S. Robison, U.S.N., and published by the Naval Institute, covers both the theoretical and practical fields.

A monumental work on vacuum tubes has been made available recently in Dr. E. L. Chaffee's *Theory of Thermionic Vacuum Tubes*, based on his research and study at Harvard University. This book is of an advanced nature, but is particularly recommended because of its exhaustive and competent presentation.

*Fundamentals of Radio*, Second Edition, by R. R. Ramsey. A modernized revision of the author's work which has been a favorite with amateurs and experimenters since 1929. 426 pages, 439 illustrations. Price, \$3.50.

*Measurements in Radio Engineering*, by F. E. Terman. A comprehensive engineering discussion of the measurement problems encountered in engineering practice, with emphasis on basic principles rather than on methods in detail. A companion volume to the same author's *Radio Engineering*. 400 pages, including an appendix of outlines for laboratory experiments and a comprehensive index. 210 illustrations. Price, \$4.00.

*The Cathode-Ray Tube at Work*, by John F. Rider. Every owner and user of a cathode-ray oscilloscope should have his copy of this book. The first 109 pages are devoted to cathode-ray tube theory, sweep circuits, a.c. wave patterns and description of commercial oscilloscope units (the author prefers to call them "oscillographs"); the next 205 pages are packed with practical information on how to use them, including actual photographs of screen patterns representing just about every condition likely to be encountered in audio- and radio-frequency amplifiers, power supplies, complete receivers and transmitters. 322 pages, 444 illustrations. Price, \$2.50.

*Practical Radio Communication*, by A. R. Nilson and J. L. Hornung. A new modern treatment meeting the expanded scope of today's technical requirements in the various commercial fields. The first six chapters are de-



voted to principles, the remaining nine to latest practice in broadcasting, police systems, aviation radio and marine communication. 754 pages, including an appendix of tabulated data and a complete topical index. 434 illustrations. Price, \$5.00.

Two valuable books cover the general field of electricity and communications, with fitting emphasis on the radio aspects. *Electricity—What It Is and How It Acts*, by A. W. Kramer, is an easily understood treatment of modern electrical theory, including comprehensive discussions of vacuum-tube and electro-magnetic wave phenomena. It is written in two volumes, price \$2.00 each. *Communication Engineering*, by Prof. W. L. Everitt, is a thorough treatment of all types of communications networks. A certain amount of training in d.c. and a.c. current theory as well as mathematics through calculus is needed for fullest appreciation of this work. The price is \$5.00.

For the experimenter, there is Prof. R. R. Ramsey's *Experimental Radio*, price \$2.75, which describes in detail 128 experiments designed to bring out the principles of radio theory, instruments and measurements. There are two excellent books on high frequency measurements, intended primarily for serious experimenters and engineers. *Radio Frequency Electrical Measurements*, by H. A. Brown, is priced at \$4.00, while *High Frequency Measurements* by August Hund costs \$5.00.

*Radio Data Charts*, an English publication by R. T. Beatty, is a series of abacs (graphic charts) which enables most of the problems connected with radio design to be solved easily without recourse to mathematical calculations.

The amateur proposing to enter the commercial radio field would be well-advised to read *Making a Living in Radio*, by Zeh Bouck. This book is an impartial and comprehensive survey of the radio field, discussing opportunities, remunerative possibilities and probabilities, methods and costs of training, etc. It debunks many fallacies. The price is \$2.00; 222 pages with index, 25 illustrations.

Any of the above books may be obtained from the Book Department of the A.R.R.L. at the prices stated. Readers are referred to the Book Department's advertisement, in the advertising section of this Handbook, for a list which includes additional volumes of interest to amateurs.

*QST* is the official organ of the American Radio Relay League. It is published monthly, containing up-to-date information on amateur activities and describing the latest developments in amateur radio. It is a magazine devoted exclusively to the radio amateur. Written by and for the amateur, it contains knowledge

supplementary to the books we have mentioned. *QST* is found on the bookshelves of earnest amateurs and experimenters everywhere. Good books are a worth-while investment. A subscription to *QST* is equally valuable.

### Extracts from the Radio Law

● The complete text of the Communications Act of June 19, 1934, would occupy many pages. Only those parts most applicable to amateur radio station licensing and regulation in this country (with which every amateur should be familiar) are given. Note particularly Secs. 324, 325, 326, 605 and 606 and the penalties provided in Secs. 501 and 502.

*Be it enacted by the Senate and House of Representatives of the United States of America in Congress assembled,*

SECTION 1. For the purpose of regulating interstate and foreign commerce in communication by wire and radio so as to make available, so far as possible, to all the people of the United States a rapid, efficient, nation-wide, and world-wide wire and radio communication service with adequate facilities at reasonable charges, for the purpose of the national defense, and for the purpose of securing a more effective execution of this policy by centralizing authority heretofore granted by law to several agencies and by granting additional authority with respect to interstate and foreign commerce in wire and radio communication, there is hereby created a commission to be known as the "Federal Communications Commission," which shall be constituted as hereinafter provided, and which shall execute and enforce the provisions of this Act.

SEC. 2. (a) The provisions of this Act shall apply to all interstate and foreign communication by wire or radio and all interstate and foreign transmission of energy by radio, which originates and/or is received within the United States, and to all persons engaged within the United States in such communication or such transmission of energy by radio, and to the licensing and regulating of all radio stations as hereinafter provided; but it shall not apply to persons engaged in wire or radio communication or transmission in the Philippine Islands or the Canal Zone, or to wire or radio communication or transmission wholly within the Philippine Islands or the Canal Zone. . . .

SEC. 4. (a) The Federal Communications Commission (in this Act referred to as the "Commission") shall be composed of seven commissioners appointed by the President, by and with the advice and consent of the Senate, one of whom the President shall designate as chairman. . . .

SEC. 301. It is the purpose of this Act, among other things, to maintain the control of the United States over all the channels of interstate and foreign radio transmission; and to provide for the use of such channels, but not the ownership thereof, by persons for limited periods of time, under licenses granted by Federal authority, and no such license shall be construed to create any right, beyond the terms, conditions, and periods of the license. No person shall use or operate any apparatus for the transmission of energy or communications or signals by radio (a) from one place in any Territory or possession of the United States or in the District of Columbia to another place in the same Territory, possession, or District; or (b) from any State, Territory, or possession of the United States, or from the District of Columbia to any other State, Territory, or possession of the United States; or (c) from any place in any State, Territory, or possession of the United States, or in the District of Columbia, to any place in any foreign country or to any vessel; or (d) within any State when the effects of such use extend beyond the borders of said State, or when interference is caused by such use or operation with the transmission of such energy, communications, or signals from within said State to any place beyond its borders, or

# The Radio Amateur's Handbook . . . . .

from any place beyond its borders to any place within said State, or with the transmission or reception of such energy, communications, or signals from and/or to places beyond the borders of said State; or (e) upon any vessel or aircraft of the United States; or (f) upon any other mobile stations within the jurisdiction of the United States, except under and in accordance with this Act and with a license in that behalf granted under the provisions of this Act.

Sec. 303. Except as otherwise provided in this Act, the Commission from time to time, as public convenience, interest, or necessity requires, shall —

(a) Classify radio stations;  
(b) Prescribe the nature of the service to be rendered by each class of licensed stations and each station within any class;

(c) Assign bands of frequencies to the various classes of stations, and assign frequencies for each individual station and determine the power which each station shall use and the time during which it may operate;

(d) Determine the location of classes of stations or individual stations;

(e) Regulate the kind of apparatus to be used with respect to its external effects and the purity and sharpness of the emissions from each station and from the apparatus therein;

(f) Make such regulations not inconsistent with law as it may deem necessary to prevent interference between stations and to carry out the provisions of this Act: *Provided, however*, That changes in the frequencies, authorized power, or in the times of operation of any station, shall not be made without the consent of the station licensee unless, after a public hearing, the Commission shall determine that such changes will promote public convenience or interest or will serve public necessity, or the provisions of this Act will be more fully complied with;

(g) Study new uses for radio, provide for experimental uses of frequencies, and generally encourage the larger and more effective use of radio in the public interest; . . .

(j) Have authority to make general rules and regulations requiring stations to keep such records of programs, transmissions of energy, communications, or signals as it may deem desirable; . . .

(l) Have authority to prescribe the qualifications of station operators, to classify them according to the duties to be performed, to fix the forms of such licenses, and to issue them to such citizens of the United States as the Commission finds qualified;

(m) Have authority to suspend the license of any operator for a period not exceeding two years upon proof sufficient to satisfy the Commission that the licensee (1) has violated any provision of any Act or treaty binding on the United States which the Commission is authorized by this Act to administer or any regulation made by the Commission under any such Act or treaty; . . . or (3) has willfully damaged or permitted radio apparatus to be damaged; or (4) has transmitted superfluous radio communications or signals or radio communications containing profane or obscene words or language; or (5) has willfully or maliciously interfered with any other radio communications or signals;

(n) Have authority to inspect all transmitting apparatus to ascertain whether in construction and operation it conforms to the requirements of this Act, the rules and regulations of the Commission, and the license under which it is constructed or operated;

(o) Have authority to designate call letters of all stations;

(p) Have authority to cause to be published such call letters and such other announcements and data as in the judgment of the Commission may be required for the efficient operation of radio stations subject to the jurisdiction of the United States and for the proper enforcement of this Act; . . .

Sec. 309. (a) If upon examination of any application for a station license or for the renewal or modification of a station license the Commission shall determine that public interest, convenience, or necessity would be served by the granting thereof, it shall authorize the issuance, renewal, or modification thereof in accordance with said finding. In the event the Commission upon examination of any such appli-

cation does not reach such decision with respect thereto, it shall notify the applicant thereof, shall fix and give notice of a time and place for hearing thereon, and shall afford such applicant an opportunity to be heard under such rules and regulations as it may prescribe.

Sec. 318. The actual operation of all transmitting apparatus in any radio station for which a station license is required by this Act shall be carried on only by a person holding an operator's license issued hereunder. No person shall operate any such apparatus in such station except under and in accordance with an operator's license issued to him by the Commission.

Sec. 321. . . . (b) All radio stations, including Government stations and stations on board foreign vessels when within the territorial waters of the United States, shall give absolute priority to radio communications or signals relating to ships in distress; shall cease all sending on frequencies which will interfere with hearing a radio communication or signal of distress, and, except when engaged in answering or aiding the ship in distress, shall refrain from sending any radio communications or signals until there is assurance that no interference will be caused with the radio communications or signals relating thereto, and shall assist the vessel in distress, so far as possible, by complying with its instructions.

Sec. 324. In all circumstances, except in case of radio communications or signals relating to vessels in distress, all radio stations, including those owned and operated by the United States, shall use the minimum amount of power necessary to carry out the communication desired.

Sec. 325. (a) No person within the jurisdiction of the United States shall knowingly utter or transmit, or cause to be uttered or transmitted, any false or fraudulent signal of distress, or communication relating thereto, nor shall any broadcasting station rebroadcast the program or any part thereof of another broadcasting station without the express authority of the originating station. . . .

Sec. 326. Nothing in this Act shall be understood or construed to give the Commission the power of censorship over the radio communications or signals transmitted by any radio station, and no regulation or condition shall be promulgated or fixed by the Commission which shall interfere with the right of free speech by means of radio communication. No person within the jurisdiction of the United States shall utter any obscene, indecent, or profane language by means of radio communication.

Sec. 501. Any person who willfully and knowingly does or causes or suffers to be done any act, matter, or thing, in this Act prohibited or declared to be unlawful, or who willfully and knowingly omits or fails to do any act, matter, or thing in this Act required to be done, or willfully and knowingly causes or suffers such omission or failure, shall, upon conviction thereof, be punished for such offense, for which no penalty (other than a forfeiture) is provided herein, by a fine of not more than \$10,000 or by imprisonment for a term of not more than two years, or both.

Sec. 502. Any person who willfully and knowingly violates any rule, regulation, restriction, or condition made or imposed by the Commission under authority of this Act, or any rule, regulation, restriction, or condition made or imposed by any international radio or wire communications treaty or convention, or regulations annexed thereto, to which the United States is or may hereafter become a party, shall, in addition to any other penalties provided by law, be punished, upon conviction thereof, by a fine of not more than \$500 for each and every day during which such offense occurs.

Sec. 605. No person receiving or assisting in receiving, or transmitting, or assisting in transmitting, any interstate or foreign communication by wire or radio shall divulge or publish the existence, contents, substance, purport, effect, or meaning thereof, except through authorized channels of transmission or reception, to any person other than the addressee, his agent, or attorney, or to a person employed or authorized to forward such communication to its destination, or to proper accounting or distributing officers of the various communicating centers over which the communication may be passed, or to the master of a ship under whom he

is serving, or in response to a subpoena issued by a court of competent jurisdiction, or on demand of other lawful authority; and no person not being authorized by the sender shall intercept any communication and divulge or publish the existence, contents, substance, purport, effect, or meaning of such intercepted communication to any person; and no person not being entitled thereto shall receive or assist in receiving any interstate or foreign communication by wire or radio and use the same or any information therein contained for his own benefit or for the benefit of another not entitled thereto; and no person having received such intercepted communication or having become acquainted with the contents, substance, purport, effect, or meaning of the same or any part thereof, knowing that such information was so obtained, shall divulge or publish the existence, contents, substance, purport, effect, or meaning of the same or any part thereof, or use the same or any information therein contained for his own benefit or for the benefit of another not entitled thereto: *Provided*, That this section shall not apply to the receiving, divulging, publishing, or utilizing the contents of any radio communication broadcast, or transmitted by amateurs or others for the use of the general public, or relating to ships in distress.

Sec. 606. . . . (c) Upon proclamation by the President that there exists war or a threat of war or a state of public peril or disaster or other national emergency, or in order to preserve the neutrality of the United States, the President may suspend or amend, for such time as he may see fit, the rules and regulations applicable to any or all stations within the jurisdiction of the United States as prescribed by the Commission, and may cause the closing of any station for radio communication and the removal therefrom of its apparatus and equipment, or he may authorize the use or control of any such station and/or its apparatus and equipment by any department of the Government under such regulations as he may prescribe, upon just compensation to the owners.

## United States Amateur Regulations

● Pursuant to the basic communications law, general regulations for amateurs have been drafted by the Federal Communications Commission. The number before each regulation is its official number in the complete book of regulations for all classes of radio stations as issued by the Commission; since the amateur regulations are not all in one group, the numbers are not necessarily consecutive. The number of each regulation is of no consequence to the amateur, except as a means of reference.

Every amateur should be *thoroughly familiar* with these regulations and their effect, although, of course, it is not necessary to know the exact wording from memory.

The regulations printed here are those which were in effect as of October 1, 1936.

### RULES AND REGULATIONS GOVERNING AMATEUR RADIO STATIONS

103.6. Each application for an instrument of authorization shall be made in writing, under oath of the applicant, on a form prescribed and furnished by the Commission. . . . Separate application shall be filed for each instrument of authorization requested. . . . The required forms may be obtained from the Commission or from any of its field offices. (For a list of such offices and related geographical districts, see rule 30.)

103.7. Each application for . . . station license, with respect to the number of copies and place of filing, shall be submitted as follows: . . . g. Amateur . . . 1 copy to be sent as follows: (a) To proper district office if it requires personal appearance for operator examination under direct

supervision from that office; (b) Direct to Washington, D. C. in all other cases, including examinations for class C privileges.

103.14. An application for modification of license may be filed for . . . change in location. . . . Except when filed to cover construction permit, each application for modification of license shall be filed at least 60 days prior to the contemplated modification of license; *Provided, however*, That in emergencies and for good cause shown, the Commission may waive the requirements hereof insofar as time for filing is concerned.

103.15. Unless otherwise directed by the Commission, each application for renewal of license shall be filed at least 60 days prior to the expiration date of the license sought to be renewed.

104.7. If an applicant, by specific request of the Commission, is required to file any documents or information not included in the prescribed application forms, a failure to comply therewith shall constitute a defect in the application, and the application will not be considered by the Commission. Any application which is not filed in accordance with the Commission's regulations with respect to the form used, manner of execution, and completeness of answer to questions therein required, will not be considered by the Commission. Each such application shall be returned to the applicant by the Secretary of the Commission, together with a brief statement of the respect in which it is defective.

105.23. Any licensee receiving official notice of a violation of the terms of the Communications Act of 1934, any legislative act, Executive order, treaty to which the United States is a party or the rules and regulations of the Federal Communications Commission, which are binding upon licensee or the terms and conditions of a license, shall, within 3 days from such receipt, send a written reply direct to the Federal Communications Commission at Washington, D. C., and a copy thereof to the office of the Commission originating the official notice, when the originating office is other than the office of the Commission in Washington, D. C. The answer to each notice shall be complete in itself and shall not be abbreviated by reference to other communications or answer to other notices. If the notice relates to some violation that may be due to the physical or electrical characteristics of the transmitting apparatus, the answer shall state fully what steps, if any, are taken to prevent future violations, and if any new type apparatus is to be installed, the date such apparatus was ordered, the name of the manufacturer, and promised date of delivery. . . .

If the notice of violation relates to some lack of attention or improper operation of the transmitter, the name and license number of the operator in charge shall be given.

105.29. Whenever the Commission shall institute a revocation proceeding against the holder of any radio station construction permit or license under section 312(a), it shall initiate said proceeding by serving upon said licensee an order of revocation effective not less than 15 days after written notice thereof is given the licensee. The order of revocation shall contain a statement of the grounds and reasons for such proposed revocation and a notice of the licensee's right to be heard by filing with the Commission a written request for hearing within 15 days after receipt of said order. Upon the filing of such written request for hearing by said licensee the order of revocation shall stand suspended and the Commission will set a time and place for hearing and shall give the licensee and other interested parties notice thereof. If no request for hearing on any order of revocation is made by the licensee against whom such an order is directed within the time hereinabove set forth, the order of revocation shall become final and effective, without further action of the Commission. . . .

105.31. Proceedings for the suspension of an operator license shall in all cases be initiated by the entry of an order of suspension, a copy of which shall be served upon or mailed to the holder of the license involved, to become effective on a certain day, in no event less than 40 days after date of serving or mailing such order. The order shall set forth the name of the operator, class and grade of license, the effective date of the order, the period of suspension, and a statement of the reasons for suspension, and shall contain a notice to the

# The Radio Amateur's Handbook . . . . .

holder of such license of his right to be heard and contest the order, by filing with the Commission within 35 days from the receipt of said order, a written request for hearing with a statement executed by him under oath, denying or explaining specifically and in detail the charges set forth in the order of suspension. Upon receipt of such request and statement, the effective date of the suspension of such license will be extended; and the Commission, upon consideration of the licensee's statement, as herein provided, will either revoke its order of suspension, or fix a time and place for hearing, and notify the licensee thereof.

If no request for hearing on any order of suspension is made by the licensee against whom such order is directed within 35 days of receipt of such order of suspension, the same shall become final and effective.

Where any order of suspension has become final, the person whose license has been suspended shall forthwith send the operator's license in question to the office of the Commission in Washington, D. C.

27. All station licenses will be issued so as to expire at the hour of 3 a.m., eastern standard time. The normal license periods and expiration dates are as follows:

(e) The licenses for amateur stations will be issued for a normal license period of three years from the date of expiration of old license or the date of granting a new license or modification of a license.

28. Insofar as practicable, call signals of radio stations will be designated in alphabetical order from groups available for assignment, depending upon the class of station to be licensed. Because of the large number of amateur stations, calls will be assigned thereto in regular order and requests for particular calls will not be considered, except on formal application the Commission may reassign calls to the last holders of record.

29. Call signals of stations will be deleted in each of the following cases:

(a) Where an existing instrument of authorization has expired and no application for renewal or extension thereof has been filed.

(b) Where a license has been revoked.

(c) Where a license is surrendered or cancelled.

(d) Other cause, such as death, loss of citizenship, or adjudged insanity of the station licensee. Such occurrences coming to notice should be reported to the Commission, preferably accompanied by the station license for cancellation, if available.

30. The following list of the radio districts gives the address of each field office of the Federal Communications Commission and the territory embraced in each district. [This list is reproduced on the last page of this booklet.—Ed.]

(a) The following is a list of the cities where examinations will be held for radio operators' licenses in addition to Washington, D. C., and the radio district offices of the Commission. Other cities may also be designated from time to time for the purpose of conducting commercial operators' examinations only: (See Rules 2, 404, and 408.)

Schenectady, N. Y.	St. Louis, Mo.
Winston-Salem, N. C.	Pittsburgh, Pa.
Nashville, Tenn.	Cleveland, Ohio
San Antonio, Tex.	Cincinnati, Ohio
Oklahoma City, Okla.	Columbus, Ohio
Des Moines, Iowa	

Examinations for commercial and Class A amateur privileges will be conducted not more than twice per year in the following cities, which are not to be construed as examining cities under the rules which apply for Class B and C amateur privileges:

Albuquerque, New Mexico	Jacksonville, Florida
Billings, Montana	Little Rock, Arkansas
Bismarck, North Dakota	Phoenix, Arizona
Boise, Idaho	Salt Lake City, Utah
Butte, Montana	Spokane, Washington

188. The term "station" means all of the radio-transmitting apparatus used at a particular location for one class of service and operated under a single instrument of authorization. In the case of every station other than broadcast, the location of the station shall be considered as that of the radiating antenna.

192. The term "portable station" means a station so constructed that it may conveniently be moved about from place to place for communication and that is in fact so moved about from time to time, but not used while in motion.

(a) The term "portable-mobile station" means a station so constructed that it may conveniently be moved from one mobile unit to another for communication, and that is, in fact, so moved about from time to time and ordinarily used while in motion.

204. Allocations of bands of frequencies to services, such as mobile, fixed, broadcast, amateur, etc., are set forth in Article 5 of the General Regulations annexed to the International Radiotelegraph Convention and in the North American Radio Agreement. These allocations will be adhered to in all assignments to stations capable of causing international interference.

207. Licensees shall use radio transmitters, the emissions of which do not cause interference, outside the authorized band, that is detrimental to traffic and programs of other authorized stations.

210. Radio communications or signals relating to ships or aircraft in distress shall be given absolute priority. Upon notice from any station, Government or commercial, all other transmission shall cease on such frequencies and for such time as may, in any way, interfere with the reception of distress signals or related traffic.

213. One or more licensed operators, of grade specified by these regulations, shall be on duty at the place where the transmitting apparatus of each station is located and whenever it is being operated; provided, however, that for a station licensed for service other than broadcast, and remote control is used, the Commission may modify the foregoing requirement upon proper application and showing being made, so that such operator or operators may be on duty at the control station in lieu of the place where the transmitting apparatus is located. Such modification shall be subject to the following conditions:

(a) The transmitter shall be capable of operation and shall be operated in accordance with the terms of the station license.

(b) The transmitter shall be monitored from the control station with apparatus that will permit placing the transmitter in an inoperative condition in the event there is a deviation from the terms of the license, in which case the radiation of the transmitter shall be suspended immediately until corrective measures are effectively applied to place the transmitter in proper condition for operation in accordance with the terms of the station license.

(c) The transmitter shall be so located or housed that it is not accessible to other than duly authorized persons.

214. Only an operator holding a radiotelegraph class of operators' license may manipulate the transmitting key of a manually operated coastal telegraph or mobile telegraph station in the international service; and only a licensed amateur operator may manipulate the transmitting key at a manually operated amateur station. The licensees of other stations operated under the constant supervision of duly licensed operators may permit any person or persons, whether licensed or not, to transmit by voice or otherwise, in accordance with the types of emission specified by the respective licenses.

220. Licensees of stations other than broadcast stations are authorized to carry on such routine tests as may be required for the proper maintenance of the stations, provided, however, that these tests shall be so conducted as not to cause interference with the service of other stations.

221. The original of each station license, except amateur, portable and portable-mobile stations shall be posted by the licensee in a conspicuous place in the room in which the transmitter is located. In the case of amateur, portable, and portable-mobile stations the original license, or a photostat copy thereof, shall be similarly posted or kept in the personal possession of the operator on duty.

(a) The original license of each station operator, except amateur and aircraft radio station operators, and operators of portable and portable-mobile stations, shall be posted in a conspicuous place in the room occupied by such operator

# Appendix

while on duty. In the case of an amateur or aircraft radio operator, and operators of portable or portable-mobile stations, the original operator's license shall be similarly posted or kept in his personal possession and available for inspection at all times while the operator is on duty.

(b) When an operator's license cannot be posted because it has been mailed to an office of the Federal Communications Commission for endorsement or other change, such operator may continue to operate stations in accordance with the class of license held, for a period not to exceed sixty days, but in no case beyond the date of expiration of the license.

361. The term "amateur service" means a radio service carried on by amateur stations.

362. The term "amateur station" means a station used by an "amateur," that is, a duly authorized person interested in radio technique solely with a personal aim and without pecuniary interest.

364. The term "amateur radio operator" means a person holding a valid license issued by the Federal Communications Commission who is authorized under the regulations to operate amateur radio stations.

365. The term "amateur radiocommunication" means radiocommunication between amateur radio stations solely with a personal aim and without pecuniary interest.

366. An amateur station license may be issued only to a licensed amateur radio operator who has made a satisfactory showing of ownership or control of proper transmitting apparatus; provided, however, that in the case of a military or naval reserve radio station located in approved public quarters and established for training purposes, but not operated by the United States Government, a station license may be issued to the person in charge of such station who may not possess an amateur operator's license.

(a) An amateur operator's license may be granted to a person who does not desire an amateur station license, provided such applicant waives his right to apply for an amateur station license for ninety days subsequent to the date of application for operator's license.

367. Amateur radio station licenses shall not be issued to corporations, associations, or other organizations; provided, however, that in the case of a bona fide amateur radio society, a station license may be issued to a licensed amateur radio operator as trustee for such society.

368. Licenses for mobile stations and portable-mobile stations will not be granted to amateurs for operation on frequencies below 28,000 kilocycles. However, the licensee of a fixed amateur station may operate portable amateur stations (Rule 192) in accordance with the provisions of Rules 384, 386 and 387; and also portable and portable-mobile amateur stations (Rules 192 and 192a) on authorized amateur frequencies above 28,000 kilocycles in accordance with Rules 384 and 386, but without regard to Rule 387.

370. Amateur stations shall be used only for amateur service, except that in emergencies or for testing purposes they may be used also for communication with commercial or Government radio stations. In addition, amateur stations may communicate with any mobile radio station which is licensed by the Commission to communicate with amateur stations, and with stations of expeditions which may also be authorized to communicate with amateur stations.

371. Amateur stations shall not be used for broadcasting any form of entertainment nor for the simultaneous retransmission by automatic means of programs or signals emanating from any class of station other than amateur.

372. Amateur stations may be used for the transmission of music for test purposes of short duration in connection with the development of experimental radiotelephone equipment.

373. Amateur radio stations shall not be used to transmit or receive messages for hire, nor for communication for material compensation, direct or indirect, paid or promised.

374. The following bands of frequencies are allocated exclusively for use by amateur stations:

1,715 to 2,000 kc.	28,000 to 30,000 kc.
3,500 to 4,000 "	56,000 to 60,000 "
7,000 to 7,300 "	400,000 to 401,000 "
14,000 to 14,400 "	

374a. The licensee of an amateur station may, subject

to change upon further order, operate amateur stations on any frequency above 110,000 kilocycles, without separate licenses therefor, provided:

(1) That such operation in every respect complies with the Commission's rules governing the operation of amateur stations in the amateur service.

(2) That records are maintained of all transmissions in accordance with the provisions of Rule 386.

375. All bands of frequencies so assigned may be used for radiotelegraphy, type A-1 emission. Type A-2 emission may be used in the following bands of frequencies only:

28,000 to 30,000 kc.
56,000 to 60,000 "
400,000 to 401,000 "

376. The following bands of frequencies are allocated for use by amateur stations using radiotelephony, type A-3 emission:

1,800 to 2,000 kc.	56,000 to 60,000 kc.
28,000 to 29,000 "	400,000 to 401,000 "

377. Provided the stations shall be operated by a person who holds an amateur operator's license endorsed for class A privileges, an amateur radio station may use radiotelephony, type A-3 emission, in the following additional bands of frequencies:

3,900 to 4,000 kc.	14,150 to 14,250 kc.
--------------------	----------------------

378. The following bands of frequencies are allocated for use by amateur stations for television, facsimile, and picture transmission:

1,715 to 2,000 kc.
56,000 to 60,000 "

379. Transmissions by an amateur station may be on any frequency within an amateur band above assigned.

380. An amateur radio station shall not be located upon premises controlled by an alien.

381. Spurious radiations from an amateur transmitter operating on a frequency below 30,000 kilocycles shall be reduced or eliminated in accordance with good engineering practice and shall not be of sufficient intensity to cause interference on receiving sets of modern design which are tuned outside the frequency band of emission normally required for the type of emission employed. In the case of A-3 emission, the transmitter shall not be modulated in excess of its modulation capability to the extent that interfering spurious radiations occur, and in no case shall the emitted carrier be amplitude-modulated in excess of 100 per cent. Means shall be employed to insure that the transmitter is not modulated in excess of its modulation capability. A spurious radiation is any radiation from a transmitter which is outside the frequency band of emission normal for the type of transmission employed, including any component whose frequency is an integral multiple or sub-multiple of the carrier frequency (harmonics and sub-harmonics), spurious modulation products, key clicks and other transient effects, and parasitic oscillations.

382. Licensees of amateur stations using frequencies below 30,000 kilocycles, shall use adequately filtered direct-current power supply for the transmitting equipment, to minimize frequency modulation and to prevent the emission of broad signals.

383. Licensees of amateur stations are authorized to use a maximum power input of one kilowatt to the plate circuit of the final amplifier stage of an oscillator-amplifier transmitter or to the plate circuit of an oscillator transmitter.

384. An operator of an amateur station shall transmit its assigned call at least once during each fifteen minutes of operation and at the end of each transmission. In addition, an operator of an amateur portable or portable-mobile radiotelegraph station shall transmit immediately after the call of the station, the break sign (BT) followed by the number of the amateur call area in which the portable or portable-mobile amateur station is then operating, as for example:

*Example 1.* Portable or portable-mobile amateur station operating in the third amateur call area calls a fixed amateur station: W1ABC W1ABC W1ABC DE W2DEF BT3 W2DEF BT3 W2DEF BT3 AR.

# The Radio Amateur's Handbook . . . . .

*Example 2.* Fixed amateur station answers the portable or portable-mobile amateur station: W2DEF W2DEF W2DEF DE W1ABC W1ABC W1ABCK.

*Example 3.* Portable or portable-mobile amateur station calls a portable or portable-mobile amateur station: W3GHI W3GHI W3GHI DE W4JKL BT4 W4JKL BT4 W4JKL BT4 AR.

If telephony is used, the call sign of the station shall be followed by an announcement of the amateur call area in which the portable or portable-mobile station is operating.

384a. In the case of an amateur licensee whose station is licensed to a regularly commissioned or enlisted member of the United States Naval Reserve, the Commandant of the naval district in which such reservist resides may authorize in his discretion the use of the call letter prefix "N," in lieu of the prefix "W," or "K," assigned in the license issued by the Commission, provided that such "N" prefix shall be used only when operating in the frequency bands 1715-2000 kilocycles and 3500-4000 kilocycles in accordance with instructions to be issued by the Navy Department.

385. In the event that the operation of an amateur radio station causes general interference to the reception of broadcast programs with receivers of modern design, that amateur station shall not operate during the hours from 8 o'clock p.m. to 10:30 p.m., local time, and on Sundays from 10:30 a.m. until 1 p.m., local time, upon such frequency or frequencies as cause such interference.

386. Each licensee of an amateur station shall keep an accurate log of station operation to be made available upon request by authorized Government representatives, as:

a. The date and time of each transmission. (The date need only be entered once for each day's operation. The expression "time of each transmission" means the time of making a call and need not be repeated during the sequence of communication which immediately follows; however, an entry shall be made in the log when "signing off" so as to show the period during which communication was carried on.)

b. The name of the person manipulating the transmitting key of a radiotelegraph transmitter or the name of the person operating a transmitter of any other type (type A-3 or A-4 emission) with statement as to type of emission. (The name need only be entered once in the log provided the log contains a statement to the effect that all transmissions were made by the person named except where otherwise stated. The name of any other person who operates the station shall be entered in the proper space for his transmissions.)

c. Call letters of the station called. (This entry need not be repeated for calls made to the same station during any sequence of communication provided the time of "signing off" is given.)

d. The input power to the oscillator, or to the final amplifier stage where an oscillator-amplifier transmitter is employed. (This need be entered only once provided the input power is not changed.)

e. The frequency band used. (This information need be entered only once in the log for all transmissions until there is a change in frequency to another amateur band.)

f. The location of a portable or portable-mobile station at the time of each transmission. (This need be entered only once, provided the location of the station is not changed. However, suitable entry shall be made in the log upon changing location, showing the type of vehicle or mobile unit in which the station is operated, and the approximate geographical location of the station at the time of operation.)

g. The message traffic handled. (If record communications are handled in regular message form, a copy of each message sent and received shall be entered in the log or retained on file for at least one year.)

387. Advance notice of all locations in which portable amateur stations will be operated shall be given by the licensee to the Inspector-in-Charge of the district in which the station is to be operated. Such notices shall be made by letter or other means prior to any operation contemplated and shall state the station call, name of licensee, the date of proposed operation and the approximate locations, as by city, town, or county. An amateur station operating under

this rule shall not be operated during any period exceeding thirty days without giving further notice to the Inspector-in-Charge of the radio district in which the station will be operated. This rule does not apply to the operation of portable or portable-mobile amateur stations on frequencies above 28,000 kilocycles authorized to be used by amateur stations. (See Rule 368.)

400. An amateur station may be operated only by a person holding a valid amateur operator's license, and then only to the extent provided for by the class of privileges for which the operator's license is endorsed.

401. Amateur operators' licenses are valid only for the operation of licensed amateur stations, provided, however, any person holding a valid radio operators' license of any class may operate stations in the experimental service licensed for, and operating on, frequencies above 30,000 kilocycles.

402. Amateur station licenses and/or amateur operator licenses may, upon proper application, be renewed provided: (1) the applicant has used his station to communicate by radio with at least three other amateur stations during the three-month period prior to the date of submitting the application, or (2) in the case of an applicant possessing only an operator's license, that he has similarly communicated with amateur stations during the same period. Proof of such communication must be included in the application by stating the call letters of the stations with which communication was carried on and the time and date of each communication. Lacking such proof, the applicant will be ineligible for a license for a period of ninety days. This rule shall not prevent renewal of an amateur station license to an applicant who has recently qualified for license as an amateur operator.

403. There shall be but one main class of amateur operator's license to be known as "amateur class" but each such license shall be limited in scope by the signature of the examining officer opposite the particular class or classes of privileges which apply, as follows:

*Class A.* Unlimited privileges.

*Class B.* Unlimited radiotelephone amateur stations to the following bands of frequencies: 1800 to 2000 kilocycles; 28,000 to 28,500 kilocycles; 56,000 to 60,000 kilocycles; 400,000 to 401,000 kilocycles.

*Class C.* Same as Class B privileges, except that the Commission may require the licensee to appear at an examining point for a supervisory written examination and practical code test during the license term. Failing to appear for examination when directed to do so, or failing to pass the supervisory examination, the license held will be cancelled and the holder thereof will not be issued another license of the Class C privileges.

404. The scope of examinations for amateur operators' licenses shall be based on the class of privileges the applicant desires, as follows:

*Class A.* To be eligible for examination for the Class A amateur operator's privileges, the applicant must have been a licensed amateur operator for at least one year and must personally appear at one of the Commission's examining offices, and take the supervisory written examination and code test. (See Rules 2 (2) a, 30 and 408.) Examinations will be conducted at Washington, D. C., on Thursday of each week, and at each radio district office of the Commission on the days designated by the Inspector-in-Charge of such offices. In addition, examinations will be held quarterly in the examining cities listed in Rule 30 on the dates to be designated by the Inspector-in-Charge of the radio district in which the examining city is situated. The examination will include the following:

(a) Applicant's ability to send and receive in plain language messages in the Continental Morse Code (5 characters to the word) at a speed of not less than 13 words per minute.

(b) Technical knowledge of amateur radio apparatus, both telegraph and telephone.

(c) Knowledge of the provisions of the Communications Act of 1934 as amended, subsequent acts, treaties, and rules and regulations of the Federal Communications Commission, affecting amateur licensees.

## Appendix

*Class B.* The requirements for Class B amateur operator's privileges are similar to those for the Class A, except that no experience is required and the questions on radiotelephone apparatus are not so comprehensive in scope.

*Class C.* The requirements for Class C amateur operator's privileges shall be the same as for the Class B except the examination will be given by mail. Applicants for Class-C privileges must reside more than 125 miles from the nearest examining point for Class-B privileges, or in a camp of the Civilian Conservation Corps, or be in the regular military or naval service of the United States at a military post or naval station; or be shown by physician's certificate to be unable to appear for examination due to protracted disability.

405. An applicant for any class of amateur operator's privileges who has held a radiotelephone second class operator's license or higher, or an equivalent commercial grade license, or who has been accorded unlimited amateur radiotelephone privileges, within five years of the date of application may only be required to submit additional proof as to code ability and/or knowledge of the laws, treaties, and regulations affecting amateur licensees.

406. An applicant for the Class B or C amateur operator's privileges who has held a radiotelegraph third class operator's license or higher, or an equivalent commercial grade license, or who has held an amateur extra first class license within five years of the date of application may be accorded a license by passing an examination in laws, treaties, and regulations affecting amateur licensees.

407. An applicant for Class C amateur operator's privileges must have his application signed in the presence of a person authorized to administer oaths, by (1) a licensed radiotelegraph operator other than an amateur operator possessing only the Class C privileges or former temporary amateur class license, or (2) by a person who can show evidence of employment as a radiotelegraph operator in the Government service of the United States. In either case the radiotelegraph code examiner shall attest to the applicant's ability to send and receive messages in plain language in the Continental Morse Code (5 characters to the word) at a speed of not less than 18 words per minute. The code certification may be omitted if the applicant can show proof of code ability in accordance with the preceding rule.

408. Forms for amateur station and/or operator license shall be obtained by calling or writing to the Inspector-in-Charge of the radio inspection district in which the applicant resides. Upon completion of the forms they shall be sent

back to the same office where the final arrangements will be made for the examination: *Provided*, however, in the case of applicants for the Class C amateur operator's privileges, the forms and examination papers when completed shall be mailed direct to the Federal Communications Commission, Washington, D. C.

409. The percentage that must be obtained as a passing mark in each examination is 75 out of a possible 100. No credit will be given in the grading of papers for experience or knowledge of the code. If an applicant answers only the questions relating to laws, treaties, and regulations by reason of his right to omit other subjects because of having held a recognized class of license, a percentage of 75 out of a possible 100 must be obtained on the questions answered.

410. An amateur station license shall be issued so as to run concurrently with the amateur operator's license and both licenses shall run for three years from the date of issuance. If either the station license or the operator's license is modified during the license term, both licenses shall be re-issued for the full three-year term, provided, however, if an operator's license is modified only with respect to the class of operator's privileges, the old license may be endorsed in which case the expiration date will not change.

411. Eligibility for re-examination. An applicant who fails examination for amateur privileges may not take another examination for such privileges within ninety days, except that this rule shall not apply to successive examinations at a point named in Rule 30-A.

412. Any attempt to obtain an operator's license by fraudulent means or by attempting to impersonate another, or copying or divulging questions used in examinations, or, if found unqualified or unfit, will constitute a violation of the regulations for which the licensee may suffer suspension of license or be refused a license and/or debarment from further examination for a period not exceeding two years at the discretion of the licensing authority.

413. Any licensee applying for a duplicate license to replace an original which has been lost, mutilated, or destroyed, shall submit an affidavit to the Commission attesting to the facts regarding the manner in which the original was lost. Duplicates will be issued in exact conformity with the original, and will be marked "duplicate" on the face of the license.

414. Licenses are not valid until the oath of secrecy has been executed and the signature of the licensee affixed thereto.

415. All examinations, including the code test, must be written in longhand by the applicant.

# *The Radio Amateur's Handbook* . . . . .

## UNITED STATES RADIO DISTRICTS

<i>District</i>	<i>Territory</i>	<i>Address, Radio Inspector-in-Charge</i>
No. 1	The States of Connecticut, Maine, Massachusetts, New Hampshire, Rhode Island and Vermont.	Customhouse, Boston, Mass.
No. 2	The counties of Albany, Bronx, Columbia, Delaware, Dutchess, Greene, Kings, Nassau, New York, Orange, Putnam, Queens, Rensselaer, Richmond, Rockland, Schenectady, Suffolk, Sullivan, Ulster and Westchester of the State of New York; and the counties of Bergen, Essex, Hudson, Hunterdon, Mercer, Middlesex, Monmouth, Morris, Passaic, Somerset, Sussex, Union and Warren of the State of New Jersey.	Federal Building, 641 Washington St., New York, N. Y.
No. 3	The counties of Adams, Berks, Bucks, Carbon, Chester, Cumberland, Dauphin, Delaware, Lancaster, Lebanon, Lehigh, Monroe, Montgomery, Northampton, Perry, Philadelphia, Schuylkill and York of the State of Pennsylvania; and the counties of Atlantic, Burlington, Camden, Cape May, Cumberland, Gloucester, Ocean and Salem of the State of New Jersey; and the county of Newcastle of the State of Delaware.	Room 1200, U. S. Customhouse, Second and Chestnut Sts., Philadelphia, Pa.
No. 4	The State of Maryland; the District of Columbia; the counties of Arlington, Clark, Fairfax, Fauquier, Frederick, Loudoun, Page, Prince William, Rappahannock, Shenandoah and Warren of the State of Virginia; and the counties of Kent and Sussex of the State of Delaware.	Fort McHenry, Baltimore, Md.
No. 5	The State of Virginia except that part lying in District 4, and the State of North Carolina except that part lying in District 6.	402 New Post Office Bldg., Norfolk, Va.
No. 6	The States of Alabama, Georgia, South Carolina, and Tennessee; and the counties of Ashe, Avery, Buncombe, Burke, Caldwell, Cherokee, Clay, Cleveland, Graham, Haywood, Henderson, Jackson, McDowell, Macon, Madison, Mitchell, Polk, Rutherford, Swain, Transylvania, Watauga and Yancey of the State of North Carolina.	411 New Post Office Bldg., Atlanta, Ga.
No. 7	The State of Florida, Puerto Rico, and the Virgin Islands.	P. O. Box 150, Miami, Fla.
No. 8	The States of Arkansas, Louisiana and Mississippi; and the city of Texarkana in the State of Texas.	Customhouse, New Orleans, La.
No. 9	The counties of Arkansas, Brazoria, Brooks, Calhoun, Cameron, Chambers, Fort Bend, Galveston, Goliad, Harris, Hidalgo, Jackson, Jefferson, Jim Wells, Kenedy, Kleberg, Matagorda, Nueces, Refugio, San Patricio, Victoria, Wharton and Willacy of the State of Texas.	209 Prudential Building, Galveston, Tex.
No. 10	The State of Texas except that part lying in District 9 and in the city of Texarkana; and the States of Oklahoma and New Mexico.	464 Federal Building, Dallas, Tex.
No. 11	The State of Arizona; the county of Clarke in the State of Nevada; and the counties of Imperial, Inyo, Kern, Los Angeles, Orange, Riverside, San Bernardino, San Diego, San Luis Obispo, Santa Barbara, and Ventura of the State of California.	1105 Rives-Strong Building, Los Angeles, Calif.
No. 12	The State of California except that part lying in District 11; the State of Nevada except the county of Clarke; the Hawaiian Islands, Guam and American Samoa.	Customhouse, San Francisco, Cali
No. 13	The State of Oregon; and the State of Idaho except that part lying in District 14.	207 New U. S. Courthouse Bldg Portland, Ore.
No. 14	The Territory of Alaska; the State of Washington; the counties of Benewah, Bonner, Boundary, Clearwater, Idaho, Kootenai, Latah, Lewis, Nez Perce and Shoshone of the State of Idaho; the counties of Beaverhead, Broadwater, Cascade, Deerlodge, Flathead, Gallatin, Glacier, Granite, Jefferson, Lake, Lewis & Clark, Lincoln, Madison, Meagher, Mineral, Missoula, Pondera, Powell, Ravalli, Sanders, Silver Bow, Teton and Toole of the State of Montana.	808 Federal Office Building, Seattle, Wash.
No. 15	The States of Colorado, Utah and Wyoming; and the State of Montana except that part lying in District 14.	538 Customhouse, Denver, Colo.
No. 16	The States of North Dakota, South Dakota and Minnesota; the counties of Alger, Baraga, Chippewa, Delta, Dickinson, Gogebic, Houghton, Iron, Keweenaw, Luce, Mackinac, Marquette, Menominee, Ontonagon and Schoolcraft of the State of Michigan; and the State of Wisconsin except that part lying in District 18.	927 New P. O. Bldg., St. Paul, Minn.
No. 17	The States of Nebraska, Kansas and Missouri; and the State of Iowa except that part lying in District 18.	410 Federal Building, Kansas City, Mo.
No. 18	The States of Indiana and Illinois; the counties of Allamakee, Buchanan, Cedar, Clayton, Clinton, Delaware, Des Moines, Dubuque, Fayette, Henry, Jackson, Johnson, Jones, Lee, Linn, Louisa, Muscatine, Scott, Washington and Winneshiek of the State of Iowa; the counties of Columbia, Crawford, Dane, Dodge, Grant, Green, Iowa, Jefferson, Kenosha, Lafayette, Milwaukee, Ozukee, Racine, Richland, Rock, Sauk, Walworth, Washington and Waukesha of the State of Wisconsin.	2022 Engineering Building, Chicago, Ill.
No. 19	The State of Michigan except that part lying in District 16; the States of Ohio, Kentucky and West Virginia.	10th Floor, New Federal Bldg., Detroit, Mich.
No. 20	The State of New York except that part lying in District 2, and the State of Pennsylvania except that part lying in District 3.	514 Federal Building, Buffalo, N. Y.
No. 21	The Territory of Hawaii.	Aloha Tower, Honolulu, T. H.



# Index

	PAGE		PAGE
A.A.R.S.	6, 376	Break-In	358-359
A-I Operator Club	365	Bridge Circuits	42
AT-cut Crystals	146	Bridge Rectifiers	279-280, 287-288, 289
Abbreviations, Amateur	405-406	Broadcasting Stations, Official	14
Abbreviations, International Standard	389-393	Brute Force Filters	281
Abbreviations, Radio and Electrical	17, 399, 401	Bug Keys	15-16
Accelerator Grid	63	Buzzer Code Practice Set	12-13
Acorn Tubes	69		
Affiliation (A.R.R.L.)	388	C-L Ratios	145, 156
Alternating Current	21, 23	Calibrating Frequency Meter	330, 333-334
Amateur Bands	9-11	Call Areas	14
Amateur Operator's and Station Licenses	16	Canadian Regulations	16
Amateur Regulations	409-415	Canadian Traffic Agreement	371
Amateur Status	361	Capacitance	25-26
American Radio Relay League:		Capacitive Coupling	39, 158-159
Divisions	380-381	Capacitive Reactance	26-27
Foundation	2-3	Capacity-Resistance Time Constant	27-28
Headquarters	7	Carbon Microphones	223-225
Headquarters Station	8	Cathode Bias	169-170
Joining the League	7	Cathode Ray Oscilloscopes	340-341
Organization	8	Cathodes	64-65
Traditions	8	Characteristic Curves	51, 53-55
Ammeter	20	Characteristics of Vacuum Tubes (Tables)	70-86
Ampere	18	Charts and Tables:	
Ampere Turns	23	Abbreviations, Miscellaneous	392-393
Amplification Factor	52	Abbreviations for Electrical and Radio Terms	399-401
Amplification, Vacuum Tube	52-53	Amateur Wavelength-Frequency Bands	10
Amplifier Classifications	57-59	Antenna and Feeder Lengths	307, 310, 315, 317
Amplifiers (see "Receivers," "Transmitters" and "Radiotelephony")		Coil Specifications	174-175
Amplitude Modulation	46	Continental Code	10
Angle of Radiation	50, 320	Converter Circuit Tracking Values	101
Antenna Coupling (Transmitters)	170, 303, 301-302	DX Tables	398-399
Antenna Systems:		DX Time Chart	395-398
Angle of Radiation	50, 320	Decibel Chart	400
Antenna Impedance	303	Dielectric Constants	404
Broadside Antennas	324-326	Drill Sizes	401
Construction of	320-322, 327	Electrical Symbols	399
Directional Effects	319-320	Filter Choke Design	297
Directive Systems	323	Great Circle Distance Chart	397
Dummy Antennas	322-323	Greek Alphabet	405
Feed Systems:		Ham Abbreviations	405-406
General	300	High-Gain Voltage Amplifier Data	226
Current	306, 307-308	International Prefixes	393-394
Voltage	306	L-C Constants	36
Zepp	306-307	Modulator Data	226, 227
Center-Fed	303-304	Metric Prefixes	401
Concentric Lines	313-314	Preferred Receiving Tube Types	70
Doublet	311-312	Q Code	389-391
End-Fed	304-305	QSA-R System	14
Linear Transformers	314-315	R-S-T Scale	13
Multi-Band	316-317	Rectifier Tube Characteristics	81
Open Lines	315-316	Resistor Wattage Chart	403
"Q" Antenna	312-313	Schematic Symbols	37
Stub Matching	315	Shielding, Effect on Inductance	407
Transmission Lines	45, 306	Transformer Design	298
Twisted-Pair Feeders	311	Vacuum Tube Characteristics	70-86
Untuned Transmission Lines	308-309	Vacuum Tube Symbols	399
Grounded	270	WIINF-WIMK Schedules	14
Hertz	302-303	Wire Table	402
Marconi	300-302	Word List for Accurate Transmission	360
Masts	309-310	Checking Messages	368-369
Phased Antennas	323-324	Choke Design	299
Radiation Resistance	44, 303	Circuits, Receiving (see "Receivers")	
Receiving	322	Circuits, Transmitting (see "Transmitters")	
Rhombic or Diamond Antennas	326-327	Class A, B, and C Amplifiers	57-59
Theory	43, 44-47	Clickless Keying Methods	212-213
Tuning	308	Clubs	387-388
Ultra-High Frequency	327	Code (Continental) and Code Practice	11-13
V-Antennas	326	Code Practice Stations (for Beginners)	13
Army-Amateur Net	6, 376	Coefficient of Coupling	39
Attenuation	42	Colpitts Circuit	143
Audio Oscillator	12	Communications Department, A.R.R.L.	
Automatic Keys	15-16	Activities	379-380
Automatic Volume Control	107-108	Appointments:	
		Official Broadcasting Station	384
Band-Pass Filters	42	Official Observers	382-383
Band Spreading and Tuning Arrangements	90-91	Official Phone Station	384-385
Band-Switching	170-171	Official Relay Station	385-386
Bands, Amateur	9-11	Phone Activities Manager	383-384
Battery Bias	169	Route Manager	383
Beam-Power Tubes	68	Section Communications Manager	382
Beat Note Reception	47	Organization	380-381
Beat Oscillators	108-110	Communications Law	409-415
Beginner's Code Practice Stations	13	Complex Waves	29-30, 217-218
Bias	52-53, 143-144, 169-170	Condenser Breakdowns	404
Books Recommended	408-409	Condenser Series and Parallel Connections	27
Breadboard Construction	176	Condenser Reactance	26-27

# Index

	PAGE		PAGE
Condensers	25-26, 94-95	Five-Point System	378
Condensers, Electrolytic	26, 285	Fixed Condensers and Resistors	86
Condenser Capacitance (Computing)	403-404	Flux	23
Condenser Microphones	224, 225	Folded Resonant Line Circuits	45
Condensers, Energy Storage in	27	Foreign Traffic Restrictions	370-371
Conductors	19	Canadian Agreement	371
Contests	355-357	Formulas:	
Continental Code	11	A.C. Average and Effective Value	29
Controlled-Carrier Transmission	220-221, 237-238	Antenna Coupling (Doublet)	312
Converters, Frequency	98-101	Antenna Length	302, 311
Coulomb	22	Bridge Circuits	42
Counting Messages	375-376	Capacitive Reactance	27
Coupled Circuits	39	Capacity of Condenser	401-402
Coupling, Antenna	170, 300, 301-302	Cathode Bias	170
Coupling, Interstage	56, 157-161	Coefficient of Coupling	39
Critical Coupling	39-40	Combined A.C. and D.C. Currents	30
Crystal Filters	38-39, 104-105	Complex Wave	30
Crystal Microphones	224, 225	Critical Coupling	39
Crystal Oscillators	149-150	Decibel	399
Crystal-Control Transmitter Construction (see "Transmitters")		Energy Storage in Condensers	27
Crystals:		Impedance	28
Cuts	146-147	Impedance Matching	40
Grinding and Cutting	147	Inductance Calculation	401
Mounting	148-149	Inductive Reactance	25
Power Limitations	148	Input Choke	282
Temperature Effects	147-148	L-C Ratios	156
Current Feed for Antennas	307-308	Magnetic Circuit	23
Current Flow	18-19	Magnetic Energy Storage	25
Current in A.C. Circuits	23	Modulation Percentage	217
Current Lag	30-31	Multipliers (Meter)	335
Cycle	21	Ohmmeter (from voltmeter)	336
DX Tables	398-399	Ohms Law (A.C.)	28
DX Time Chart	395-398	Ohms Law (D.C.)	22
Damping	35	On Oscilloscope	239
Decibel	399	Parallel Resonant Circuit Impedance	38
Delivering Messages	374-375	Plate Modulation Conditions	222
Demodulation	46, 61-62	Power	22-23, 30, 40
Detection	46, 61-62	Power Factor	31
Dielectrics and Dielectric Constants	25, 404	Power Output	55
Diode	51	Q	37
Direct Coupling	39	R.F. Resistance	37
Direct Current	21	Radiation	45
Direction of Current Flow	18-19	Reactance	25, 27
Directional Antennas (see "Antenna Systems")		Resonance	35, 283
Distance Measurement	397	Resonant Line Spacing	264
Distortion	53, 55, 59-60	Ripple	282, 284
Distributed Inductance, Capacitance and Resistance	28	Series, Parallel and Series-Parallel Capacities	27
Districts, Inspection	416	Series, Parallel and Series-Parallel Inductances	24
Doublet Antennas	278	Series, Parallel and Series-Parallel Resistances	22
Doubling Frequency in a Transmitter	167-169	Shielding, Effect on Inductance	406-408
Drill Sizes	401	Sine Curve	29
Dummy Antennas	322-323	Surge Impedance	309
Dynamic Characteristics	54	Time Constant	28
Effective Value (A.C. Sine Wave)	29	Transformer Voltage	283, 296
Efficiency, Amplifier	154-156	Transmission Line Spacing	313
Electrical Interference Reduction	110	Turns Ratio	40
Electrical Units and Symbols	399	Voltage Dividers	293
Electricity	18	Voltage Regulation	280
Electrolytic Condensers	26, 285	Wavelength-Frequency Conversion	43
Electromagnetism	23-24	Frequencies, Amateur	10
Electromotive Force (E.M.F.)	20	Frequencies for Best Operation	9-11
Electron Flow	18	Frequency	21, 43-44
Electron-Coupled Circuit	143	Frequency Converters	98-101
Electron-Coupled Frequency Meters	331-333	Frequency-Inductance-Capacity Calculation	44
Electron-Ray Tubes	68	Frequency-Wavelength Conversion	43
Electronic Relay	347	Frequency Meters:	
Emergency Work	361-363	Absorption Frequency Meters	329-330
Emission, Electron	20	Combined Frequency Meter-Monitor	293-294, 332-333
Energy Storage in Condensers	27	Electron-Coupled Frequency Meter	331-332
Excitation	154	Frequency Meter Calibration	320, 333-334
Exciter Units (see "Transmitters")		Frequency Modulation	218
Exhibition and Fair Stations	372	Frequency Multipliers	167-169
Fading	50	Fringe Howl	124-125
Farad	26	Full-Wave Rectifiers	276-277
Feed-Back	62	Fundamental Frequency	29-30
Feeders and Feed Systems (see "Antenna Systems")		Gas, Conduction in	19-20
Fidelity	87, 90	Generators	275-276
Field-Strength Meters	339-340	Generators, Radio Frequency	60-61
Filament Supply	286-287	Greek Alphabet	405
Fills and Repeats	374-375	Grid	52
Filter Circuits	41-42	Grid Bias	52-53, 143-144, 169-170, 289-291
Filter, Crystal	38-39, 87	Grid-Bias Modulation	219-220, 239-240
Filters (see "Power Supply")		Grid Detection	61-62
Five Meters (see "Ultra High Frequencies")		Grid Excitation	154
		Grid Leak Bias	143-144, 169
		Grid Neutralization	162-163
		Grid Voltage-Plate Current	53-54
		Grinding Crystals	147
		Grounds	143, 180-181

# Index

	PAGE		PAGE
Half-Wave Rectifiers	276	Locating the Station	342-343
Harmonic Generation	151-152, 167-169	Log Books	359-360
Harmonic Operation of Antennas	44	Low-Pass Filters	42, 317-318
Harmonic Suppression	156	Low-Power Transmitters (see "Transmitters")	
Harmonics	29-30, 55, 59-60	Magnet	24
Hartley Circuit	142	Magnetic Energy Storage	25
Heat in D.C. Circuits	22	Magnetism	23-24
Henry	24	Magnetomotive Force	23
Hertz Antenna	302-303	Manual, License	16
Heterodyne Reception	47	Marconi Antenna	300-302
Heterotone Reception	109-110	Masts	349-350
High-Pass Filters	42	Measurements:	
History of Amateur Radio	1-6	Distance	397
Image Suppression	96-98	Frequency	329-334
Impedance	28-29	(see also "Instruments")	
Impedance Coupling	56	Megacycle	21
Impedance Matching	40	Memorizing the Code	11-12
Incident Waves	43	Mercury Vapor Rectifiers	277-279
Inductance	24	Message Form	366-367
Inductance Calculation	401	Messages, "Rubber Stamp"	377
Inductances in Series and Parallel	24	Metal Chassis Construction	176
Inductive Coupling	39, 159-160	Meters (see "Instruments")	
Inductive Reactance	25	Metric Prefixes	401
Inspection Districts	416	Microfarad	26
Instruments:		Micromhos	52
Cathode-Ray Oscilloscopes	340-341	Microphones	223-225
Field-Strength Meters	339-340	Milliammeters	334-336
Frequency Meters	329-333	Milliamperes	23
Milliameters	334-335, 336	Mixers	96, 101-108
Ohmmeters	335-336	Modulation	45-47, 216-218
Vacuum-Tube Voltmeters	338-339	Modulation Capability	218
Voltmeters	20, 334-336	Modulation Methods	195-197, 218-221
Insulators	19	Modulation Percentage	217
Insurance Rating Bureaus	348	Monitors	328-329, 332-333, 334
Interelectrode Capacitances	65	Mounting Crystals	148-149
Interference Committees	364-365	Mu	52
Interference, Elimination of:		Multi-Band Antenna	316-317
Blanketing	213	Multi-Purpose Meter	336
Electrical Noise	110-113	Multipliers, Frequency	167-169
R.F. Filters	211-212	Mutual Conductance	52
Radiotelephone Interference	215-216	Mutual Inductance	39
Re Broadcast Receivers	215, 364-365	N.C.R.	6, 376
Rectifier Noise	214-215	Navy-Amateur Net	6, 376
Superheterodyne Harmonics	214	Negative and Positive Terminals	18-19
Wavetraps	213	Neutralizing	42, 153, 161-165, 173
(See also "Keying")		Nodes	44
Intermediate Frequency Amplifiers	102-103, 106-107	Noise-silencing	111-113
International Amateur Radio Union	4-5, 7-8	Numbering Messages	367-368
International Prefixes	393-394	Official Broadcasting Stations	14, 384
Interruption Frequency	62, 244-245	Official Observers	382-383
Interstage Coupling	56, 157-161	Official Phone Stations	384-385
Ionization	19-20	Official Relay Stations	385-386
Ionsphere	49-50	Ohm	21
Joule	22	Ohm's Law	21-22
Key Clicks	210	Ohm's Law for A.C.	28
Key, How to Grip	14-15	Ohmmeters	335-336
Keying:		Operating Notes	351-353, 357-358, 365
Design Considerations	208-209	Operating Position	343-345
Key-Click Elimination	210-213	Operating Procedure	353-355
Keyer Tubes	211	Operator's License	13
Keying Chirps	209	Originating Traffic	371-372
Methods:		Troubles to Avoid	373
Center-Tap	206-207	Oscillation Frequency	35
Grid	206, 208	Oscillators	12, 60-61, 101-102, 141-143, 146, 149-150, 259-262
Plate	205-206	Oscilloscopes	340-341
Screen Grid	207	Overmodulation Indicators	241
Suppressor Grid	207-208	Parallel Capacities	27
Parasitic Clicks	211	Parallel Feed	144
(See also "Interference Elimination")		Parallel Inductances	24
Kilocycle	21	Parallel Resistances	22
L-C Constants	35-36	Parallel Resonance	36
L-C Ratios	145, 156	Parasitic Oscillations	172-173
Land Line Check	368-369	Pentagrid Converters	99-101
Laws Concerning Amateur Operation	409-415	Pentode Crystal Oscillators	149-150, 150-151
Layer Height	49-50	Pentodes	62-63
Lead and Lag	31	Permanent Magnets	24
Lecher Wires	259	Permeability	23-24
License Manual	16	Phase	30-31
Licenses, Amateur	16	Phased Antennas	323-324
Lightning Arresters	348-349	Phone (see "Radiotelephony")	
Linear Amplifiers	58, 220	Phone Activities Manager	383-384
Linear Antenna Transformers	314-315	Photoelectric Emission	20
Linear Oscillators	261-262	Pi-Section Filters	42
Link Coupling	41, 160-161	Piezo-Electric Crystal Circuit	38-39
Liquids, Conduction in	19	Piezo-Electric Microphone	224, 225
Load Impedance	40, 54, 153-154		

# Index

	PAGE		PAGE
Plate Current	51	Grid-Bias Modulation	219-220, 239-240
Plate Detection	61	Interference	215-216
Plate Family	54-55	Microphones	223-225
Plate Modulation	221-223, 238-239	Modulation and Modulation Methods	216-221
Plate Neutralization	162-163	Modulation Capability	218
Plate Resistance	52	Modulator-Amplifier Combinations	229-236
Plate Transformer Design	283, 295-299	Modulator Construction	229
Polarization	47-48	Modulator Tube Calculations	221-223
Portable Power Supplies	293-294	Monitors	334
Positive and Negative Terminals	18-19	Official 'Phone Station Appointment	384-385
Power	22-23, 30, 40	Overmodulation Indicators	241
Power Factor	31	Percentage Modulation	217
Power Line R.F. Filters	211-212	'Phone Activities Managers	383-384
Power Output	55	Plate Modulation	221-223, 238-239
Power Supply:		Plate Modulation of Pentodes	236-237
Bias Supplies	169, 289-291	Procedure	360
Choke Design	282, 299	Remote Control	345-348
Duplex Plate Supply	289	Speech Amplifier Design	226
Electrolytic Condensers	285	Suppressor-Grid Modulation	218, 220, 240-241
Filament Supply	286-287	Word List	360
Filters	280-283, 283-286	Reactance, Capacitive	26-27
Design	41-42, 281-283, 283-284	Reactance, Inductive	25
Filter Chokes	284-285, 299	Receivers:	
Filter Condensers	285-286	Antennas for	322
Input Choke	282-283	Audio Frequency Amplifiers	94
Line Voltage Regulation	294-295	Audio Limiter Circuits	112-113
Portable and Independent Power Supplies	293-294	Automatic Volume Control	107-108
Practical Power Supplies	287-289	Band Spreading	90-91
Receiver Power Supplies	291-292	Beat Oscillators	108-110
Rectifier Circuits	276-277, 279-280	Circuit Constants	91
Rectifiers	81, 277	Class-C Audio Amplifier	113
Regulation	280, 294-295	Construction:	
Series Connection of Transformers and Rectifiers	289	Balanced T.R.F. Receiver	125-126
Transformer Design and Construction	283, 295-299	High-Performance Superheterodyne	131-136
Tube Limits	277-278	Noise-Silencer and Crystal Filter	136-139
Voltage Dividers	292-295	Regenerative Single-Signal Superhet	126-131
Practical Problems:		Tuned R.F. Receiver	122-125
Coils	32-33	Two-Tube Pentode Receiver	119-121
Complex Waves	33	Two-Tube Triode Receiver	116-119
Condensers	33	Electrical Noise Reduction	110
Ohm's Law	32	Frequency Converter Circuits	98-101
Prefixes, International	393-394	Heterotone Modulation	109-110
Prefixes, Metric	401	Input Circuits	96-98
Pre-Selection	96-98	Intermediate Frequency Amplifiers	102-103
Pulling	99, 101	Judging Receiver Performance	140
Pulsating Currents	37	Noise Silencing	111-112
Push-Pull Amplifiers	60	Oscillator Stability and Tracking	101-102
Push-Pull Oscillators	146	Power Supply	291-292
Q	36-102	Quartz Crystal I.F. Filters	104-105
Q Antennas	312-313	R.F. Amplifiers	93
Q Code	389-391	Regenerative Detector Circuits	87, 91-93
QRR	361-362	Regenerative I.F. Amplifiers	106-107
QSA System	364	Second Detectors	107-108
QSL Managers	405	Servicing Receivers	139-140
QST	8	Shielding	93-94
Quartz Crystals	38-39, 104-105, 146-149	Single-Signal Selectivity	103-104
Quench Frequency	62, 244-245	Speaker Output Stage	122
R.M.S.	29	Superheterodyne Receivers	87, 96
R-S-T System	363-364	Test Oscillators	336-338
Rack Construction	176-179	Tuning Systems	90-91
Radiation	44-45	Types	87
Radiation Angle	50, 320	Ultra High Frequency (see "Ultra High Frequencies")	
Radiation Resistance	44, 303	Variable Selectivity	103, 105-106
Radiator (see "Antennas")		Volume Control	94
Radio Frequency Chokes	43	Rectification	51, 61
Radio Frequency Generators	60-61	Rectifier-Filter Systems (see "Power Supply")	
Radio Frequency Resistance	37	Rectifiers	69, 81
Radio Inspection Districts	416	Reflected Waves	46
Radiotelephony:		Reflection of Radio Waves	47-48
18-Watt General Purpose Unit	230-231	Regenerative Detectors	62, 91-93
20-Watt "Economy" Modulator	233-235	Regulation, Voltage	280, 294-295
50-Watt 6L6 Modulator	231-232	Regulations, Amateur	411-415
100-Watt All Push-Pull Modulator	235	Regulations, Canadian	16
250-Watt High-Gain Class-B Unit	235-236	Relay Procedure	373-374
500-Watt Class-B Modulator	236	Relay Racks	177-179
Adjustment	238-241	Reluctance	23
Amplifiers:		Remote Control	345-348
Class A	57, 219	Reporting Traffic	377-378
Class B (Modulator)	58-59, 219	Resistance	21
Class B (Linear R.F. Amplifier)	58, 220	Resistance-Capacity Time Constant	27-28
Class C	59, 221-223	Resistance Coupling	56
Amplitude and Power Relations	217-218	Resistance, R.F.	37
Controlled Carrier Transmission	220-221	Resistances in Series	22
Design Considerations	228-229	Resistive Coupling	39
Economy Class B Modulation	223	Resistors	22, 95-96
Electronic Relay	347	Resonance	35, 44
Frequencies and Regulations	9-11, 409-415	Resonant Circuit Impedance	37-38
		Resonant Line Circuits	45
		Ribbon Microphones	224, 225

# Index

	PAGE		PAGE
Ripple	280	Circuit Values	157
Route Manager	383	Coils	173-175, 179-180
Root Mean Square Value	29	Colpitts Circuit	143
Rubber Stamp Messages	377	Construction:	
Saturation Point	52	100-Watt Transmitter	196-199
Schedules	378	Five-Band Two-Tube Exciter	185-188
Schematic Diagrams	32	Four-Band 47-46-10 Transmitter	183-185
Screen Grid	63	General Purpose 50-Watt Transmitter	192-196
Screen Grid Amplifiers (Transmitting)	166-167	Antenna Tuning Unit	196
Second Detectors	107-108	High-Power Amplifier	203-204
Secondary Emission	63	Low-Power Crystal Transmitter	182-183
Section Communications Manager	382	Medium-Power Amplifier	199-200
Selective Fading	50	Push-Pull 250-Watt Amplifier	201-203
Selectivity	87, 88-89	Push-Pull Band-Switching Amplifier	200-201
Self-Inductance	24	R-K-20 Tri-Tet Oscillator	188-191
Sending	15	Two-Stage Pentode Transmitter	191-192
Sensitivity	87, 89	Crystal Control	146
Series Capacities	27	Crystals, Cutting and Grinding	146-147
Series Feed	144	Crystals, Mounting	148-149
Series Inductances	24	Efficiency	154-156
Series Power Supplies	289	Electron-Coupled Circuit	143
Series Resistances	22	Excitation	154
Series Resonance	36	Frequency Multipliers	167-169
Service Message	375	Frequency Stability	144-145
Servicing Receivers	93-94	Grid Bias	143-144, 169-170
Shielding	93-94, 229	Grid Neutralization	162-163
Short Wave Receivers (see "Receivers")		Grounds	143, 180-181
Show Stations	372	Harmonic Generation	151-152, 167-168
Side Bands	46-47	Harmonic Suppression	151
Signal Generators	336-338	Hartley Circuit	142
Signal Strength Scale	363-364	High-C	145
Sine Wave	29	Interstage Coupling	157-161
Single-Signal	103-104	L-C Ratios	145, 156
Skin Effect	37	Layout	180
Skip Distance	49	Link Coupling	160-161
Socket Connections	65, 66, 67, 68, 69	Load Impedance	153-154
Soldering	115	Metal-Chassis Construction	176
Space Charge	20, 51-52	Neutralizing	42, 153, 161-165, 173
Speech Amplifiers	226	Oscillator Circuits	141-143
Speech Input Circuits	223-225	Parallel Feed	144
Stability, Receiver	87, 89-90	Parallel Operation	156-157
Stability, Transmitter	144-145	Parasitic Oscillations	172-173
Standard Frequency System	333-334	Pentode Crystal Oscillators	149-150, 150-151
Standing Waves	43	'Phone (see "Radiotelephony")	
Static Characteristics	53-54	Plate Neutralization	162-163
Station Arrangement	342-345	Power Amplifiers	153-157
Station License	16	Power Supply (see "Power Supply")	
Status, Amateur	361	Push-Pull Operation	146, 150, 156-157
Storage Batteries	275-276	Rack Construction	176-179
Stub Antenna Matching	315	Screen-Grid Amplifiers	166-167
Superheterodyne Receivers (see "Receivers")		Self-Controlled Oscillator Circuits	141-143
Superinfragrator Receiver	257	Series Feed	144
Superregeneration	62	T.N.T. Circuit	143
Superregenerative Receiver	244-245	Triode Crystal Oscillators	149, 150-151
Suppressor Grid	63	Tri-Tet Circuit	151-153
Suppressor Grid Modulation	218, 220, 240-241	Trouble-Shooting	171-172
Surge Impedance	45	Tubes	69-70, 141
Symbols, Electrical	17, 399	Tubes (Table of Characteristics)	82-86
Synthesis Wave	46	Tuned Grid-Tuned Plate Circuit	142-143
T.O.M. (The Old Man)	8	Tuning	151, 165-167
Tables and Charts (see "Charts and Tables")		Ultra-High Frequency (see "Ultra-High Frequency")	
Tap Sizes	401	Ultraudion Circuit	143
Tape Transmission	14	Unity-Coupled Circuit	146
Tapped Circuits	40-41	Triode	52
Test Oscillators	336-338	Triode Crystal Oscillators	149, 150-151
Tetrodes	62-63	Tri-Tet Exciter	151-153
Thermionic Emission	20	Trouble Shooting (Receivers)	139-140
Throttle Condenser Regeneration Control	83	Trouble Shooting (Transmitters)	171-172
Thump Filters	210-213	Trunk Lines	387
Time Chart	395-398	Tubes (see "Vacuum Tubes")	
Time Constant	27-28	Tuned Circuit Impedance	37-38
Tools	114-115	Tuned Circuits	34-35
Tracing Messages	372	Tuned Grid-Tuned Plate Circuit	142-143
Tracking	101-102	Tuning Arrangements and Band-Spreading	90-91
Traffic Restrictions, Foreign	370-371	Twisted Pair Feeders	311
Canadian Agreement	371	Ultra-High Frequencies:	
Transceivers	274	Antenna Systems	257, 327
Transformer Coupling	56	Directive Arrays	327
Transformer Design and Construction	283, 295-299	General Considerations	50, 242-244, 258-259
Transformers	24-25	Receivers:	
Transmission Line Coupling	41, 160-161	Acorn-Tube Receiver	246-247
Transmission Lines	45, 306	Metal-Tube Receiver	249-251
Transmitters:		R.F. Amplifiers	251-253
Antenna Coupling	170, 300, 301-302	Self-Quenched	245-246
Band-Switching	170-171	Separately Quenched Receivers	247-249, 251
Bias Supplies	169	Superheterodyne	253-257
Blocking and By-Pass Condensers	142	Superinfragrator Receiver	257
Breadboard Construction	176	Transceivers	274

# Index

	PAGE		PAGE
Transmitters:		Tables:	
Concentric-Line Transmitters	266-268	Receiving (Glass)	71-75, 77-80
Crystal-Controlled Transmitters	271-274	Receiving (Metal)	75-76
Filament Circuits	268	Rectifiers	81
Linear Oscillators	261-262	Transmitting	69-70, 82-86
Modulators	274	Tetrodes	63
Open-Line Transmitters	264-266	Transmitting	141
Oscillator-Amplifier Transmitters	268-271	Variable- $\mu$ Tubes	64
Resonant Lines	263-265	Variable Selectivity	103, 105-106
Short-Line Control	262-263	Velocity Microphone	224, 225
Simple Oscillators	259-261	Velocity of Radio Waves	43
Three-Band Transmitter	262	Volt	20
Ultraudion Circuit	143	Voltage Amplification	56-57
Underwriters Rules	348	Voltage Dividers	292-295
Using a Key	14-15	Voltage Feed for Antennas	306
V-Cut Crystals	146	Voltage Regulation of Rectifiers	280, 294-295
Vacuum Tube Voltmeters	338-339	Voltmeters	20, 334-336, 338-339
Vacuum Tubes:		Volume Control	94
Beam-Power Tubes	68	Volunteer Code Practice Stations (for Beginners)	13
Cathodes	64-65	W1INF/W1MK, A.R.R.L. Hq. Station (frontispiece)	8
Characteristic Curves	51, 53-55	Broadcasting Schedule	14
Electron-Ray Tubes	68	WAC Certificates	4, 8, 387
General	51-52	WAS Certificates	387
Multi-Purpose Tubes	63-64	Watt	22
Numbering	65-66	Wavelength	43-44
Operation:		Wavelength-Frequency Conversion	43
As Amplifiers	52-60	Wavelength Performance	9-11
Class A	57	Wavelengths, Amateur	10
Class B	58-59	Wavemeter (see "Frequency Meters and Monitors")	
Class C	59	Wave Traps	213
As Detectors	61-63	Wire Table	402
As Oscillators	60-61	Wiring	115-116
Pentodes	63	Word Lists for Accurate Transmission	340
Preferred Receiving Types	67-68, 70	Wouff-Hong	8
Ratings and Characteristics	65	X-Cut Crystals	146
Rectifiers	69, 81	Y-Cut Crystals	146
Socket Connections	65, 66, 67, 68, 69	Zeppelin Feed for Antennas	306-307
Space Charge	51-52		
Special Types	68-69		
Symbols	399		

# To Handbook Readers Who Are Not A.R.R.L. Members

## AMATEUR RADIO OF TODAY IS THE RESULT OF THE EFFORTS OF A.R.R.L.

### For More Than Twenty Years

the A.R.R.L. has been the organized body of amateur radio, its representative in this country and abroad, its champion against attack by foreign government and American commercial, its leader in technical progress.

### To:

Save yourself 50c a year (newsstand copies of *QST* cost \$3).

Be sure of getting your copy of *QST* first.

Be sure of getting your copy of *QST* (newsstands are often sold out).

Be eligible for appointment or election to A.R.R.L. offices.

Be eligible to sign petitions for your Director, your representative on the A.R.R.L. Board.

Be eligible to vote for Director and Section Comm. Manager (only A.R.R.L. members receive ballots).

Lend the strength of your support to the organization which represents YOU at Cairo, at Washington — at all important radio conferences.

Have YOUR part in the A.R.R.L., which has at heart the welfare of all amateurs.

## JOIN THE LEAGUE!

### AMERICAN RADIO RELAY LEAGUE

West Hartford, Conn., U. S. A.

I hereby apply for membership in the American Radio Relay League, and enclose \$2.50 (\$3.00 outside of the United States and its Possessions, and Canada) in payment of one year's dues, \$1.25 of which is for a subscription to *QST* for the same period. Please begin my subscription with the..... issue. Mail my Certificate of Membership and send *QST* to the following:

Name .....

Street or Box .....

City and State .....

### To Handbook Readers Who Are Already A.R.R.L. Members:

FOR members who hold amateur licenses, who are interested in radio activities and Communications Department operating work (explained fully, Chap. XIX, XX, XXI), here is an application blank which may be filled out for appointment as either Official Relay Station (for telegraphing members) or Official Phone Station (for voice operated member-stations). Copy this, or cut and fill it out, and send it direct to your Section Communications Manager (address in QST) or to A.R.R.L. Headquarters, 38 LaSalle Road, West Hartford, Conn. for routing to the proper S.C.M. for attention if you are interested.

The Communications Department field organization includes only the United States and its territories, and Canada, Newfoundland, Labrador, Cuba, the Isle of Pines, and the Philippine Islands. Foreign applications, that is, those from outside these areas, cannot be handled.

### APPLICATION FOR APPOINTMENT AS OFFICIAL.....STATION (Relay or Phone?)

To: Section Communications Manager..... Section, A.R.R.L.

Name..... Call.....

Street and Number..... Date.....

City..... State..... County.....

Transmitting frequencies specified on my license from..... kilocycles

to..... kilocycles. Actual frequency in use..... kilocycles.

My membership in the A.R.R.L. expires.....  
month year



In making application for appointment as Official Relay Station, I agree:

- to obey the radio communication laws and regulations of the country under which this station is licensed, particularly with respect to quiet hours and observance of our frequency allocations.
- to send monthly reports of station activities to the Section Communications Manager under whose jurisdiction this station comes.
- to handle messages in accordance with good operating procedure, delivering messages within forth-eight (48) hours when possible, mailing to destination whenever impossible to relay to the next station in line within a 48-hour period.
- to participate in every A.R.R.L. communication activity to the best of my ability, always trying to live up to those ideals set forth in "The Amateur's Code."

In making application for appointment as Official Phone Station, I agree:

- to obey the radio communication laws of the country under which my station is licensed, particularly with respect to the regulations governing quiet hours and frequencies.
- to send monthly reports of station activities to the Section Communications Manager under whose jurisdiction this station comes; to use such operating procedure as may be adopted by the O.P.S. group; to test outside busy operating hours or using dummy antennas.
- to handle such messages as may come to me, as accurately, promptly and reliably as possible.
- to participate in all amateur communication activities to the best of my ability, always trying to live up to those ideals set forth in "The Amateur's Code" and to carry on amateur operation in a constructive and unselfish spirit.
- to use circuits and adjustments that avoid frequency modulation and over modulation by proper transmitter adjustment (accomplished by use of proper indicating devices) to avoid causing interference unnecessarily.

*I understand that this appointment requires annual endorsement, and also may be suspended or cancelled at the discretion of the Section Communications Manager for violation of the agreement set forth above*

Please send detailed forms to submit to my S.C.M. in connection with this application.

Signed.....





# The Catalog Section



In the following pages is a catalog-file of products of the principal manufacturers who serve the short-wave field. Appearance in these pages is by invitation—space has been sold only to those dependable firms whose established integrity and whose products have met with the approval of the American Radio Relay League.



# Index of Manufacturers

## ★ CATALOG SECTION ★

### THE RADIO AMATEUR'S HANDBOOK



	<i>Page</i>		<i>Page</i>
Aerovox Corporation . . . . .	462	International Resistance Company . . . . .	513
Aladdin Radio Industries, Inc. . . . .	447-454	Jefferson Electric Company . . . . .	523
American Radio Relay League, Inc. . . . .	525-535	Johnson Company, E. F. . . . .	505-507
Astatic Microphone Laboratory, Inc. . . . .	468	Kenyon Transformer Company . . . . .	520
Birnbach Radio Company . . . . .	476	Manhattan Electric Bargain House . . . . .	470-472
Bliley Electric Company . . . . .	510-511	McElroy, T. R. . . . .	486-487
Bruno — New York, Inc. . . . .	480	McGraw-Hill Book Company . . . . .	494
Candler System Company . . . . .	478	Meissner Manufacturing Company . . . . .	492-493
Cardwell Mfg. Corporation, Allen D. 484-485	484-485	Mueller Electric Company . . . . .	504
Continental Carbon Company . . . . .	516	National Carbon Company . . . . .	488-489
Cornell Dubilier Corporation . . . . .	474-475	National Company, Inc. . . . .	427-446
Corning Glass Works . . . . .	473	Ohmite Manufacturing Company . . . . .	518-519
Coto-Coil Company, Inc. . . . .	517	Par Metal Products Corporation . . . . .	481
Crescent Insulated Wire & Cable Co., Inc. . . . .	508	Radio Mfg. Engineers . . . . .	503
Eitel-McCullough, Inc. . . . .	477	Radio Transceiver Laboratories . . . . .	509
Electric Soldering Iron Company, Inc. . . . .	479	Raytheon Production Corporation . . . . .	455
General Electric Company . . . . .	456	RCA Manufacturing Company . . . . .	514-515
General Radio Company . . . . .	491	Sangamo Electric Company . . . . .	502
Gordon Specialties Company . . . . .	512	Shure Brothers Company . . . . .	521
Gross Radio, Inc. . . . .	495	Sprague Specialties Company . . . . .	522
Hallicrafters, Inc. . . . .	464-467	Struthers-Dunn Company . . . . .	490
Hammarlund Manufacturing Co. . . . .	457-461	Taylor Tubes, Inc. . . . .	496-497
Harvey Radio Laboratories, Inc. . . . .	483	Teleplex Company . . . . .	501
Heintz & Kaufman . . . . .	524	Thordarson Electric Mfg. Company . . . . .	463
Instructograph Company . . . . .	482	Triplet Electrical Instrument Company . . . . .	469
		United Transformer Corporation . . . . .	498-499
		Western Electric Company . . . . .	500

# NATIONAL

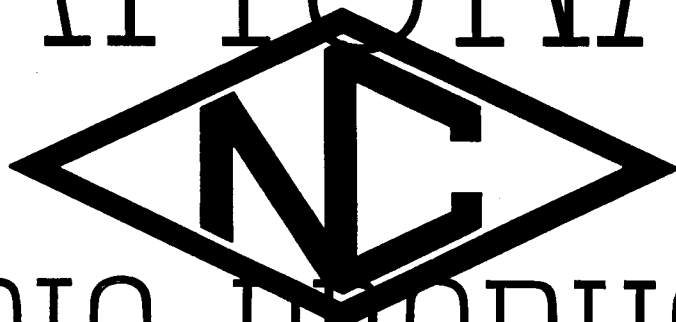

# RADIO PRODUCTS

DESCRIPTIVE  
PRICE LIST

BULLETIN  
**260**

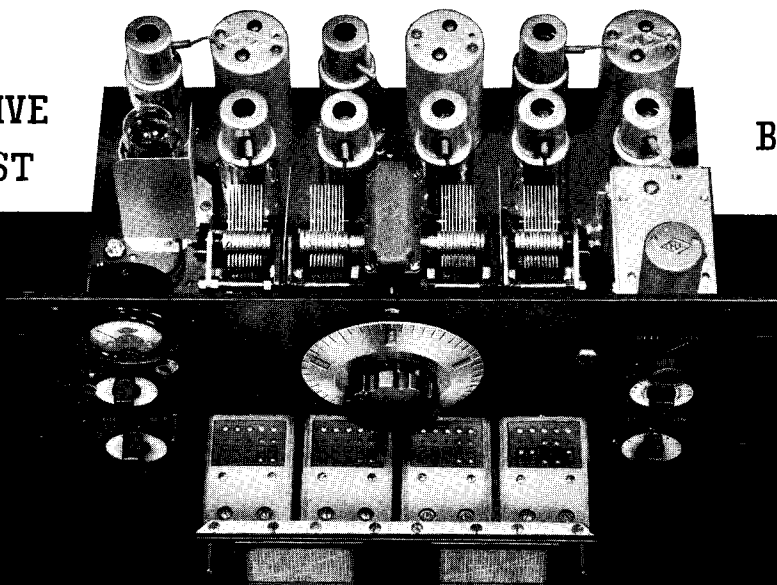

# NATIONAL *Ganged* CONDENSER

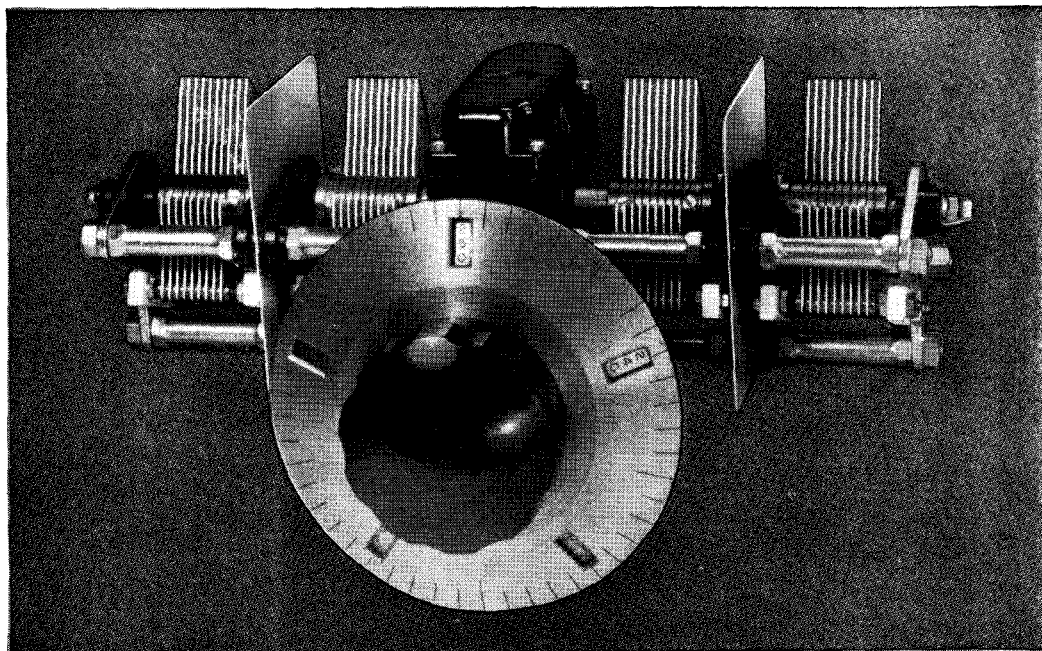

## PRECISION GANGED CONDENSER

The PW Precision Condenser has been particularly designed for use in H.F. circuits. It is available with 2, 3 or 4 ganged sections for use in receivers, and in a new single section model for use in laboratory equipment. The sizes available are listed at the right.

The condenser is of extremely rigid construction, with four bearings on the rotor shaft. The drive, at the midpoint of the rotor, is through an enclosed pre-loaded worm gear with 20 to 1 ratio. Each rotor is individually insulated from the frame, and each has its own individual rotor contact, of the multi-fingered brush type. Stator insulation is Steatite.

The Micrometer dial is of a new type and reads direct to one part in 500. Division lines are approximately  $\frac{1}{4}$ " apart. As is evident from the illustration above, the dial is read in the usual way. However, the dial revolves ten times in covering the tuning range, and the numbers visible through the small windows change every revolution to give consecutive numbering by tens from 0 to 500. As the illustration shows, the numbers rotate with the division lines at the top of the dial, and change rapidly at bottom of the dial where they are out of the operator's line of sight. As the dial has only two moving parts, both rotating, the dial is very smooth in operation and does not interfere with delicate tuning adjustment.

The dial and enclosed worm drive is listed separately, for use in driving transmitting condensers and similar equipment.

## SPECIFICATIONS

PW Ganged Condensers are available in 2, 3 or 4 sections, in either 160 or 225 mmf per section. Larger capacities cannot be supplied. The single-section PW condenser is supplied in capacities of 150, 200, 350 and 500 mmf, single spaced. Capacities up to 125 mmf can be supplied double spaced. The rotor is not insulated on the single section model.

Plate shape is straight-line-frequency when the frequency range is 2:1.

### Single Section

**PW-1 List Price \$13.50**

### Two Section

**PW-2 List Price \$17.00**

### Three Section

**PW-3 List Price \$20.50**

### Four Section

**PW-4 List Price \$24.00**

### Drive Unit with TX-9 Coupling

**PW-0 List Price \$13.50**

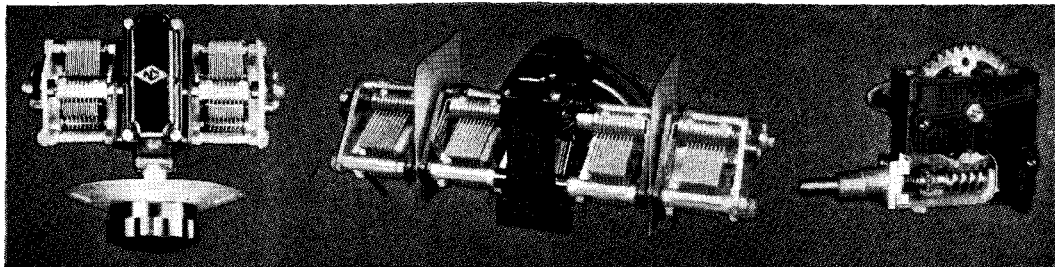

**NATIONAL COMPANY, INC., MALDEN, MASS.**

# NATIONAL DIALS

## "HRO" & "O" DIALS

FIGS. 1a & 1b

The 1 9/16" dia. HRO dial (Fig. 1a) is etched nickel silver and fits 1/4" shafts. Reads from 0 to 10 over 180°, numbers increasing with clockwise rotation.

List Price, each \$ .75

The insulated 3 1/2" dia. O dial (Fig. 1b) is circular-grained German Silver and fits 1/4" shafts. Available with 2 scale.

List Price, each \$1.50

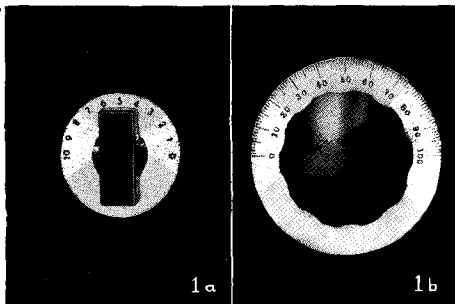

## "N" & "NW" DIALS

FIGS. 2 & 3

Precision Dials, Type N, have engine divided scales and verniers of solid German Silver. The Verniers are flush, eliminating errors from parallax.

The four-inch Type N dial (Fig. 3) employs a smooth and powerful planetary mechanism with a 5 to 1 ratio. It is available with either 2, 3, 4 or 5 scale.

List Price, each \$6.75

The six-inch Type NW dial (Fig. 2) has a variable ratio drive that is unusually powerful at all settings. It is recommended for use on large transmitters and precision instruments. Available with either 2, 3, 4 or 5 scale.

List Price, each \$15.00

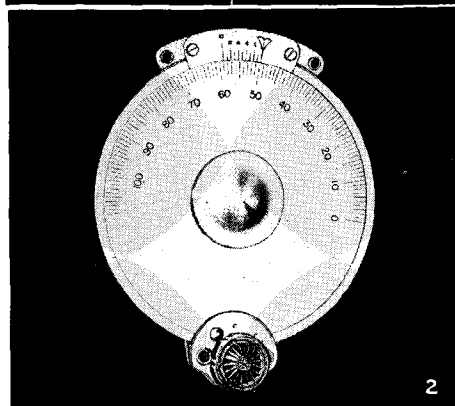

## "A" DIAL

FIG. 4

The original "Velvet Vernier" Dial, Type A, is still an unchallenged favorite for general purpose use. It is exceptionally smooth and entirely free from backlash. The mechanism is contained within the bakelite knob and shell. Ratio 5 to 1. Available with either 2, 4 or 5 scale in 4" diameter. Available with 2 scale in 3 3/8" diameter.

List Price, each \$3.00

## "B", "BM", & "BX" DIALS

FIGS. 5, 6, 7

"Velvet Vernier" Dial, Type B (Fig. 7) provides a compact variable-ratio drive that is smooth and trouble free. The mechanism is inclosed in a black bakelite case, the dial being read through a window. Available with 1 or 5 scales.

List Price, each \$2.75

If illuminator is desired, add \$.50 to List Price.

The Type BX Dial (Fig. 6) is mechanically identical to the Type B Dial, but is equipped with an etched dial scale and vernier reading to 1/10 division. Available with 4 scale only.

List Price, each \$3.50

The Type BM Dial (Fig. 5) is a smaller version of the Type B Dial for use where space is limited. It is similar to the Type B Dial in appearance and mechanism, but does not have the variable-ratio device. Available with 1 or 5 scales.

List Price, each \$2.50

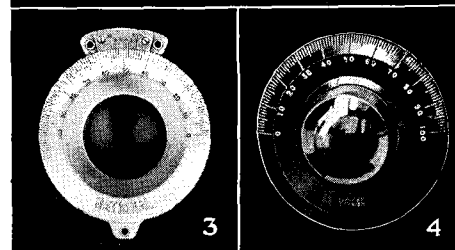

## "H" DIAL

FIG. 8

Projection Drum Dial, Type H, employs the proved and popular non-conducting cord drive with spring take-up. The dial scale is optically projected in illuminated figures on a ground-glass screen, considerably enlarged. Parallax is entirely absent. Condenser shaft must be parallel to panel. Available with either 2, 3 or 4 scale.

List Price, each \$5.50

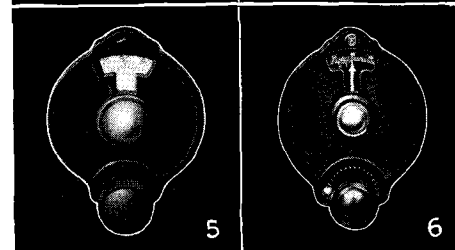

### DIAL SCALES

Scale Type	Divisions	Degrees Rotation	Direction of Condenser Rotation for increase of dial reading
1	0-100-0	180°	Either
2	0-100	180°	Counter Clockwise
3	100-0	180°	Clockwise
4	150-0	270°	Clockwise
5	200-0	360°	Clockwise
6	0-150	270°	Counter Clockwise

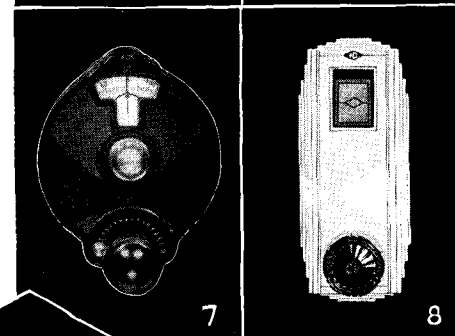

NATIONAL COMPANY, INC.

# NATIONAL *Transmitting* CONDENSERS

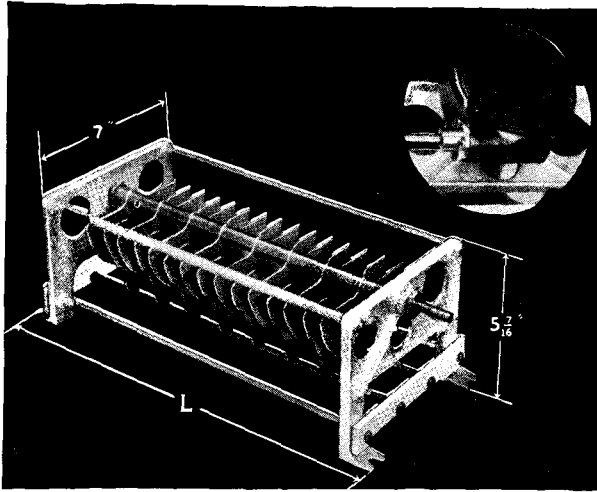

## TML {Heavy Duty, Inexpensive}

The TML condenser is a 1 KW job through-out. Isolantite insulators, specially treated against moisture absorption, prevent flash-overs. A large self-cleaning rotor contact provides high current capacity. Thick capacitor plates, with accurately rounded and polished edges, provide high voltage ratings. Sturdy cast aluminum end frames and dural tie bars permit an unusually rigid structure. Precision end bearings insure smooth turning and permanent alignment of the rotor. End frames are arranged for panel, chassis or standoff mounting. And a PW-type self-locking right-angle drive unit can be easily added to provide precision tuning and convenient parallel-panel mounting.

Type PWL Drive Unit. **List Price, \$9.50 extra**

Capacity	Peak V.	Airgap	Length	Plates	Cat. Symbol	List Price
75 Mmf.	20,000	.719"	18 1/8"	17	TML-75E	<b>\$23.50</b>
150	15,000	.469"	18 1/8"	27	TML-150D	<b>24.25</b>
100	15,000	.469"	14 1/8"	19	TML-100D	<b>21.50</b>
50	15,000	.469"	8 3/4"	9	TML-50D	<b>16.50</b>
245	10,000	.344"	18 1/8"	35	TML-245B+	<b>26.25</b>
150	10,000	.344"	14 1/8"	21	TML-150B+	<b>23.50</b>
100	10,000	.344"	11 3/8"	15	TML-100B+	<b>22.50</b>
75	10,000	.344"	8 3/4"	11	TML-75B+	<b>16.50</b>
500	7,500	.219"	18 1/8"	49	TML-500A+	<b>32.50</b>
350	7,500	.219"	14 1/8"	33	TML-350A+	<b>25.50</b>
250	7,500	.219"	11 3/8"	25	TML-250A+	<b>23.50</b>
30-30	20,000	.719"	18 1/8"	7-7	TML-30DE	<b>24.00</b>
60-60	15,000	.469"	18 1/8"	11-11	TML-60DD	<b>26.00</b>
100-100	10,000	.344"	18 1/8"	15-15	TML-100DB+	<b>28.50</b>
50-50	10,000	.344"	14 1/8"	9-9	TML-50DB+	<b>25.00</b>
200-200	7,500	.219"	18 1/8"	21-21	TML-200DA+	<b>32.50</b>
100-100	7,500	.219"	11 3/8"	11-11	TML-100DA+	<b>26.50</b>

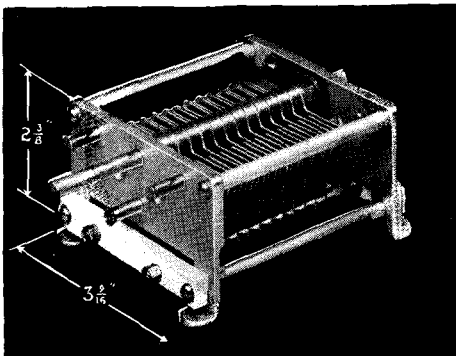

## TMC {Moderate Power, Compact}

Also of new design, the TMC is designed for use in the power stages of transmitters, where peak voltages do not exceed 3000. The frame is extremely rigid and arranged for mounting on panel, chassis or stand-off insulators. The plates are aluminum, with buffed edges. Insulation is Isolantite, located outside of the concentrated electrostatic field. The stator in the split stator model is supported at both ends.

Capacity	Peak V.	Airgap	Length	Plates	Cat. Symbol	List Price
50 Mmf.	3000	.077"	3"	7	TMC-50	<b>\$4.00</b>
100	3000	.077"	3 1/2"	13	TMC-100	<b>4.25</b>
150	3000	.077"	4 5/8"	21	TMC-150	<b>4.75</b>
300	3000	.077"	6 3/4"	39	TMC-300	<b>5.50</b>
100-100	3000	.077"	6 3/4"	13-13	TMC-100D	<b>7.50</b>

## NATIONAL COMPANY, INC., MALDEN, MASS.

Only the most popular sizes of condensers, as carried in stock by our dealers, are listed above. Other sizes can be promptly supplied from standard parts on special order at the same price as the next largest size in the tables above.

A rotor shaft lock can be supplied for either the TMC or the TMA condensers. See page eleven for details.

# NATIONAL *Transmitting* CONDENSERS

## TMA {Heavy Duty}

Newly designed, the TMA is a larger model of the popular TMC. The frame is extremely rigid and arranged for mounting on panel, chassis or stand-off insulators. The plates are of heavy aluminum with rounded and buffed edges. Insulation is Isolantite, located outside of the concentrated field.

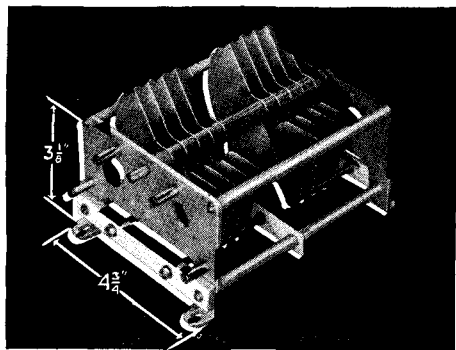

Capacity	Peak V	Airgap	Length	Plates	Cat. Symbol	List Price
300 Mmf.	3000	.077"	4 9/16"	23	TMA-300	\$11.00
200-200	3000	.077"	6 7/8"	16-16	TMA-200D	13.50
50	6000	.171"	4 9/16"	8	TMA-50A	6.00
100	6000	.171"	6 7/8"	17	TMA-100A	9.00
150	6000	.171"	6 7/8"	23	TMA-150A	11.00
230	6000	.171"	9 5/16"	35	TMA-230A	14.50
50-50	6000	.171"	6 7/8"	9-9	TMA-50DA	10.00
100-100	6000	.171"	9 5/16"	15-15	TMA-100DA	16.00
100	9000	.265"	9 1/4"	23	TMA-100B	12.00
150	9000	.265"	12 1/2"	35	TMA-150B	15.50
60-60	9000	.265"	12 1/2"	15-15	TMA-60DB	17.00
50	12000	.359"	7 1/8"	13	TMA-50C	7.25
100	12000	.359"	12 7/8"	27	TMA-100C	13.00
40-40	12000	.359"	12 7/8"	11-11	TMA-40DC	12.00

## TMS {Low Power, Compact, Inexpensive}

Type TMS is a condenser designed for transmitter use in low power stages. It is compact, rigid, and dependable. Provision has been made for mounting either on the panel, on the chassis, or on two stand-off insulators.

Insulation is Isolantite. Voltage ratings listed are conservative.

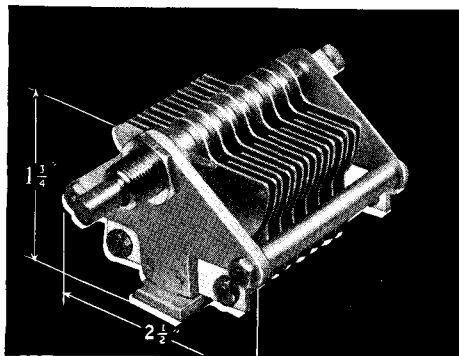

Capacity	Peak V.	Airgap	Length	Plates	Cat. Symbol	List Price
100 Mmf.	1000	.026"	2 3/4"	10	TMS-100	\$2.25
150	1000	.026"	2 3/4"	14	TMS-150	2.50
250	1000	.026"	2 3/4"	23	TMS-250	2.75
300	1000	.026"	2 3/4"	27	TMS-300	3.25
50-50	1000	.026"	2 3/4"	5-5	TMS-50D	3.50
100-100	1000	.026"	2 3/4"	9-9	TMS-100D	4.25
35	2000	.065"	2 3/4"	8	TMSA-35	2.75
50	2000	.065"	2 3/4"	11	TMSA-50	3.00

**NATIONAL COMPANY, INC., MALDEN, MASS.**

Only the most popular sizes of condensers, as carried in stock by our dealers, are listed above. Other sizes can be promptly supplied from standard parts on special order at the same price as the next largest size in the tables above.

A rotor shaft lock can be supplied for either the TMC or the TMA condensers. See page eleven for details.

# NATIONAL *Receiving* CONDENSERS

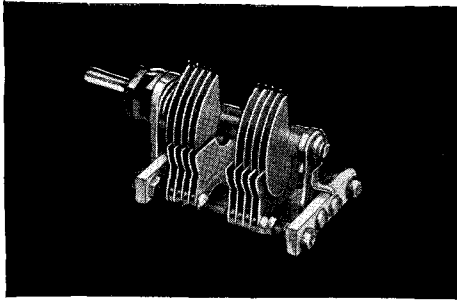

### ST 180° Straight-Line-Wavelength

The ST Condenser has 180° Straight-Line-Wavelength plates. General construction is the same as the SE Condenser although its overall height is less. For minimum overall length, a single bearing model—the STHS—is offered. All other models are double bearing. Two split-stator models are available.

Capacity	Air Gap	Plates	Length	Cat. Symbol	List Price
15	.018"	3	1 <sup>3</sup> / <sub>16</sub> "	STHS 15	\$1.40
25	.018"	4	1 <sup>3</sup> / <sub>16</sub> "	STHS 25	1.50
50	.018"	7	1 <sup>3</sup> / <sub>16</sub> "	STHS 50	1.60
35	.026"	8	2 <sup>1</sup> / <sub>4</sub> "	ST 35	1.50
50	.026"	11	2 <sup>1</sup> / <sub>4</sub> "	ST 50	1.80
75	.026"	15	2 <sup>1</sup> / <sub>4</sub> "	ST 75	2.00
100	.026"	20	2 <sup>1</sup> / <sub>4</sub> "	ST 100	2.25
140	.026"	28	2 <sup>3</sup> / <sub>4</sub> "	ST 140	2.50
150	.026"	29	2 <sup>3</sup> / <sub>4</sub> "	ST 150	2.50
200	.018"	27	2 <sup>1</sup> / <sub>4</sub> "	STH 200	2.75
250	.018"	32	2 <sup>3</sup> / <sub>4</sub> "	STH 250	3.00
300	.018"	39	2 <sup>3</sup> / <sub>4</sub> "	STH 300	3.25
335	.018"	43	2 <sup>3</sup> / <sub>4</sub> "	STH 335	3.50
50-50	.026"	11-11	2 <sup>3</sup> / <sub>4</sub> "	STD 50	3.50
100-100	.018"	14-14	2 <sup>3</sup> / <sub>4</sub> "	STHD 100	4.50

### SS 180° Straight-Line Capacity

The SS Condenser has 180° Straight-Line-Capacity plates and except for this detail is the same in all other respects as the ST condenser. When ordering, substitute SS for ST under the catalog symbol column in the listing at the right.

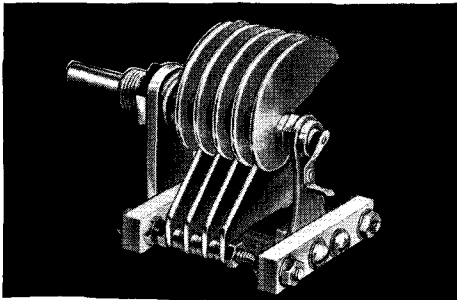

Capacity	Air Gap	Plates	Length	Cat. Symbol	List Price
15	.055"	6	2 <sup>1</sup> / <sub>4</sub> "	SEU 15	\$2.50
20	.055"	7	2 <sup>1</sup> / <sub>4</sub> "	SEU 20	2.75
25	.055"	9	2 <sup>1</sup> / <sub>4</sub> "	SEU 25	2.75
50	.026"	11	2 <sup>1</sup> / <sub>4</sub> "	SE 50	3.00
75	.026"	15	2 <sup>1</sup> / <sub>4</sub> "	SE 75	3.25
100	.026"	20	2 <sup>1</sup> / <sub>4</sub> "	SE 100	3.50
150	.026"	29	2 <sup>3</sup> / <sub>4</sub> "	SE 150	3.75
200	.018"	27	2 <sup>1</sup> / <sub>4</sub> "	SEH 200	3.75
250	.018"	32	2 <sup>3</sup> / <sub>4</sub> "	SEH 250	4.00
300	.018"	39	2 <sup>3</sup> / <sub>4</sub> "	SEH 300	4.00
335	.018"	43	2 <sup>3</sup> / <sub>4</sub> "	SEH 335	4.25

### SE 270° Straight-Line-Frequency

The SE Condenser has 270° Straight-Line-Frequency plates. Insulation is Isolantite. All models have two rotor bearings, the front bearing being insulated to prevent noise. The rotor contact is through a constant impedance pigtail. The SEU models are suitable for high voltages as their plates are thick polished aluminum with rounded edges. The other SE models do not have this feature.

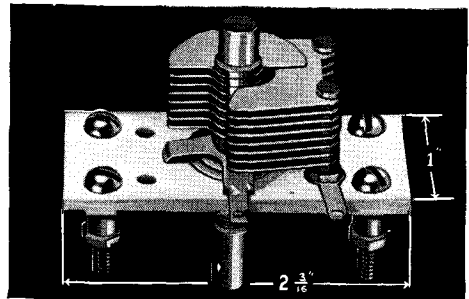

### UM (Ultra Midget)

The UM Condenser is designed for ultra high frequency use and is small enough for convenient mounting in our square shield cans. They are particularly useful for tuning receivers, transmitters and excitors. Shaft extensions at each end of the rotor permit easy ganging when used with one of our flexible couplings. The UMB-25 Condenser is a balanced stator model, two stators act on a single rotor. The UM can be mounted by the angle foot supplied or by bolts and spacers, as illustrated.

Capacity	Air Gap	Plates	Cat. Symbol	List Price
15 Mmf.	.017"	6	UM- 15	\$1.25
35	.017"	12	UM- 35	1.50
50	.017"	16	UM- 50	1.60
75	.017"	22	UM- 75	1.70
100	.017"	28	UM-100	1.90
25	.050"	14	UMA- 25	1.85
25	.017"	4-4-4	UMB- 25	1.85

## NATIONAL COMPANY, INC., MALDEN, MASS.

If an extended shaft is wanted for ganging on either the ST or the SS Series of Condensers listed above, add the letter E to the standard catalog symbol. Prices are the same.



# NATIONAL *Special Purpose* CONDENSERS

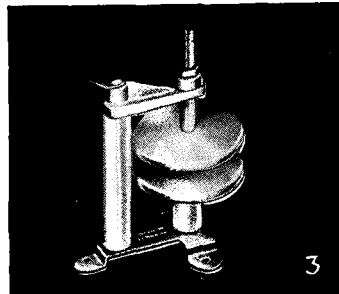
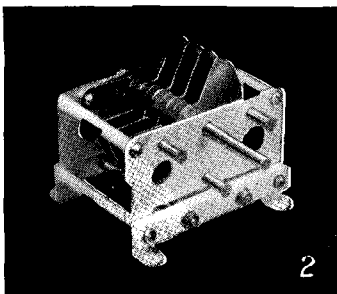
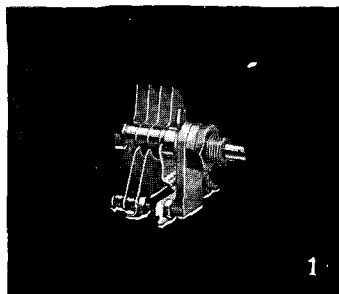

## NEUTRALIZING CONDENSERS

**STN (Fig. 1)** A compact, rigid, and efficient condenser particularly suitable for neutralizing 245, 247, 210 and similar tubes in amplifier, buffer or doubler stages. Very low minimum capacity. Isolantite insulation. Maximum capacity 18 mmf. Peak voltage breakdown — 3000v. **List Price, \$2.00**

**TCN (Fig. 2)** A heavy duty neutralizing condenser having a peak voltage rating of 6000 volts. Suitable for use with 203A, 852, 204A and similar tubes. Maximum capacity 25 mmf. **List Price, \$3.50**

**NC 800 (Fig. 3)** A high voltage neutralizing condenser, suitable for use with the RCA-800. Insulation is Isolantite. For capacity-air gap relation see Figure 8. **List Price, \$3.00**

**NC-150 (Fig. 6)** A heavy duty condenser designed to neutralize such tubes as the HK 345, RK 36, 300 T and 852. The NC-500, a still larger condenser, is available for neutralizing the W.E. 251A and similar tubes. See Figure 8 for capacity-air gap relation.

Type NC-150  
Type NC-500

**List Price, \$6.00**  
**List Price, \$10.00**

## GENERAL PURPOSE

**EMC (Fig. 5)** National EMC Condensers have high electrical efficiency, and calibrations may be relied on. Insulation is Isolantite, and Peak Voltage Rating is 1000 volts. Plate Shape is SLW.

Capacity	No. of Plates	Cat. Symbol	List Price
150	9	EMC 150	<b>\$3.00</b>
250	14	EMC 250	<b>3.50</b>
350	18	EMC 350	<b>3.75</b>
500	26	EMC 500	<b>4.00</b>
1000	56	EMC 1000	<b>6.50</b>

### Split-Stator Models

350-350	18-18	EMCD-350	<b>6.75</b>
---------	-------	----------	-------------

## PADDING CONDENSERS

National Air-Dielectric Padding Condensers (Fig. 4) are extremely compact and have a very low temperature coefficient. The aluminum shield is 1 1/4" diameter by 1 1/4"-1 1/2" high.

A very small mica Padding Condenser (Fig. 7) is also available, mounted on an Isolantite base and designed to be supported by the circuit wiring. The maximum capacity is 30 mmf., and the overall dimensions are 13/16" long x 9/16" wide x 1/2" high.

W 75 (75 Mmf. Air)

**List Price, \$2.25**

W 100 (100 Mmf. Air)

**List Price, 2.50**

M 30 (30 Mmf. Mica)

**List Price, .30**

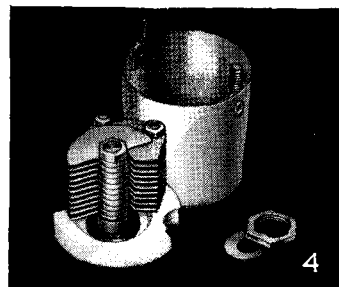
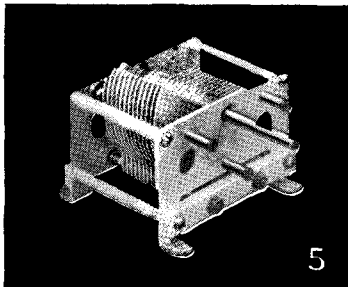
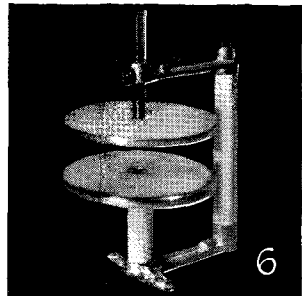
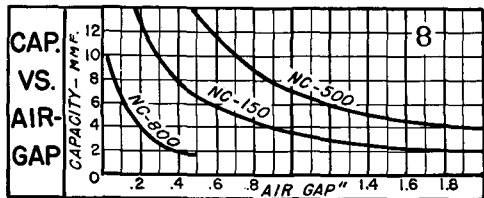

**NATIONAL COMPANY, INC., MALDEN, MASS.**

# PARTS

## R.F. CHOKES

**R-100.** Isolantite mounting, continuous universal winding in four sections. For pigtail connections or standard resistor mountings. Inductance  $2\frac{1}{2}$  m.h.; distributed capacity, 1 mmf.; D.C. resistance 50 ohms; Current rating, 125 M.A. For low powered transmitters and high frequency receivers.

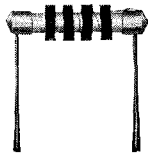

List Price, \$ .75

**R-152, R-154, R-154U.** These transmitter chokes have honeycomb coils (0.6 amps. rating) wound on Isolantite cores. The R-152 is designed for the 80 and 160 meter bands; inductance 4 m.h., D.C. resistance 10 ohms. The R-154 and R-154U give maximum impedance on the 20, 40 and 80 meter bands; inductance 1 m.h., D.C. resistance 6 ohms. The R-152 and R-154 are as illustrated. The R-154U does not have the small insulating pillar and the third mounting foot.

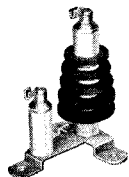

R-152 or R-154  
R-154U

List Price, \$2.25  
List Price, 1.75

**R-201.** A two-section honeycomb-wound choke in R-39 case, suitable for output circuit of second detector in H.F. receivers (475 KC Intermediate Frequency). Inductance, approximately 12 m.h., D.C. resistance approximately 120 ohms.



List Price, \$1.25

## TWIN DIODE TRANSFORMER

**I.F.D.** This transformer is designed for use in the new noise silencing circuits, and in detector and a.v.c. circuits where the secondary will be working into a diode detector tube. The primary is tuned by an air dielectric condenser with aluminum plates. The secondary is untuned, closely coupled, for push-pull output. The condenser and coils are mounted on an Isolantite base treated against moisture absorption.

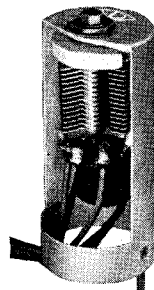

I.F.D., 450-550 KC.

List Price, \$3.50

## I.F. TRANSFORMER

This new I.F. Transformer has air dielectric condensers (isolated from each other by an aluminum shield) and Litz wound coils mounted on an Isolantite base which is treated against moisture absorption. The aluminum shield can, housing the assembly, measures  $4\frac{1}{8}$ " x  $2\frac{3}{8}$ " x 2". These transformers are available with or without Iron Cores in two models 175 K.C. or 450-550 K.C. For Iron Core add \$.50 to list price.

Type IFC Transformer (air core)

List Price, \$5.00

Type IFCO Oscillator (air core only)

List Price, \$5.00

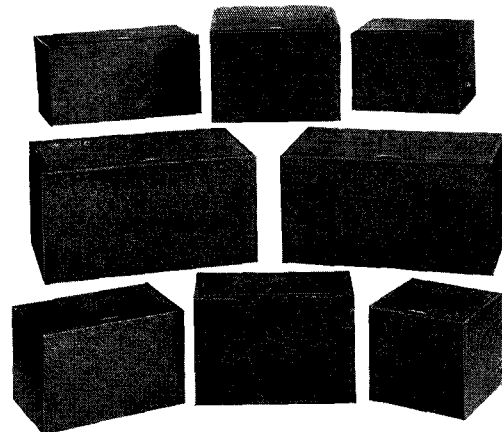
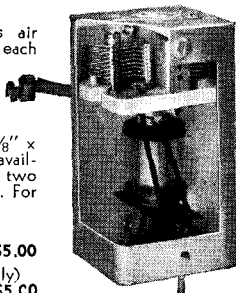

## STANDARD CABINETS

The National Receiver Cabinets illustrated above, are for use in constructing special equipment. List Prices include sub-bases and bottom covers. Reading left to right:

Top Row	Width	Height	Depth	List Price
Type C-HWR	13 $\frac{1}{2}$ "	7"	7 $\frac{1}{4}$ "	\$5.00
Type C-FB7	11 $\frac{1}{2}$ "	8"	12"	7.00
Type C-SW3	9 $\frac{3}{4}$ "	7"	9"	5.50
Middle Row				
Type C-NC100	17 $\frac{1}{4}$ "	8 $\frac{3}{4}$ "	11 $\frac{1}{4}$ "	8.50
Type C-HRO	16 $\frac{3}{4}$ "	8 $\frac{3}{4}$ "	10"	8.50
Bottom Row				
Type C-One-Ten	11"	7"	7 $\frac{1}{4}$ "	4.50
Type C-PSK	6"	8"	12"	6.00
Type C-SRR	7 $\frac{1}{2}$ "	7"	7 $\frac{1}{2}$ "	3.50

## TUBE AND COIL SHIELDS

The Aluminum Shields shown are from left to right:

Type	List Price
HRO coil shield, 2" x 2 $\frac{3}{8}$ " x 4 $\frac{1}{8}$ " high	\$ .35
J30 coil shield, 2 $\frac{1}{2}$ " dia. x 3 $\frac{3}{4}$ " high	.35
B30 coil shield, 3" dia. x 3 $\frac{3}{4}$ " high	.50
B30 coil shield, with mounting base	.40
TS Tube Shield, with cap and mounting base	.40
T58 Tube Shield, with cap and mounting base	.40
T78 Tube Shield, with cap and mounting base	.40

The T58 and T78 fit such tubes as the 57, 58, 77, 78, etc.

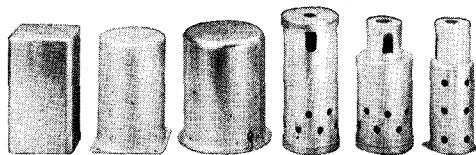

## CODE PRACTICE OSCILLATOR

This small audio oscillator is suitable for either code practice, or as an audio signal source for ICW on the Ultra High Frequency Bands.

A type 30 tube is used, and four flashlight cells in the case provide filament and plate current.

Type CPO, without batteries or tube. List Price, \$6.00

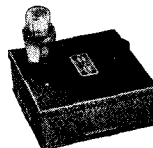

**NATIONAL COMPANY, INC., MALDEN, MASS.**

# PARTS

## LOW-LOSS COIL FORMS

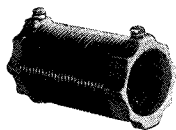

The transmitter coil forms listed below are low-loss ceramic coil forms designed for high efficiency and should not be confused with ordinary porcelain forms. A data sheet, supplied with each coil form, makes it extremely easy to

determine the correct wire turns to use on any of the amateur bands.

XR-10A, Low-Loss Ceramic, 20 or 40 meter.  
**List Price, \$1.50**

XR-12A, Low-Loss Ceramic, 160 meter.  
**List Price, 2.25**

XR-13, Isolantite (1 3/4" dia. x 3 1/2" long).  
**List Price, 1.00**

**RECEIVER COIL FORM.** These well-known R-39 forms are machinable, permitting the experimenter to groove and drill them to suit individual requirements. They are available in 4-, 5- and 6-prong types, and plug into the sockets shown on this page. Length, 2 1/4". Dia. 1 1/2".  
XR-4, XR-5, or XR-6. **List Price, \$.75**

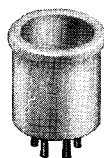
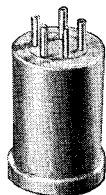

**RECEIVER COIL FORM.** Smaller in size than the R-39 forms listed above and made of Steatite, these forms are drilled for leads and left unglazed to provide a tooth for coil dope. They have 5 or 6 prongs.  
Type XR-20. **List Price, \$.35**

**PLUG-IN COIL FORMS.** These R-39 coil forms, originally used in the FB-7, are designed for plugging-in through the front panel of a receiver, monitor, etc. A padding condenser mounts inside the coil, and a special bakelite sleeve protects the winding. The coil shield listed is bolted to the back of the panel, and supports the Isolantite socket.  
XR-39A Coil Form, Air Tuned. **List Price, \$4.75**  
XR-39M Coil Form, Mica Tuned. **List Price, 3.65**  
XCS Coil Shield and Socket. **List Price, 1.75**

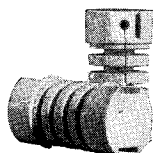
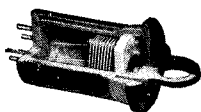

**COIL FORM.** This Steatite Choke Coil Form is ideally suited for small choke coils and precision resistors. The winding is divided in four sections by partitions. A slot is provided for leading the wire from section, and to the terminals.  
Type XT-8. **List Price, \$.50**

**GRID GRIPS.** This convenient little Grid-Grip is the most simple method of attaching a wire to the metal top-cap terminal of multi-element tubes. Easy to operate, never works loose, makes continuous electrical contact. Eliminates possibility of loosening cap on tube when removing lead. Made in three sizes.  
Type 24 — to fit broadcast set tubes. **List Price, \$.05**  
Type 12 — to fit large type tubes. **List Price, .10**  
Type 8 — to fit metal tubes. **List Price, .05**

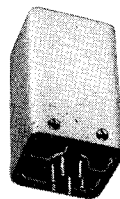

## PLUG-IN BASE AND SHIELD

The low-loss R-39 base has prongs moulded in for easy plug-in mounting. This unit is ideal for mounting condensers and coils when it is desirable to have them shielded and easily removable from a circuit. Four mounting holes that match our UM condenser are provided. The Aluminum Shield can is 2" x 2 3/8" x 4 1/8". Two models are available.  
Type PB-10 (either 5 or 6 prong). **List Price, \$.75**

## COIL DOPE

National Coil Dope is a special Victron base R.F. lacquer prepared to give a low power factor. Used as a cement for holding windings in place, it does not spoil the low-loss properties of the coil form.  
Per Can. **List Price, \$1.50**

## VICTRON SHEET

The Loss Factor (0.2) of this non-hydroscopic material is 1/8 of "Low-Loss" rubber and 1/90 of the usual R.F. insulators. Its Power Factor is .06%-.08%. Ideal for mounting high frequency gear and it is readily drilled or sawed. In color it is a transparent amber.  
12" x 6" x 3/16" thick sheet. **List Price, \$6.00**  
12" x 6" x 1/8" thick sheet. **List Price, 5.00**  
6" x 3" x 3/16" thick sheet. **List Price, 1.50**  
6" x 3" x 1/8" thick sheet. **List Price, 1.25**

## LOW FREQUENCY OSCILLATOR

**COIL.** Two separate inductances, closely coupled, in an aluminum shield. It is used in the SRR and other super-regenerative receivers for the interruption-frequency oscillator. Sec. Inductance 6.25 m.h. Tunes to 100 K.C. with .00041 Mfd.  
Type OSR. **List Price, \$1.50**



**MIDGET COIL FORM.** Made of low-loss R-39, these small coil forms are designed with excellent form factor, contributing to high efficiency in H. F. circuits. Diameter, 1"; Length, 1 1/8"; Wall thickness, 1/16". They are available with 4 prongs, or plain.  
Type XR-1, four prongs. **List Price, \$.50**  
Type XR-2, without prongs. **List Price, .35**



# PARTS

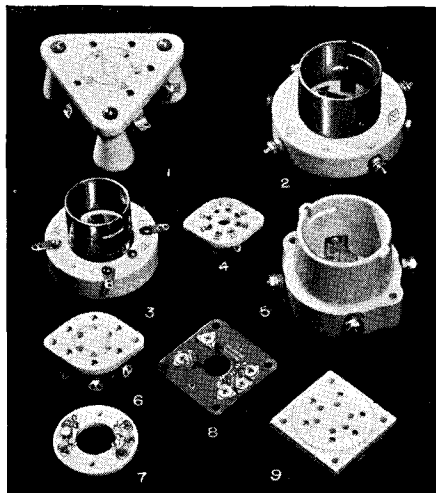

## LOW-LOSS SOCKETS

The sockets illustrated above will meet every amateur need.

1 is a wafer type Isolantite socket for power Pentodes such as the RK-28 and the RCA-803.

Type JX-100S, as illustrated. **List Price, \$3.60**

Type JX-100, as above but without stand-off insulators. **List Price, \$3.00**

2 is a fifty watt socket with sturdy side wipe contacts and employs the conventional bayonet-lock metal shell.

Type XM-50. **List Price, \$1.75**

3 is a socket, similar in construction to the XM-50, designed for those tubes using the type UX base.

Type XM-10. **List Price, \$1.25**

4 is an Isolantite wafer socket for the Octal (metal) tubes.

Type 8 prong. **List Price, \$ .60**

5 is another 50 watt socket made entirely of low-loss Steatite and is for higher frequencies and voltages than the XM-50.

Type XC-50. **List Price, \$3.50**

6 is one of the complete line of National Isolantite Receiving Sockets that fit all standard receiving tubes.

Types 4 prong, 5 prong, 6 prong, 7 prong — small.

7 prong — large. **List Price, \$ .60 each**

7 is an Isolantite socket for the Triode Acorn tube. The socket contacts are of a new design providing very short leads and have a current path nearly independent of tube position.

Type XCA. **List Price, \$1.50**

8 is for the Pentode Acorn tube and is assembled, with the same type of contacts as the XCA, on a square copper base with built-in by-pass condensers for stable high frequency operation.

Type XMA **List Price, \$1.50**

9 is a square Isolantite coil socket designed to fit National 6 pin coils. A wafer type socket, similar to figure 6, is also available to fit these same coil forms.

Type 6 prong Square Coil Socket **List Price, \$.75**

Type 6 prong Wafer Coil Socket **List Price, \$.60**



## SHAFT COUPLINGS

The small coupling illustrated at the left has Steatite insulation, providing high electrical efficiency when used to isolate circuits.

Type TX-9. **List Price, \$1.00**

The small coupling illustrated at the right is well known and liked for its small size and freedom from backlash. Insulation is canvas bakelite.

Type TX-10. **List Price, \$.55**



## FLEXIBLE SHAFT COUPLING

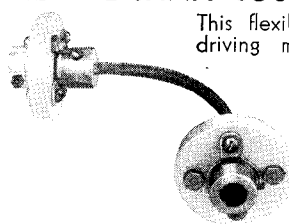

This flexible shaft, providing a driving means between offset shafts or shafts at angles up to 90 degrees, virtually eliminates mis-alignment problems. Available with either plain hubs or with Isolantite insulation. Hubs fit 1/4" shafts.

Type TX-11, hubs not insulated.

Type TX-12, as illustrated. **List Price, \$ .60**

**List Price, 1.25**

## HIGH VOLTAGE COUPLING

This coupling provides high insulation with compact size.

The insulation is glazed Isolantite. TX-1 has a leakage path of 1", and TX-2 a leakage path of 2 1/2".

Type TX-1.

Type TX-2.



**List Price, \$1.00**

**List Price, 1.10**

## FIXED TUNED EXCITER TANK

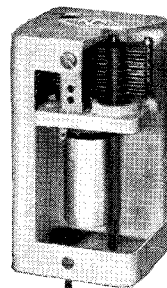

Mounted on the Isolantite base are two 25 mmf. condensers (2000 volts — isolated from each other by an aluminum shield) and an R-39 coil form (1 1/2" x 1" diameter). The assembly is enclosed in an aluminum can, 4" x 2 3/8" x 2". This unit is also available with the Plug-In Base shown on page 9 which makes it ideal for conveniently and rapidly changing transmitting frequencies.

Type FXT without plug-in base.

**List Price, \$4.50**

Type FXTB with plug-in base (either 5 or 6 prong).

**List Price, \$4.90**

**NATIONAL COMPANY, INC., MALDEN, MASS.**

# PARTS

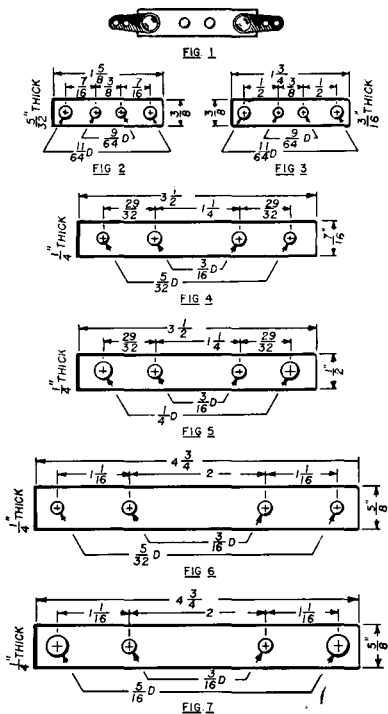

**INSULATORS:** A number of our standard condenser insulators are shown above. In addition to their obvious use as repair parts they may be used for a variety of other purposes such as supports for coils, spreaders, etc. The insulator shown in Fig. 1 is the same as Fig. 3, but has a metal solder lug riveted to each end. It is useful as a 5-meter lead-in spreader, or as a mounting for 5-meter inductances.

- |                                    |            |        |
|------------------------------------|------------|--------|
| Fig. 1.                            | List Price | \$3.00 |
| Fig. 2. (Fits ST Condenser), each  |            | .15    |
| Fig. 3. (Fits SE Condenser), each  |            | .15    |
| Fig. 4. (Fits TMC Condenser), each |            | .30    |
| Fig. 5. (Fits TMC Condenser), each |            | .30    |
| Fig. 6. (Fits TMA Condenser), each |            | .40    |
| Fig. 7. (Fits TMA Condenser), each |            | .40    |

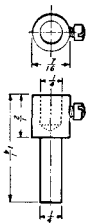

**SHAFT EXTENSION.  
SCREW LUG.**

List Price \$ .25  
List Price \$ .15

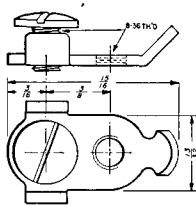

**H.F. BUSHING:** This small Steatite bushing has many uses in Amateur equipment. Type XS-6 List Price, \$1.10

**SHAFT BUSHING:** A bushing that gives a professional touch to equipment where 1/4" shafts have to be brought through panels. Type SB List Price, \$2.25

**ROTOR SHAFT LOCK:** This lock is designed to clamp securely either the TMA or the TMC rotor shafts.

Type RSL List Price, \$ .85

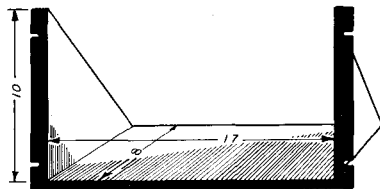
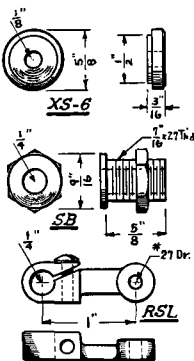

FIG. 10

**RELAY RACK SHELF:** This recessed shelf will fit any standard relay rack, and is particularly useful for supporting portable equipment, instruments, test equipment, etc., Type RRS. List Price \$4.00

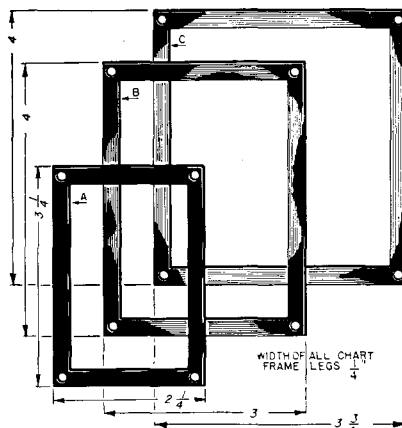

FIG. 11

**COIL CHART FRAMES:** Nickel Silver Chart Frames are available in the sizes shown above. The largest frame is the same as that used on the AGS, the medium frame is the same size as that on the FB-7, and the smallest is the same as the HRO frame. Prices include celluloid sheet to protect the chart.

- |         |                |     |
|---------|----------------|-----|
| Size A. | List Price, \$ | .50 |
| Size B. | List Price, \$ | .60 |
| Size C. | List Price, \$ | .70 |

**NATIONAL COMPANY, INC., MALDEN, MASS.**

# NATIONAL *High Frequency* RECEIVERS



## STANDARD HRO RECEIVER

National has built into this receiver every feature the most advanced amateur requires.

The two preselector stages give remarkable image frequency suppression, weak signal response and high Signal-to-Noise Ratio. The two high gain I.F. stages employ Litz-wound coils and are tuned with air condensers. The useable sensitivity and selectivity are exceptional. Other circuit details are automatic and manual volume control, a vacuum tube voltmeter calibrated in "S" units for carrier intensities, a phone jack, a Send-Receive switch and a Lamb Single Signal crystal filter. This filter makes selectivity adjustable over a wide range and the circuits are so precisely balanced that heterodyning signals may be completely phased out.

Most notable among the mechanical details is the PW precision four-gang condenser, described in detail on page 2.

For best performance, a reliable speaker should be chosen with an input impedance of 7000 ohms. The Monitor speaker listed on page 17 is recommended or a similar speaker can be furnished in a cabinet to match the HRO at a list price of \$23.50.

### OUTSTANDING FEATURES

- Nine Tubes, not including rectifier
- Single Signal (Crystal Filter)
- Ganged Plug-in-Coils, each coil shielded
- Strictly single control tuning
- Four gang PW condenser
- Micrometer Dial, tuning over 500 divisions
- "S" meter
- Two I.F. stages — Litz-wound coils, air condenser tuned
- Beat Frequency Oscillator for "Offset" C.W. Tuning
- Two Preselector Stages

STANDARD HRO Receiver, table model, complete with tubes and four sets of coils covering range 1.7 MC to 30 MC, but no speaker or power supply — 2½ volt A.C. or 6 volt battery model.

**List Price, \$279.50**

STANDARD HRO Receiver, relay rack model — 2½ volt A.C. or 6 volt battery model. **List Price, \$299.50**  
Specify Grey or Black finish.

5897 AB Power Supply — less tube — for above receiver. **List Price, \$26.50**

Shipping weights: Receiver 62 pounds, power supply 15 pounds.

**NATIONAL COMPANY, INC., MALDEN, MASS.**

# NATIONAL *High Frequency* RECEIVERS

## GANGED PLUG-IN COILS      CALIBRATED BAND-SPREAD

The plug-in coils of the HRO are ganged for easy handling and individually shielded for stability. When these coils are used for general coverage, each of the 4 coils includes two amateur bands and the spectrum between. A simple switching device is provided which makes these same coils band-spread their respective amateur bands (except 160) over a span of 400 divisions on the dial. Each set of coils is accurately calibrated at the factory and the complete set of four coils, as supplied with each standard HRO, covers the range from 1.7 MC to 30 MC.

Additional sets of coils are available only as listed below.

100-200 KC  
175-400 KC  
500-1000 KC  
900-2000 KC

List Price, \$30.00  
List Price, 27.50  
List Price, 20.00  
List Price, 20.00

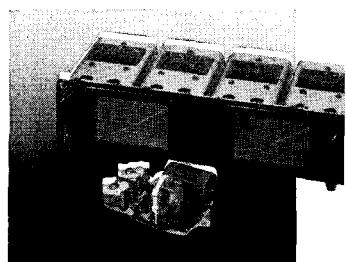

## JUNIOR HRO RECEIVER

For those who require the high performance of the Standard HRO but do not need its extreme versatility, the HRO Junior is offered. The circuit and mechanical details of both receivers are identical in every respect, but the lower priced model has been greatly simplified by omitting the Lamb Single-Signal crystal filter, the "S" meter, and by designing coils for continuous band spread only.

Although these omissions do not greatly restrict its usefulness, they make it possible to price the HRO Junior at a very attractive figure.

HRO JUNIOR RECEIVER table model, complete with tubes and one set of coils, 10 to 20 meters (2 amateur bands) but no speaker or power supply — 2½ volt A.C. or 6 volt battery model.

List Price, \$165.00

Additional HRO Junior Coils (2 amateur bands per coil).

List Price, 16.50

5897 AB Power Supply — less tube — for above receiver.

List Price, 26.50

## THE STANDARD HRO

## THE HRO JUNIOR

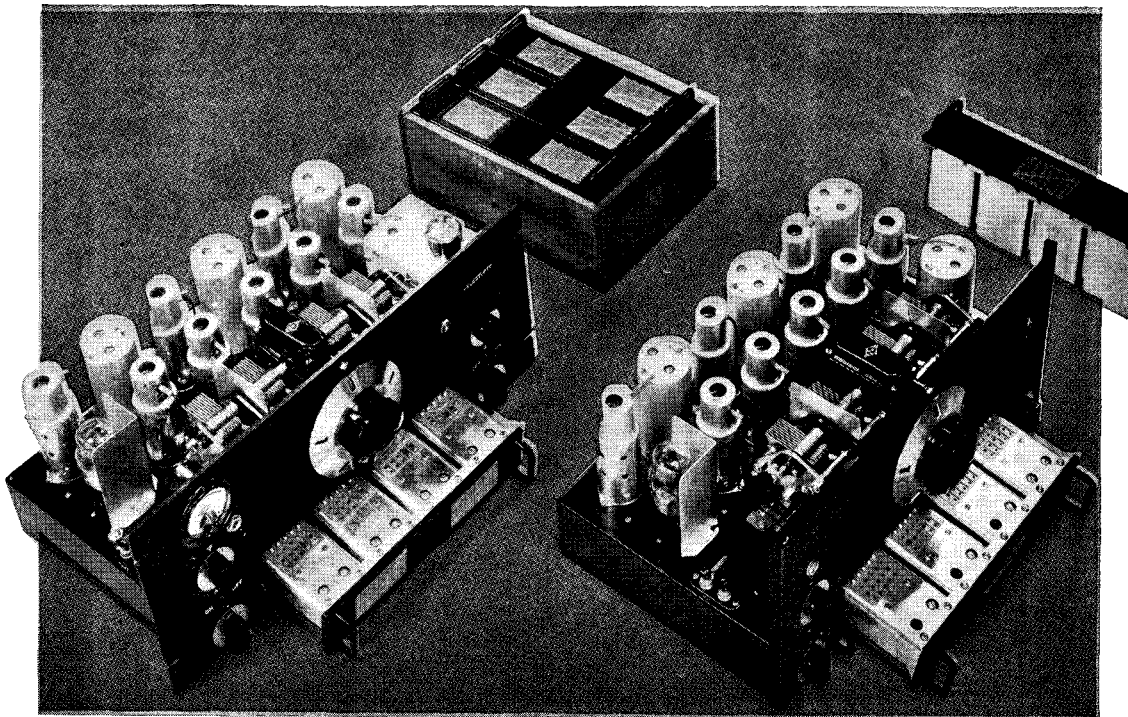

**NATIONAL COMPANY, INC., MALDEN, MASS.**

An engineering bulletin describing the above receivers in detail will be mailed on request.



# NATIONAL High Frequency RECEIVERS

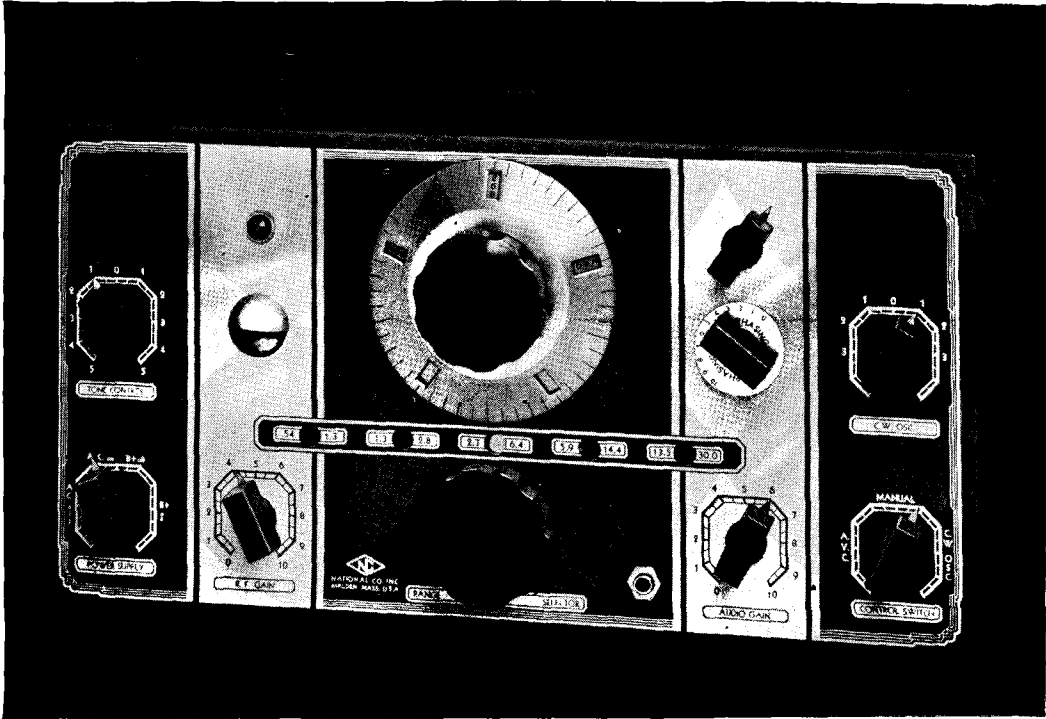

## NC-100 RECEIVER

This receiver is a 12 tube superheterodyne covering the range of 540 KC to 30 MC. Except for the speaker, the NC-100 is self-contained in a table model cabinet which is readily adaptable to relay rack mounting by brackets supplied at a slight additional charge.

One stage of R.F. and two stages of I.F. are used. Low-loss insulation and high-Q coils give ample sensitivity and selectivity. The crystal filter built into the NC-100 X models, has variable selectivity and phasing controls. Separate R.F. and Audio Gain Controls permit complete control of the receiver. A 6E5 tuning indicator tube, with provision for signal strength measurement, provides an added convenience. Other controls are Tone, C.W. Oscillator, AVC with amplified and delayed action, a B+ switch, and a Phone Jack. A self-contained power supply provides all necessary voltages including speaker field excitation.

The range changing system is unique in that it combines the mechanical convenience of a coil switch with the electrical efficiency of plug-in coils. The coils are, in effect, automatically plugged in. A twist

of the Range Selector Knob brings the desired set of coils into position and plugs them in. This mechanism is well supported by the PW Dial and Drive, direct reading to one part in 500. Station logging is consistent and calibration permanent.

NC-100 Receiver — complete with tubes, built in power supply and 10" dynamic speaker chassis.

**List Price, \$188.33**

NC-100 S Receiver — Same as above but with 12" Rola G12 High Fidelity Speaker.

**List Price, \$210.83**

NC-100 X Receiver — Same as NC-100 but with crystal filter and variable selectivity and phasing controls.

**List Price, \$225.83**

NC-100 XS Receiver — Same as NC-100 X but with 12" Rola G-12 High Fidelity Speaker.

**List Price, \$248.33**

DCS Metal Cabinet for 10" Speaker, same finish as receiver.

**List Price, \$8.50**

RRA Relay Rack Adapters, designed for mounting any of the NC-100 Receivers in a standard relay rack.

**List Price, per pair, \$2.50**

**NATIONAL COMPANY, INC., MALDEN, MASS.**

*An engineering bulletin describing the above receivers in detail will be mailed on request.*



# NATIONAL *Ultra High Frequency* RECEIVERS

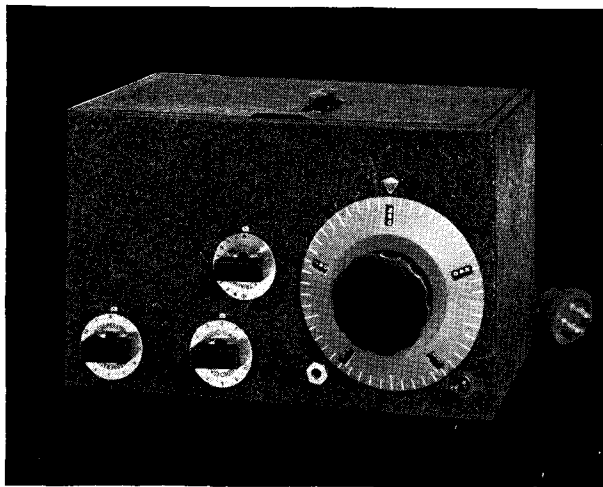

## ONE-TEN RECEIVER

The One-Ten Receiver fulfills the need of the experimenter for an adequate receiver to cover the immense and ever more valuable field between one and ten meters. Designed chiefly for the experimenter, this receiver has been engineered for maximum sensitivity, high signal-to-noise ratio, a wide frequency range, ease of operation and with particular consideration for the characteristics of experimental high frequency transmitters.

A four tube circuit is used, composed of one tuned R.F. stage, a self-quenching super-regenerative detector, transformer coupled to a first stage of audio which is a resistance coupled to a power output stage. Six sets of plug-in coils are used. The popular PW-0 drive and dial are employed as the main tuning control. Three small dials control detector regeneration, audio regeneration, audio gain and alignment of the R.F. circuit. A "B+" switch and

a head-phone jack are mounted on the front panel. Voltage dividers are built in, necessitating only one B voltage lead. The receiver is designed for operation from the National 5886 A B power unit. Batteries may be used if desired (Heater 6 volts, B supply 180 volts). Tubes required: 954-R.F.; 955-Detector; 6C5-1st Audio; 6F6-2nd Audio.

Tubes can be supplied at standard prices

Type 110 Receiver and 6 sets of coils, without tubes, speaker or power supply.

**List Price, \$65.00**

Type 5886 Power Supply for above receiver, less tube.

**List Price, \$26.50**

Shipping Weights: Receiver 16 lbs., Power Supply 17 lbs.

## SW-3 High Frequency RECEIVER

The SW-3 Receivers employ a circuit consisting of one R.F. stage transformer coupled to a regenerative detector and one stage of impedance coupled audio. This circuit, as incorporated in the SW-3, with thorough shielding, grooved R-39 coil forms, Isolantite insulated condensers and tube sockets, etc., provides maximum sensitivity and flexibility with the smallest number of tubes and the least auxiliary equipment. The single tuning dial operates a precisely adjusted two gang condenser; the regeneration control is smooth and noiseless, with no backlash or fringe howl; the volume control is calibrated from one to nine in steps corresponding to the R scale, and is connected in the R.F. amplifier circuit; — the features all contribute to the efficiency and ease of operation so essential to equipment of this type.

The receiver especially suitable for installations where space is limited as in semi-portable or mobile stations, on yachts, etc.

Available in three models — ACSW-3 for AC operation — 6DCSW3 for 6 volt DC operation — 2DCSW3 for 2 volt DC operation. AC Models use "60" Series Coils. DC Models use "10" Series Coils.

Tubes required — 2 Volt AC Model; two 58, one 27 — 6 Volt DC Model; two 36, one 37 — 2 Volt DC; two 32, one 30.

SW-3, any model, without coils, phones, tubes or power supply.

**List Price, \$32.50**

Shipping weight 17 pounds

5880-AB Power Supply, 115 V, 60 cycle, without 80 Rectifier.

**List Price, \$26.50**

Shipping weight 18 pounds

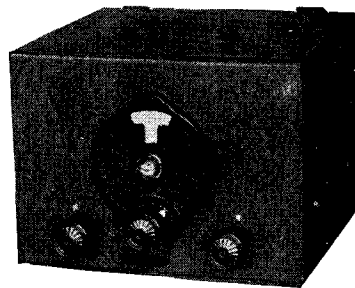

## General Coverage Coils

Catalog Number	Range	List Price Per Pair
10 or 60	9. to 15. meters	\$5.00
11 or 61	13.5 to 25. meters	5.00
12 or 62	23. to 41. meters	5.00
13 or 63	40. to 70. meters	5.00
14 or 64	65. to 115. meters	5.00
15 or 65	115. to 200. meters	5.00
16 or 66	200. to 360. meters	5.50
17 or 67	350. to 550. meters	5.50

Five additional sets of coils are available to cover up to 3000 meters

## Band Spread Coils

10A or 60A	— 10 meter band	\$5.00
11A or 61A	— 20 meter band	5.00
13A or 63A	— 40 meter band	5.00
14A or 64A	— 80 meter band	5.00
15A or 65A	— 160 meter band	5.00

**NATIONAL COMPANY, INC., MALDEN, MASS.**



# NATIONAL *High Frequency* RECEIVERS

## FB-7 Amateur RECEIVER

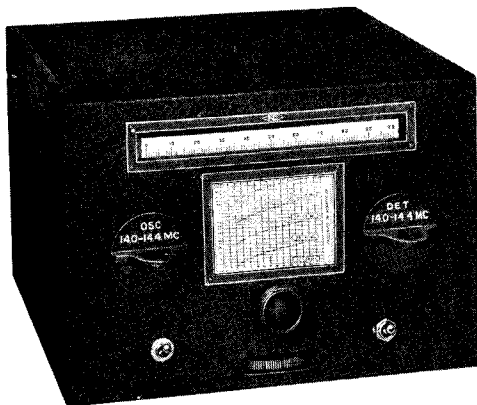

The FB-7 is a seven tube receiver having exceptional sensitivity, selectivity and stability. Ample sensitivity and selectivity are assured through the use of a circuit employing two stages of high-gain air-tuned I.F. amplification. There is no pulling-in or blocking by strong local signals, and frequency drift in both high frequency and beat oscillators has been virtually eliminated. Variation of the volume control has no appreciable effect on the pitch of C.W. signals, even at 14 mc.

A Single-Signal (crystal filter) unit is available, and may be added to the receiver at any time.

Every effort has been made to promote ease of operation. Tuning is strictly single-control, and calibration is permanent. The coils plug-in from the front of the panel without disturbing shielding. Tuning curves are mounted on the front panel. Switches for the C.W. oscillator, and for cutting B voltages during transmission are conveniently located. A phone jack is located in the second detector output circuit.

Tubes required. 2.5-volt type: one 56, one 57, two 58's, one 59, two 24's. 6-volt type: one 37, one 77, two 78's, one 89, two 36's. Power supply requires one type 80 rectifier.

**FB-7-A**, without coils, speaker, tubes or power supply.  
**List Price, \$62.50**

**FBX-A**, as above, but with single-signal (crystal filter) unit, without coils, speaker, tubes or power supply.  
**List Price, \$86.50**

*Shipping weight 23 pounds*

**5897 AB Power Supply** for 2-volt FB receivers, high voltage for maximum audio power, 115-volt, 60 cycles, less tube.  
**List Price, \$26.50**

*Shipping weight 18 pounds*

### General Coverage Coils

Catalog Number	Range	List Price Per Pair
FBA	34 Mc to 18 Mc	\$10.00
FBA	19.5 Mc to 11.4 Mc	10.00
FBB	11.7 Mc to 7 Mc	10.00
FBC	7.3 Mc to 4 Mc	10.00
FBD	4.2 Mc to 2.4 Mc	10.00
FBE	2.5 Mc to 1.5 Mc	10.00
FBF	1.5 Mc to 0.9 Mc	10.00

### Band Spread Coils

AB-10	— 10 meter band	\$12.00
AB-20	— 20 meter band	10.00
AB-40	— 40 meter band	10.00
AB-80	— 80 meter band	10.00
AB-160	— 160 meter band	10.00

## HFC 56 MC CONVERTER

Type HFC Converter is designed for use on the 28 and 56 MC bands, which are spread over 90 dial divisions. A regenerative detector results in high gain and high conversion efficiency. This, and other features, result in exceptional weak signal response, greatly improve signal-to-noise ratio, and definitely eliminate image frequencies. Isolanite insulation is used throughout the HF circuits except the coil forms, which are moulded R-39.

The output of the first detector is coupled through a high gain I.F. Transformer to a low impedance output coupling tube which insures efficient signal transfer to the antenna circuit of the B.C. Receiver, which should be of the TRF Type. Tubes required: two 24's, one 27 or two 36, one 37.

135 Volts B supply is required, which may be obtained from B batteries or from any of the National Power Units. A filament supply of either 2½ Volts (AC) or 6 Volts (AC or DC) depending on tubes used, is also required. Type HFC Converter, with both 28 and 56 MC Coils, but without tubes or power supply.  
**List Price, \$39.50**

*Shipping weight 18 pounds*

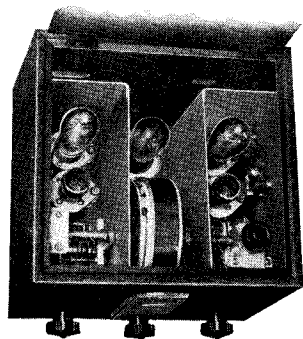

**SCREEN GRID DETECTOR COUPLING UNIT.** This impedance coupling unit, when employed to couple the output of a screen grid detector to an audio amplifier tube, will give from two to three times as much amplification as resistance coupling. Plate choke, 700 henries. Coupling condenser, .01 mfd. Grid leak, 250,000 ohms.  
Type S-101  
**List Price, \$5.50**

## KNOB

This large, 23/8" diameter, fluted knob is standard equipment on the NC-100. It fits 1/4" shafts.  
Type HRK

**List Price, \$.85**



**NATIONAL COMPANY, INC., MALDEN, MASS.**

# NATIONAL RELAY RACKS & POWER UNITS

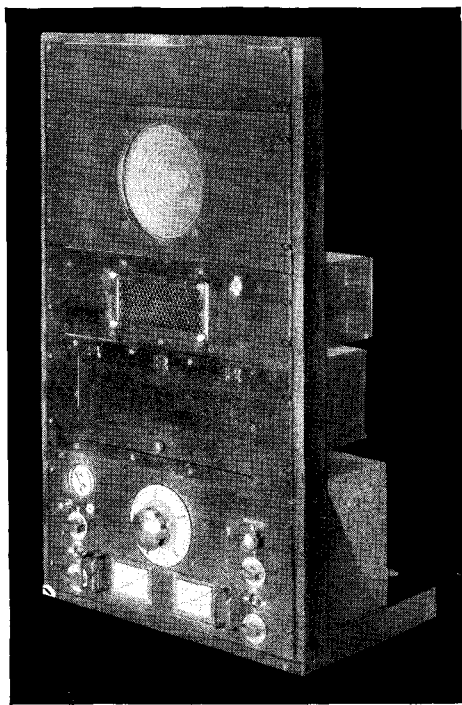

## RELAY RACK UNITS

At the left is illustrated a convenient Relay Rack assembly featuring the HRO. A brief description of the other units follows: (The units are described in order, starting at the bottom of the rack.)

1. The rack illustrated is the small National Bench-type rack, which will receive all standard panels up to its capacity, Type LRR. *Shipping wt. 28 lbs.* **List Price, \$22.50**

2. HRO Receiver, see pages 12 and 13.

3. Coil Rack. A convenient storage space for HRO coils, equipped with a hinged door. Type HCRP.

*Shipping wt. approx. 15 lbs.*

**List Price, \$27.50**

4. Rack mounted packs either single or double, and for either 2½ volt or 6 volt tubes.

Type GRSPU, single. *Shipping wt. 39 lbs.* **List Price, \$49.50**

Type GRDPU, double. *Shipping wt. 48 lbs.* **List Price, \$79.50**

5. This Monitor Speaker Panel employs a dynamic speaker of the permanent magnet type, requiring no power supply. The speaker is mounted on a standard panel (8¾" x 19") and is provided with an impedance matching transformer and connecting cord.

Monitor Speaker Panel, Type RFS. **List Price, \$30.00**

6. Blank Panels, finished in leatherette enamel and made of 3/16" aluminum are available at the following prices:

13¼" wide **List Price, \$3.25**

31½" wide **List Price, 4.50**

51¼" wide **List Price, 5.75**

7" wide **List Price, 7.00**

8¾" wide **List Price, 8.25**

10½" wide **List Price, 9.50**

## STANDARD RELAY RACKS

This six foot rack, built to Government Specifications and drilled and tapped to receive standard panels of all sizes, is of steel, finished in black gloss Duco. Relay Rack, Type RR. **List Price, \$65.00**

## POWER UNITS

National Power Units have exceedingly low inherent hum, employing a double section filter using good quality chokes and ample condenser capacity. The power transformer has an electrostatic shield between the primary and other windings in order to isolate line disturbances. A special R.F. filter is a feature of all National Power Packs designed for short wave use, and is one of several factors contributing to the complete elimination of so-called "tunable hums" frequently encountered in short wave reception.

Power units for National Receivers are equipped with a receptacle for plugging in the power cable from the set and have filament windings specially wound to compensate for voltage drop in the power cable. Proper filament voltage is extremely important, and unless the above power supplies are used, filament voltage should be carefully checked at the socket terminals. For convenience these power supplies are listed with the receivers they are designed for. National also supplies a general purpose power unit. This unit provides four B voltages, the three intermediate taps being adjustable. Voltages are as follows: 22-45V for detector, 45-90V for R.F., 90-135V for A.F., and 180 Volts (35 M.A.) for power tube.

Type 3580, without 80 rectifier tube.

**List Price, \$16.50**

*Shipping weight 17 pounds*

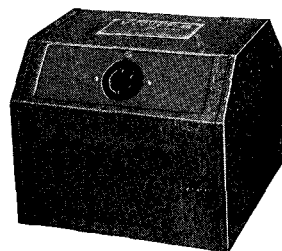
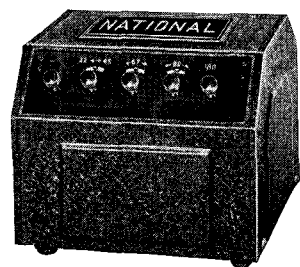

**NATIONAL COMPANY, INC., MALDEN, MASS.**



# PARTS

## VARI-GAP CRYSTAL HOLDERS

This novel holder permits front-of-panel tuning of the crystal over a range of one part in 600 without loss in output. A controlled frequency range of 6 K.C. on the 80 meter band (and if doubling is used, 12 K.C. on the 40 meter band, 24 K.C. on the 20 meter band and etc.) can be expected of this holder when used with a 3550 K.C. Hollister special cut crystal.

The completely enclosed crystal holder is R-39 with 5 contact prongs molded in for handy plug-in socket mounting. All parts in contact with the crystal are chromium plated. A locking device is provided for fixed frequency operation. Altho not shown in the illustration, the holder is supplied with all parts necessary for front-of-panel control; including a six inch length of flexible shafting, connecting hubs, a 0-10 Dial and Knob, and a thru-panel bushing.

Only specially selected zero temperature coefficient crystals should be used for this application as some crystals will not oscillate satisfactorily under the conditions imposed. X and Y cut crystals cannot be used.

Type CHV (without crystal)

Type CHV (with 80 meter Hollister Crystal that will double into the 20 Meter Phone Band)

List Price, \$9.50

List Price, \$32.50

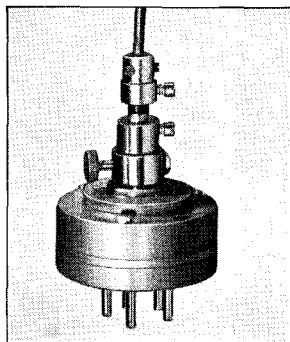

## VERTICAL TYPE CRYSTAL HOLDERS

These holders mount the crystal in a vertical position and crystals may be changed readily. The metal cover is used for protection and shielding only. The holder body is R-39 with two prongs molded-in for easy plug-in mounting. The three models available are as follows:

Type CHR, Resonator type, for use in receivers.

List Price, less crystal, \$2.50

Type CHS, Pressure-Constant Air Gap type, for use in transmitters.

List Price, less crystal, \$2.50

Type CHT, Pressure type (no air gap), for use in transmitters.

List Price, less crystal, \$2.50

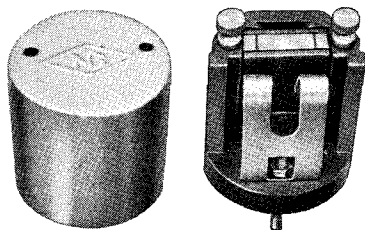

## CATHODE RAY OSCILLOSCOPE

This Oscilloscope gives instantly a graphic picture of operating conditions in your transmitter; such as percentage modulation, signal distortion and peak voltage. The unit is self-contained, power supply and controls are built in. The tube used is the 3 inch diameter RCA-906. An audio signal from the transmitter is used for a linear sweep, as the trapezoid pattern thus obtained is more easily interpreted. The conventional linear sweep may be added at any time. **However, a 60 cycle sweep is provided for use when direct connection to the transmitter is not desired.** A bulletin describing the Oscilloscope in detail will be sent on request.

Type CRO, without tubes

List Price, \$29.50

Tubes required: one RCA-906, one 80. Shipping Weight 23 pounds.

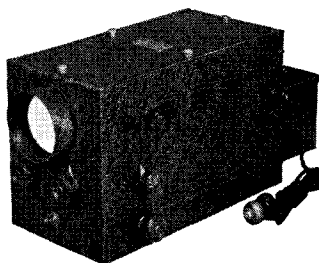

## BUFFER COIL FORM AND SOCKET

At the left below is the Buffer Coil Form Assembly. The Isolantite Coil Form (drilled for leads) is 1 3/4" diameter x 3 1/2" long and may be used as shown or mounted on stand-offs. The upper right figure is the molded R-39 coil plug with five tube prongs for easy wiring and plug-in mounting, designed to be easily attached by two screws to the Coil Form. The Coil Plug may also be used as a base for air-wound plug-in coils, the tube prongs serving as coil anchoring points. The lower right figure is the molded R-39 Socket employing five sturdy side-wipe contacts, three on one side and two on the other for symmetrical wiring of the buffer circuit.

Type UR 13 Buffer Coil Form Assembly  
 Type XR 13 Coil Form only  
 Type PB 5 Plug only  
 Type XB 5 Socket only

List Price, \$2.25  
 List Price, 1.00  
 List Price, .75  
 List Price, .75

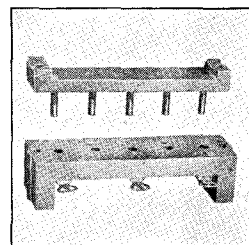
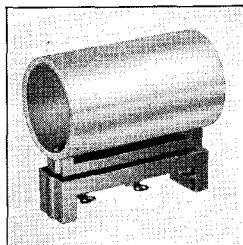

**NATIONAL COMPANY, INC., MALDEN, MASS.**

# H. F. DIELECTRICS

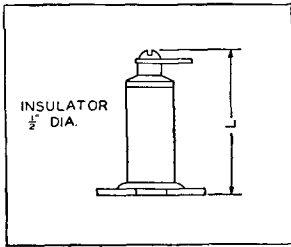

**STAND-OFF INSULATOR.** This well-known little insulator is now offered in two lengths. Long and slender, the larger model is shaped for extreme electrical efficiency. It is an excellent core for H.F. solenoid chokes. (Isolantite)

Type GS-1 (L=1 $\frac{3}{8}$ ") ... List Price, \$ .25  
 Type GS-2 (L=2 $\frac{7}{8}$ ") ... List Price, \$ .35

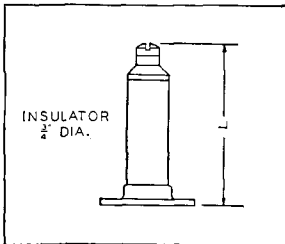
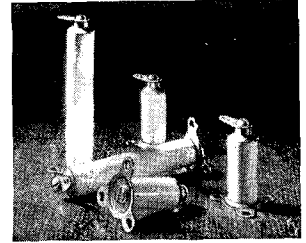

**STAND-OFF INSULATOR.** Metal mounted like the smaller units, these heavy Isolantite stand-offs combine electrical efficiency with strength and convenience. The insulator is  $\frac{3}{4}$ " diameter and is available in two lengths.

Type GS-3 (L=2 $\frac{7}{8}$ ") ... List Price, \$ .80  
 Type GS-4 (L=4 $\frac{7}{8}$ ") ... List Price, \$ 1.00

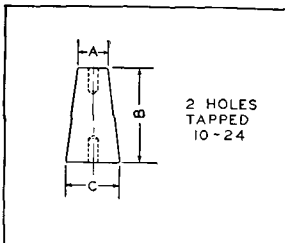
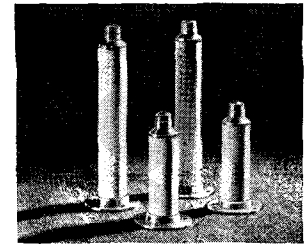

**STAND-OFF INSULATOR.** This popular style of insulator is offered in three sizes, all of low-loss Steatite. The smallest model is tapped 8-32 each end, the larger 10-24.

Type GS-5 (A=1 $\frac{1}{2}$ ", B=1 $\frac{1}{4}$ ", C=1")..... List Price, \$ .25  
 Type GS-6 (A=5 $\frac{5}{8}$ ", B=2", C=1 $\frac{1}{8}$ ")..... List Price, \$ .35  
 Type GS-7 (A=3 $\frac{3}{4}$ ", B=3", C=1 $\frac{1}{2}$ ")..... List Price, \$ .65

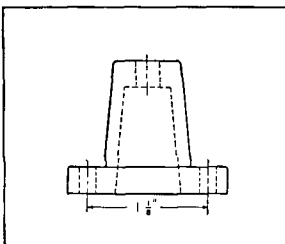

**STAND-OFF INSULATOR.** Another small insulator suitable for a variety of applications. Being made of Steatite, it is eminently suited for Low Loss H.F. circuits. It is available in a special model with a jack for mounting plug-in inductances.

GS-8..... List Price, \$ .25  
 GS-9 (with jack)..... List Price, \$ .35

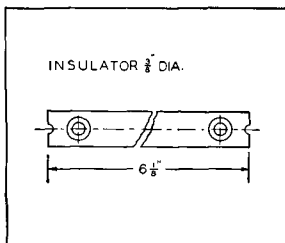
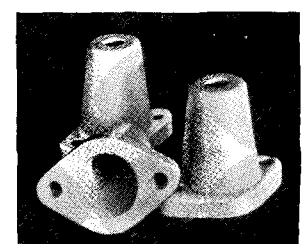

**SPREADER:** The unusual efficiency of these Steatite spreaders will more than justify their slight extra cost. The six inch line spacing when used with No. 12 wire will give feeders having a surge impedance of 600 ohms.

Type AA-3 ..... List Price, \$ .30

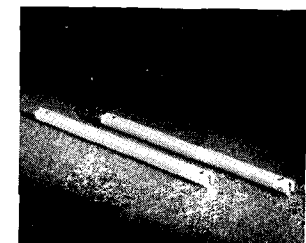

**NATIONAL COMPANY, INC., MALDEN, MASS.**

# H. F. DIELECTRICS

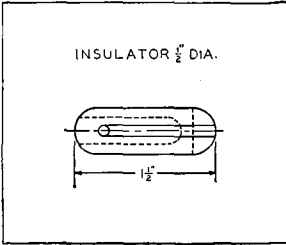

**STRAIN INSULATOR.** This aircraft-type insulator, in spite of its short leakage path, has a variety of uses in small portable, mobile and police installations. Being loaded in compression, the insulator provides great mechanical strength.

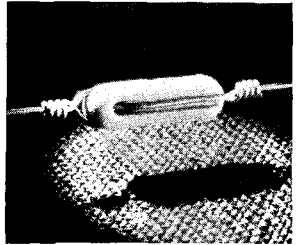

Type AA-5.....List Price, \$ .20

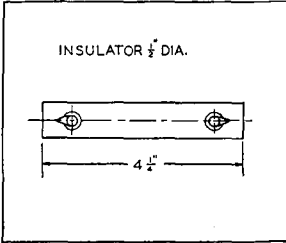

**ANTENNA INSULATOR.** This insulator is particularly suited for general use by the amateur. Its length provides ample leakage path, while its cross-section provides ample strength for all but the heaviest loads. The use of Steatite assures excellent electrical performance.

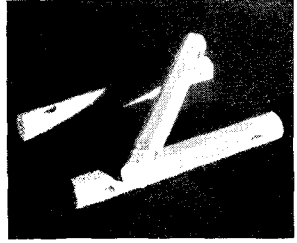

Type AA-6.....List Price, \$ .25

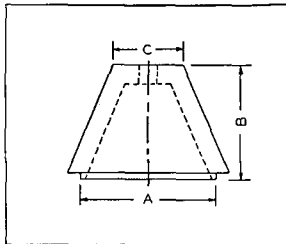

**H.F. BUSHING.** This small Steatite bushing has a variety of uses in transmitter construction, not only as a neat and efficient means of bringing H.F. leads through partitions, but as a support for coils, etc. Each pair of cones includes suitable metal fittings.

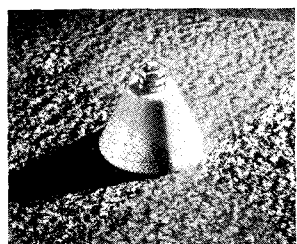

Type XS-1 (A=1", B=1 1/16")  
 per pair.....List Price, \$ .60  
 Type XS-2 (A=1 1/2", B=1 3/16")  
 per pair.....List Price, \$ .80

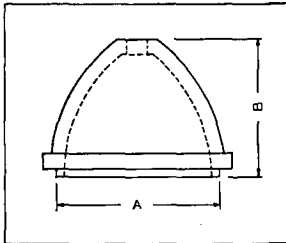

**H.F. BUSHING.** Larger in size than the bushings described above, and shaped to conform to the lines of electrical stress, these Steatite insulators are suitable for higher H.F. voltages. Prices are per pair, with metal fittings.

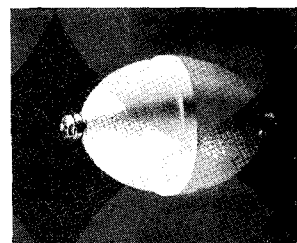

Type XS-3 (A=2 3/4", B=2 5/16")  
 List Price, \$ 3.30  
 Type XS-4 (A=3 3/4", B=2 25/32")  
 List Price, \$ 6.00

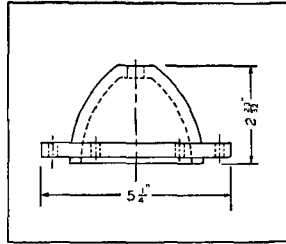

**H.F. BUSHING.** A heavy bowl-type lead-in, suitable for large transmitters, this Steatite insulator provides a weatherproof joint for antenna lead-in purposes. Leakage Path  $3\frac{1}{4}$ ".

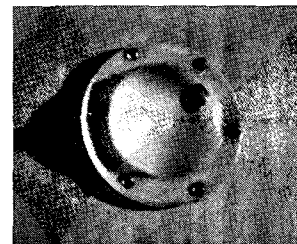

Type XS-5 each.....List Price, \$ 7.50  
 Type XS-5, with fittings, per pair  
 List Price, \$15.50

**NATIONAL**  
 61 SHERMAN STREET



**COMPANY**  
 MALDEN, MASS.

# Aladdin *Presents* GENUINE POLYIRON INDUCTORS

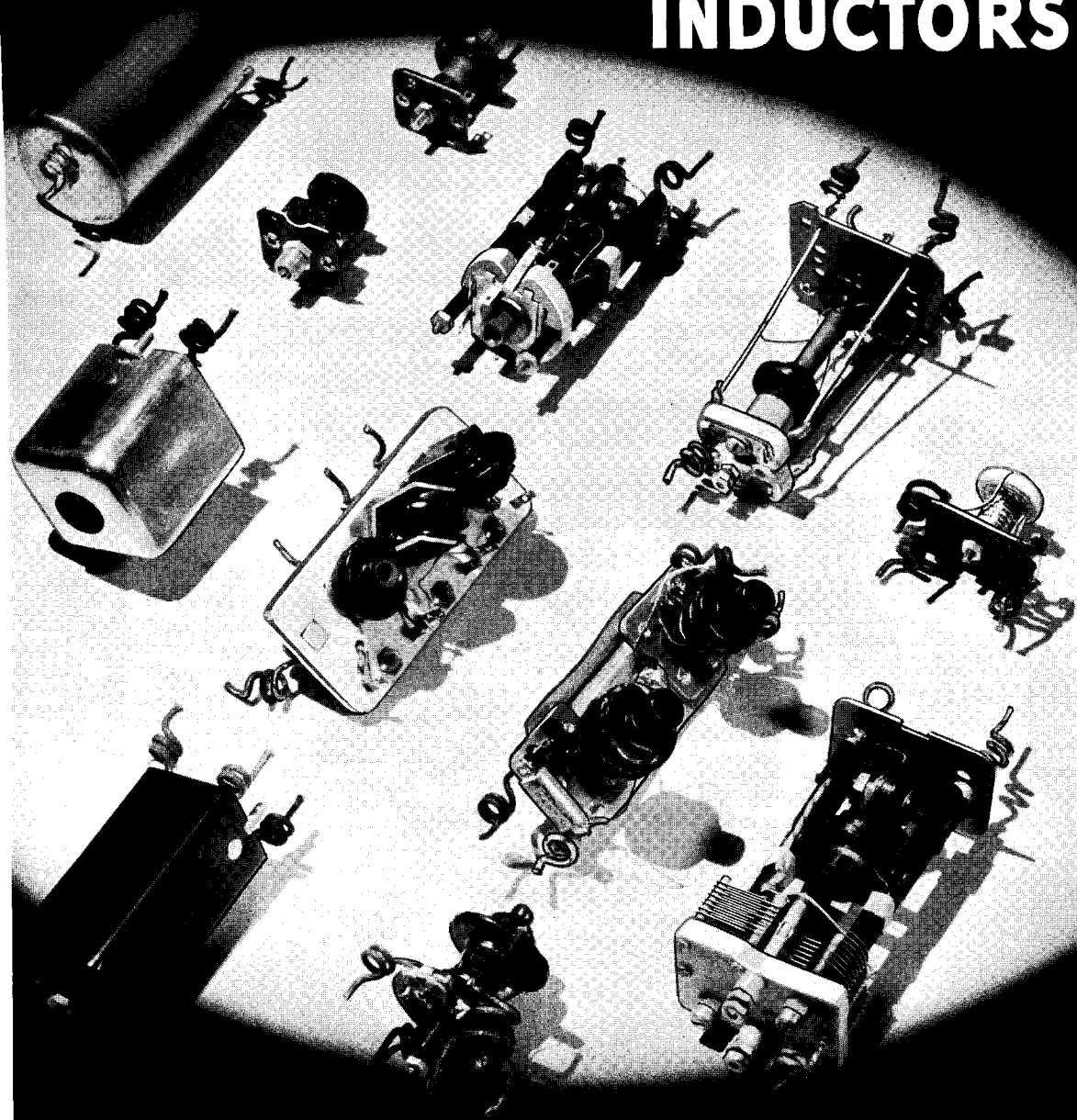

**ALADDIN RADIO INDUSTRIES, INC.**

466H West Superior Street

Chicago, Illinois

Licensee of Johnson Laboratories, Inc.

These devices manufactured under one or more of the following U. S. Letters Patents:  
1887380, 1940228, 1978568, 1978599, 1978600, 1982689, 1982690, 1997453, 2002500  
2005203, 2018626, 2028534, 2032580, 2032914, 2035439. Other patents pending.

## What Is Aladdin Polyiron?

Polyiron is a magnetic material, developed by Johnson Laboratories, Inc., and reduced to commercial application by ALADDIN Radio Industries, Inc., their licensee, in the design and construction of radio-frequency apparatus.

This core material has peculiar properties which differ from solid iron and previous pulverized iron core developments in that it produces an increase in the effective inductance of a coil which is greater than the increase in effective resistance at radio frequencies. At these high frequencies the losses introduced by ordinary iron and other previously known core materials are so high that just the reverse is true; that is, the resistance increase is much greater than the inductance increase. The outstanding properties of this new core material have permitted such remarkable improvements in the design of high-frequency inductors that a new era in radio receiver performance is initiated. The evidence of this improvement is higher gain and greater selectivity secured in these circuits, brought about by the use of ALADDIN Polyiron in the cores of radio and intermediate-frequency coupling devices.

### Increases Inductance

The inductance of any air-core coil may be increased without increasing the number of turns on the coil by merely inserting a small amount of ALADDIN Polyiron in the field of the coil. This phenomenon is familiar to countless radio servicemen who have observed with the ALADDIN Resonator the increase in inductance of a coil, in a receiver which was being aligned, as the Polyiron end of the Resonator was inserted in the coil.

### Decreases Loss

When a coil is wound on an ALADDIN Polyiron core, fewer turns are necessary to secure a given inductance than if the coil did not have a Polyiron core. Since there are fewer turns, less wire is required and the resistance of the winding is less. When employed in a resonant circuit, the inductor having a Polyiron core produces a much sharper resonance curve.

Early in the development of ALADDIN Polyiron the advantages of tuned circuits using a fixed sealed condenser and an inductor provided with an axially movable Polyiron core were recognized. This principle is now being utilized in an improved type of intermediate-frequency transformer and in a new type of wave trap. These units offer remarkable freedom from frequency drift, and eliminate difficulties previously encountered with mica trimmers.

## Aladdin Polyiron Components

ALADDIN r-f and i-f coupling devices utilize inductors consisting of a winding on a Polyiron core, thereby obtaining an advantage over similar devices employing air-core coils or coils with other forms of iron cores. The increased gain and selectivity of ALADDIN devices is shown by the gain figures and graphs on the following pages. An important feature of some of these devices is that various degrees of selectivity may be obtained by a relatively small change in the position of one Polyiron inductor with respect to another. Other ALADDIN devices provide a switching arrangement for varying the selectivity. By choosing suitable units it is possible to obtain the degree of fixed or adjustable selectivity required in a particular receiver.

### Band Expansion

The ability to expand the band width of an i-f system opens many new possibilities to builders of radio receivers. In recent designs incorporating ultra high-frequency reception, selectivity of the order of four kc appears to be necessary. In the broadcast band such extreme selectivity would seriously attenuate the higher audio frequencies, as the side band modulation would be reduced. Band expansion, as provided in several ALADDIN Polyiron transformer designs, successfully meets these new reception requirements.

ALADDIN Polyiron components are made with the utmost care and precision. Every unit is tested on a cathode-ray oscilloscope and held to extremely close tolerances before it is packed for shipment. Even a minor defect is readily detected by these unflinching sentinels of the ALADDIN production testing system.

### Provides Improved Receiver Performance

Leading radio editors and engineers have recognized the value of ALADDIN Polyiron products by describing, in numerous articles, receivers employing these devices. Keen competition in radio receiver sales has forced manufacturers to seek improved performance characteristics for their receivers. ALADDIN Polyiron components offer a solution to their difficulties.

Alert radio servicemen realize the possibilities of selling rebuilt used receivers which have been modernized with sharp-tuning ALADDIN Polyiron components. The pages which follow describe in detail standard types of ALADDIN Polyiron components available to experimenters, amateurs, and radio servicemen through our jobbers at conventional discounts.

Manufacturers are invited to work with our engineers in developing production designs suited to their particular problems in the event our standard units are not directly applicable.

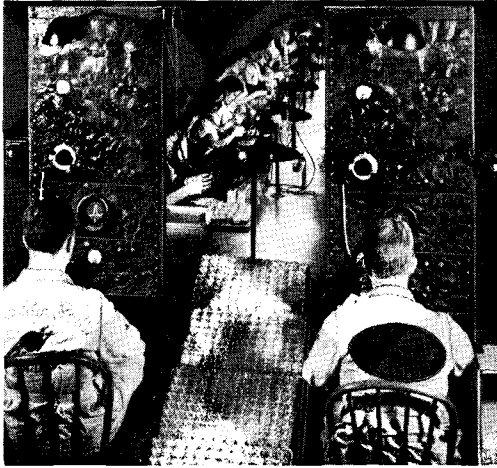

# Aladdin Radio Industries, Inc.

Licensee of Johnson Laboratories, Inc.





# Polyiron Mica-Tuned I-F's

## Type A i-f Transformers

Adjustable coupling, as offered in the Type A ALADDIN Polyiron transformers, permits a desirable degree of circuit variation by the advanced radio technician. A lateral adjustment is provided for the lower coil to secure the exact degree of coupling required for any i-f circuit. In doing this the following procedure should be followed: Loosen the set screws in the bakelite supports, reached through the bottom of the shield; adjust the coupling by carefully turning the nut on the side of the unit. A clockwise rotation of two turns increases the selectivity as shown by A in the accompanying curves, but reduces the gain. A counter-clockwise rotation of two turns produces overcoupling, broadening the curve as shown in C and reducing the gain. B curve is the factory setting at optimum gain.

No factory replacements or adjustments will be made after the lateral coupling seal is broken.

The diagram and table below show three combinations of ALADDIN units for use in a crystal filter circuit.

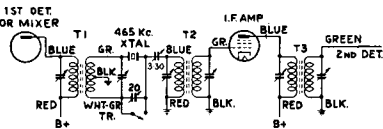

- T<sub>1</sub> G101C or A100C or GA100C
- T<sub>2</sub> G101A A100 GA101A
- T<sub>3</sub> G201 A201 GA201 For Diode 2nd Det.
- T<sub>3</sub> G101A A100 GA101A For Triode 2nd Det.

## Applications

The selection of an ALADDIN transformer should be governed by the types of tubes employed and the gain which the circuit will handle. While 465 kc is the present established i-f frequency, a few transformers are listed for use at other frequencies. The accompanying circuits show tubes corresponding to the types recommended in the data.

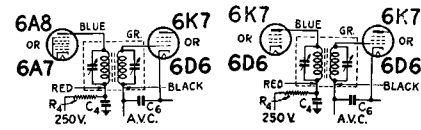

A resistor (1000-1500 ohms) by-passed by a condenser (0.1 uf) appears in the plate circuits. This is recommended because the high gain of Polyiron transformers may cause oscillation if stray coupling exists.

Two stages (three transformers) are not advisable unless a crystal filter is used and then only in a carefully designed circuit. One stage of i-f amplification is ample for the finest receiver.

A typical diode stage (75, 6H6, etc.) shown on the left, working into a 0.5 meg. load (R<sub>1</sub>) may have the following values: R<sub>2</sub>, 0.05 meg; R<sub>3</sub>, 0.5 meg; R<sub>4</sub>, 1000 ohms; C<sub>1</sub>, C<sub>2</sub>, 100 uf; C<sub>4</sub>, 0.1 uf; C<sub>3</sub>, C<sub>5</sub>, 0.05 uf.

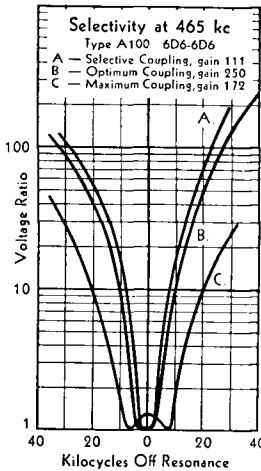
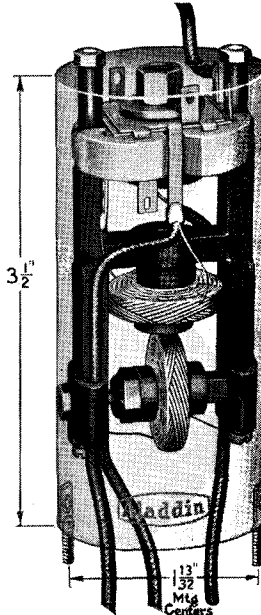
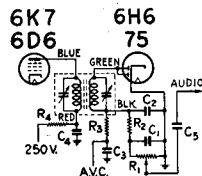

## Specifications and List Prices

Aluminum Shield 1 1/2" D, x 3 1/2" high, 1 13/32" Mtg. Centers

Type	Frequency Range, kc	Factory Setting	Gain	Band Width			Between	Use	List Price
				2x	10x	100x			
A101	440-480	465 kc	50	..	24	82	6A7-6D6	Converter	\$3.00
A101M	440-480	465 kc	48	..	16	56	6A8-6K7	Converter	3.00
A100	440-480	465 kc	250	..	19	66	6D6-6D6	Interstage	3.00
A201	440-480	465 kc	110	13	31	..	6D6-75	Diode	3.00
A200M	440-480	465 kc	113	19	51	..	6K7-6H6	Diode	3.00
A100C	440-480	465 kc	..	..	..	..	-XTAL	XTAL Inp.	4.00
A200C	440-480	465 kc	..	..	..	..	6D6-75	F. W. Diode	4.00
A125	360-380	370 kc	49	..	16	53	6A7-6D6	Converter	3.00
A125	360-380	370 kc	220	..	15	47	6D6-6D6	Interstage	3.00
A225	360-380	370 kc	110	12	31	..	6D6-75	Diode	3.00
A150	250-270	260 kc	62	..	15	54	6A7-6D6	Converter	3.00
A150	250-270	260 kc	330	..	13	41	6D6-6D6	Interstage	3.00
A250	250-270	260 kc	120	11	31	..	6D6-75	Diode	3.00
A175	165-185	175 kc	54	..	11	50	6A7-6D6	Converter	3.00
A175	165-185	175 kc	300	..	9	30	6D6-6D6	Interstage	3.00
A275	165-185	175 kc	135	8	24	..	6D6-75	Diode	3.00
A185	105-125	115 kc	81	..	10	34	6A7-6D6	Converter	3.00
A185	105-125	115 kc	370	..	9	28	6D6-6D6	Interstage	3.00
A285	105-125	115 kc	145	6	18	..	6D6-75	Diode	3.00

## Type G Fixed-Coupling i-f Transformers

An advanced design intended for precision amateur and commercial high-frequency communication receivers, Type G transformers use air-trimmed coils on Polyiron Cores.

The purpose of this design is to provide the utmost freedom from frequency drift in communication-type receivers. Normal temperature changes or variations in humidity have a negligible effect upon air-dielectric trimmers. Type G transformers may be used in circuits of the type shown on page 2.

The use of ALADDIN Polyiron results in a sharper resonance curve and a higher gain than is obtainable with air-core coils of the same physical dimensions.

The increased efficiency of the air trimmers over mica trimmers is evident in the adjacent curves.

## Type GA Adjustable- Coupling i-f Transformers

The adjustable coupling feature of popular Type A ALADDIN Polyiron core i-f transformers is now available with dual air trimmers, in Type GA, suitable for use in circuits shown on page 2.

This design is particularly suited to the needs of the advanced amateur and designers of special equipment, wherein the utmost freedom from frequency drift must be maintained over long periods of time.

In the tabulations below, it may be observed that some items are listed twice with different gain figures. In each case the transformer is the same, the gain and band width changing with various tubes and circuits.

## Type GH Band-Expansion i-f Transformer

Is an air-tuned three-tap band-expansion converter coupler for use in a circuit similar to that shown on page 5 for the H103, where high fidelity may be required for BCL use and extra selectivity for the congested short-wave channels.

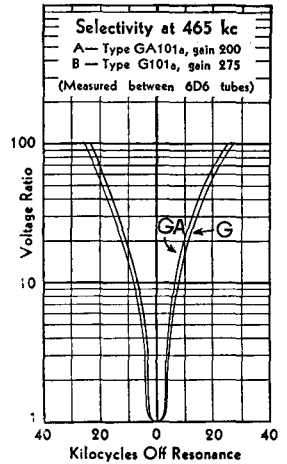
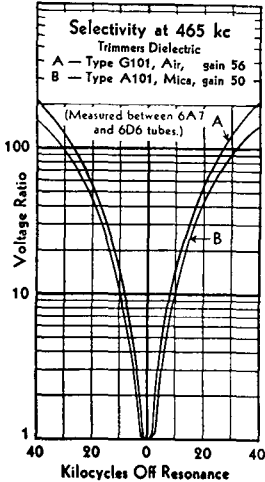
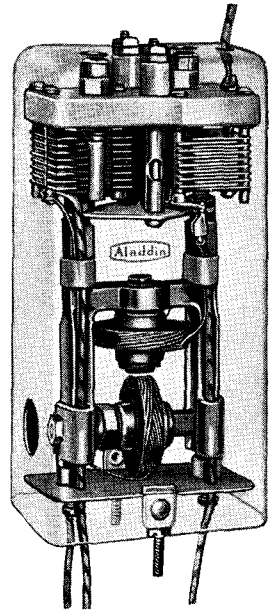
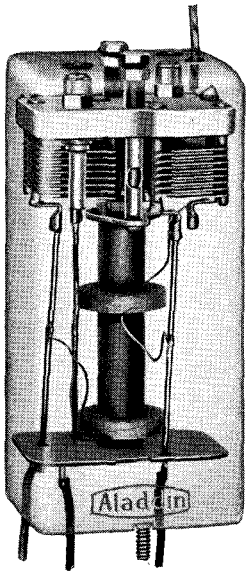

## Specifications and List Prices

Aluminum Shield 1 7/16" x 1 1/8" x 4" high. 1 11/32" Mtg. Centers  
Type G Air-tuned Fixed Coupling

Type	Frequency Range, kc	Factory Setting	Gain	Band Width			Between	Use	List Price
				2x	10x	100x			
G101	456-465	465 kc	56	..	15	57	6A7-6D6	Converter	\$5.50
G101M*	456-465	465 kc	70	..	14	51	6A8-6K7	Converter	5.50
G101A	456-465	465 kc	275	..	17	53	6D6-6D6	Interstage	5.50
G101A	456-465	465 kc	180	..	21	71	6K7-6K7	Interstage	5.50
G201	456-465	465 kc	125	10	29	..	6D6-75	Diode	5.50
G201M†	456-465	465 kc	90	10	29	..	6K7-6H6	Diode	5.50
G208	456-465	465 kc	100	20	..	..	6K7-6H6	Silencer Diode	4.50
G101C	456-465	465 kc	..	..	..	..	-XTAL	XTAL Inp.	6.25
G175	170-180	175 kc	56	..	11	37	6A7-6D6	Converter	5.50
G175	170-180	175 kc	295	..	10	30	6D6-6D6	Interstage	5.50
G275	170-180	175 kc	140	7	19	..	6D6-75	Diode	5.50
Type GA Air-tuned Adjustable Coupling									
GA101	456-465	465 kc	43	..	15	54	6A7-6D6	Converter	6.50
GA101M	456-465	465 kc	52	..	15	49	6A8-6K7	Converter	6.50
GA101A	456-465	465 kc	200	..	15	48	6D6-6D6	Interstage	6.50
GA101A	456-465	465 kc	146	..	17	57	6K7-6K7	Interstage	6.50
GA201	456-465	465 kc	100	13	35	..	6D6-75	Diode	6.50
GA201M	456-465	465 kc	92.5	14.5	42	..	6K7-6H6	Diode	6.50
GA100C	456-465	465 kc	..	..	..	..	-XTAL	XTAL Inp.	7.25
Type GH Air-tuned High Fidelity Converter									
GH103	456-465	465 kc	A-52	..	16	52.5	6A7-6D6	Converter	6.50
			B-60	8	At the nose				
			C43.4	14.5	At the nose				

\*G101M Formerly S2242A.

†G201M Formerly S2242B.

**Type C Midget i-f Transformers**

Type C ALADDIN Polyiron i-f transformers are designed for auto, home, and portable receivers in which space is limited. The Litz-wound coils and low-loss dual mica trimmers are contained in a small copper shield only 2½" high by 1⅛" square.

The gain of Type C transformers in circuits employing metal or metal-glass tubes averages better than the leading types of air-core coils, while the selectivity is distinctly better. Metal tubes have different inter-electrode capacitances from glass tubes; hence, for best performance, accompanying circuit components must be specifically designed to match these tubes. The results achieved with Type C i-f transformers in auto, home, and portable receivers are proof of the value of this careful design in conjunction with metal tubes.

The accompanying performance curves and gain figures are made from average production samples, and are representative of the characteristics of these compact transformers. Circuits using metal tubes, as shown on page 2, right column, are recommended for use with these ALADDIN Polyiron transformers.

Type C350 is a beat-frequency oscillator unit for use in connection with a 6J7 electron-coupled oscillator or an equivalent tube such as the type 6C6.

The accompanying circuit diagram illustrates the method of using the BFO Type C350 unit.

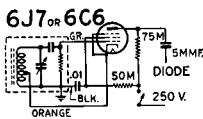
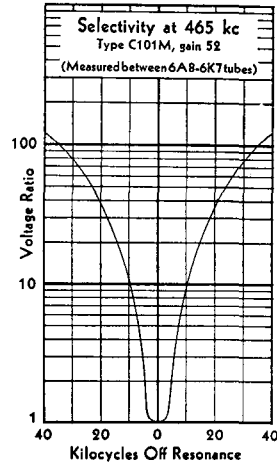
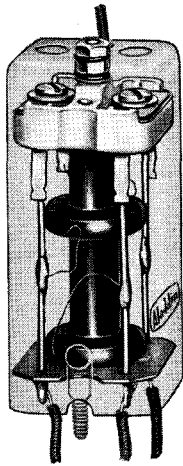

**Type D Constantly Variable** Band Expansion i-f Coupling

Designed for deluxe receivers in which extreme selectivity and optional high fidelity must be instantly available to the user, Type D three-circuit ALADDIN Polyiron i-f coupling devices offer continuous band expansion without substantial loss in gain or departure from a flat-topped steep-sided characteristic.

High fidelity or split-channel selectivity is thus at the option of the user.

Band expansion is accomplished by rotation of the center inductor with respect to the other two inductors, varying the coupling and consequently the selectivity. A standard ¼" shaft projects from the side of the shield can, to which may be attached a flexible extension shaft, an adjustment knob, or a cam and lever control. In the selective position, a Type D coupler will serve to attenuate high audio frequencies by reducing amplification of the higher frequency audio modulation.

The color code designations on the diagram are characteristic of the ALADDIN Polyiron i-f components.

The Type D ALADDIN Polyiron i-f transformer is triple mica tuned and supplied in an aluminum shield 2" x 2" x 4".

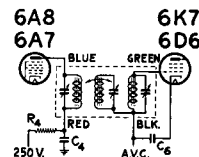
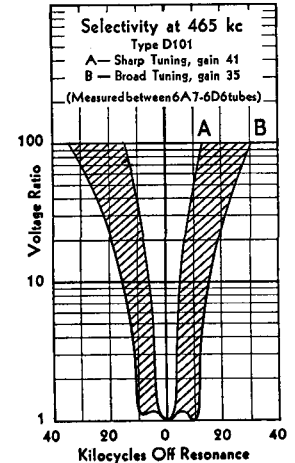
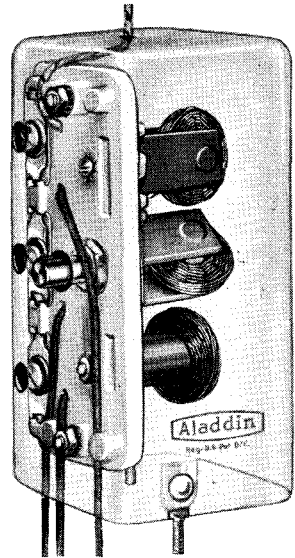

**Specifications and List Prices**

Type	Frequency Range, kc	Factory Setting	Gain	Band Width			Between	Use	List Price
				2x	10x	100x			
C101M	440-480	465 kc	52	..	22	72	6A8-6K7	Converter	\$2.50
C100M	440-480	465 kc	134	..	23	75	6K7-6K7	Interstage Diode	2.50
C200M	440-480	465 kc	95	13	35	..	6K7-6H6	Diode	2.50
C350	440-480	465 kc	..	..	..	..	6J7 or 6C6	BFO	2.50
D101	465	465 kc	A*52	..	15	28	6A8-6K7	Converter	6.50
			B†45	..	32	61			
D101	465	465 kc	A*41	..	12	25	6A7-6D6	Converter	6.50
			B†35	..	32	65			
D200	465	465 kc	A*65	..	19	41	6K7-6H6	Diode	6.50
			B†61	..	31	65			
D200	465	465 kc	A*69	..	18	41	6D6-75	Diode	6.50
			B†74	..	28	64			

A\* — Extreme counter-clockwise position of control shaft.

B† — Extreme clockwise position of control shaft.

## Types P and PH Inductance Tuned i-f Transformers

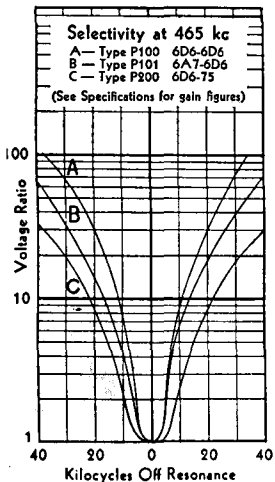

### CIRCUITS

#### P101 Converter

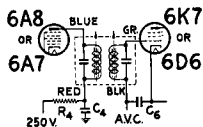

#### P100 Interstage

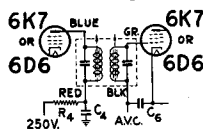

### CIRCUITS

#### P200 Diode

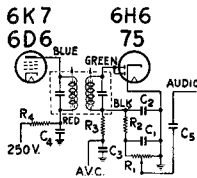

#### PH102

#### Hi-Fidelity Converter

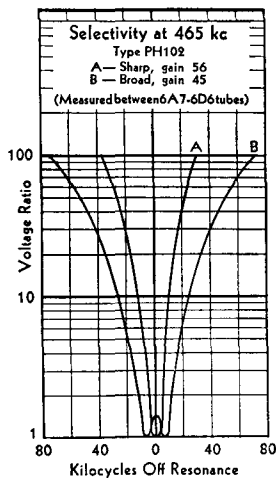
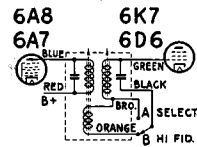

In the above circuits the following constants are recommended:  $R_4$  1000 ohms;  $C_4$  0.1 uf;  $C_6$ , 0.05 uf.

A typical diode (75, 6H6, etc.) stage, shown above, working into a 0.5 meg load ( $R_1$ ) may have the following values:  $R_2$ , 0.05 meg;  $R_3$ , 0.5 meg;  $R_4$ , 1000 ohms;  $C_1$ ,  $C_2$ , 100uf;  $C_4$ , 0.1 uf;  $C_3$ ,  $C_5$ , 0.05 uf.

## Type P Inductance-tuned i-f

In Type P, inductance adjustment replaces the usual condenser trimmers to produce an advanced design i-f transformer. Fixed sealed condensers provide permanency of alignment. Both primary and secondary coils are tuned by adjustment of their Polyiron cores. The Litz-wound coils are on separate axes.

Type P transformers may be used with either glass or metal tubes in circuits such as those illustrated above. When used with the tubes specified in the table the gain and selectivity characteristics shown may be obtained.

Shield 1 7/16" x 1 7/8" x 4" high aluminum. Mtg. centers 1 11/32".

## Type PH-Inductance-tuned Hi-Fidelity i-f

Type PH102 is a two-position band expansion converter unit of the inductance-tuned type for use with either glass or metal tubes. Taps are brought out from a special winding which closely couples the secondary to the primary, to provide either high selectivity or high fidelity in the i-f amplifier as shown by the curves illustrated above. A two-position switch may be used to control the band width from the panel. The gain automatically drops to reduce interference and static encountered in some high-fidelity reception.

Shield 1 7/16" x 1 7/8" x 4" high aluminum. Mtg. centers 1 11/32".

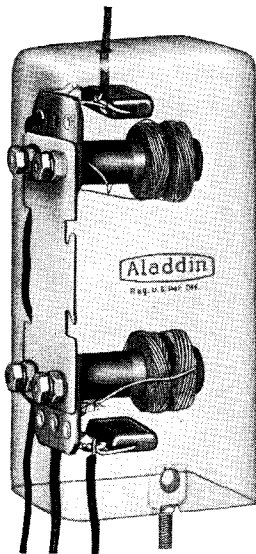

### Specifications and List Prices

Type	Frequency Range, kc	Factory Setting	Gain	Band Width			Use	List Price
				2x	10x	100x		
P101	440-500	465 kc	88	8	25	86	6A8-6K7 Converter	\$3.50
P101	440-500	465 kc	58	8	25	86	6A7-6D6 Converter	3.50
P100	440-500	465 kc	245	7	22	74	6K7-6K7 Interstage	3.50
P100	440-500	465 kc	250	8	22	74	6D6-6D6 Interstage	3.50
P200	440-500	465 kc	73	20	45	..	6K7-6H6 Diode	3.50
P200	440-500	465 kc	93	20	41	..	6D6-75 Diode	3.50
PH102	440-500	465 kc	A-50	7	20	66	6A8-6K7 Converter	4.50
			B-52	24	40	120		
			A-56	7	21	71		
			B-45	24	47	150	6A7-6D6 Converter	4.50

**Type H Hi-Fidelity Band Expansion i-f Transformer**

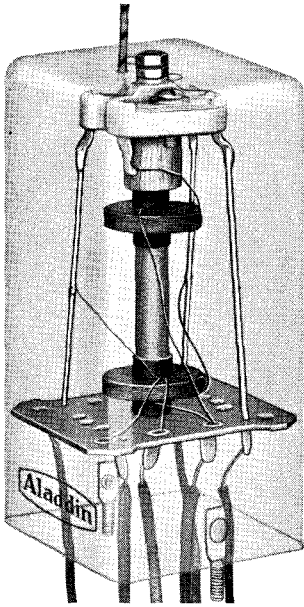

Type H transformers provide optional band expansion in three steps as illustrated in the accompanying curves. The purpose of band expansion is to admit a wide range of carrier-frequency modulation, since it is necessary to pass a band up to 20 kc wide to obtain high fidelity response.

In the Type H103 band expansion converter transformer, taps are brought out from a special winding as shown in the circuit diagram below, to provide a means of over-coupling the unit to secure either high selectivity, medium high or high fidelity. A three-position switch may be used to control the band width of the i-f amplifier from the panel when the Type H103 transformer is used.

ALADDIN Polyiron core coils, quality workmanship, and careful testing insure good performance.

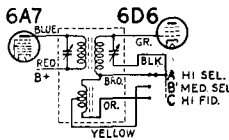
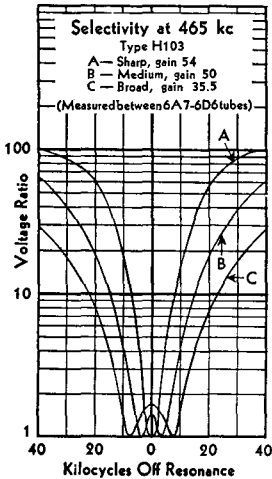

Type H103		Aluminum Shield 2" x 2" x 4" high		Band Width		Use
Frequency Range, kc	Factory Setting	Gain	2x	10x	100x	Between
440-480	465 kc	A-54	..	15	48.5	6A7-6D6
		B-50	..	6.5	At the Nose	Converter
		C-35.5	..	14.3	At the Nose	
List Price..... \$4.50						

**Aladdin Wave Trap**

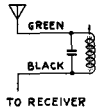
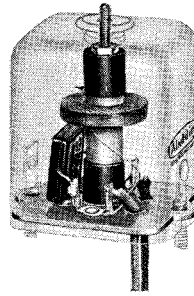

The ALADDIN wave trap is designed to be used in series between the aerial and antenna coil for the rejection of commercial interference at intermediate frequencies. The ALADDIN wave trap is tuned to the interfering signal by varying the inductance of the coil, accomplished by moving the Polyiron core with an adjusting screw.

Type	Frequency in kc	Size	List Price
R4563	440-510 Shielded	1 3/4" x 1 1/2" sq.	\$2.00
R4560	440-510 Unshielded	1 3/4" x 1" x 7/8"	1.50

**Aladdin Choke Coils**

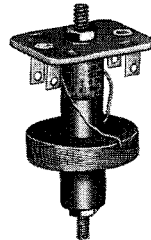

The use of ALADDIN Polyiron adjustable cores in Type K choke coils increases the range of application of these inductors. In experimental work critical values of inductance may be required — a slight movement of the adjustable Polyiron core quickly secures the desired value. Current in excess of 15 ma. is not recommended.

Type	Inductance range in millihenries (approx.)	Factory Setting	List Price
K250	2.1- 2.9	2.5 mh.	\$ .90
K500	4.0- 6.0	5.0 mh.	1.00
K1000	8.0-12.0	10.0 mh.	1.10
K1500	12.5-17.5	15.0 mh.	1.20
K2500	20.0-30.0	25.0 mh.	1.25

**Aladdin Resonator**



A flexible time saving alignment tool. When used with a reliable oscillator and output meter, misaligned circuits are immediately indicated, showing whether an increase or decrease in capacity is needed to align the circuit. Inserting the Polyiron end into a coil has the effect of adding

capacity while the brass end has the effect of reducing the capacity. Proper alignment is indicated when both ends, upon being separately placed in the field of the coil, decrease the output of the receiver. List price with instructions, \$1.00.

**Aladdin Antenna Couplers, r-f Couplers, and Oscillator Coils**

ALADDIN Polyiron antenna couplers are designed for antennae of various capacitances. The different types may be identified by the column entitled "Ant. Cap. in uuf." The uuf column indicates the most suitable antenna capacitance, thus — 75 uuf, an under-car antenna or short indoor antenna; 200 uuf, sedan roof antenna; 300 uuf, 75-foot outdoor antenna as used with home receivers. In selecting an antenna coupler for a particular frequency range, the type of antenna with which it is to be used determines the type of coupler required.

If an unshielded unit is to be used, a slight advantage in gain and selectivity is achieved, but increased care must be taken to avoid stray couplings which will cause oscillation in the circuit.

In the tabulated lists, those devices with special indicating marks following the type number may be used with r-f couplers and oscillator coils designated with similar markings.

The type mounting specified in column 3 of the tables below may be identified as follows, h indicating height:

- u indicates an unshielded coupler
- s indicates a shield 2" x 2" x 3" h aluminum
- r indicates a shield 1 1/2" D x 2 1/2" h copper.

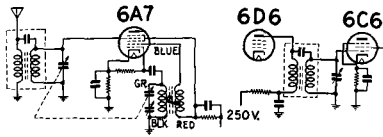
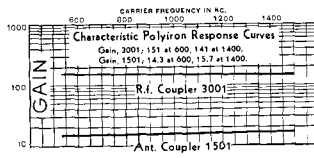
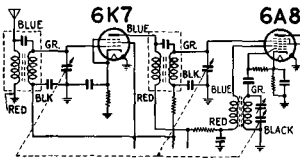
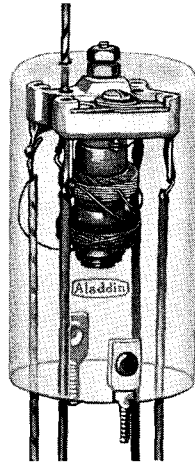
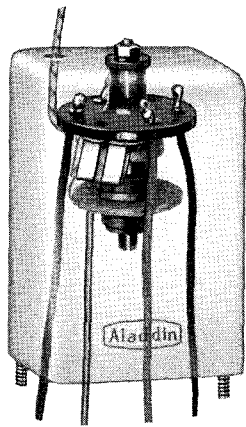

The 6A7 circuit may use any of the 500 series of antenna couplers and the 2000 oscillator coil. The r-f interstage circuit between a 6D6 and 6C6 uses the 1000 series of r-f coils. In this circuit include a 1000-ohm resistance and 0.1 uf. condenser in the plate supply lead to insure stability at high gain.

The 3001 and 2001 coils are recommended for use with the 6L7 and 6C5 metal tubes when preceded by an r-f stage. (Illustrated below.)

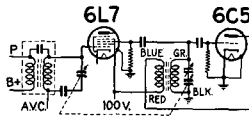

R-f interstage couplers with ALADDIN Polyiron cores are supplied in high-gain types, and matched as indicated to certain types of antenna couplers. The devices in round copper (r) shields are most suitable for auto sets, although somewhat greater gain may be obtained where space permits the use of the square aluminum (s) shields.

Unshielded (u) couplers may only be used in carefully designed circuits where precautions have been taken to eliminate stray couplings. It is not good practice, in any receiver, to use more than one unshielded high-gain unit where circuit stability is desired.

Oscillator coils, for use with adjustable series padder condensers of approximately 400 uuf, are supplied in types suitable for super-heterodyne circuits with 465-kc intermediate frequency when used in conjunction with ALADDIN antenna or r-f couplers.

The frequency ranges indicated in the tabulation below may be obtained with 365-uuf tuning condensers having low minimum capacitance. Band width is measured at 10 times signal input.

All coils are individually tested on a cathode-ray oscilloscope.

**Specifications and List Prices**

Antenna Couplers Type Key	Ant. Cap. Mfg.	Frequency Range in kc	At 1400 kc Gain	At 1400 kc Band Width	At 600 kc Gain	At 600 kc Band Width	List Price
500 #	u 200	530-1500	20.6	142	20.2	40	\$2.00
502 #	u 300	530-1500	25.0	141	27.2	42	2.00
503 #	s 300	530-1500	20.4	140	22.6	43	2.00
504 #	u 75	530-1500	19.3	140	17.6	41	2.00
505 #	s 75	530-1500	15.8	169	13.9	50	2.00
1501 *	r 200	530-1500	15.7	130	14.3	44	2.00
506 †	u 75	550-1725	20.4	135	18.1	39	2.00
507 †	s 75	550-1725	16.5	151	16.2	44	2.00

Date compiled from average production samples.

Interstage Couplers Type Key	For Frequency Use With	Frequency Range in kc	At 1400 kc Gain	At 1400 kc Band Width	At 600 kc Gain	At 600 kc Band Width	List Price
1001 s	#	530-1500	142.0	176	156.0	53	\$2.00
3001 r	*	530-1500	141.0	124	151.0	45	2.00
1006 u	†	550-1725	118.0	158	161.0	50	2.00
1007 s	†	550-1725	99.0	167	140.0	47	2.00
2000 u	#*	530-1500	(Osc. used with 465-kc i.f.)				2.00
2001 r	#*	530-1500	(Osc. used with 465-kc i.f.)				2.00
2006 u	†	550-1725	(Osc. used with 465-kc i.f.)				2.00
2007 s	†	550-1725	(Osc. used with 465-kc i.f.)				2.00

Oscillator coils track with coils of similar key designations.

# RAYTHEON TUBES

FOR THE "Professional" AMATEUR

YOU started communication all over the world with low power on short waves. None of the commercial broadcasting organizations had such a problem — yet, *there was no such thing* as a transmitter tube designed especially for your requirements until RAYTHEON started building them for you!

RAYTHEON led the way with the first transmitting pentode and the first zero bias Class B modulator.

The amateurs who use RAYTHEON tubes are among the record breakers and leaders in amateur transmitting.

RAYTHEON AMATEUR TUBES are built of the finest materials in the world — Tantalum plates, Nonex hard glass bulbs, Isolantite bases, etc. And they are *conservatively rated*.

They are built to give the most output per dollar over the longest time!

Two brand new tubes — just out of the laboratory!

RK-37 High Mu Triode.....	\$8.00	Output 60 W
RK-38 High Mu Triode.....	14.50	225 W

	Output		Output	
RK-10 Triode Power Amplifier Oscillator.....	\$3.50	25 W*	RK-28 R. F. Pentode, \$38.50	200 W
RK-19 Full-Wave High Vacuum Rectifier.....	\$7.50		RK-30 Triode Power Amplifier.....	\$10.00 65 W
RK-20 R. F. Pentode, \$15.00	80 W		RK-31 Zero Bias Class B Mod.....	\$10.00 140 W*
RK-21 Half-Wave Rectifier \$5.00			RK-32 Triode Power Amplifier.....	\$12.00 65 W
RK-22 Full-Wave Rectifier \$7.50			RK-34 Dual Triode Power Amplifier.....	\$3.50 14 W
RK-23 R. F. Pentode, \$4.50	24 W		RK-35 Triode (for Ultra-High Frequencies).....	\$8.00 61 W
RK-24 Triode Power Amplifier (5 Meter Oscillator).....	\$2.25	1.2 W	RK-36 High Output Triode	\$14.50 200 W
RK-25 R. F. Pentode, \$4.50	24 W			

\* Indicates Value for Two Tubes.

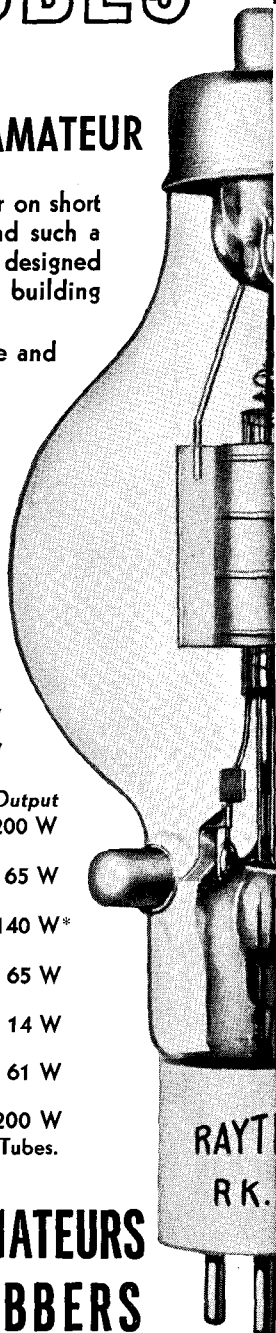

*Used and* **RECOMMENDED BY Leading AMATEURS**  
*Sold* **BY ALL PARTS JOBBERS**

**RAYTHEON PRODUCTION CORPORATION**

445 Lake Shore Dr., Chicago, Ill.  
555 Howard St., San Francisco, Cal.

420 Lexington Ave., New York, N. Y.

415 Peachtree St., N. E., Atlanta, Ga.  
55 Chapel Street, Newton, Mass.

# G-E Transmitter Capacitors

## CAN TAKE IT



EVERY G-E transmitter capacitor will give reliable service and long life. They are treated with Pyranol—General Electric's new, noninflammable, synthetic material—hermetically sealed, and leak-tested under vacuum, assuring permanent operating characteristics, high dielectric strength, and protection against internal breakdown.

You can mount these capacitors in any position; they are small in size and fireproof—just right for your transmitter.

General Electric puts every capacitor through a high-voltage test of double-rated voltage +1000. And we guarantee that you can operate them continuously at 10 per cent above rated voltage.

### STANDARD G-E TRANSMITTER CAPACITORS LIST PRICES\*

MFD. RATING	VOLTAGE RATING								
	500	600	1000	1500	2000	2500	3000	4000	5000
.01	—	—	\$1.80	—	—	—	—	—	—
.05	—	—	1.85	—	—	—	—	—	—
.1	—	—	1.95	—	—	—	—	—	—
.25	—	—	2.00	—	—	—	—	—	—
.5	—	—	2.15	—	—	—	—	\$23.00	\$25.00
1.	\$2.25	\$2.75	3.00	\$3.75	\$5.25	\$14.00	\$18.00	26.00	30.00
2.	—	3.50	4.50	6.25	8.00	17.00	23.00	30.00	34.00
4.	—	4.50	7.00	9.00	11.00	25.00	30.00	—	—
5.	—	5.40	8.00	11.00	13.00	—	—	—	—
10.	—	—	11.00	17.00	19.00	—	—	—	—

\*Discount to amateurs, 40 and 2 per cent.

Get these capacitors from your dealer. We shall be glad to send you our bulletin "Radio Transmitter Capacitors," GEA-2021, giving complete information. Radio Department, General Electric Company, Schenectady, N. Y.

900-3

# GENERAL ELECTRIC



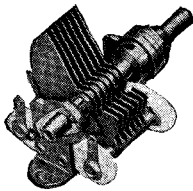

## MC MIDGET CONDENSERS

Ideal variables for ultra-short wave and short wave tuning, laboratories, etc. Isolantite insulation. All contacts riveted or soldered. Vibration proof. New improved Hammarlund split type rear bearing, and noiseless wiping contact. Cadmium plated soldered brass plates. Shaft — 1/4".

CODE	CAPACITY	LIST
MC-325-M	325 mmf.	\$3.50
MC-250-M	260 mmf.	3.00
MC-200-M	200 mmf.	2.75
MC-140-M	140 mmf.	2.50
MC-140-S	140 mmf.	2.50
MC-100-M	100 mmf.	2.25
MC-100-S	100 mmf.	2.25
MC-75-M	80 mmf.	2.00
MC-75-S	80 mmf.	2.00
MC-50-M	50 mmf.	1.60
MC-50-S	50 mmf.	1.60
MC-35-S	35 mmf.	1.50
MC-20-S	20 mmf.	1.40

"M" — Midline Plates

"S" — Straight Line Cap. Plates

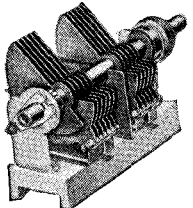

## SPLIT-STATOR CONDENSERS

Like single midgets, these incorporate every requirement imperative to highest quality. Specifications identical to single types except that shield plate is located between stator sections. Also equipped with new Hammarlund noiseless wiping contact and split type rear bearing. Overall length behind panel — 3 1/4". Strong Isolantite base. Single hole panel mount.

CODE	CAPACITY	LIST
MCD-140-S	140 mmf. per sect.	\$4.00
MCD-140-M	140 mmf. per sect.	4.00
MCD-100-M	100 mmf. per sect.	3.50
MCD-100-S	100 mmf. per sect.	3.50
MCD-50-S	50 mmf. per sect.	3.00
MCD-50-M	50 mmf. per sect.	3.00

"M" — Midline Plates

"S" — Straight Line Cap. Plates

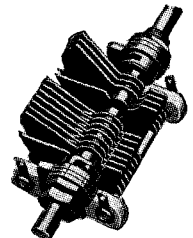

## BAND SPREAD CONDENSERS

For perfect band spreading or for amateur band frequency meters. Tank section may be set and locked to any desired capacity. Tuning section spreads narrow frequency range over entire dial regardless of range of bands or coils used. Tank capacity—100 mmf. Tuning cap. type "120-B"—20 mmf., type "150-B"—50 mmf. Isolantite insulation at front and rear. Plates rigidly held in place.

CODE	LIST
MC-120-B	\$3.00
MC-150-B	3.25

## NEW SHORT WAVE MANUAL



A most valuable short wave guide. Thirty-two pages of important news about short waves with constructional details on the thirteen most popular short wave receivers and power supplies, selected from such leading magazines as QST, Radio News, Radio, Short Wave Craft, and the New York Sun. Each unit has been both tested and further improved in the Hammarlund laboratories.

CODE	LIST
SWM-36	\$1.10

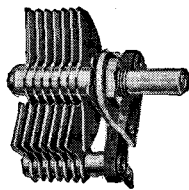

## STAR MIDGET CONDENSERS

For receiving and transmitting; for short wave tuning; regeneration; antenna coupling; vernier, etc. Low loss, natural bakelite insulation. Non-corrosive aluminum plates. Phosphor bronze spring plate affords proper tension and smooth control and also provides perfect contact. Single hole mounting. 1/4" shaft. 5/16" mounting bushings. 19/16" x 1 3/4" high. Depth behind panel from 11/16" to 1/8" depending on capacity. Exceptionally light in weight and strong and compact in construction. Tinned soldered lugs on the front end are supplied to simplify wiring. Plates of straight line capacity type.

struction. Tinned soldered lugs on the front end are supplied to simplify wiring. Plates of straight line capacity type.

CODE	CAPACITY	LIST
SM-15	15 mmf.	\$.85
SM-25	25 mmf.	.85
SM-50	50 mmf.	.90
SM-100	100 mmf.	1.00
SM-140	140 mmf.	1.25
*SM-35-X	35 mmf.	1.00
*SM-50-X	50 mmf.	1.25

\* Double Spaced Transmitting Type.

## MCD DOUBLE SPACED CONDENSERS

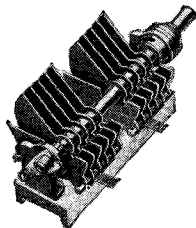

Identical to split-stator condensers except that plates are widely spaced—actual air gap between rotor and stator plates — .0715". No shield between stators. Equipped with new Hammarlund noiseless wiping contact, and split type rear bearing. Condenser ideal for ultra-high frequency transmitters using up to 245's or 210's in push-pull.

CODE	CAPACITY	LIST
MCD-35-MX	33 mmf. per sect.	\$3.50
MCD-35-SX	33 mmf. per sect.	3.50

"MX" — Midline Plates

"SX" — Straight Line Cap. Plates

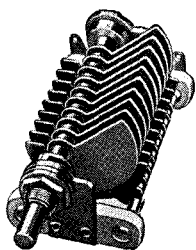

## MCX CONDENSERS

Exceptional unit for ultra-s.w. receivers and transmitters particularly compact transmitters. Plate spacing — .0715". Great for tuning crystal controlled transmitter amplifier stages or for neutralizers up to 210's and 50 watters. In midline (MX) and straight line cap. types (SX).

CODE	CAPACITY	LIST
MC-20-SX	25 mmf.	\$2.00
MC-20-MX	25 mmf.	\$2.00
MC-35-MX	33 mmf.	2.25
MC-35-SX	33 mmf.	2.25
MC-50-MX	50 mmf.	2.75
MC-50-SX	50 mmf.	2.75

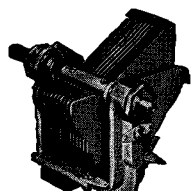

## MIDLINE CONDENSERS

Here is the popular midline condenser which has become a by-word in radio. It has specially shaped brass plates, full floating rotor, removable shaft, perfect bearings and contact, with a rib re-inforced aluminum alloy frame. Isolantite insulation used exclusively. These condensers can be supplied in dual types upon special order. Straight frequency line available on order.

CODE	CAPACITY	LIST
ML-23	500 mmf.	\$4.50
ML-17	350 mmf.	4.25
ML-11	250 mmf.	4.00

## TC TRANSMITTING CONDENSERS

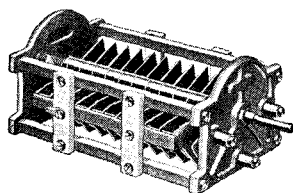

End plates of heavy cast aluminum. Isolantite cross bars. Non-inductive, self cleaning wiping contact. Polished heavy aluminum plates, accurately spaced. Round edged for extremely high voltage work. "A" types — 6500 V — .192" plate spacing; "B" types — 3000 V — .080" spacing; "BX" type — 3500 V — .100" spacing; "X" types — 2000 V — .080" spacing, and "C" types —

1000 V — .038" spacing. Overall width — 4 11/16".

CODE	CAPACITY	LIST
TC-30-A	30 mmf.	\$5.00
TC-50-A	50 mmf.	6.50
TC-100-A	100 mmf.	9.50
TC-150-A	150 mmf.	12.50
TC-225-A	225 mmf.	16.00
TC-100-B	100 mmf.	5.50
TC-150-B	150 mmf.	6.50
TC-225-B	225 mmf.	8.00
TC-335-BX	335 mmf.	12.00
TC-450-B	450 mmf.	12.00
TC-225-X	225 mmf.	6.00
TC-350-C	350 mmf.	5.00
TC-500-C	500 mmf.	5.50

## TCD SPLIT-STATOR TYPES

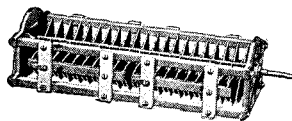

Identical to single types, except that stator sections are individual. With sections in series, breakdown voltage is doubled. "C" types use .038" plate spacing; "X" types — .080" plate spacing, and "A" types — .192" spacings.

CODE	CAPACITY	LIST
TCD-250-C	240 mmf. per sect.	\$8.00
TCD-500-C	500 mmf. per sect.	9.00
TCD-100-X	100 mmf. per sect.	9.00
TCD-225-X	225 mmf. per sect.	11.00
TCD-50-A	50 mmf. per sect.	12.00
TCD-100-A	100 mmf. per sect.	18.00

## APC AIR PADDING CONDENSERS

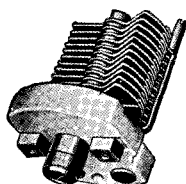

For S.W. and ultra-S.W. For I.F. tuning, trimming R.F. coils or gang condensers, general padding, etc. Constant capacity under any conditions of temperature or vibration. Size 100 mmf. 1 7/32" x 15 1/16" x 1 1/2". Isolantite base. Cadmium plated soldered brass plates.

CODE	CAPACITY	LIST
APC-140	140 mmf.	\$2.25
APC-100	100 mmf.	1.90
APC-75	75 mmf.	1.70
APC-50	50 mmf.	1.50
APC-25	25 mmf.	1.30

## NEW H.F. CONDENSERS

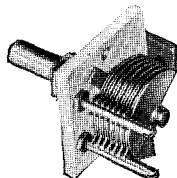

For tuning or trimming on high frequencies. Cadmium plated soldered brass plates. B-100 Isolantite. Base mounting, single hole panel mount, or panel mounting with bushings. 140 mmf. size 1 9/16" high, 1 13/16" behind panel.

CODE	CAPACITY	LIST
HF-15	15 mmf.	\$1.25
HF-35	35 mmf.	1.50
HF-50	50 mmf.	1.60
HF-100	100 mmf.	1.90
HF-140	140 mmf.	2.25
*HF-30-X	30 mmf.	1.85

\* Double-Spaced

## MTC TRANSMITTING CONDENSERS

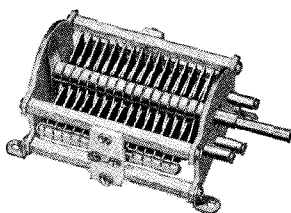

Compact types. Isolantite insulation. Base or panel mounting. Polished aluminum plates. Stainless steel shaft. Size of 150 mmf. with .070" plate spacing only 4 1/2" behind panel. "A" model has .040" plate thickness, all others .025". "A" and "B" models — rounded plates. "C" types — plain plate edges. Self-cleaning wiping contact.

CODE	CAPACITY	LIST
MTC-35-A	35 mmf.	\$5.60
MTC-20-B	20 mmf.	2.85
MTC-35-B	35 mmf.	3.10
MTC-50-B	50 mmf.	3.50
MTC-100-B	100 mmf.	4.60
MTC-150-B	150 mmf.	5.70
MTC-50-C	50 mmf.	2.40
MTC-100-C	105 mmf.	2.65
MTC-150-C	150 mmf.	2.80
MTC-250-C	260 mmf.	3.20
MTC-350-C	365 mmf.	3.60

## MTC SPLIT-STATOR TYPES

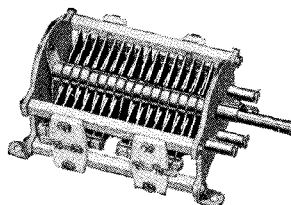

Same outstanding features as MTC singles except that stator sections are separate. Model 100-B with .070" plate spacing, only 5 1/2" behind panel. "B" models — rounded plates. "C" models — plain plate edges.

CODE	CAPACITY	LIST
MTC-20-B	20 mmf. per sect.	\$5.00
MTC-35-B	35 mmf. per sect.	5.50
MTC-50-B	50 mmf. per sect.	6.30
MTC-100-B	100 mmf. per sect.	8.50
MTC-50-C	50 mmf. per sect.	4.10
MTC-100-C	105 mmf. per sect.	4.60
MTC-150-C	150 mmf. per sect.	4.90
MTC-250-C	265 mmf. per sect.	5.70

## H.F. DUAL CONDENSERS

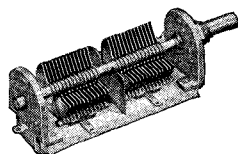

A compact dual — ideal as a high frequency tuning condenser, for tuning and neutralizing low-powered short wave and ultra-short wave transmitters, etc. Heavy B-100 Isolantite base equipped with new outstanding Hammarlund split rear bearing and individual noiseless wiping contact

for each section. Rotor contacts variable to several positions for shortest leads. Shield between sections for grounding. The 140 mmf. size only 1 1/2" high x 3 3/4" long behind panel. 1/4" shaft. Cadmium plated soldered brass plates.

CODE	CAPACITY	LIST
HFD-50	50 mmf. per sect.	\$2.75
HFD-100	100 mmf. per sect.	3.25
HFD-140	140 mmf. per sect.	3.75
*HFD-30-X	30 mmf. per sect.	3.25

\* Double-Spaced

Manufactured by HAMMARLUND MANUFACTURING CO., Inc., 424-438 West 33rd Street, New York

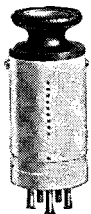

## ISOLANTITE S.W. COIL FORMS

Popular coil form so many fans are using today. Black enameled wooden knob. Removable paper indicating disc protected by celluloid. Surface "non-skid." Plenty of holes — eliminates drilling. Slotted bottom for primary or tickler. Four, five, and six prong types. 1 1/2" diameter. 2 1/2" long exclusive of knobs and prongs.

CODE	LIST
CF-4 (four prongs) .....	\$1.00
CF-5 (five prongs) .....	1.00
CF-6 (six prongs) .....	1.00



## XP-53 COIL FORMS AND KITS

Outstanding forms using new low loss insulation material — XP-53. Natural coloring eliminating losses. Groove ribbed for air spaced windings. Flange grips, meter indexes. Moulded threaded shelf in form. 1 1/2" diameter and 2 3/8" long exclusive of prongs. Kits with wound coils for MC-140 M condenser also available.

CODE	LIST
SWF-4 (four prongs, coil form only) .....	\$.35
SWF-5 (five prongs, coil form only) .....	.35
SWF-6 (six prongs, coil form only) .....	.40

No. 40 coil (wound coil, 4 prongs, 10-20 meters) .....	1.00
No. 41 coil (wound coil, 4 prongs, 17-41 meters) .....	1.00
No. 42 coil (wound coil, 4 prongs, 33-75 meters) .....	1.00
No. 43 coil (wound coil, 4 prongs, 66-150 meters) .....	.75
No. 44 coil (wound coil, 4 prongs, 135-270 meters) .....	.75
BCC-4 (wound coil, 4 prongs, 250-560 meters) .....	1.25
No. 60 coil (wound coil, 6 prongs, 10-20 meters) .....	1.25
No. 61 coil (wound coil, 6 prongs, 17-41 meters) .....	1.25
No. 62 coil (wound coil, 6 prongs, 33-75 meters) .....	1.25
No. 63 coil (wound coil, 6 prongs, 66-150 meters) .....	1.00
No. 64 coil (wound coil, 6 prongs, 135-270 meters) .....	1.00
BCC-6 (wound coil, 6 prongs, 250-560 meters) .....	1.50
SWK-4 (kit — 4, four-prong coils 17-270 meters) .....	3.00
SWK-6 (kit — 4, six-prong coils 17-270 meters) .....	3.75

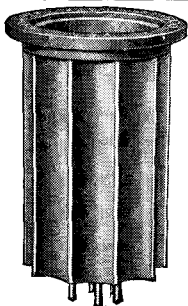

## TRANSMITTING FORMS

Another outstanding coil form for transmitting using that remarkable new low loss insulating material XP-53 dielectric, the same substance that is used for the above coils. Color, also natural. Forms are groove ribbed for air spaced windings. May be permanently mounted on a special pair of brackets supplied with each form, or mounted in the familiar plug-in coil fashion. 2 1/4" in diameter and 3 3/8" long exclusive of prongs.

CODE	LIST
TCF-4 (4 prongs) .....	\$.70
TCF-5 (5 prongs) .....	.70

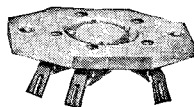

## ISOLANTITE SOCKETS

Standard socket at left. Lowest losses. Constant resistivity. Grippled prongs — cannot shift. Guide groove. Rust-proof side gripping contacts. Glazed top and sides. Sub-panel or base mounting. 2 1/4" x 1 5/8".

CODE	LIST
S-4 (4 prongs) .....	\$.60
S-5 (5 prongs) .....	.60
S-6 (6 prongs) .....	.60
S-7 (large base, 7 prongs) .....	.60
S-7-B (small base, 7 prongs) .....	.60
S-8 (8 prongs) .....	.75

Acorn socket at right. Isolantite. For new high frequency acorn tubes — 954 or 955. 1 1/8" diameter. Five double grip silver plated phosphor bronze prongs. Top, sides, and plug glazed.

CODE	LIST
S-900 .....	\$1.50

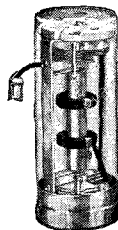
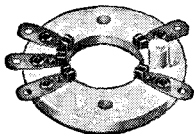

## AIR TUNED I.F.T.

Air tuned primary and secondary units with plate and grid coils or Litz wire. Exceptional "Q" of 115. Coupling co-efficient 0.77%. Gain in excess of 200 per stage together with unequalled selectivity. For 57's, 58's, 94's, 35's, etc. Center tapped units also for split input tubes. Shield 2 3/32" x 5" high.

CODE	FREQUENCY	LIST
ATT-175	175 kc. ....	\$4.50
ATT-465	465 kc. ....	4.50
ATT-175-CT	175 kc. (Center-tapped) ..	4.50
ATT-465-CT	465 kc. (Center-tapped) ..	4.50
ATO	465 kc. (Beat Oscillator) ..	4.50

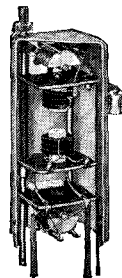

## VARIABLE COUPLING I.F.T.

Outstanding transformers with new variable coupling feature. Approximate range of variation from 1/2 critical coupling to over 3 times critical coupling with circuit constants unaffected. Continuous variation between these limits controllable from panel with coupling mechanism. Thumb screw adjustment where continuous variation is not required. Impregnated 3-ply Litz windings on Isolantite core. Exceptionally high "Q" of 130. 2" x 2" x 5". Transformer without variable coupling feature, minimum coupling also available. Same size as model just described known as ATTS. A beat oscillator type to match this fixed type also available, known as ATOS. CT types, center tapped.

CODE	FREQUENCY	LIST
VT-465	465 kc. ....	\$5.50
VT-175	175 kc. ....	5.50

VT-175	175 kc. ....	5.50
VTC (variable coupling mechanism for panel control of up to 4 transformers) .....		2.00
ATTS-465	465 kc. ....	4.50
ATTS-175	175 kc. ....	4.50
ATOS-465	465 kc. ....	4.50
ATTS-465-CT	465 kc. ....	4.50
ATTS-175-CT	175 kc. ....	4.50

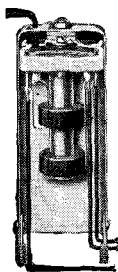

## "T" AND "ST" I.F.T.

For experimental and replacement in superheterodyne midgets, automobile sets, etc. "T" and "ST" type with tuned grid, tuned plate, lattice wound impregnated coils. "ST" type — 2 3/4" high x 1 7/16" square. Type "T" model — 2 1/8" diameter x 3 1/8" high. Type "ST" illustrated at left. Litz wire in 465 kc.

CODE	FREQUENCY	LIST
ST or T-465	465 kc. ....	\$1.45
ST or T-175	175 kc. ....	1.45
ST or T-465-CT	465 kc. (Center-tapped) ..	1.45
ST or T-175-CT	175 kc. (Center-tapped) ..	1.45
ST-262	262 kc. ....	1.45
TBO-465	465 kc. (Beat Oscillator) ..	1.45

## ALUMINUM TUBE AND COIL SHIELDS

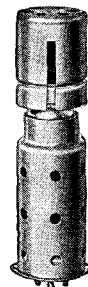

Complete isolation afforded by this tube shield shown at left, for full use of enormous amplification available from new high gain 2.5 and 6.3 volt R.F. pentodes. Special draw-in neck completes shielding between control grid and plate. Removable top entirely shields control grid cap. Body, cap, and base all of heavy aluminum and designed for maximum cooling. Measures 4 5/8" high x 1 27/32".

CODE	LIST
TS-50 .....	\$4.40

The Hammarlund coil shield shown at right is a very effective housing for coils. It is constructed of heavy aluminum and is a 2-piece affair. It is 3" in diameter. Base has mounting holes.

CODE	LIST
CS-3 .....	\$5.00

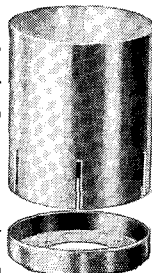

## STANDARD AND MIDGET EQUALIZERS

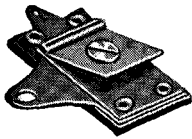

Standard type illustrated at left, popular model for neutralizing, balancing and trimming. Mica dielectric—phosphor bronze flexible plates, bakelite base  $1\frac{1}{4}'' \times 1\frac{11}{16}''$ .

CODE	CAPACITY	LIST
EC-35	3-35 mmf.	\$.30
EC-80	25-80 mmf.	.40

The midget equalizer shown at right is an extremely small condenser designed expressly for trimming R.F. coils, but useful, of course, for many other purposes. Self-supporting in wiring. Isolantite base  $\frac{5}{8}'' \times \frac{3}{4}''$ . Mica dielectric, phosphor bronze spring plates.

CODE	CAPACITY	LIST
MEX	3-30 mmf.	\$.30

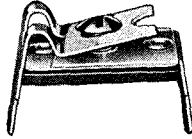

## PADDING CONDENSERS

New improved type. Contains Isolantite base. Most expensive imported mica used. Tested for capacity, power factor, and breakdown at 500 V D.C.  $1'' \times 1\frac{1}{8}''$ . Base mounting centers  $1\frac{1}{4}''$ .

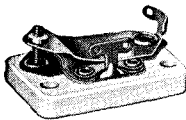

CODE	CAPACITY	LIST
MICS-70	10- 70 mmf.	\$. 50
MICS-140	70- 140 mmf.	.60
MICS-220	140- 220 mmf.	.70
MICS-1000	600-1000 mmf.	1.00

## TRIMMING CONDENSERS



New double Isolantite type with all the outstanding features of the single type. Phosphor bronze flexible plates shaped to provide substantially straight line capacity increase. Constant capacity and power factor maintained under all varying conditions of temperature, humidity, and vibrations. Base  $1\frac{15}{16}''$ . Mounting centers  $1\frac{1}{2}''$ .

CODE	CAPACITY	LIST
MICD-70	10- 70 mmf.	\$. 80
MICD-140	70-140 mmf.	.90
MICD-220	140-220 mmf.	1.00

## FLEXIBLE COUPLINGS

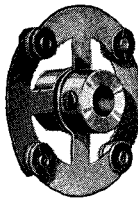

This coupling permits tandem operation of any number of independent units without requiring exact shaft alignment. A great convenience and time saver. The sides of the condenser are insulated from each other, allowing instruments in gang to be operated as independent electrical units. Bakelized canvas with brass bushings for  $\frac{1}{4}''$  shaft. Four rust proofed and hardened steel set screws provide against shafts slipping. Overall diameter  $1\frac{1}{2}''$ .

CODE	LIST
FC	\$.60

## ULTRA S.W. COIL FORMS

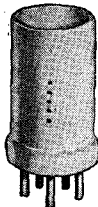

An unusual coil form affording efficiency at ultra-high frequencies or within the 28-56 megacycle band. Isolantite with correct form factor and resultant minimum high frequency resistance guaranteeing absolute stability. Plenty of holes to facilitate any inductance desired and any type of wiring. Form is  $\frac{1}{8}''$  in diameter and 2'' long exclusive of prongs.

CODE	LIST
CF-5-M	\$.75

## HEAVY DUTY CHOKES FOR TRANSMITTING

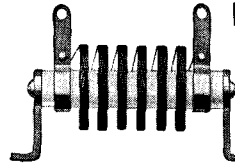

For parallel feed in high powered transmitters—20-40-80- and 160-meter amateur bands. High equivalent impedance more than 500,000 ohms. Effective from 1,500 to 15,000 kc. with exception of frequencies between 5,300 and 6,400 and between 8,000 and 9,000. Six thin universal pies. Isolantite core. Insulated mounting brackets secured to Isolantite core with short machine screws. Brackets removable and choke mounted with a single machine screw. Ind.—2.5 mh. Dist. cap. less than 1.5 mmf. D.C. res.—8 ohms. Max. recommended D.C. (continuous) 500 ma. Overall size, less brackets— $1\frac{3}{16}'' \times 2\frac{1}{2}''$ .

CODE	LIST
CH-500	\$.75

## ISOLANTITE R.F. CHOKES

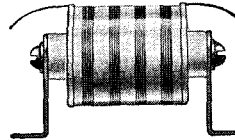

For S.W. and ultra-S.W. receivers and transmitters. Effective over broadcast band too. Recommended as grid choke for multistage transmitters. Isolantite spool. Four sectionalized windings, moisture proofed protected by radio frequency lacquer and cellophane covering. Choke  $1\frac{3}{4}'' \times \frac{7}{8}''$ . Flexible leads. Removable brackets.

Ind.—8 mh. D.C. res.—70 ohms. Dist. cap.—3 mmf. Current carrying cap.—125 ma.

CODE	LIST
CH-8	\$.10

## R.F. SHIELDED CHOKES

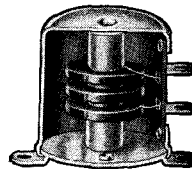

For use in high gain circuits. Universal impregnated wound pies enclosed in an aluminum shield  $1\frac{1}{2}''$  high  $\times$   $1\frac{3}{8}''$  in diameter. Mounting legs on  $1\frac{11}{16}''$  center. Connections to terminal are on one side of the can properly indicated. Inductance—10 mh. D.C. resistance—65 ohms. Current carrying capacity—100 ma.

CODE	LIST
CH-10-S	\$.100

## R.F. HIGH IMPEDANCE CHOKES

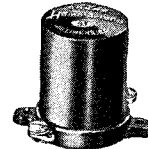

Popular R.F. choke with special impregnated helical winding enclosed in bakelite case,  $1\frac{13}{16}''$  high and  $1\frac{5}{16}''$  in diameter. Ideal for detector plate circuit and R.F. filtering systems in general. Two types—85 mh. with dist. cap. of 3 mmf. and D.C. res. of 250 ohms, and 250 mh. with dist. cap. of 2 mmf. and D.C. res. of 420 ohms. Current carrying cap. of both types 60 ma.

CODE	LIST
RFC-85	\$.20
RFC-250	\$.25

## R.F. MIDGET CHOKES



Invaluable item where space is at a premium. It is so small in size and light weight that it can be supported by own leads. 5 impregnated universal wound pies  $\frac{1}{4}''$  impregnated Isolantite core insuring ruggedness and stability. Ind.—2.1 mh. D.C. res.—35 ohms. Dist. cap.—1 mmf. Current carrying cap.—125 ma. Length across caps  $1\frac{1}{2}''$ . Diameter  $\frac{1}{2}''$ .

CODE	LIST
CHX	\$.60

Manufactured by HAMMARLUND MANUFACTURING CO., Inc., 424-438 West 33rd Street, New York



## THE "SUPER-PRO"

**T**HE Hammarlund "Super-Pro" is a 16-tube superheterodyne designed to meet every rigid precision specification of the professional operator and advanced amateur. It is replete with exclusive distinctive features. Among these are the remarkable new Hammarlund tuning unit with its unusual 5-band silver plated cam switch; 20 individual laboratory adjusted tuning coils on Isolantite bases; complete 4-gang tuning condenser, and a 12-gang band spread condenser — an engineering triumph of compactness and precision! Other outstanding features are — electrostatically shielded input; 2 tuned R.F. stages on all bands; four air tuned I.F. transformers; continuously variable selectivity; high fidelity; three audio stages; visible tuning meter; tuning dial accurately calibrated in megacycles and kilocycles; AVC and Manual gain control; R.F. and I.F. gain control; audio gain control; speaker phone switch; panel control of beat oscillator; separate grid bias supply; C.W. modulation switch, and variable crystal filter. Complete coverage from 20 megacycles to 540 kc. Crystal filter provides selectivity from knife-like point desired for C.W. to a wider degree of selectivity required for practical phone reception. Complete chassis, duo-shield-sealed, thoroughly tropic proofed. The "Super-Pro" receiver consists of two major units — receiver proper and power unit. Receiver in metal cabinet, 18½" wide, 14¾" deep and 10½" high. Power supply in metal cabinet, 13" wide, 7½" deep and 8½" high.

Standard table model "Super-Pro" in wrinkle finished metal cabinet, power supply also in wrinkle finished cabinet, 16 tubes, and matched 8" electro-dynamic speaker..... List \$380.00

Quartz crystal filter model complete in metal cabinets as described above, 16 tubes and 8" speaker. List \$410.00

Rack type, Standard model, complete with dust shields with 16 tubes and 8" speaker..... List \$417.50

Rack type, Quartz Crystal Filter model, complete with dust shields with 16 tubes and 8" speaker. List \$447.50

*Prices cover 110 volt, 60 cycle models. High fidelity 12" speaker available in place of 8" type, at \$25 extra, list.*

Manufactured by HAMMARLUND MANUFACTURING CO., Inc., 424-438 West 33rd Street, New York



# AEROVOX

## CONDENSERS *and* RESISTORS

**T**WO features distinguish the AEROVOX line of radio components: First, thorough engineering to insure satisfactory service. Second, standardized types wherever possible, permitting mass production and resultant low prices.

Which means, from your angle, that you enjoy quality components at prices well within your budget . . . trouble-proof service over years of steady use . . . and, in the final analysis, the lowest cost of operation. It pays to insist on AEROVOX components.



### Oil-Filled X-Mitting Condensers

#### ROUND-CAN TYPE

Genuine oil-impregnated oil-filled paper section in hermetically-sealed aluminum container. Reinforced winding prevents plate flutter. High-tension pillar terminals. No leakage or seepage. Mounting rings. 1000, 1500 and 2000 v. ratings. 1, 2 and 4 mfd. A quality condenser at a bargain price.

#### RECTANGULAR TYPE

For those who prefer the square type. Ideal for compact condenser banks. Selected paper section. Oil-impregnated and filled. Hermetic sealing. High-tension pillar terminals. Mounting lugs. 600, 1000, 1500, 2000 and 2500 v. ratings. 1, 2 and 4 mfd. A striking value. A neat job.



### Other X-Mitting Components

Molded Bakelite mica condensers in 13 different types; also metal-case units. All types of paper condensers. Largest variety of electrolytic condensers. Fixed and ad-

justable wire-wound resistors, fibre strip resistors, carbon resistors, etc. The AEROVOX line meets all your transmitting and receiving requirements.

Send for CATALOG

Just issued. More items. More pages. New low prices. Covers the complete line of condensers and resistors. Also sample copy of AEROVOX Research Worker — the cream of the crop of practical radio data each month. Meanwhile, see your local supplier for AEROVOX components.

# AEROVOX CORPORATION

70 WASHINGTON STREET, BROOKLYN, N. Y.

Sales Offices in All Principal Cities



# THORDARSON the Amateurs' Oldest Friend

**AMATEURS!! Don't be deceived. 38% more copper content does count.**

For 41 years the name Thordarson on a transformer has meant full quality at the fairest price. The largest exclusive manufacturer of radio transformers challenges all competition. Thordarson's workmanship, production and performance have always led. "When better transformers are needed, Thordarson builds them." Because of its full content transformer building policy, "POWERED by THORDARSON" is your guarantee against transformer over-heating, high loss or shorting. THORDARSON builds for the future and is proud of its heritage. Short weight can not make a better value.

## Tru-Fidelity by Thordarson

The result of over 40 years of transformer building, testing and developing is brought to you through this ideal new series of transformers, designed, built and engineered by Thordarson. Tru-Fidelity brings you perfect quality, freedom from stray pick-up, tonal perfection and the famous Thordarson ability to "take it"—and then some!! Send today for Catalog No. 500 or see your parts jobber. Gives complete data, performance curves, uses, mounting features and prices. **FREE TO AMATEURS**

### Tru-Fidelity Uses in P. A. Systems

Send for bulletins S.D.-258, S.D.-259 and S.D.-260. Yes, that P. A. system at the A. R. R. L. Convention in Chicago was powered with Tru-Fidelity by Thordarson.

## Thordarson Complete Radio Transformer Catalog

**Catalog No. 400**

Complete your radio station with Thordarson's big Catalog No. 400, 16 pages chock full of informative data and cataloging. Every standard radio transformer made by Thordarson, America's leading transformer manufacturer, is listed and conveniently indexed. Mounting styles are shown on the back cover to facilitate quick ordering. Write today for your **FREE** copy.

**FOR HAMS, SERVICEMEN and RADIO ENGINEERS!!**

## Thordarson Transformer Manual No. 340

Buy the Big 3 section THORDARSON transformer manual today. Covers the entire field of radio. Section 1, Transmitter Guide No. 344; Section 2, Sound Amplifier Manual No. 346; Section 3 the smashing new Thordarson Servicing Guide No. 342. A thorough treatment of each field covered by these sections is given in this mammoth value. The Transmitter Guide contains numerous practical transmitter hookups. Get on the air with quality and punch. 50c at your radio dealer or send today to the factory for your copy.

**"38% More Copper Content Does Count"**

# THORDARSON ELECTRIC MFG. CO.

**500 W. HURON ST., CHICAGO, ILL.**

*Demand "Power by Thordarson"*

# A Statement of Policy



**T**HE HALLICRAFTERS organization was founded in the belief that there was room for improvement in the design of amateur radio equipment, and a definite need for an adjustment in price levels. We felt that good management and skillful engineering might make this possible.

Ever since the first Sky Rider was introduced several years ago, Hallicrafters receivers have won an increasing acceptance until the organization is now the largest American manufacturer of communications receivers.

We have attained this position by sticking closely to our original aims; maintaining a progressive attitude that is reflected in every Hallicrafters receiver — by constant research and ready acceptance of new and sound developments in radio science.

Because Hallicrafters are fully licensed by all the important holding companies our designing engineers have never been handicapped by patent restrictions in their efforts to create the finest receivers for the amateur radio world.

We feel grateful to the radio amateurs for the widespread acceptance and approval of our policies and ideals. My associates and myself, all licensed amateurs, still feel a thrill of pride when we hear words of praise for Hallicrafters receivers as we work the amateur bands. It is this fine support that is intensifying our efforts to build the finest of receivers at prices that every amateur can afford to pay, and to make it easier for him to own one through our Time Payment Plan.

Sincerely

A handwritten signature in dark ink, appearing to read "W J Halligan". The signature is written in a cursive, flowing style.

PRESIDENT

**the hallicrafters inc.**

2617 INDIANA AVENUE

CHICAGO, U. S. A.



# the ULTRA SKY RIDER

## A Real Step toward Perfect Ultra High Frequency Reception

UNQUESTIONABLY the finest receiver that ever came from Hallicrafters' Precision Laboratories, — a triumph of skillful and ingenious engineering over almost unsurmountable difficulties — the Ultra Sky Rider fills a real need for better reception on the Ultra High Frequency bands. With a built-in Noise Silencer, 1600 KC. Iron-Core Expanding I. F. Transformers, Individual Air-Trimmed R. F. Coils for each of the 4 bands and a dozen other exclusive features, it represents the most advanced ultra high frequency communication receiver available to the amateur today. It pulls in signals from 3.76 to 54.5 meters with amazing clarity and improved phone reception. 19 in. long, 8 $\frac{3}{4}$  in. high, 11 in. deep.



- ★ Built-in Noise Silencer.
- ★ 1600 KC. Iron-Core Air-Trimmed I. F. Transformers.
- ★ Electro-Mechanical Band Spread.
- ★ 338 Degree Dial.
- ★ Direct Calibration Tuning — No Charts or Tables.
- ★ Individual Coils for each band.
- ★ Generous Isolantite Insulation.
- ★ 100 KC. Expansion.

# the SKY RIDER COMMERCIAL

## A "Professional" Type Communication Receiver

*with the Ultra Sky Rider  
it provides complete coverage*

TUNING from 30 to 3000 Meters, the Sky Rider Commercial is an 11 tube Super-heterodyne that can be used for all long wave reception as well as short waves to the 31 meter short wave broadcast band. With the Ultra Sky Rider it provides complete reception of the radio spectrum between 3.76 and 3000 meters, with remarkable sensitivity and selectivity on all bands.

Incorporated in its construction are all the outstanding features that have made the Super Sky Rider so outstanding in its field. It's a thoroughly professional type receiver for the amateur who wants complete coverage. 19 in. long, 8 $\frac{3}{4}$  in. high, 11 in. deep.

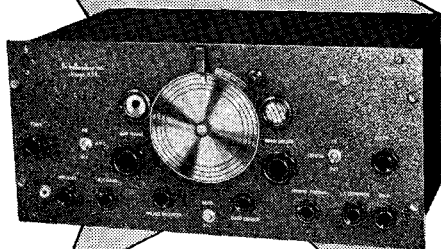

- ★ Micro-Vernier Band Spread.
- ★ Direct Calibration Tuning — No Charts or Tables.
- ★ 1600 KC. Iron Core I. F. System.
- ★ 338 Degree Dial.
- ★ 14 Watts Undistorted Output.
- ★ Field Strength Indicator.
- ★ All Metal Tubes.
- ★ Illuminated Band Spread and Main Tuning Dial.

All HALLICRAFTERS' RECEIVERS now available on time payments through your jobber

# the hallicrafters inc.

2617 INDIANA AVENUE

CHICAGO, U. S. A.

# the SUPER SKY RIDER

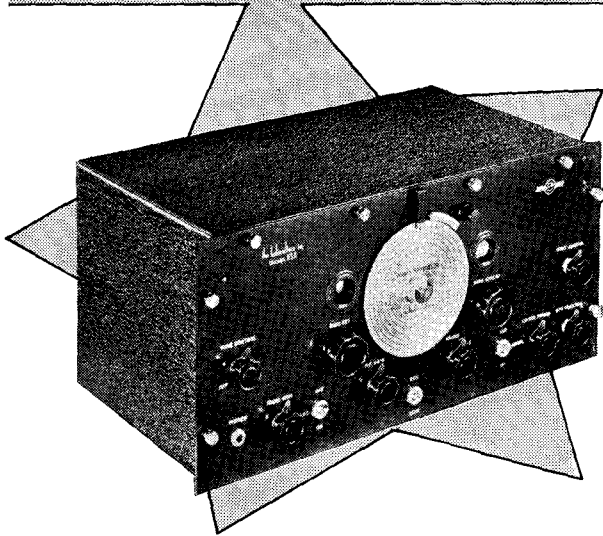

## AMERICA'S LEADING COMMUNICATIONS RECEIVER

These outstanding features make the 1937 SUPER SKY RIDER a leading Communication receiver:

- ★ 11 Tubes, 10 of them metal.
- ★ 40 MC. to 535 KC. in 5 bands.
- ★ 338 Degree main tuning dial.
- ★ Electro-Mechanical Band Spread.
- ★ 14 Watts Undistorted Output.
- ★ Direct Calibration Tuning — No Charts or Tables
- ★ Field Strength Indicator.
- ★ Improved 10-meter performance.
- ★ Single-Signal Crystal Action.
- ★ 465 KC. Iron Core I. F. for improved selectivity.
- ★ Ceramic Insulation.

THE position of leadership held by the Super Sky Rider is justified more than ever by this 11-Tube 1937 Model. Remarkable for its outstanding performance, the many refinements found for the first time in this model place it still farther ahead. Here you have the important developments and features for short wave reception combined in a single receiver at a price that anyone can afford.

The Duo-Micro-Vernier Tuning Dial is now spread over 338° of the 5 band directly-calibrated dial — no charts or tables are required to determine operating frequencies. The micro-vernier feature is unique in that it greatly assists accurate tuning, with a field strength indicator to provide visual tuning as well. The smooth easy action of the dial reduces tuning fatigue.

Finer sensitivity and selectivity, and an improved Signal-to-Noise Ratio as well, are provided by the exclusive use of Iron-Core I. F. transformers, another evidence of Hallicrafters progressive leadership in design. Greatly improved phone reception makes this receiver a pleasure to operate.

The 1937 Super Sky Rider is fully a year ahead — see it at your dealers' or write for complete information. 19 ins. long, 8¾ ins. high, 11 ins. deep.

All HALLICRAFTERS' RECEIVERS now available on time payments through your jobber

the hallicrafters inc.  
2617 INDIANA AVENUE CHICAGO, U. S. A.

# the SKY CHIEF

## Hallicrafters OUTSTANDING NEW 7 TUBE COMMUNICATION RECEIVER

A PRECISION-BUILT Hallicrafters engineered 7-tube superheterodyne with many of the latest features ordinarily found only on much higher priced sets. Tuning from 18 MC. to 545 KC., it is equipped with all the features and controls so desirable to critical operators, and operates with good sensitivity and selectivity. A splendid receiver at an especially attractive price. 17¼ in. wide, 8¾ in. high, 10 in. deep.

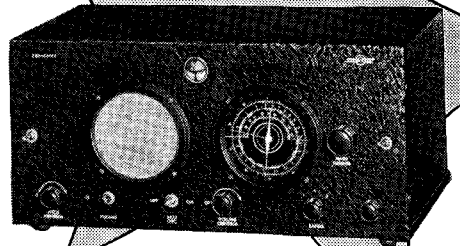

- ★ Single-Stage 465 KC. Iron-Core I. F.
- ★ 18 MC. to 545 KC. in three bands.
- ★ Variable Beat Oscillator.
- ★ Automatic Volume Control.
- ★ Positive 3-Band Selector Switch.
- ★ Mechanical Band Spread.
- ★ Built-in Speaker and Power Pack.
- ★ High-speed Tuning Dial.

# the SKY BUDDY

## A Junior Model Short Wave RECEIVER

*with the performance  
of higher priced receivers*

THIS genuine Hallicrafters engineered communication receiver has amazed many expert operators with its performance. Five tubes do the work of eight in this splendidly engineered superheterodyne, tuning from 18 MC. to 545 KC. in three bands. The Iron-Core I. F. stage provides sensitivity and selectivity excellent for a receiver of this class, while the improved mechanical band spread really "picks them out." A splendid receiver for the beginner in Amateur Radio. 17 in. long, 7½ in. high, 8½ in. deep.

**All HALLICRAFTERS' RECEIVERS  
now available on time payments  
through your jobber**

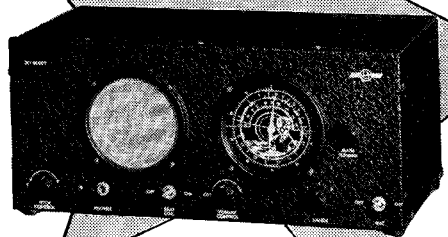

- ★ Combined I. F. and Beat-Frequency Oscillator.
- ★ Iron Core I. F. (High gain — greater selectivity).
- ★ 5 Tubes do the work of 8.
- ★ Automatic Volume Control.
- ★ Greater Band spread — 36 to 1.
- ★ Bands changed with switch.
- ★ Direct-reading calibrated dial.
- ★ Built-in Speaker and Power Pack.

# the hallicrafters inc.

2617 INDIANA AVENUE

CHICAGO, U. S. A.

# ASTATIC

## CRYSTAL MICROPHONES AND PICKUPS

### PUBLIC ADDRESS MODEL D-2

The shape and size of a watchcase

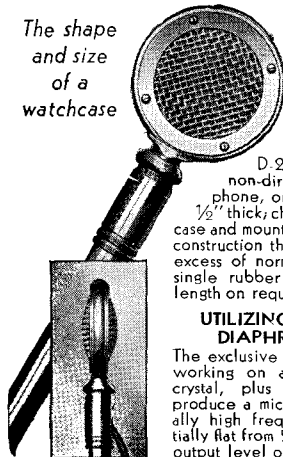

For "top performance" in public address work, the D-2 cannot be excelled. A non-directional, crystal microphone, only 2 1/2" in diameter and 1/2" thick; chromium finish with bronze case and mountings with a ruggedness of construction that will stand shock far in excess of normal. Furnished with 8 ft. single rubber covered cable, longer length on request.

#### UTILIZING EXCLUSIVE DUAL DIAPHRAGM PRINCIPLE

The exclusive Dual Diaphragm principle working on a single grafoil bimorph crystal, plus precision workmanship, produce a microphone with exceptionally high frequency response substantially flat from 50 to 6000 c.p.s. with an output level of -60 DB and absence of microphonics.

#### LIST PRICES OF FOUR AVAILABLE STYLES

- D-2 Microphone without handle..... \$25.00
- D-2H Microphone with handle..... 27.50
- D-2HS Microphone with handswitch..... 28.00
- D-2RS Microphone with relay switch..... 30.00

Send for Bulletin 62 for full details

### "SPEECH RANGE" MODEL D-104

Especially designed for quality performance in the "speech range," the D-104 is the favorite of veteran amateurs the world over. Low in price and built rugged for long service. Case heavy chrome plated; delicate parts suspended within; performance not affected by moving or handling.

#### ASK THE HAM WHO OWNS ONE

Frequency response especially appropriate for amateur work. No background noise. Not easily affected by atmospheric conditions. 3" dia., and 1" thick — equipped with 8 ft. of one-wire shielded rubber covered cable, longer length on request.



#### LIST PRICES FOUR STYLES

- D-104 Microphone without handle..... \$22.50
- D-104H Microphone with handle 25.00
- D-104HS Microphone with hand-switch..... 25.50
- D-104RS Microphone with relay switch..... 27.50

Write for Bulletin 58

## ASTATIC S-TYPE HIGH FIDELITY PICKUP

Astatic Pickups are known the world over for true reproduction of recorded sounds. Where normally records are weakest, in the bass notes, the Astatic Pickup is strongest — not neglecting, also, the brilliant trebles. The Astatic Pickup is about one half the weight on the record as the conventional magnetic type and is therefore extremely kind to the life of recordings.

- Type S-8 for 10 and 12-inch records. List Price..... \$12.00
- Type S-12 for 16-inch records. List Price..... 15.00

Write for Bulletin 60

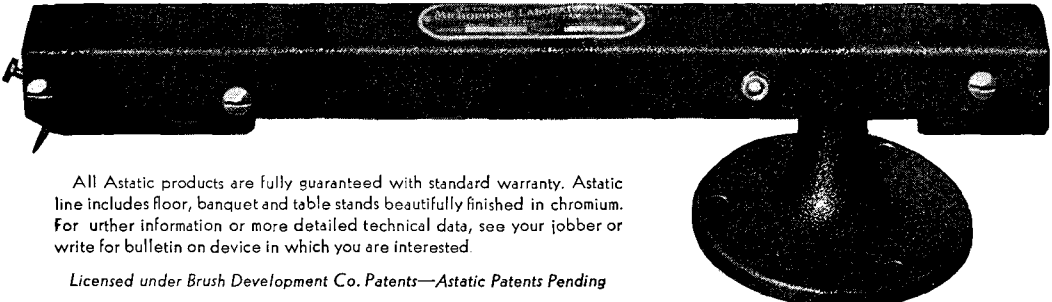

All Astatic products are fully guaranteed with standard warranty. Astatic line includes floor, banquet and table stands beautifully finished in chromium. For further information or more detailed technical data, see your jobber or write for bulletin on device in which you are interested.

Licensed under Brush Development Co. Patents—Astatic Patents Pending

**ASTATIC MICROPHONE LABORATORY, Inc. YOUNGSTOWN, O.**  
*Pioneer Manufacturers of Quality Crystal Products*

## Model 1295 MODULATION MONITOR

Precision  
without  
Extravagance

### ACTUAL PERCENTAGE OF MODULATION SHOWS ON DIRECT READING SCALE

Modulation Monitor Ranges 40 to 120 Per Cent.  
All Readings in Peaks, Factory Calibrated—No  
Further Calibration Needed. Carrier Reference  
Level for Modulation is Read Directly on the  
Second Scale. **Net \$24.83 in U. S. A.**

### TRIPLETT INSTRUMENTS

Triplett Instruments in Your  
Panels Will Give a New  
Conception of Quality.  
Furnished in All Standard  
Sizes and Ranges.

Today's Most Modern  
Instruments. Super-Sensitive  
and Standard.

Molded or Metal Cases.

ALSO  
THERMOAMMETERS — VACUUM TUBE VOLTMETERS  
INSTRUMENT RELAYS AND OTHER RADIO INSTRUMENTS

**AMATEURS**—The New Model 666 Pocket Volt-Ohm-Milliammeter in Black Molded Case with  
A.C. and D.C. Voltage Ranges, D.C. Milliampers, Low and High Ohms Scales,  
Selector Switch for all Readings.

Write for Free Catalog

**THE TRIPLETT ELECTRICAL INSTRUMENT CO.**

666 HARMON DRIVE

BLUFFTON, OHIO, U. S. A.

## EDISON STORAGE BATTERIES

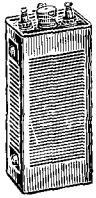

A & B Type



L & M Type

### All Types 1.2 Volts Per Cell

A-6	Amps. 225.	Per cell . . .	\$4.00
A-7	Amps. 260.	Per cell . . .	\$5.00
A-8	Amps. 300.	Per cell . . .	\$5.00
B-4	Amps. 90.	Per cell . . .	\$3.50
M-8	Amps. 11.	Per cell . . .	\$1.00
L-40	Amps. 25.	Per cell . . .	\$1.50
J-3	Amps. 37.	Per cell . . .	\$3.00
A-12	Amps. 450.	Per cell . . .	\$10.00

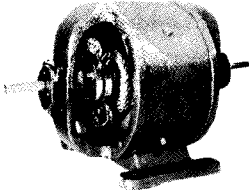

Converters, Wappler, double end shafts, choice of 220 DC to 150 AC or 110 DC to 75 AC, 60 cycle. They may be used as AC generators. Exceptional value.

1 KVA . . . . .	\$35.00
1½ KVA . . . . .	\$45.00
3 KVA . . . . .	\$60.00
5 KVA . . . . .	\$75.00

## DYNAMOTORS



Dynamotor 32/350 volt, ball bearing, 80 mills. Special . . . . .	\$8.00
Per pair . . . . .	\$15.00
24-750 volt Gen. Electric 200 mills . . . . .	\$27.50
24-1500 Gen. Elec. 2½ kw. output . . . . .	\$95.00
12-350 volt 80 mills . . . . .	\$12.00

WE Model 1918 Field Telephone Set, Magneto ringing, Battery talk-

ing. Also used as buzzer phone. Complete with sending key, microphone and headphones . . . . \$10.00

H & H Push-button Momentary Contact (make or break) switch, 250 volt, 10 amp., two circuit, one normally open, one normally closed 50c

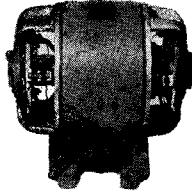

Army dynamotors, Burke, 12 volt to 750 volt, ball bearing. 200 mill output . . . . . \$30.00  
1000 mill output . . . . . \$50.00



Navy Aircraft Dynamotor, Gen. Elec., new 24/1000 volts, 1 amp., extended shaft with pulley, can be driven by motor, or propeller, giving 24 volts output for filament and 1000 volts for plate or driven by its own input of 24 volts. Value \$250.00. Our special price. . \$50.00

## MOTOR GENERATORS

120 d.c., 110 or 220 a.c., 500 cycle, 500 watt . . . . .	\$40 to \$125.00
120 d.c., 110 or 220 a.c., 500 cycle, 1 kw . . . . .	\$75 to \$150.00
120 d.c., 110 or 220 a.c., 500 cycle, 2 kw . . . . .	\$50 to \$150.00
120 d.c., 110 or 220 a.c., 500 cycle, 5 kw . . . . .	\$95 to \$250.00
120 d.c. to 20 d.c. 2 kw . . . . .	\$60.00
120 d.c. to 400 d.c. 2 kw . . . . .	\$45.00
120 d.c. to 600 d.c. 2 kw . . . . .	\$65.00

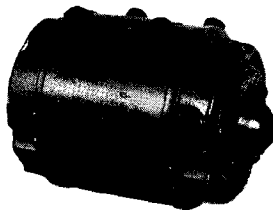

Army converter, Burke, 120 DC to 110 AC, 60 cycle, 100 mill output, small, compact, lightweight . \$7.50

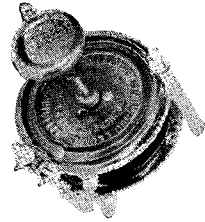

Variable Rheostat, Ward Leonard vitrohms, double plate 8" dia. 5 to 15 amp, 4 ohm, front or back connected, has many uses . . . \$7.50  
Ward Leonard Vitrohms Rheostats. Variable 500 ohm, .2 to 1.5 amp., 35 taps, field regulation type, \$5.00

## CONVERTERS

120 d.c., 120 a.c., 60 cycle, 2 kw. . . . .	\$85.00
Converters, 32 d.c. — 110 a.c., 400 mills . . . . .	\$15.00
Converters, 32 d.c. — 110 a.c., 800 mills . . . . .	\$20.00

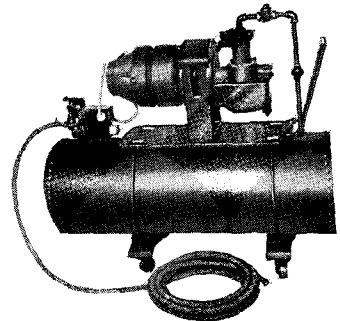

Note these specifications: Large twin cylinder compressor; bore and stroke 1½ in. x 1¾ in., directly connected to G. E. ½ H.P. repulsion-induction heavy duty motor, A.C. 110 volt, 60 cycles, mounted on a 12 x 24 tested steel tank, 150 lbs. pressure, complete with safety valve, check valve, pressure gauge and automatic pressure switch, which can be set to start and stop compressor at any pressure desired. Positive acting, no bells to slip or break and exceptionally quiet in operation. Usually sold at \$85.00 \$39.50

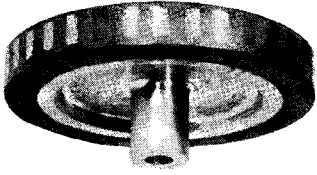

RCA interrupter or tone wheel,  $\frac{3}{8}$ " bore. Uniform brass and insulated segments, complete with copper brushes and holders... \$2.50

### GENERATORS

- 110 volt a.c. 900 cycle, self-excited 200 watts..... \$15.00 to \$35.00
- 120 volt a.c. 600 cycle, self-excited 250 watts..... \$15.00 to \$25.00
- 110 volt a.c. 500 cycle, self-excited 250 watts..... \$25.00 to \$45.00
- 1500 volt d.c. 660 mills, 1 kw. Esco 1750 r.p.m..... \$45.00
- 240 volt 500 cycle, self-excited 2500 r.p.m. 250 watt (also hand drive) \$25.00
- 120 volt d.c. 5 kw. Crocker-Wheeler. \$60.00
- 600 volt d.c. 2 kw. Crocker-Wheeler. \$45.00
- 220 volt a.c. 500 cycle 1 kw. Crocker-Wheeler..... \$45.00 up
- 220 volt a.c. 500 cycle 2 kw. Crocker-Wheeler..... \$60.00 up
- 12 volt d.c. 60 amp. Northeast \$15.00
- 12 volt d.c. 33 amp. Robbins and Meyers..... \$9.00

### METERS

- GE Type DO-14, 3 inch flush mounting voltmeters. D.C. Single scale 0-25..... \$3.50
- Century and Mesco high frequency navy type buzzers..... \$2.00
- Westinghouse oil X-ray transformers, 100,000 volt, 30 milli-amps., 3 KVA, 220 volt, 60 cycle, single phase..... \$90.00
- Bunnell Resistance Box, 1 to 10,000 ohms. A beautiful piece of laboratory or test apparatus. Complete with plugs. Special price... \$15.00

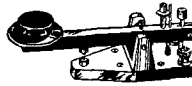

Army Aircraft Type J-3 solid brass transmitting key, large Tungsten contacts, beautiful action, \$1.50  
U. S. Army Morse Key and Sounder — mounted on panel \$1.95

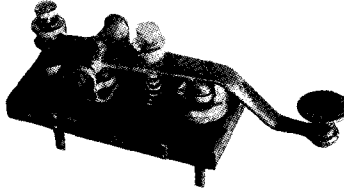

Large Navy 5 K.W. transmitting key, back connected, splendid action,  $\frac{5}{8}$ " heavy silver contacts, \$7.50

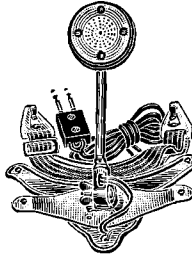

W.E. Breast type carbon microphone, noise proof, complete with cord, plug and breast-plate, exceptional buy..... \$1.95

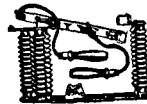

Lightning switch, ceiling type, heavy brass. Can handle 5 K.W. \$4.50

### MINNEAPOLIS HONEYWELL



AC Relay, single pole, double throw, silver contacts, will handle 30 amps. 110 or 220 volt, draws 12 mills..... \$3.50

- Westinghouse Type CX 3" dia. D.C. meters. 0-2 Amperes..... \$3.50
- Voltmeters, D.C. portable new Weston model 45, 3 scale 0-3-15-150 guaranteed  $\frac{1}{4}$  of 1% accurate. \$40.00

- Ammeters, D.C. portable, new Weston model 45, 3 scale 0-1.5-15-150 with 3 scale external shunt and leads,  $\frac{1}{4}$  of 1% accurate... \$30.00
- Army Portable Radio Transmitter and Receiver, Type BC-9 A, \$15.00
- Army Radio Tuner, Type BC-115. \$5.00

- Army Radio Telegraph Tube Transmitter, and Receiver Type BC-32-A..... \$15.00
- Army Amplifier — uses 7 VT-5 (peanut) tubes, Type BC-116-A. \$7.50
- Army Detector and Audio Amplifier, Type BC-101-B..... \$7.50
- Army Radio Amplifier, Type SCR-72, 2 stage..... \$5.00
- GR Type 107-F variable inductor. \$10.00
- GR Type 101-L variable capacitor. \$15.00

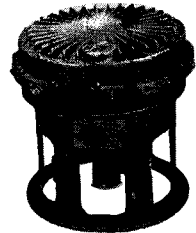

U. S. Navy rotary spark gap, enclosed multiple electrode, high speed, can handle 10 kilowatt.  $\frac{1}{4}$  H.P. 110 v. vertical motor (specify AC or DC)..... \$45.00



### Anti-Capacity Switches

W.E. 12 and 14 Terminals, all with Platinum Contacts, value \$3.50 each. Our price, 95c each.

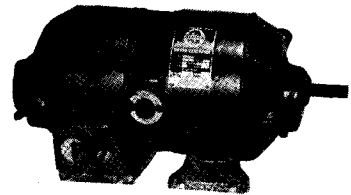

Converters, Dayton, with extended  $\frac{1}{2}$ " shaft. Input 110 AC. Double

current output, 450 volts at 80 mills and 7 volts at 3.75 amp. . . . \$35.00

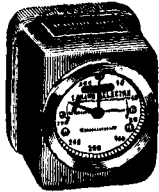

Ampere hour meter, Sangamo, battery charge and discharge. Type MS. 0 to 400 scale, capacity 15 amp. . . . . \$10.00

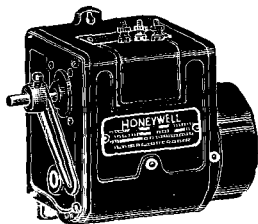

Famous Honeywell furnace heat control motors. Will open and close damper automatically and maintain even temperature when used with thermostat. . . . . \$12.50

With built in switch for operating blower, furnace fan, oil burner, etc. . . . . \$15.00

We also have Blower with motor. \$15.00

Army wavemeter — 150 to 450 meters — with Century high-pitch buzzer and flash-lamp indicator. \$5.00

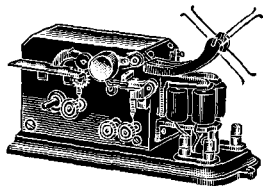

Telegraphic tape register, 2-pen, 10 ohms. May be used to intercept dial phone calls. Has innumerable uses. Used \$15.00. Reconditioned \$20.00

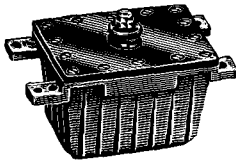

Condensers, Mica, op. volts 12,500, cap. .004 Dubilier, new and used. \$7.50 up

Wireless spec. new and used. \$15.00 up

Condenser, Dubilier, mica, volts 40,000, cap. .0012-.001-.0008 or .003 . . . . . \$10.00

Condenser, Dubilier, mica, volts 8,500, cap. .004. . . . . \$5.00

Condensers, Murdock .002 mfd. 5000 volt. . . . . \$1.00

Westinghouse Type LD oil condensers—3.6 mfd. 3500 v. operating. \$30.00

.47 mfd. 10,000 v. operating \$50.00

Condensers, W. Elec. type 21AA, 1000 volt A.C. test, 1 mfd. . . . \$75

Condensers, Wireless Spec. copper glass leyden jar, 10,000 working voltage, .002 mfd. . . . . \$2.00

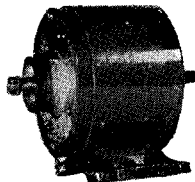

Army AC generator, self excited 900 cycle, 200 watt 110 volt. "Westinghouse." Portable. Every lab. can use one. New. . . . . \$25.00  
Used. . . . . \$15.00

### RELAYS

Relay, low voltage line, cap. 2 amp. 60c each, two for \$1.00. Silver contacts.

Relay West. Elec. low voltage, 2 upper and 3 lower platinum point screws, 3 contact arms. . . . . \$2.50

Relays, West. Elec. types, 122-AB, 122-DH, 149-T, 172-B. . . . \$1.50  
Transformers, G.E. current type, 125 to 2500, with center tap, 60 cycle, 200 watt. . . . . \$7.50

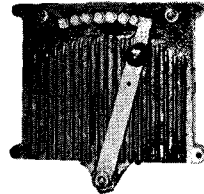

Variable Rheostat, Cutler Hammer, 4 to 12 amp., 6 ohm 10" x 12" \$3.50

Ward Leonard Vitrohm Rheostats. Variable 6 ohm., 15 to 5 amp. battery charging type. . . . . \$3.50

W. E. Telephone Test Set

No. 175-125 W. has large variety of uses. Price . . . . . \$4.50

### SPECIAL

Microfarad meter, Weston portable, model 372, cap. 0002 to .003 volts 220 cyl. 500. . . . . \$85.00

Motors, Universal 1/12 H.P. 110 volt, backgeared, R & M, 2 R.P.M.. \$5.00

Motors, Synchronous, 220 v. 60 cycles 1800 R.P.M. 1/8 H.P., \$10.00

Motors, Synchronous, 220 v. 60 cycles 1800 R.P.M. 1/4 H.P. . . . \$17.00

Relays, W.E. type "E" high res. multi-contact. . . . . \$75

Buzzer phones, model 1914 army, both phone and telegraph, complete, each. . . . . \$5.00

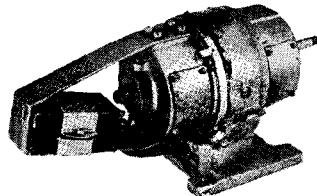

U. S. N. double current generator, 450 volt at 250 mills and 9 volts at 3.75 amp. Complete with filter. May be used as dynamotor. . \$25.00

We have on hand thousands of items, too numerous to mention, suitable for laboratory, shop and experimental use. New items are received daily. A visit to our seven story warehouse will be well worth your while. We invite inquiries on the various pieces of equipment listed on these pages, or on your needs which we can probably supply, at bargain prices, from our immense stock.

**ALL EQUIPMENT UNCONDITIONALLY GUARANTEED FOR ONE YEAR**



# PYREX Radio Insulators

BRAND

## For Amateur Use

**P**ERFORMANCE, which alone has won for PYREX Radio Insulators their present day supremacy, is the direct result of the inherent properties of the glass composition from which they are made.

The high volume and surface resistance and low power loss of PYREX brand glass result in clearer signals and better distance, particularly under adverse conditions.

The perfection of surface of PYREX Radio Insulators is an important factor in preserving their continuous efficiency. Except in heavy storms, rain does not form a continuous film on the surface, and as atmospheric dust particles find no pores or cracks for permanent lodgment, a mild rainfall washes away anything which may have settled on the insulator surface.

A folder describing PYREX Brand Radio Insulators will be sent to you on request.

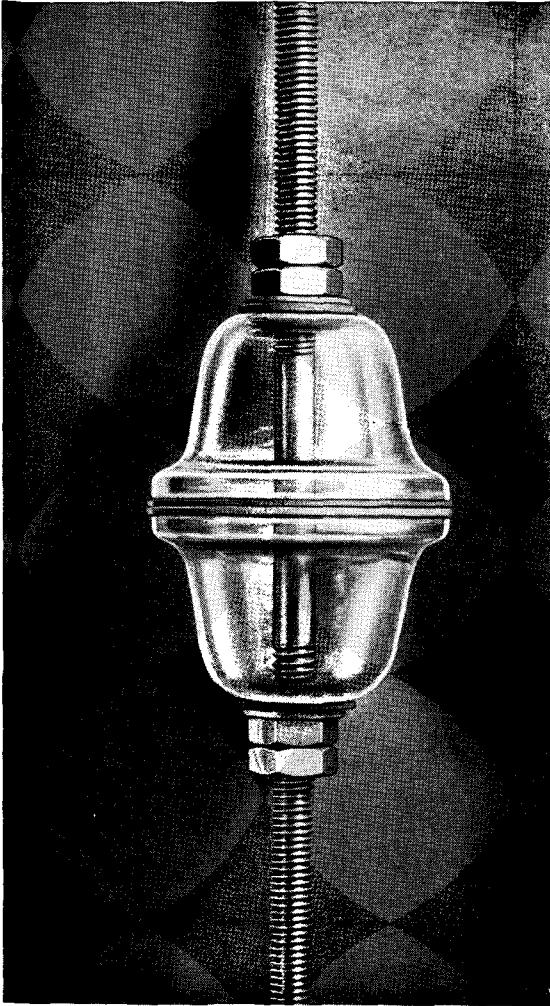

The Perfect Lead-in Insulator—PYREX No. 67104

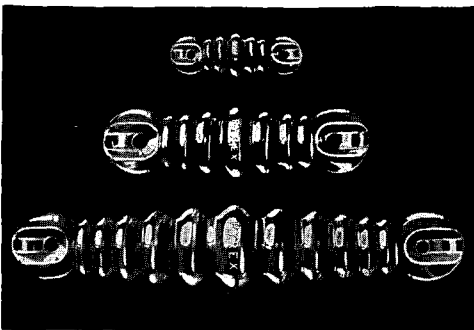

PYREX Nos. 67007-67017-67021 Antenna Insulators for Improved Transmission

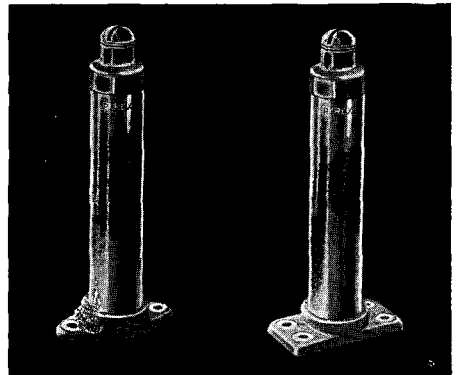

PYREX Nos. 67106-67108 Stand-off Insulators for High Power Transmitters

"PYREX" is a registered trade-mark and indicates manufacture by

**CORNING GLASS WORKS, CORNING, N. Y.**

# CORNELL-DUBILIER

## Condensers

MICA

DYKANOL

THE WORLD'S FINEST

FOR BROADCAST STATIONS

FOR AMATEURS

FOR TELEVISION

... FOR EVERY CONCEIVABLE USE WHERE DEPENDABLE CONDENSERS MUST BE EMPLOYED

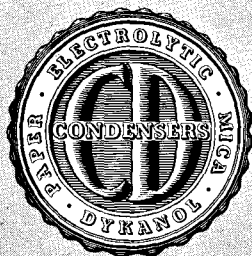

Available at the Nation's Leading Distributors. For a Complete Listing and Technical Story of the C-D Mica and Dykanol Transmitting Condensers Send for Catalog No. 128

Consistently progressive engineering, modern production facilities, a reputation built upon unflinching dependability for more than twenty-six years . . . these are the factors that have made the C-D Condenser line the most popular in the world, among engineers, amateurs and experimenters.

Utilized in every radio transmitting circuit since the earliest days of wireless transmission, C-D Condensers have proven their ability to operate satisfactorily under the most adverse temperature and climatic conditions.

The Complete C-D Line of Capacitors is Available at All Leading Authorized Distributors.

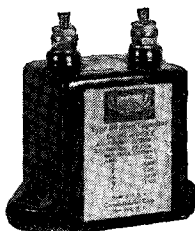

Catalog No. 128 for amateurs and experimenters • Catalog No. 127 for industrial and radio engineers. Supplied free on request.

### TYPE 86 MICA CAPACITORS

High voltage, heavy current-carrying mica transmitting condensers for amateur stations. These condensers have taken the amateurs by storm . . . because of their high efficiency, long-life and low-loss characteristics for Amateur Stations.

Cap Mfd.	Maximum D. C. Voltage	Cat. No.	List Price	MAX. CURRENT IN AMPS			
				15,000 kc 20 M	7500 kc 40 M	3750 kc 80 M	1875 kc 160 M
.00005	12,500	45A-86	\$3.75	3	2.5	1.5	1
.0001	12,500	31A-86	3.75	5	4	3	2
.00025	12,500	325A-86	3.75	7	8	6	4
.0005	7,000	35C-86	3.75	7	8	6	4
.0005	12,500	35A-86	4.25	8	9	8	7
.001	3,500	21D-86	3.75	8	9	8	5
.001	7,000	21C-86	4.25	8	9	10	8
.001	12,500	21A-86	5.00	9	10	11	12
.0015	3,500	215D-86	4.00	8	9	8	5
.0015	7,000	215C-86	4.75	8	9	10	8
.0015	12,500	215A-86	5.50	9	10	11	12
.002	3,500	22D-86	4.25	8	8	9	7
.002	7,000	22C-86	5.25	8	9	10	10
.002	12,500	22A-86	6.50	9	12	13	15
.003	3,500	23D-86	5.00	8	9	9	8
.003	7,000	23C-86	6.00	9	10	10	10
.003	12,500	23A-86	8.00	9	12	13	15
.005	3,500	25D-86	6.00	9	10	11	9
.005	7,000	25C-86	7.00	9	11	12	11
.005	10,000	25B-86	9.50	10	13	14	15
.01	3,500	11D-86	7.00	10	13	14	14
.01	7,000	11C-86	9.50	10	13	15	15
.02	2,000	12E-86	7.00	10	13	15	15
.02	3,500	12D-86	8.75	10	14	16	17
.05	3,500	15D-86	11.50	10	14	17	18
.1	2,000	1E-86	11.00	10	14	17	18

Broadcast stations requiring high voltage, heavy current-carrying mica condensers with which to replace obsolete and defective equipment, or to incorporate into new installations when increasing power, will find a complete range of Cornell-Dubilier condensers available for every circuit requirement.

# THE MOST DEPENDABLE AND COMPLETE CONDENSER LINE

## TYPE 4 MICA CAPACITORS



Designed and developed in the C-D laboratories, these units are highly perfected moulded bakelite condensers that can be mounted in any position. Equipped with heavy solder lug terminals and non-hygroscopic, they are ideally suited for use in power amplifiers and low power transmitters.

Cap. Mfd.	Cat. No.	List Price	Cap. Mfd.	Cat. No.	List Price
<b>Test Voltage 1000 V. D. C.</b>					
.00005	4-6Q5	.35	.00005	4-12Q5	.60
.0001	4-6T1	.35	.0001	4-12T1	.60
.0002	4-6T2	.35	.00025	4-12T25	.60
.00025	4-6T25	.35	.0005	4-12T5	.60
.0005	4-6T5	.35	.0015	4-12D15	.85
.001	4-6D1	.40	.002	4-12D2	.95
.0015	4-6D15	.45	.005	4-12D5	1.50
.002	4-6D2	.45	.006	4-12D6	1.70
.005	4-6D5	.55	.008	4-12D8	2.00
.006	4-6D6	.65	.01	4-12S1	2.35
.01	4-6S1	.80	<b>Test Voltage 5000 V. D. C.</b>		
.015	4-6S15	1.10	.00005	4-25Q5	.70
.02	4-6S2	1.20	.0001	4-25T1	.70
.025	4-6S2	1.45	.0002	4-25T2	.90
			.0005	4-25T5	1.25
			.001	4-25D1	1.50
			.0015	4-25D15	1.95
			.002	4-25D2	2.25

## Type 9 Moulded Mica Capacitors



Constructed to the same precise and advanced manufacturing principles as the type 4, the Type 9 Moulded Mica Condensers have won first ranking honors for maximum efficiency and dependability. Ideally suited as grid or plate blocking, R. F. bypass, and in any other high frequency circuit.

Cap. Mfd.	Cat. No.	List Price	Cap. Mfd.	Cat. No.	List Price
<b>Test Voltage 1000 V. D. C.</b>					
.00005	9-6Q5	\$.40	.0005	9-12T5	\$.70
.0002	9-6T2	.40	.0015	9-12T5	1.15
.00025	9-6T25	.40	.002	9-12D2	1.35
.0005	9-6T5	.40	.006	9-12D6	1.75
.0015	9-6D15	.50	.01	9-12S1	2.80
.002	9-6D2	.50	.015	9-12S15	3.35
.005	9-6D5	.70	.025	9-12S25	4.40
.01	9-6S1	1.15	<b>Test Voltage 5000 V. D. C.</b>		
.015	9-6S15	1.25	.00005	9-25Q5	\$.90
.02	9-6S2	1.85	.0001	9-25T1	.90
.025	9-6S25	2.30	.0002	9-25T2	1.05
.05	9-6S5	3.85	.001	9-25D1	1.50
<b>Test Voltage 2500 V. D. C.</b>					
.00005	9-12Q5	\$.70	.0015	9-25D15	1.95
.0001	9-12T1	.70	.002	9-25D2	2.25
.00025	9-12R25	.70	.004	9-25D4	3.15
			.005	9-25D5	3.35
			.006	9-25D6	3.50
			.01	9-25S1	4.10

## DYKANOL TRANSMITTING CONDENSERS

Dykanol impregnated and filled in hermetically sealed, non-corrosive metal containers, these capacitors can be safely operated at 10% above voltage rating without injury to unit. Convincing evidence of their outstanding quality and dependability is the fact that they are used in the world's largest transmitting stations.

Cap.	Cat. No.	List	H	Dimensions	D
Working Voltage 600 V. D. C. — 440 R. M. S. Rect. A. C.					
1	TJ-6010	\$2.75	2 1/2	1 13/16	1 1/16
2	TJ-6020	3.50	2 2/8	1 13/16	1 1/16
4	TJ-6040	4.50	3 7/16	2 1/2	1 3/16
Working Voltage 1000 V. D. C. — 660 R. M. S. Rect. A. C.					
1	TJ-10010	\$3.00	2 1/2	1 13/16	1 1/16
2	TJ-10020	4.50	4	1 13/16	1 1/16
4	TJ-10040	7.00	4 13/16	2 1/2	1 3/16
Working Voltage 1500 V. D. C. — 1000 R. M. S. Rect. A. C.					
1	TJ-15010	\$3.75	4	1 13/16	1 1/16
2	TJ-15020	6.25	4 5/16	2 1/2	1 3/16
4	TJ-15040	9.00	4 13/16	3 3/4	1 1/2
Working Voltage 2000 V. D. C. — 1500 R. M. S. Rect. A. C.					
1	TJ-20010	\$5.25	3 7/16	2 1/2	1 3/16
2	TJ-20020	8.00	4 1/16	3 3/4	1 3/4
4	TJ-20040	11.00	4 1/16	3 3/4	2 1/4
10	TJ-20100	19.00	4 13/16	3 3/4	4 9/16
Working Voltage 2500 V. D. C. — 1800 R. M. S. Rect. A. C.					
1	TJ-25010	\$14.00	3 5/16	3 3/4	1 3/4
2	TJ-25020	17.00	4 13/16	3 3/4	1 3/4
4	TJ-25040	25.00	4 1/16	3 3/4	4 9/16
Working Voltage 3000 V. D. C. — 2200 R. M. S. Rect. A. C.					
1	TJ-30010	\$18.00	4 1/16	3 3/4	2 3/4
2	TJ-30020	23.00	4 5/16	3 3/4	3 3/16
4	TJ-30040	30.00	4 12/16	3 3/4	4 9/16

The leakage resistance and power-factor change with temperature has been decidedly improved through the utilization of this latest C-D laboratory development, Dykanol "A." It has also been possible to considerably reduce the cubic volume of these units due to the high dielectric strength and constant of this impregnating medium.



The Type TJ series can also be supplied for inverted sub-panel mounting at a slight additional cost.

Cap.	Cat. No.	List	H	Dimensions	D
Working Voltage 4000 V. D. C. — 2750 R. M. S. Rect. A. C.					
1	TJ-40010	\$26.00	5 1/16	3 3/4	2 1/2
2	TJ-40020	30.00	5 1/16	3 3/4	4 9/16
4	TJ-40040	50.00	9 1/16	5 1/2	3 3/4
Working Voltage 5000 V. D. C. — 3300 R. M. S. Rect. A. C.					
1	TJ-50010	\$30.00	4 5/16	3 3/4	4 9/16
2	TJ-50020	34.00	6 1/16	3 3/4	4 9/16

**TYPES 6 AND 15**  
Types 6 and 15 were designed to fulfill the needs of low power

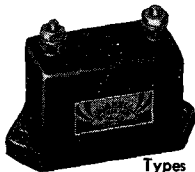

Types 6-15

transmitters, short wave and portable equipment, where size and weight are at a premium.

These types are assembled and hermetically sealed in moulded bakelite cases.

### TYPE 40

Encased in an aluminum casting the type 40 mica capacitor series, utilizes this casting as one of the terminals. The other terminal is insulated by a low loss bushing as illustrated.

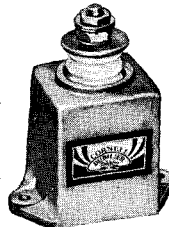

### TYPES 50 TO 59

This series is of improved modern design and has won great popularity due to its adaptability.

Enclosed in ceramic tubing with cast aluminum end terminals these units can be mounted in either a vertical or horizontal plane.

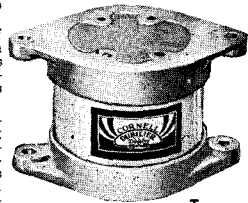

Types 50 to 59

WET AND DRY ELECTROLYTICS • PAPER • MICA • DYKANOL  
SOUTH PLAINFIELD NEW JERSEY

# CORNELL DUBILIER

# QUALITY *Ham* ACCESSORIES

## BIRNBACH TRANSMITTING TUBE SOCKET

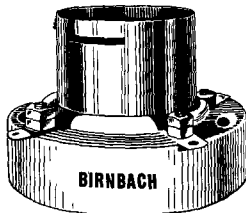

A newly developed Birnbach accessory. The heavy brass shell lends sturdiness to this all important unit — it assures proper support for transmitting tubes. Has phosphor bronze side wiping contacts assuring large area for contact. Highly vitrified low absorption porcelain base.

Cat. No.	List Price
434 — 50 watt.	\$0.90
435 — 210 watt.	1.25

## Transmitter Lead In Insulators

These insulators are used as transmitter and receiver lead in insulators. Made of low absorption, highly vitrified porcelain, each cone is 2 3/4" high. Nos. 4237 and 4238 have sufficient porcelain insulating bushings to insulate the threader rod that goes through partition or wall.



Cat. No.	List Price
4235 Leadin Insulator, 10 in. rod	each \$0.90
4236 Leadin Insulator, 15 in. rod	each 1.00
4237 Leadin Insulator, 10 in. rod with Bushings	each 1.20
4238 Leadin Insulator, 15 in. rod with Bushings	each 1.50
4240 Bushings, 1" long, 3/4" diam.	each .05
4241 Bushings, 1/2" long, 3/4" diam.	each .05
4242 Bushings, 1/4" long, 3/4" diam.	each .05

## STEATITE ANTENNA INSULATORS

Because of their exceptional strength, and exceptionally low moisture absorption, Birnbach Steatite Antenna Insulators are highly recommended. Will withstand strains up to 1500 lbs. The leakage path is long and the cross section is as small as consistent with the strength required. A smooth white glazed finish prevents accumulation of dirt and ice.



No. 470-471

Cat. No.	List Price
470 Steatite Antenna Insulator, 7" Long	\$ .50
471 Steatite Antenna Insulator, 12" Long	.70

## EOI TRANSMISSION CABLE

Because of the unusual construction, this cable can be used in any required length, up to 1000 feet with negligible losses, and can handle any power up to 1 KW. Has a surge impedance of 72 ohms which accurately matches the impedance at the center of the half wave Hertz antenna.



No. 953

Cat. No.	List Price
953 Birnbach E01 Transmission Cable, 1000 ft. coil	\$90.00
954 Birnbach E01 Transmission Cable, 500 ft. reel	45.00
955 Birnbach E01 Transmission Cable, 250 ft. reel	22.50
956 Birnbach E01 Transmission Cable, 100 ft. spool	10.00

## JACKS AND PLUGS

Large contact area — non collapsible. The use of these plugs assures good contact without failure. Preferred by radio amateurs the world over.

Cat. No.	List Price
395 Giant Jack, 3/8" Mounting Hole	Each \$ .25
396 Giant Plug with 10-32 Threaded Hole	Each .25
397 Giant Plug with 1/4-20 Threaded Hole	Each .25
398 Giant Plug, 1/4-28 Threaded Shank	Each .25
399 Giant Jack, 1/2" Mounting Hole	Each .25
400 Plug, 6-32 Threaded Shank, 1/2" Long	Each .06
401 Plug, 6-32 Threaded Hole	Each .07
403 Jack, 1/4" Mounting Hole	Each .06



No. 395



No. 396



No. 398

## Steatite Cone Standoff Insulators

The superior electric qualities of STEATITE make it admirably adapted for use in the manufacture of these Insulators. A complete range of heights having threaded holes and jacks are available.

Cat. No.	Height	List Price
No. 430	3/8"	Each \$0.10
No. 431	1"	Each .15
No. 431J	1"	Each .20
No. 432	1 1/2"	Each .20
No. 432J	1 1/2"	Each .25
No. 433	2 3/4"	Each .25
No. 433J	2 3/4"	Each .50



## Feedthru Standoff Insulators

An original Birnbach development, engineered to meet the requirements of the amateur fraternity. Highly vitrified, smoothly glazed, and properly proportioned to give maximum strength. Minimum breakage because of the cork mounting washers.

Cat. No.	Height	List Price
No. 458	3/8"	Each \$0.12
No. 478	1"	Each .20
No. 478J	1"	Each .25
No. 4125	1 1/4"	Each .25
No. 4125J	1 1/4"	Each .30
No. 4234	2 3/4"	Each .55
No. 4234J	2 3/4"	Each .80



SPECIFY WHITE OR BROWN GLAZE

## Birnbach Standoff Insulators

The same careful process of manufacture is used in all Birnbach products. These insulators range in size from 5/8" to 4 1/2" high, and together with the large assortment of hardware available, every need of the amateur is covered.



966J  
866J  
866SJ  
4275J  
4450J

Cat. No.	Height	List Price
No. 405	5/8"	Each \$0.06 1/2
No. 966	1"	Each .07 1/2
No. 966J	1"	Each .10
No. 866	1 1/2"	Each .12
No. 866J	1 1/2"	Each .15
No. 866SJ	1 1/2"	Each .35
No. 4275	2 3/4"	Each .30
No. 4275J	2 3/4"	Each .55
No. 4450	4 1/2"	Each .50
No. 4450J	4 1/2"	Each .75

SPECIFY WHITE OR BROWN GLAZE



405  
966  
866  
4275  
4450

# BIRNBACH

Radio Company  
145 HUDSON ST.  
NEW YORK CITY · N.Y.

**THIS PLATE  
WAS HOTTER THAN**

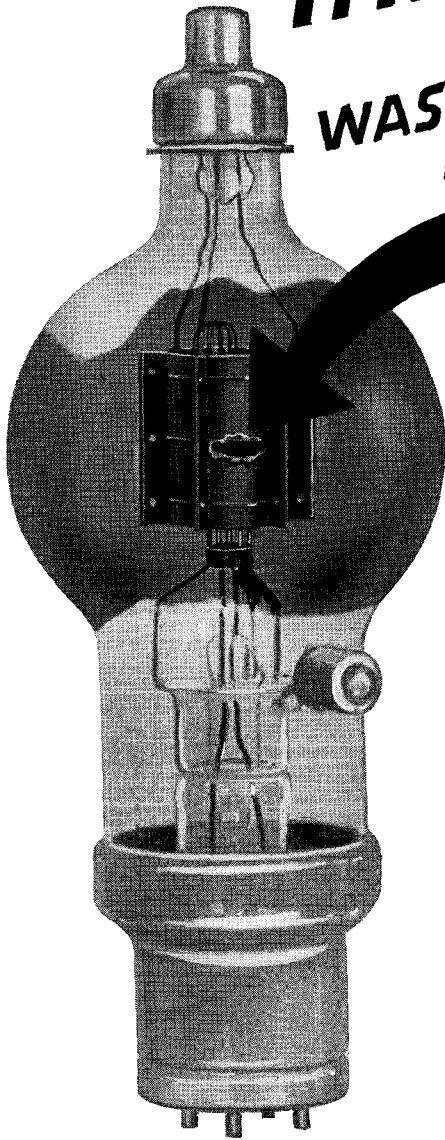

**A FILAMENT OF  
AN INCANDESCENT  
ELECTRIC LAMP!**

3000 watts or 20 times the normal plate dissipation of this EIMAC 150T was necessary to melt this tantalum anode. ● Absolutely no gas was released during this tremendous overload! ● EIMAC exclusive exhausting process permits an unconditional guarantee of complete freedom from gas during tube life.

**PLAY SAFE - BUY EIMAC  
EITEL-McCULLOUGH, INC.**

San Bruno, California, U. S. A.

*At Leading Dealers Everywhere*

# SPEED UP YOUR CODE

**With the Exclusive SOUND Method that  
Developed the CHAMPIONS!**

**TRAINS YOU TO MEET NEW CODE REQUIREMENTS**

## The CANDLER System

**For Years the Dominant Source of Code Training and  
Telegraph Technique!**

This famous SYSTEM is backed by a Quarter Century of Success in training Amateurs and Commercial Operators who could be satisfied only with the best!

You Can Learn Code RIGHT, from the beginning *as you will be using it on the air*, or obtain your commercial license and qualify for a good job by taking CANDLER TRAINING in your own home, as McElroy, Jean Hudson and many others have done and are doing. It is surprisingly easy and inexpensive.



CANDLER Trained T. R. McElroy, World's Official Champion, Class A. Speed 69 wpm.

Champion McElroy says:  
"The CANDLER SYSTEM is the only training I had for my championship code contests. It taught me to read code by sound as easily as I read print, and to put it down on my "mill" by touch, as fast as it comes, without having to think of how words are spelled. Co-ordination and Concentration are necessary to the handling of code at all speeds. The CANDLER SYSTEM in this respect is unique, scientific, exact. I recommend it to those wanting to learn code right, as they'll be using it over the air, and to those who want speed."

CANDLER SYSTEM Taught at HARVARD University by Champion McElroy.

### Which "Ticket" are you going after— Amateur? Commercial?

It takes more than merely the sending and receiving of code to become a skilled radio-telegraph operator. The New CANDLER SYSTEM teaches you quickly the technique of Fast, Accurate telegraphing by simplifying the world-famous principle that has trained many of the outstanding telegraphers and champions during the past quarter century.

### READ CODE AS EASILY AS YOU READ PRINT

CANDLER trained Amateurs and Commercial Operators read code at high speeds, independently of copying, as easily as they read print. They can put it down several words behind, with "mill" or pen, without hesitation or confusion. They transmit at high speeds easily, smoothly, rhythmically, without conscious effort or strain. CANDLER SYSTEM teaches you to *co-ordinate* and *concentrate* automatically. It develops your "Sound-Consciousness" so you can read code at varying speeds with as little effort as you listen to some one talk.

If you are earnest in your desire to learn code RIGHT, to become a skilled Amateur or Commercial Operator, you cannot afford to try and go on without the valuable assistance of CANDLER SYSTEM Specialized Training.



CANDLER Trained Jean Hudson, 9 years old, W3BAK, Official Champion of the World in Class E.

Jean obtained her ham license at the age of 8, and two months after she began Candler SCIENTIFIC CODE and Touch Typewriting Courses, could copy 30 wpm on her "mill." At the age of 9 she won official championship in Class E, against rigid competition.

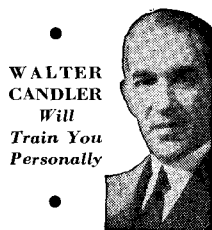

WALTER CANDLER  
Will  
Train You  
Personally

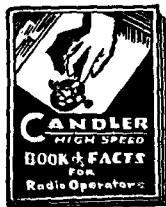

## FREE — New Book of FACTS

Contains McElroy's story, "How I Learned Code" also little Jean's story and information that will aid you in learning code RIGHT or developing championship speed and copying on your "mill" several words behind. If you're "stuck" or need our advice on any phase of learning or handling code, write us. All questions personally answered. No obligation.

**CANDLER SYSTEM CO.** Dept. HB-7  
ASHEVILLE, N. C., U. S. A.

• **WHEN YOU NEED A  
GOOD IRON**

*Demand...*



**Esico Trophy**  
150 Watts  
Tip 7/8" in Dia.  
Weight 18 oz. Length 12 1/2"  
List Price \$5.00

**ESICO!**

When you need a good iron — an iron that stays clean — an iron that stays hot — an iron that you can depend upon — Demand Esico.

Many years of experience in manufacturing electric soldering irons for large radio and industrial companies have produced ESICO — the iron that is "good" because it is built around three factors — **DEPENDABILITY — LONGEVITY — EFFICIENCY.**

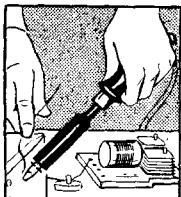

**ESICO STAYS CLEAN**

A special copper drop forged solder tip — produced only after many trials and experiments — stays clean exceptionally long after tinning. The importance of a clean tip is known to us all. The quickly oxidizing iron has caused much annoyance and ruined many an iron. Here is your chance to use a "good" iron that you won't have to clean for every job.

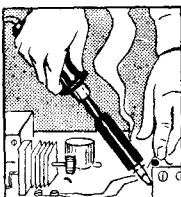

**ESICO STAYS HOT**

The average iron loses a considerable portion of its heat only a short period after it is put into operation. The element and oxidizing causes this difficulty. ESICO has gone a step forward by using **NICHROME V** in the construction of the electric soldering iron element and reducing this factor to a negligible level. "Good" Esico soldering irons give the full wattage rating during their long life.

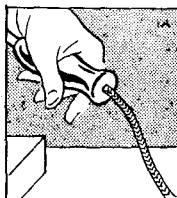

**ESICO DOES NOT FRAY**

Electric cords fraying and shorting cause much inconvenience to many amateurs and in some cases result in physical injury. A special patented method of firmly anchoring a heavily asbestos lined, number 14 electric cord, to the iron proper, entirely eliminates this difficulty.

Many thousands of hams the country over admit the superiority of ESICO. Why not join this increasing army of loyal and well satisfied Esico users?

Electric Soldering Iron Co., Inc.  
342 West 14th St., New York City



**Esico Midget**  
65 Watts  
Tip 7/16" in Dia.  
Weight 7 oz.  
Length 11 1/4"  
List Price \$1.75



**Esico Nick Neck**  
55 Watts  
Tip 7/16" in Dia.  
Weight 6 oz.  
Length 11 3/4"  
List Price \$1.10



**Esico Junior**  
85 Watts  
Tip 7/16" in Dia.  
Weight 9 oz.  
Length 12 1/4"  
List Price \$2.75

*All Esico electric soldering irons are unconditionally guaranteed. A "good" quality iron plus absolute protection assures you of complete satisfaction.*





# Revolutionary Achievement!

## THE Bruno "VELOTRON" A High Fidelity Velocity Microphone

The "VELOTRON" is more than "just another mike" . . . it embodies in a simple and rugged device all the qualities of the various types, eliminating most of their defects and thus becoming the ideal microphone for the amateur and P.A. fields.

Based on a new construction principle, the "Velotron" retains the high fidelity of the Velocity Dynamic microphone, surpasses the output of the diaphragm type Crystal — and is at moderately priced as a good carbon "mike." Being completely shielded and not requiring a transformer, the "Velotron" will not pick-up stray r.f. currents, thus obtaining humless operation. Inasmuch as temperatures, barometric conditions and high winds will not affect the "velotron" it is ideally suited for outdoor transmission.

The unique design of this ultra-modern microphone makes high-fidelity operation over the entire frequency range a possibility. Frequency characteristics can also be changed to meet varying operating conditions by altering the polarizing voltage.

The "Velotron" may be quickly connected to the amplifier by means of a simple adapter circuit consisting of two small resistors and condensers. A diagram illustrating the necessary circuit is furnished with each microphone.

The only VELOCITY mike with NO hum pick-up

### PHYSICAL CHARACTERISTICS:

The "Velotron" is sold complete with shock absorber, ball swivel, detachable cable connector, and 8 feet of single conductor shielded cable.

<i>Finish:</i> Gunmetal	<i>Dimensions:</i>
<input type="checkbox"/> Chrome \$1.00 extra	6 1/4" x 2 1/4" x 1 3/4"
	Net Weight: 1 Lb.

Velotron "MODEL A" (as described) List Price \$20.00

### GUARANTEE

The "Velotron" is unconditionally guaranteed by the Bruno Laboratories, Inc., against electrical and mechanical defects. If the guarantee card supplied with each microphone is properly filled out and mailed to us, we will replace without charge the sound cell of any "Velotron" within six months from date of purchase.

*This "no charge" replacement does not apply to the casing of the microphone*

Complete descriptive catalog sent on request

### CABLE CONNECTORS

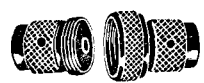

**C-1**  
To fill the need for a small positive and inexpensive cable connector, the Bruno Laboratories, Inc., announce a new cable connector, Model C-1. This is a small all-metal unit which permits instant connection or disconnection of two single conductor shielded cables.

**C-1.** This is a small all-metal unit which permits instant connection or disconnection of two single conductor shielded cables.

Its contact points are positive in action, self-wiping, and maintained under high pressures. Failure to hold contact is practically impossible.

### MONO-HAND STAND

A new, convenient, positive one hand stand. Positive internal expansion spring lock, adjustable with one hand!

An ingenious arrangement makes it possible to lower or raise, absolutely noiselessly, the movable part of the stand by the pressure of a button conveniently placed below the microphone. Finished in durable lacquered gunmetal, the beautiful modernistic lines blend pleasantly with modern studio furnishings.

Weight . . . . . 14 pounds.	Max. height . . . . . 59"
Min. height . . . . . 42"	List price . . . . . \$22.50

The unit cannot be damaged by being stepped upon. It cannot be accidentally disconnected. It is self-shielded and its diameter is only slightly greater than that of the cable, making its use inconspicuous.

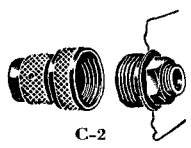

The Bruno cable connector is finished in gunmetal and accommodates cables 3/16" in diameter or less, and it is 3/4" in diameter and 1 1/2" long.

List Price \$1.25 (complete combination unit) Model C-1

List Price \$1.35 (complete combination unit) Model C-2

# BRUNO

LABORATORIES

20-22 West 22nd Street  
NEW YORK, N. Y.





# PAR-METAL



RACKS — PANELS — CABINETS

*— a size and style for every requirement*

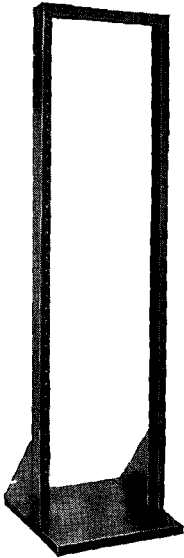

PAR-METAL offers you a uniform line of standardized metal products that enables you to quickly build up a job that is professional both in construction and appearance.

THE RACKS, cabinets, panels, etc., are the result of many years experience in making similar equipment for the sound industry. All of these products have been designed and made by a modern plant that has fabricated about everything from a small shield can to the metal work on a broadcast station.

*All of the parts shown are available in various standard sizes — a complete line that will meet almost every requirement*

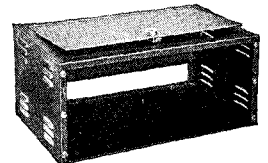
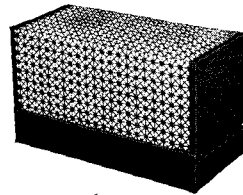
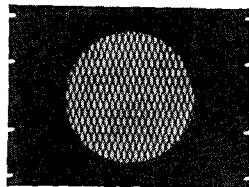
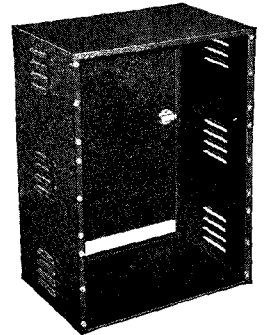
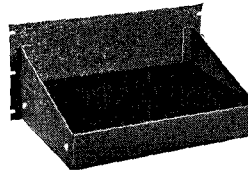
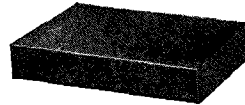
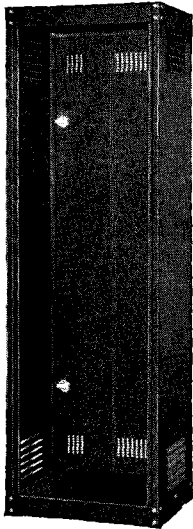
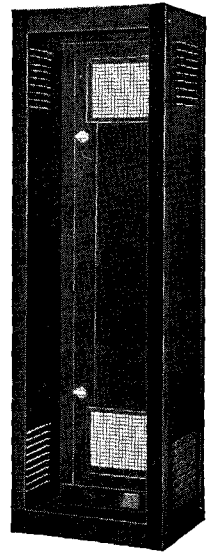

PAR-METAL PRODUCTS CORPORATION

3525 41st Street, Long Island City, N. Y.

# MACHINE vs. SHORT WAVE RECEIVER for RADIO CODE



## MACHINES FOR RENT OR SALE

The "Instructograph" Code Machine is manufactured in two sizes. The "Standard," as illustrated above, includes a full set of ten tapes and the Book of Instructions. This machine may be rented at a nominal monthly rate, and the rental paid may be applied on the purchase price, if it is desired to purchase after three months' trial, or sooner.

The "Junior" Model, similar in appearance to the standard machine, only smaller and with five tapes and the Book of Instructions, is not rented but may be purchased for \$12.00 — delivered to any point in the United States or Possessions. The small machine operates just as efficiently as the larger one — the difference being mainly in the size, weight and number of tapes supplied. Additional tapes, however, may be purchased at a reduced rate.

Send today for a detailed description of both machines, and the several renting propositions. A post card with your name and address is all that is necessary.

**WHY WASTE VALUABLE TIME** trying to become an Operator by listening to your Short Wave Receiver alone. Few indeed, ever get beyond the scant Amateur stage by that method.

The "Instructograph Way" permits you to practice uninterruptedly on whatever kind of sending you wish or need. You may practice any time — day or night; good or bad weather. Slow or fast as your advancement demands. You regulate the speed of sending as you wish.

No "fishing around" for some Amateur sending at your speed, and have him stop just about the time you get started to practice. No dividing your attention by "tuning" with one hand and trying to copy with the other. No weather or static interference with schedules.

So, if you are tired of trying to get a start, or are a "10 per" man, get the Instructograph and quickly get ALL the enjoyment of the AIR. To be limited to 13 or 20 words per minute on your Short Wave Receiver is about like it would be to have your Broadcast Receiver limited to "Bed-Time Stories." Get in the game right.

Read what a few of the boys say about the "Instructograph Way." We have hundreds of such letters from all sections of the Country.

CHAS. O. WEBER

321 W. GRAISBURY AVE., AUDUBON, N. J., SAYS:

"Boy, Oh Boy, Why I ever wasted about a year trying to learn to receive Code on my Short Wave Receiver, when I could buy an Instructograph, that would be willing to give me lessons whenever I was in the mood, for the small sum of \$20.25 — I do not know. You could not buy it back for many times the amount if you wished to do so.

"I have made wonderful progress in the past few weeks, and with the assistance of the Instructograph I am sure that I shall soon have all the speed I desire."

JOSEPH P. SKUTNIK

PINE ISLAND, NEW YORK, W2JWK, SAYS:

"In appreciation of the services the 'Instructograph' has rendered me, I wish to state that, in my opinion, there is no other machine on the market today that equals it when it comes to teaching the code.

"In my own case I could not pass the 8 word per minute mark after I had practiced four months by other methods. Today, after practicing with the Instructograph for a period of seven weeks, I can comfortably receive about 21 words per minute. On May 16th I took the Amateur examination and passed the code test with ease.

"You have my permission to reprint any of the above statements, to convince others that the Instructograph is just the machine to use in learning the code, or gaining speed."

ROTHWELL C. SMITH

348 N. MADISON ST., MARSHALL, MICH., SAYS:

"Everything coming along fine. With the aid of the Instructograph I can copy with the best of them around here. I can do thirty w.p.m. without any effort. Am going to try for my Second Class Operator's Ticket next week."

# INSTRUCTOGRAPH CO.

912 Lakeside Place

(Dept. HB-1)

Chicago, Illinois

# ACCEPTED AND APPROVED



**200-R**

200 Watts CW — 60 Watts Phone  
Amateur Net \$245

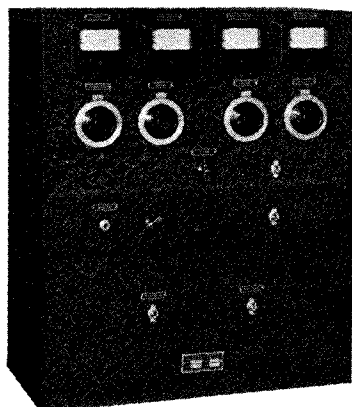

**80-T**

85 Watts CW — 20 Watts Phone  
Amateur Net \$135

*Above prices are less accessories  
and F.O.B. Brookline, Mass.*

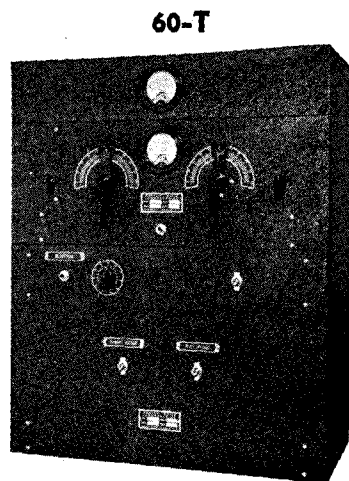

**60-T**

50 Watts CW — 15 Watts Phone  
Amateur Net \$88.20

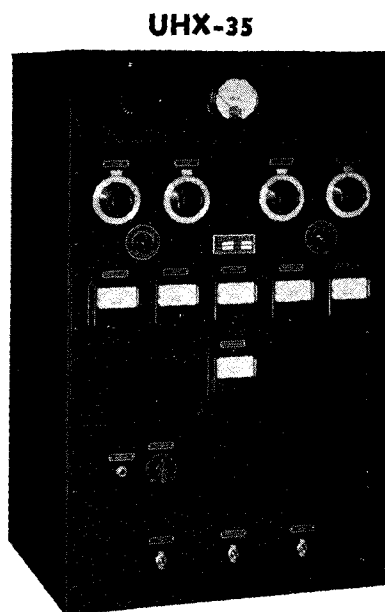

**UHX-35**

35 Watts Phone and CW  
Range: 2.5 to 20 Meters  
Amateur Net \$290

**B  
Y  
A  
M  
A  
T  
E  
U  
R  
S  
  
E  
V  
E  
R  
Y  
W  
H  
E  
R  
E**

ALSO — 60-X CW TRANSMITTER, 50-S PORTABLE, 700-A AMPLIFIER AND MI-4 MODULATION INDICATOR  
WRITE FOR FREE DETAILS AND PRICES

**HARVEY RADIO LABORATORIES, INC.**

12 Boylston Street, Brookline, Mass.

Export: 25 Warren Street, New York City

Cable: "Simontrice"

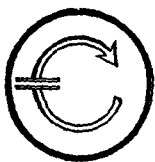

# CARDWELL CONDENSERS

FOR EVERY POWER AND PURPOSE

The Allen D. Cardwell Mfg. Corp., 83 Prospect St., Brooklyn, N. Y.

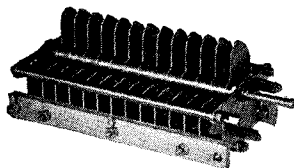
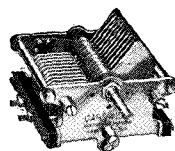

XC-100-XS

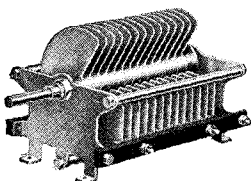

T-TYPE FRAME

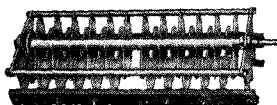

TZ-40-RD



VZ-5-RS

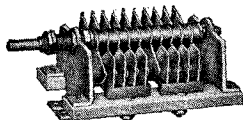

NP-35-GD

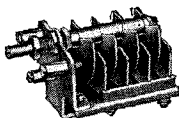

NA-14-NS

## STANDARD TRANSMITTING CONDENSERS

Type	Max. Cap.	Min. Cap.	Plate Edges	Number of Plates	Air Gap (In.)	Plate Thickness (In.)	Depth Behind Panel (In.)	Insulation	Amateur Net Price
XT-220-PS	220	20	Plain	21	.070	.025	4	Radion	\$2.35
XT-440-PS	440	40	"	43	.070	.025	5 1/2	"	4.12
XP-90-KS	90	16	Rounded	11	.084	.040	3	Mycalex	2.65
XP-165-KS	165	22	"	19	.084	.040	4	"	3.82
XP-290-KS	290	35	"	33	.084	.040	5 1/4	"	5.59
XP-330-KS	330	37	"	37	.084	.040	6 1/2	Radion	5.88
XE-240-KS	240	30	"	33	.100	.040	6 1/2	"	5.88
XG-25-KS	25	8	"	5	.171	.040	3	"	1.75
XG-50-KS	50	14 1/2	"	11	.171	.040	4	"	3.53
XG-110-KS	110	26	"	23	.171	.040	6 1/2	"	5.29
XK-55-KS	55	19	"	15	.230	.040	5 1/4	Mycalex	5.88
XC-18-XS	19	8.5	"	5	.200	.040	2 1/2	"	3.23
XC-40-XS	40	14 1/2	"	11	.200	.040	4	"	4.41
XC-65-XS	65	20	"	17	.200	.040	5 1/4	"	5.59
XC-100-XS	100	28	"	25	.200	.040	7 3/8	"	6.76
TJ-150-US	150	28	"	15	.168	.050	5 1/2	"	13.52
TJ-315-US	315	31	"	31	.168	.050	9 3/4	"	18.82
TC-150-US	160	38	"	19	.200	.050	7 1/4	"	14.11
TC-200-US	200	40	"	23	.200	.050	8 1/4	"	16.46
TC-300-US	300	42	"	35	.200	.050	11 1/4	"	18.82
TL-50-US	50	18	"	7	.294	.050	4 1/2	"	9.70
TL-100-US	100	26	"	15	.294	.050	7 1/2	"	12.94
TL-160-US	160	40	"	25	.294	.050	11	"	17.64
TL-200-US	200	46	"	31	.294	.050	13 1/8	"	19.40
TZ-40-RS	40	15	"	11	.500	.050	8 3/8	"	16.46
TZ-80-RS	80	26	"	21	.500	.050	13 3/8	"	23.23

## STANDARD DOUBLE TRANSMITTING CONDENSERS

Type	Max. Cap.	Min. Cap.	Plate Edges	Number of Plates	Air Gap (In.)	Plate Thickness (In.)	Depth Behind Panel (In.)	Insulation	Amateur Net Price
XR-500-PD	500	18	Plain	21	.030	.025	4	Radion	\$3.53
XT-80-PD	80	11	"	9	.070	.025	4	"	2.94
XT-210-PD	210	22	"	21	.070	.025	5 1/4	"	4.70
XP-90-KD	95	15	Rounded	11	.084	.040	4 1/2	Mycalex	4.41
XP-165-KD	165	23	"	19	.084	.040	6 1/2	"	6.47
XP-325-KD	325	38	"	37	.084	.040	11 1/4	"	12.94
XE-240-KD	240	32	"	33	.100	.040	11 1/4	"	12.35
XG-50-KD	50	14	"	11	.171	.040	6 1/2	"	5.88
XG-110-KD	110	27	"	23	.171	.040	11 1/4	"	10.58
TJ-200-UD	200	30	"	21	.168	.050	12	"	21.17
XC-40-XD	40	14	"	11	.200	.040	7 3/8	"	7.64
XC-75-XD	75	21 1/2	"	19	.200	.040	11 1/4	"	10.03
TC-160-UD	160	38	"	19	.200	.050	12 1/4	"	20.03
TC-200-UD	200	40	"	23	.200	.050	14 1/4	"	22.34
TC-250-UD	250	40	"	29	.200	.050	17 1/4	"	24.70
TL-50-UD	45	13	"	7	.294	.050	7 3/8	"	14.70
TL-100-UD	94	26	"	15	.294	.050	13 3/8	"	20.29
TL-160-UD	160	36	"	25	.294	.050	20 1/4	"	25.87
TZ-40-RD	40	15	"	11	.500	.050	14 3/8	"	25.28

Max. and Min. Cap. and Number of Plates are Per Section on Double Condensers

## NEW ULTRA HIGH FREQUENCY DOUBLE TRANSMITTING CONDENSERS

NP-35-GD	35	5	Rounded	9	.084	.040	4 1/8	Isolantite	\$3.53
JD-28-GD*	28	5	"	11	.125	.040	6 1/8	Iso. & Myc.	9.55
JP-48-GD*	48	6	"	13	.084	.040	6 1/8	"	9.55

(\* Balanced type, Isolantite End Plates, 4 Mycalex Tie Bars—No metal frame. Designed for high frequency therapy machines.

## HIGH FREQUENCY NEUTRALIZING CONDENSERS

VZ-5-RS*	5	2	Rounded	2	.500	.050	4	Mycalex	\$9.70
NA-4-NS	4	2.5	"	2	Adj.	.040	1 7/8	"	2.12
NA-5-NS	5	2.8	"	3	.218	.040	1 7/8	"	2.12
NA-14-NS	14	5	"	8	.218	.040	3 3/8	"	2.94

(\* Air Gap and Capacity adjustable, by movement of threaded rotor bushing.

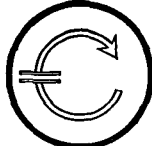

# CARDWELL CONDENSERS

FOR EVERY POWER AND PURPOSE

The Allen D. Cardwell Mfg. Corp., 83 Prospect St., Brooklyn, N. Y.

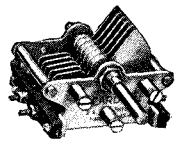

## TRIM-AIR MIDGET CONDENSERS

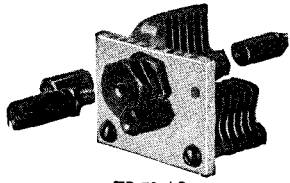

ZR-50-AS

Type	Max. Cap.	Min. Cap.	Plate Edges	Number of Plates	Air Gap (In.)	Plate Thickness (In.)	Depth Behind Panel (In.)	Insulation	Amateur Net Price
ZR- 10-AS	10	1.2	Plain	3	.031	.020	3/4	Isolantite	\$. 73
ZR- 15-AS	15	1.5	"	5	.031	.020	1 1/8	"	. 73
ZR- 25-AS	25	2.0	"	7	.031	.020	1 3/8	"	.82
ZR- 35-AS	35	2.5	"	11	.031	.020	1 7/8	"	.88
ZR- 50-AS	50	2.8	"	13	.031	.020	1 5/8	"	.94
ZU- 75-AS	75	2.7	"	15	.020	.020	1 7/8	"	1.00
ZU-100-AS	100	3.0	"	19	.020	.020	1 3/4	"	1.03
ZU-140-AS*	140	5.0	"	27	.020	.020	1 7/8	"	1.85
ZT- 30-AS	30	4.0	"	17	.070	.020	2 1/8	"	1.09
ZS- 4-SS	4	1.5	Rounded	5	.150	.040	1 1/4	"	1.09
ZV- 5-TS†	5	1.8	Plain	3	.061	.040	1 1/8	"	. 73

(†) Supplied with 2 segment stator, for 5 meter circuits. Extra plate also supplied, easily installed, makes it 3 plate as listed.

(\* ) Double bearing—two end plates.

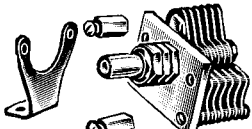

TRIM-AIR AND ACCESSORIES

## ACCESSORIES FOR TRIM-AIR MIDGET CONDENSERS

MOUNTING BRACKET, with two screws and nuts.....	\$. 06
EXTRA EXTENSION SHAFT (Used for ganging)—Plus setting nut.....	. 04
MOUNTING POSTS (one pair req'd per condenser, with screws and lockwashers.....	. 05

## MIDWAY RECEIVING CONDENSERS

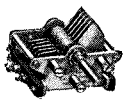

MR-50-BS

Type	Max. Cap.	Min. Cap.	Plate Edges	Number of Plates	Air Gap (In.)	Plate Thickness (In.)	Depth Behind Panel (In.)	Insulation	Amateur Net Price
MR- 25-BS	25	5.0	Plain	3	.031	.025	2 3/8	Radion	\$1.35
MR- 50-BS	50	6.0	"	5	.031	.025	2 3/8	"	1.41
MR- 70-BS	70	7.0	"	7	.031	.025	2 7/8	"	1.50
MR-105-BS	105	8.0	"	11	.031	.025	2 3/4	"	1.56
MR-150-BS	150	9.5	"	15	.031	.025	2 3/8	"	1.62
MR-260-BS	260	11.0	"	25	.031	.025	3 1/8	"	1.65
MR-365-BS	365	13.5	"	35	.031	.025	3 1/8	"	1.94

## MIDWAY TRANSMITTING CONDENSERS

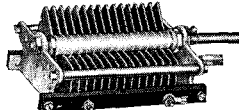

MT-150-GS

Type	Max. Cap.	Min. Cap.	Plate Edges	Number of Plates	Air Gap (In.)	Plate Thickness (In.)	Depth Behind Panel (In.)	Insulation	Amateur Net Price
MT- 20-GS	20	5.0	Rounded	5	.070	.025	2 3/8	Radion	\$1.68
MT- 35-GS	35	6.0	"	7	.070	.025	2 3/8	"	1.82
MT- 50-GS	50	8.0	"	11	.070	.025	2 3/8	"	2.06
MT- 70-GS	70	10.0	"	15	.070	.025	3 3/8	"	2.32
MT-100-GS	100	12.0	"	21	.070	.025	3 3/8	"	2.59
MT-150-GS	150	16.0	"	31	.070	.025	4 1/2	"	3.23
MG-35-GS	35	12.0	"	15	.171	.040	4 1/2	Mycalex	3.53

## MIDWAY DOUBLE CONDENSERS

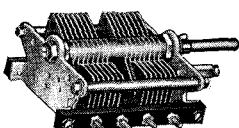

MR-150-BD

Type	Max. Cap. Per Sec.	Min. Cap. Per Sec.	Plate Edges	Number of Plates Per Sec.	Air Gap (In.)	Plate Thickness (In.)	Depth Behind Panel (In.)	Insulation	Amateur Net Price
MR- 25-BD	25	4.5	Plain	3	.031	.025	2 3/8	Radion	\$2.32
MR- 50-BD	50	5.5	"	5	.031	.025	3 1/8	"	2.47
MR- 70-BD	70	6.5	"	7	.031	.025	3 3/8	"	2.59
MR-100-BD	100	7.5	"	11	.031	.025	3 3/8	"	2.70
MR-150-BD	150	8.5	"	15	.031	.025	3 3/8	"	2.82
MR-260-BD	260	11.0	"	25	.031	.025	4 1/2	"	2.94
MO-180-BD	180	15.0	"	29	.050	.025	6 1/4	"	4.70
MT- 20-GD	23	5.5	Rounded	5	.070	.025	3 3/8	"	2.97
MT- 35-GD	35	7.0	"	7	.070	.025	3 3/8	"	3.23
MT- 50-GD	50	9.0	"	11	.070	.025	3 3/8	"	3.44
MT- 70-GD	70	10.0	"	15	.070	.025	4 1/2	"	3.82
MT-100-GD	100	13.0	"	21	.070	.025	6 1/4	Mycalex	4.70

# T. R. McELROY

World's Champion Radio Telegrapher



Official Record  
69 wpm Brockton 1935

23 BAYSIDE STREET  
UPHAMS CORNER P. O.  
BOSTON, MASS.



51 WPM BOSTON 1920  
56½ WPM CHICAGO 1922  
55 WPM NEW YORK 1921

*You can send better with a MAC KEY or your money refunded after five day trial*

1. Massively constructed base and superstructure one solid casting. Vibrationless.
2. Name plate with serial number for operator's protection.
3. Binding post. Other post is number 19.
4. Vibration dampener on swivel so may be thrown out of way for handling weights.
5. Vibration dampener adjustment screw so that roll hits rod exact center.
6. Vibration dampener roll in machined slot for beautifully stutterproof sending.
7. Straight key changeover lever, locks rod for shipping and handling also.

**\$7.95**

f.o.b. Boston

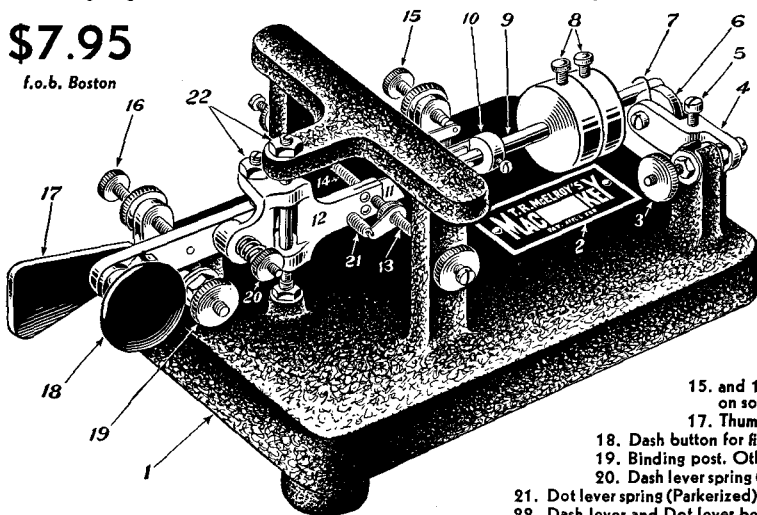

8. Speed governor weights. 5 wpm to 50 wpm.
9. Vibrating rod.
10. Dot U spring holding and adjusting collar. This U spring formed in a die out of highest quality Swedish blued steel of exact weight desired and then Parkerized for longevity.
11. Main spring also selected after exhaustive experimenting for correct weight and also Parkerized.
12. Main lever yoke casting which provides the excellent dash lever suspension.
13. Dot lever back stop screw.
14. Dot lever travel screw.
15. and 16. Dot and Dash contact screws on solid bar for perfect alignment.
17. Thumb paddle for dots.
18. Dash button for first and second fingers.
19. Binding post. Other post is number 3.
20. Dash lever spring (Parkerized) and adjustment nut.
21. Dot lever spring (Parkerized) and adjustment nut assembly.
22. Dash lever and Dot lever bearing adjustment screws.

## FOR TELEGRAPH OPERATORS \$10.00

I have a special model with circuit closer and my Mac Cord affixed to binding posts, which I've made up because so many telegraph operators wanted my key but needed these extras for use on telegraph wires.

## MAC OSCILLATOR @ \$3.95

(either AC or DC)

Tone control, 1000, 800, and 600 cycle note. Phone output 2000 ohms and 10 DB. Separate output 200 ohms — 30 DB. This oscillator is really a great asset in improving code. Uses 2 No. 76 tubes.

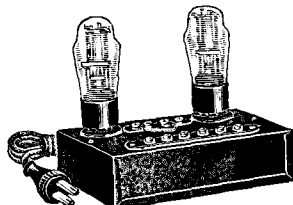

*All Mac Items Stocked and Sold by Nearly All Distributors*

# AN OPEN LETTER TO THE OPERATORS

Writing an ad is an art itself and I haven't got it. As I've said many times I try to give every pennies worth of value possible in my items and it doesn't leave the extra dough to hire hifalutin' ad writers. So just read this as a kinda personal note from me to you fellers: —

I show a cut of my MAC KEY on the other page. Actually the ones I now ship are quite a lot better because when I had to make up special dies and jigs etc., to make extra special speed keys on an order from a certain government department (which, by the way, never purchased speed keys prior to my Mac Keys) — as I was saying, with these special tools, I was able to make an awful lot of improvements on the regular key.

## DELUXE MODEL MAC KEY @ \$15.00

No cut made, but just try to picture in your mind's eye the most beautiful instrument you ever thought of — that's my deluxe model. Huge  $\frac{1}{4}$  x 32 bronze screws, 3/16" contacts, completely and beautifully chromium plated — that's it. It's a honey.

## MAC AUTO @ \$69.00

I think (and I hope!) that most operators throughout the world know by this time that I try to be truthful in describing my items. I therefore ask that you please believe me when I say that my MAC AUTO is so incomparably superior to any automatic ever heretofore built that it is about impossible to over-emphasize its excellence.

Uses either AC or DC 110V. Complete with all tubes.

Completely electrical. Not a single mechanical part except motor and even motor speed governed electrically.

Oscillator is built into it operating directly from photo-electric cell. No relays!

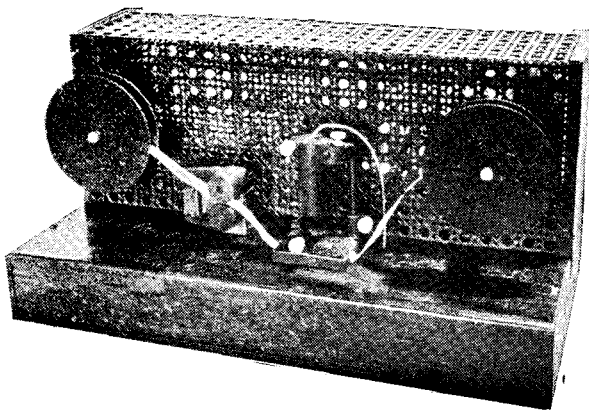

The first and the only automatic code machine using photo-electric cell.

The jobbers, who are your friends as well as mine, will sell this auto on time payments.

Entirely new in principle: it is completely electrical with no moving or mechanical parts excepting the motor and even the varying of motor speed is electrical, being accomplished by varying shunt windings juice. So far as I can determine from tests of my first working model, the speed is limitless!

MAC AUTO uses ordinary commercial recorder tape which means that the supply of tape is endless and the cost is but slightly more than the actual cost of the paper. *MOREOVER AND OF UTMOST IMPORTANCE* any code may be used — regular radio code (Continental Morse), telegraph code (American Morse) and other codes to which I do not care to refer in this ad, but will give information when it is sought.

The Mac Auto will probably be handled by Candler in connection with his courses, but it will also be sold by the radio distributors who've been such good friends of mine from the start and without whose support I just could not have lasted as long as I have. To them, now and publicly, my sincere thanks for their support. To the thousands of hams who've bought my stuff, written encouraging letters and boosted the key, my sincere thanks. Best wishes and good bye until we meet on these pages next year.

Mac.

*All Mac Items Stocked and Sold by Nearly All Distributors*

# COMPLETE LIST OF EVEREADY Trade Mark RADIO BATTERIES

Catalog Number	Voltage and Type	Type of Terminals	Terminal Markings	Dimensions Inches			
				L	W	H	over all
<b>RADIO "B" BATTERIES</b>							
485	45-Volt, Medium Size, Layerbilt	PLUG-IN	-, +22 ½, +45	8 1/32	3 1/16	7 3/16	8
486	45-Volt, Large Size, Layerbilt	PLUG-IN	-, +22 ½, +45	8	4 1/32	7 3/16	8
772	45-Volt, Medium Size, Round Cell	PLUG-IN	-, +22 ½, +45	7 5/16	3 1/32	7 3/16	8
770	45-Volt, Large Size, Round Cell	PLUG-IN	-, +22 ½, +45	7 3/32	4 5/16	7 3/16	8
766	22 ½-Volt, Medium Size, Horizontal	Fahnestock	-, +18, +22 ½ +, -3, -4 ½	6 11/16	4 1/16	3 5/32	3 3/4
779	22 ½-Volt, Medium Size, Vertical	Fahnestock	-, +22 ½	4 3/16	3 1/16	7 3/32	7 11/16
769	Aircraft Beacon Receiver Battery	Insulated Screw	-9, -4 ½ -3 -1 ½, 0, +22 ½ +45, +67 ½, +135	9 7/8	2 13/16	7 3/32	7 9/16
794	45-Volt Police Squad Car Battery	Fahnestock	-, +22 ½, +45	8 1/16	4 1/2	7 3/16	8
796	45-Volt Auto Radio Battery	Fahnestock	-, +22 ½, +45	7 13/16	3 1/32	7 3/16	8
<b>RADIO "AIR CELL" "A" BATTERIES</b>							
A-600	Air Cell "A" Battery	Insulated Screw	-, +	9 7/8	6 9/16	-	10 13/16
SA-850	Air Cell "A" Battery	Insulated Screw	-, +	13 1/2	6 3/4	-	11
X-124	3-Volt Dry "A" Battery	Insulated Screw	-, +	10 1/4	10 1/4	6 3/4	--
X-125	3-Volt Dry "A" Battery	Insulated Screw	-, +	11 5/16	4 1/4	6 1/8	6 1/2
7111	1 ½-Volt Dry "A" Battery	Screw		2 5/8	Diam.	-	6 5/8
<b>GENERAL PURPOSE BATTERIES</b>							
761	4 ½-Volt General Purpose	Fahnestock	-, +	4	1 3/8	3 1/32	3 11/16
761-T	4 ½-Volt General Purpose	Screw	+, -1 ½, -3 -4 ½	4	1 3/8	3 1/32	3 17/32



Catalog Number	Voltage and Type	Type of Terminals	Terminal Markings	Dimensions Inches			
				L	W	H	over all
<b>RADIO "C" BATTERIES</b>							
768	22 ½-Volt "C" Battery	PLUG-IN	+, -3, -4 ½ -16 ½, -22 ½	4 ¾	2 ½	2 ⅞	3 ⅜
771	4 ½-Volt "C" Battery	PLUG-IN	+, -3, -4 ½	4	1 ⅜	3 ½	3 11/16
778	22 ½-Volt "B" or "C" Battery	Fahnestock	+, -3, -4 ½ -6, -9, -10 ½ -16 ½, -22 ½	4 ¾	2 ½	2 ¾	3 ⅜
781	4 ½-Volt "C" Battery	Screw	+, -4 ½	2 ⅞	¾	2 11/16	3 ⅞
773	7 ½-Volt "C" Battery	Screw & Wire	+, -1 ½, -3 -4 ½, -6, -7 ½	4 1/16	2 ⅞	2 27/32	3 ¼
783	15-Volt "C" Battery	Fahnestock	+, -3, -4 ½ -10 ½, -13 ½ -15	4 ¼	1 ¾	2 27/32	3 7/16
798	22 ½-Volt Auto Radio "C" Battery	Fahnestock	+, -3, -4 ½ -16 ½, -22 ½	4 ¾	2 ½	2 ¾	3 ⅜
<b>PORTABLE BATTERIES</b>							
762	45-Volt, Portable	Insulated Screw	-, +22 ½, +45	4 7/32	2 9/16	5 27/32	6 5/16
763	22 ½-Volt, Portable	Screw	-, +22 ½	3 13/32	2 1/16	2 17/32	2 7/8
764	22 ½-Volt, Portable, Vertical	Fahnestock	-, +22 ½	3 5/32	2 21/32	5 17/32	6 3/16
X-187	7 ½-Volt Dry "A" Battery	Screw	-, +	2 25/32	2 3/16	3 7/8	4 3/8
X-188	135-Volt, Portable	Insulated Screw	-, +	8 9/16	1 ¼	3 7/8	4 3/8
X-200	3-Volt Dry "A" Battery	Screw	-, +	3 3/8	1 13/32	5 13/32	5 3/4
X-201	45-Volt, Portable	Screw	-, +	3 1/32	2 5/16	3 3/4	4 1/16
X-202	3-Volt Dry "A" Battery	Screw	-, +	2 21/32	1 11/32	2 3/16	2 13/16
X-203	45-Volt, Portable	Screw	-, +	3 1/32	1 5/16	3 3/4	4 1/16
X-204	7 ½-Volt "C" Battery	Screw	+, -4 ½, -7 ½	2 7/8	5/8	1 3/8	1 13/16

**BATTERY HEADQUARTERS**  
**NATIONAL CARBON COMPANY, Inc.**

*General Offices: New York, N. Y.*

*Branches: Atlanta, Boston, Chicago, Cleveland, Dallas, Kansas City, Louisville,  
 Minneapolis, New York, Philadelphia, Pittsburgh, Portland, San Francisco*

*Unit of Union Carbide  and Carbon Corporation*

# JNCO MEANS DEPENDABILITY

## DUNCO RADIO RELAY

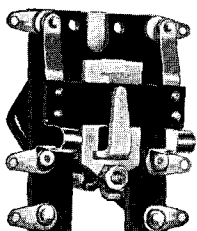

These relays have two isolated contacts for operation in low or high voltage circuits at any frequency. For the first time in an inexpensive relay, the two poles are sufficiently spaced and shielded from each other so that the amplifier input may be handled by one pole and the output from the same amplifier may be handled by the other pole without feed back. Similarly 60-cycle power currents may be handled by one pole and voice frequencies by the other without the introduction of hum. Outstanding features include: low contact resistance; single break contacts instead of double break to further reduce resistance; extremely fast operation suitable for bug eyeing; high voltage and current carrying and breaking capacity; resistance to vibration, making the relay suitable for use on autos, trains, planes, elevators, boats, etc.

Type	Operates on
1A-1	2.5 volts, 60 cycles, a.c.
1A-2	2.5 volts, 25 cycles, a.c.
1A-3	6.3 volts, 60 cycles, a.c.
1D-1	5 to 6.3 volts, d.c.

Any One Type  
Your Cost, \$2.00

## DUNCO VACUUM TUBE RELAY

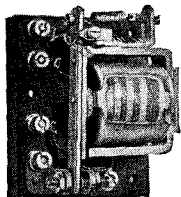

Relay type CXB51 is an ultra sensitive unit designed for direct current in the coil circuit and either direct or alternating current in the contact circuit. It has single pole, double throw contacts, making one circuit when the coil is energized and another circuit when the coil is de-energized. The coil has a resistance of 10,000 ohms and it will safely carry currents up to 18 milliamperes. Adjustments are provided that will cause the relay to operate on any desired current value down to one milliampere. This unit is particularly adapted to operation in the plate circuit of small vacuum tubes. Contacts are rated 2 amperes at 110 volts, a.c.

Size: 2 7/8" high x 2 1/4" wide x 2" deep

Dunco Relay, Type CXB51  
Your Cost, \$5.50



# DUNCO RELAYS

## FOR AMATEUR USE

**STRUTHERS DUNN, Inc.**  
126 N. JUNIPER ST., PHILADELPHIA, PA.

## DUNCO TEMPERATURE CONTROL RELAY

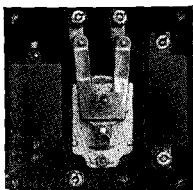

Dunco relay type CS-1022 has been developed for use in conjunction with mercury thermoregulators for accurate temperature control work. For operation on 110 volts, 60 cycles, it will properly control heater units up to 3,300 watts. The resonant circuit employed makes the relay extremely sensitive and resistors are used to limit the current in the thermoregulator to a safe value of about 12 milliamperes and to reduce arcing at the thermoregulator contacts. Relay is designed for vertical mounting.

Size: 5" high x 5" wide x 3" deep

Dunco Relay, Type CS-1022  
Your Cost, \$11.00

## DUNCO TIME DELAY RELAY

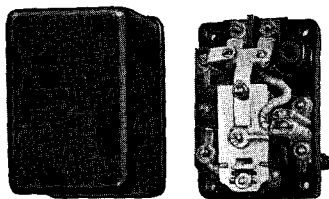

This time delay relay is provided with a snap-on housing and with panel mounting studs for back of panel connections. The input terminals should be connected across the primary of the filament transformer, and the output terminals to the primary of the plate transformer. Power will then be delivered to the plate transformer 30 seconds after the filaments are turned on, greatly increasing the life of tubes, particularly of the hot cathode mercury vapor type. This unit is suitable for use with plate transformers up to 500 watts capacity if the rectifier feeds directly into a condenser or up to 1,000 watts if a choke precedes the first condenser in the filter system.

Size: 3" high x 2 1/8" wide x 2 5/16" deep including cover

Dunco Relay, Type TD-96  
Your Cost, \$8.80

## DUNCO MIDGET KEYING RELAY

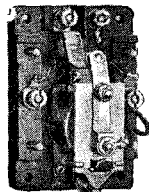

This midget keying relay is suitable for speeds up to 40 words per minute. Contacts are large fine silver buttons assuring long life and may be easily replaced. Coil consumes only 50 milliamperes at 110 volts, 60 cycles, while contacts will interrupt currents of 6 amperes at 110 volts, a.c. The unit is designed for mounting on vertical panel and is recommended for loads up to 660 watts. The contacts are single pole, and close when the coil is energized.

Size: 2 3/4" high x 1 7/8" wide x 1 3/4" deep

Dunco Relay, Type ASBX1

Your Cost, \$3.85

Other Dunco Midget Relays (See Note)

Type	Contact Arrangement	Your Cost
ABTX1	S.P.D.B. Front Contact	\$3.85
ABTX1P	S.P.D.B. Fr. Cont. with Pigtail	4.40
ADBX1	D.P.S.B. Front Contact	4.95
B5BX1	S.P.S.B Back Contact	3.85
CSBX1	S.P.S.B. Double Throw	4.68
CDBX1	D.P.S.B. Double Throw	6.60

Note: These relays do not operate as rapidly as Type ASBX1.

## DUNCO REMOTE CONTROL RELAY

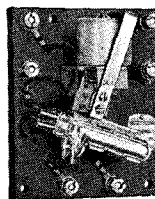

This power type relay handles loads up to 20 amperes at 220 volts, or 25 amperes at 110 volts. It is of particular service in remotely controlled transmitters, receivers, motors, or other loads of any nature within its rating. Provisions are made so that the mercury contact will make when the coil is energized and break when the coil is de-energized or vice versa. An outstanding feature is that it is completely silent in operation — no humming or chatter occurs when the coil is energized. Another outstanding feature is that due to mercury contacts there is no sticking or burning of contacts. Sturdy Pyrex enclosed contactors are employed. Standard coils are for operation on 110 volts, 60 cycles, but other coils are available. This unit is designed for vertical panel mounting.

Size: 5" high x 4" wide x 2 5/8" deep

Dunco Relay, Type CXH-1027  
Your Cost, \$11.00

**WE BUILD TO MEET SPECIAL REQUIREMENTS**

# The *Standard* Coil Forms

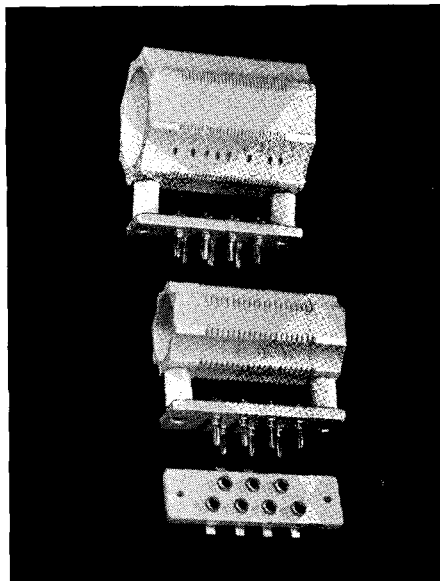

**E**NTHUSIASTICALLY indorsed by thousands of users, these coil forms are standard in low- and medium-power amateur oscillator and amplifier circuits.

Designed to afford the maximum of convenience at a really low price . . . notched moulded porcelain forms, hermetically treated . . . convenient "starting and stopping places" to facilitate short leads between the form and the plug base . . . equipped with 7 G-R low-resistance plugs . . . these forms fill the bill in any amateur station.

Two sizes are available:

Type 677-Y Form alone (160 and 80 m) . . . . .	\$0.75
Type 677-U Form alone (80, 40 and 20 m) . . . . .	\$0.50
Type 677-P1 Spacers, per pair . . . . .	\$0.30
Type 678-P Plug Base (with 7 plugs) . . . . .	\$0.70
Type 678-J Jack Base (with 7 jacks) . . . . .	\$0.65

*For catalog of many other experimental and amateur parts and accessories write for Bulletin 52-Q*

## GENERAL RADIO COMPANY

Cambridge



Massachusetts

# Meissner

## FERROCART (Iron Core) Variable Selectivity I.F. Transformers

The Meissner Band Expanding Ferrocart (Iron-Core) I.F. Transformer has been designed to meet the need for a unit to provide facilities for obtaining the razor-sharp selectivity required for efficient foreign or CW reception and to provide the broad band width necessary for high-fidelity reception of local stations. It is electrically variable and no shafts or cam controls are required. Merely a two or three-position switch. Frequency 456 (440-470) KC.

SIZE: 1 7/8" x 1 1/2" x 3/4"

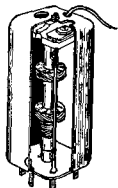

Meissner No.	Type Tuning	No. Pos.	List Price
7410	Mica	2	\$3.00
7412	Mica	3	3.00
7414	Align-Aire	2	5.50
7416	Align-Aire	3	5.50

## FERROCART (Iron Core) Adjustable Inductance Antenna Coil



Meissner again leads the field with this universal adjustable inductance FERROCART (iron-core) antenna coil. With this coil, tracking the condenser when replacing an antenna coil becomes extremely simple. 1 3/4" x 1 3/4" x 2 3/4".

Meissner No. 7413. . . . . List Price \$2.00

## Standard Iron Core R.F. and Antenna Coils

Meissner No.	Type	List Price
1496	Antenna — High Imp.	\$1.50
7411	Antenna — Low Imp.	1.50
1497	R.F. Coil — High Imp.	1.50

Similar to above unit; size 1 3/4" x 1 3/4" x 2 3/4".

## FERROCART (Iron Core) Shielded Wave Traps (440-470 Kc.)

Designed to eliminate interference by tuning the coil to provide resonance to the undesired frequency. Ferrocart (Iron-Core) permeability tuned providing increased gain and selectivity over a wider inductance range.

SIZE: 1 7/8" DIA. x 2 1/4"

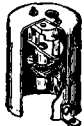

Size 1 3/4" x 1 3/4" x 2 3/4".  
Model No. 7523. . . . . List \$2.00

## NEW! Air Tuned "Align-Aire" Condensers

The requirements imposed upon aligning condensers used in connection with modern receivers are, LOW LOSS, STABILITY, under extreme climatic conditions and mechanical abuse, EASE OF ADJUSTMENT and ABSENCE OF MICROPHONIC NOISES and above all, ELIMINATION of "DRIFTING."

To those who have felt that such a unit has hitherto been unavailable, MEISSNER offers the Align-Aire Condenser. They are suitable for numerous applications and can be mounted in various positions.

These trimmers are an air-dielectric type condenser. Mounted in a low loss container. Firm electrical connection. Automatic frictions, locking at any capacity setting, permanent in adjustment. Micro-adjustment. Ten turns are required to cover the complete range of the trimmer.

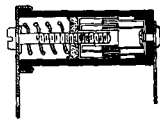
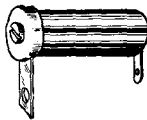

Cat. No.	Capacity	Size	List Price
15230	1- 12 mmf.	9/16" x 1 1/4"	\$0.50 ea.
15232	3- 25 mmf.	9/16" x 1 1/2"	.60 ea.
15240	25- 50 mmf.	7/8" x 1 1/2"	.75 ea.
15200	55-110 mmf.	7/8" x 1 3/2"	1.25 ea.

### Advantage Over the Compression Type

A motion of a few thousandths of an inch produces a barely perceptible change in capacity. Contrast this with the conventional compression type of mica dielectric in which the same movement can change the capacity as much as 100%. These condensers show no measurable drift when subjected to temperature of 150°F., 100 hours intense vibration or 100 hours exposure to 95% relative humidity at 76°F.

## "Align-Aire" Air Tuned Transformers

Align-Aire tuning means 3600 degrees of hair line smooth micrometer adjustment; never changing self locking setting eliminating shifting; moisture proof; dust proof; temperature proof. Complete elimination of "drifting."

Align-Aire I.F. transformers are double tuned; with top tuning for ease in aligning circuits and uses the new Meissner Perma Strut construction, permanently placing every lead so that they will not "shift." Furnished in either air-core or iron-core (Ferrocart).

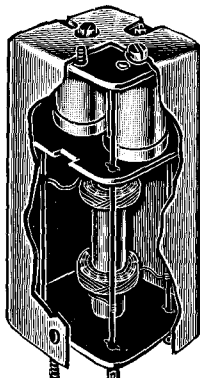

Size 2" x 2" x 4 1/2"

Iron Core			Air Core		
Cat. No.	List Price	Freq. Range and Application	Cat. No.	List Price	
6631	\$4.50	170-180 Input	6630	\$3.75	
5977	4.50	170-180 In-stage	5979	3.75	
6633	3.40	170-180 Output	6632	3.75	
.....	.....	170-180 Beat freq. osc.	6671	3.25	
.....	.....	170-180 Silencer	6857	4.00	
6635	4.50	250-265 Input	6634	3.75	
5967	4.50	250-265 In-stage	5971	3.75	
6637	4.50	250-265 Output	6636	3.75	
.....	.....	250-265 Beat freq. osc.	6773	3.25	
.....	.....	250-265 Silencer	6859	4.00	
6639	4.50	360-380 Input	6638	3.75	
5993	4.50	360-380 In-stage	6011	3.75	
6641	4.50	360-380 Output	6640	3.75	
.....	.....	360-380 Beat freq. osc.	6777	3.25	
.....	.....	360-380 Silencer	6867	4.00	
6643	4.50	440-470 Input	6642	3.75	
6123	4.50	440-470 In-stage	6129	3.75	
6645	4.50	440-470 Output	6644	3.75	
6139	4.50	440-470 Output CT	6163	3.75	
.....	.....	440-470 Beat freq. osc.	6779	3.25	
.....	.....	440-470 Silencer	6869	4.00	
6239	4.50	2900-3100 Input	6243	3.75	
6239	4.50	2900-3100 In-stage	6243	3.75	
6241	4.50	2900-3100 Output	6247	3.75	
.....	.....	2900-3100 Beat freq. osc.	6793	3.25	
.....	.....	2900-3100 Silencer	6881	4.00	

**FREE** Our complete catalog is ready. Everything in coils; I.F., R.F., Chokes, etc. as well as complete all wave and special short-wave tuning assemblies and complete coil kits for sets from two to fourteen tubes. You need this guide to help you select the proper coil or coil assembly.

**MEISSNER PRODUCTS ARE SOLD BY ALL LEADING JOBBERS**

**MEISSNER MFG. CO., MT. CARMEL, ILLINOIS**



## Multi-Wave Assembly

(Mono-unit construction)

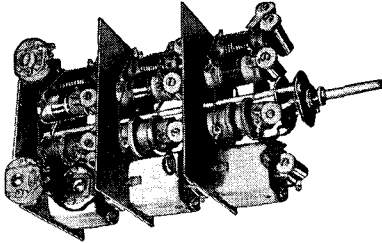

In answer to the constant demand for an "All Wave" coil assembly that will meet the demands of modern requirements, Meissner offers the coil and switch assembly as shown in the illustration.

The unit embodies all coils, range switch, shunt trimmers, series padders, A.V.C., by-pass condensers and necessary shielding. It is in fact the entire "Front End" of an all-wave set, exclusive of the gang condenser and tubes. Aligned and padded. No adjustments necessary. **ALIGN-AIRE** (air dielectric) **Trimming Condensers used on all bands**, except the ultra high frequency band, which requires no trimmers. The essential features of this assembly are listed below in condensed form.

essentially no leads from coils to switch (all coils except long wave, 2000 meters, supported by their lugs from switch. **4.** No common grounds. Tuned circuit ground returns, connect directly to respective gang wipers. **5.** All leads short and direct resulting in uniformity of all assemblies. **6.** **ALIGN-AIRE** (air dielectric) trimming condensers used on all bands, except the ultra high frequency band which requires no trimmers. **7.** Padding condensers — Variable mica on the long wave and broadcast and police bands, fixed mica on the 6 to 18 MC band and no pad on the ultra high frequency band. **8.** R.F. stage is used on all bands except the ultra high frequency band. **9.** The oscillator-detector unit has circuit constants giving uniform oscillation voltage and optimum conversation conductance on all bands. **10.** Simple compact chassis lay-out.

**1.** Aligned and padded. Completely assembled and accurately balanced. Ready to work. No adjustments necessary. No testing equip. necessary. **2.** Simple, efficient coil construction — individual coils for each band. **3.** Es-

### AVAILABLE IN FIVE DIFFERENT COMBINATIONS

For Use with 410 mmf. Condenser		
5 Band	4 Band	3 Band
7.5 to 20	7.5 to 20	16.4 to 51
16.4 to 51	16.4 to 51	48.5 to 177
48.5 to 177	48.5 to 177	167 to 555
167 to 555	167 to 555	
732 to 2140		
Model No. 7505 — List \$21.00	Model No. 7504 — List \$17.50	Model No. 7503 — List \$16.00

For Use with 260 mmf. Condenser	
5 Band	4 Band
3.8 to 9.9	3.8 to 9.9
9.7 to 25	9.7 to 25
24 to 68	24 to 68
67 to 200	67 to 200
190 to 555	
Model No. 7515 — List \$21.00	Model No. 7514 — List \$17.50

## 14-Tube "Communications" Receiver Kit

Utilizing the MEISSNER  
Completely Assembled Tuning Unit

5 Bands—3.8 to 555 Meters

Especially designed for the Radio Amateur who wants a receiver to cover all the bands. The five, ten, twenty, forty, eighty, one hundred and sixty, and the broadcast band.

Every "proven" development in circuit design is incorporated.

### Some of the Outstanding Features:

Crystal Filter — Beat Frequency Oscillator with cut-out switch and pitch control — Noise Silencer Circuit — Variable Electrical Band Expansion — Amplified A.V.C. — Variable Sensitivity Control — FERROCART (Iron-Core) I.F. Transformers — Audio Volume Control — Fourteen New Metal Tubes — P.P. Output using the new "Beam" 6L6 Metal Tubes — Five Bands 3.8 to 555 Meters.

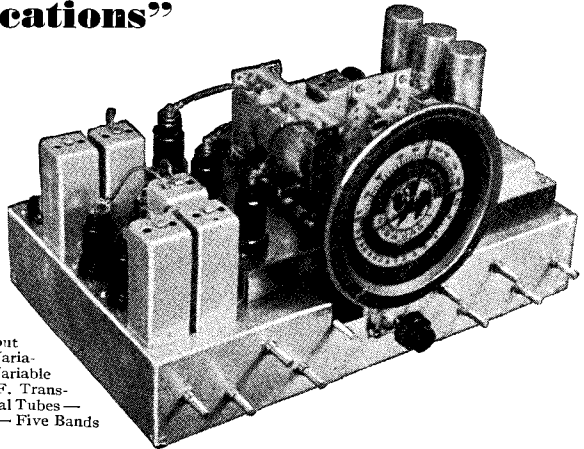

The complete Coil Kit consists of the following: Completely wired tuning unit as described above. Noise Silencer I.F. Transformer. Beat Frequency Oscillator Transformer. Matched Pair of Crystal Filter Transformers. FERROCART (Iron-Core) I.F. Output Transformer. Band Expansion I.F. Transformer. FERROCART (Iron-Core). 6 Shielded R.F. Chokes. Complete set of diagrams and instruction sheets.

Kit No. 7502 — Complete as described above. . . . . List \$50.00

### Completely Wired Tuning Unit Only

The completely wired and accurately balanced and aligned tuning assembly. Includes the Meissner multi-wave coil assembly, band-change switch, variable gang condenser, tube sockets for tuning unit (3), and a calibrated 6" Aeroplane dial with "Micromaster" mechanical band spread.

Model No. 7512. . . . . List \$35.00

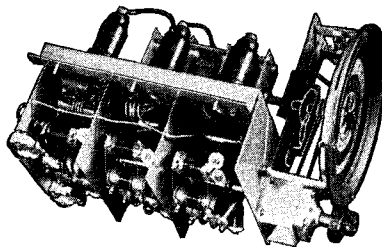

# McGRAW-HILL Radio Books

NEW—

## Practical Radio Communication

Principles — Systems — Equipment — Operation;  
Including Short-wave and Ultra-short-wave Radio

754 pages, 6 x 9, 435 illustrations, flexible, \$5.00

By Nilson and Hornung, well-known radio experts, instructors, writers. This book covers the requirements for all classes of radio operator's license examinations, treats long, medium, short, and ultra-short-wave radio, includes all classes of radio stations — is in general a complete text on practical radio communication based on a theoretical introduction.

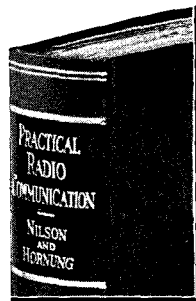

*Examine  
these books  
for 10 days  
on approval*

*Use this book to get ahead in practical radio operating*

- gives full treatment radio and electrical principles; delves deeply into alternating currents.
- particular attention to broadcasting; Western Electric broadcast transmitter; studio acoustics and apparatus, control-room equipment and operation; special diagrams, etc.
- section on ultra-short-wave equipments, for police operators.
- radio-telegraphic and radio-telephonic treatment aviation radio; aircraft transmitters, receivers, testing and maintenance.
- marine medium-frequency equipment, high-frequency transmitters and receivers; direction-finders, etc.
- rectifiers; generators; batteries, etc.

### Nilson and Hornung — RADIO OPERATING QUESTIONS AND ANSWERS

Gives 600 questions typical of all classes of radio operator license examinations, with answers. Covers transmitting, receiving, power-supply, general theory, and laws and regulations, relating to marine, broadcasting, police, aeronautical, and amateur radio. 427 pages. \$2.50

### Henney — RADIO ENGINEERING HANDBOOK

Thorough, professional, authoritative handbook providing technical data on all fields and aspects of radio engineering. 583 pages. \$5.00

### Terman — RADIO ENGINEERING

Analyzes electrical circuits and vacuum tubes and reduces them to quantitative relations that predict with accuracy the performance of radio circuits and radio apparatus. 750 pages. \$5.00

### Hund — HIGH FREQUENCY MEASUREMENTS

Thorough discussion of high frequency phenomena applied to measurements, suitable for research workers and students. 491 pages. \$5.00

### Moyer and Wostrel — RADIO HANDBOOK

Complete digest of authoritative radio data, theoretical and practical, in one conveniently-arranged, fully-illustrated volume. 886 pages. \$5.00

### Moyer and Wostrel — RADIO RECEIVING AND TELEVISION TUBES

Practical manual describing the action of electronic tubes and their application in radio receiving and transmitting apparatus, electric television, control of industrial processes, precision measurements, etc. Third edition. 635 pages. \$4.00

### Moyer and Wostrel — RADIO CONSTRUCTION AND REPAIRING

Clear, simple treatment of construction, installation, testing, and repair of radio receiving sets, including television and short-wave sets. 444 pages. \$2.50

### Henney — ELECTRON TUBES IN INDUSTRY

Practical electronics, with emphasis on what the electron tube is doing toward making processes simpler, cheaper, safer, or in making possible new methods of control of manufacture. Second edition. \$5.00

### Bouck — MAKING A LIVING IN RADIO

Frank survey of radio fields, technical and non-technical, outlining occupational and remunerative possibilities, how to train for jobs, how to get a start, etc. 220 pages. \$2.00

#### SEND THIS McGRAW-HILL ON-APPROVAL COUPON

McGRAW-HILL BOOK CO., INC., 330 W. 42nd St., New York, N. Y.

Send me the books checked below, for 10 days' examination on approval. In 10 days I will pay for the books, plus few cents for postage, or return them postpaid. (We pay postage on orders accompanied by remittance.)

- |   |   |
|---|---|
| <input type="checkbox"/> Nilson and Hornung — Practical Radio Communication, \$5.00         | <input type="checkbox"/> Moyer and Wostrel — Radio Receiving and Television Tubes, \$4.00 |
| <input type="checkbox"/> Nilson and Hornung — Radio Operating Questions and Answers, \$2.50 | <input type="checkbox"/> Moyer and Wostrel — Radio Receiving Tubes, \$2.50                |
| <input type="checkbox"/> Henney — Radio Engineering Handbook, \$5.00                        | <input type="checkbox"/> Moyer and Wostrel — Radio Construction and Repairing, \$2.50     |
| <input type="checkbox"/> Terman — Radio Engineering, \$5.00                                 | <input type="checkbox"/> Henney — Electron Tubes in Industry, \$5.00                      |
| <input type="checkbox"/> Hund — High Frequency Measurements, \$5.00                         | <input type="checkbox"/> Bouck — Making a Living in Radio, \$2.00                         |
| <input type="checkbox"/> Moyer and Wostrel — Radio Handbook, \$5.00                         |   |

Name .....

Address ..... Position .....

City and State ..... Company ..... QSH-37

(Books sent on approval in U. S. and Canada only)

# CP-60 (80-100 Watts) Crystal Controlled C.W. Transmitter

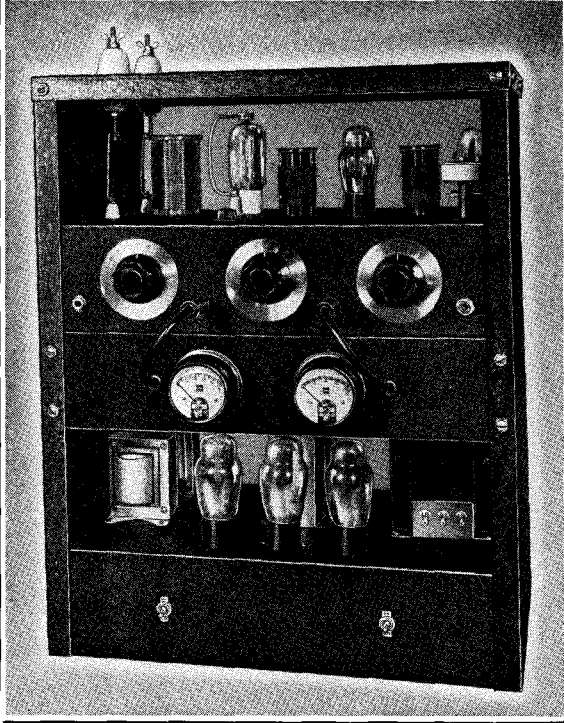

- Tube lineup, 1-6J7, crystal osc., new 6L6 buffer, new Eimac 35T final amplifier
- Band coverage 1.7-3.5-7-14 mc
- Extremely low capacity final and buffer neutralization circuit (2 mmf.)
- Rugged power supply
- Four position meter readings

The CP-60 is a low cost high powered CW transmitter of extremely compact design. The R.F. unit incorporates a 47 crystal oscillator, 6L6 buffer and Eimac 35T final. Meter readings may be taken at four positions, oscillator plate current, buffer plate current, final grid current and final plate current. The extremely low internal capacities of the 6L6 buffer and 35T final permit heretofore unattainable ease of neutralization. The neutralizing condensers are only 2 mmf. and were specially designed for this unit.

The power supply employs three 5Z3 or 83 rectifiers in a special circuit. Sufficient voltage for maximum output is assured.

The CB-80 which is a special combination of the CP-60 and L-60 modulator, in one rack, will soon be released. Write in for advance information.

- Complete CP-60 Kit, less tubes and crystal..... **\$59.50**
- Matched set of Sylvania and Eimac tubes..... **11.00**
- Choice of any one band coils included with kit
- Other bands, per set of three coils..... **2.85**
- The CP-60 is also available completely wired and tested.

## L60 Beam Power (60 Watt) Modulator

- 4 stages (1-6J7, 2-6C5, 2-76, 2-6L6, 1-45, 1-83)
- Push Pull second stage and driver for high fidelity
- Two channel, high and low gain high impedance inputs
- Built-in modulation transformer
- Fixed bias

This beam powered 60 watt modulator will 100% plate modulate transmitters with up to 120 watts input. The built-in modulation transformer will match R.F. loads of 5000, 8000, and 10,000 ohms. On special order we can supply this unit with output impedances of 4, 8, 15, 500 ohms for general public address work.

A two channel input permits full output with mixing from a crystal, ribbon or carbon mike. The tone control provided is used to attenuate voice or music frequencies to suit the requirements of best modulation. Chassis size: 19" x 11" x 4 1/2". Weight 50 lbs. Built-in extra heavy duty power supply.

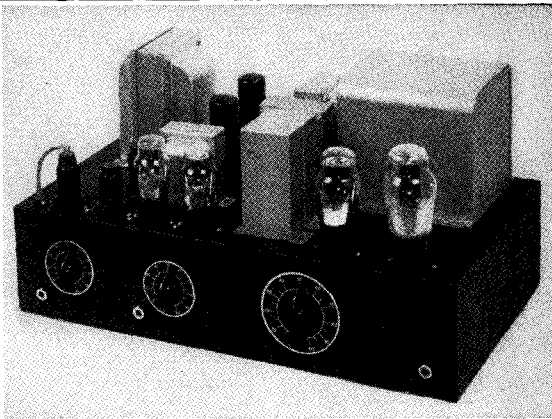

Completely wired and tested in our lab., less **\$42.50**  
tubes.....  
Matched set of Sylvania tubes.....**\$5.50**

## NEW! "THE STANDBY" (2 to 2000 Meters) 3 TUBE A.C. AND D.C. RECEIVER

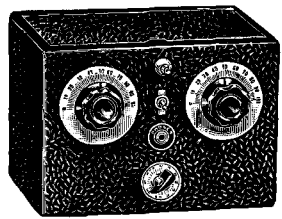

This excellent 2 to 2000 meter receiver is offered with full realization of the present-day need of the amateur for a dependable "standby" receiver which will cover practically all of the radio bands in use today. Super regeneration, which is the most efficient form of detection at these frequencies, is used from 2 to 15 meters. By throwing a toggle switch, straight regeneration and higher wavelengths up to 2000 meters may be had. Throughout the entire tuning range, there are no skips or dead spots. Loud speaker volume is available from practically every station received.

- 1000 to 1 tuning ratio
- Instant change over from straight to super regeneration
- Power supply incorporated
- Individual antenna tuning for high and low wave ranges
- 1-76 super regenerative detector, 1-6J7 regenerative detector, 1-12A7 audio amp. and rectifier
- Super regeneration below 15 meters

- Complete kit of parts less coils, tubes, cab. . . . **\$7.59**
- 2-5-10 meter coils (set of 3) . . . . . **.95**
- 9 1/2 to 15 meter coil. . . . . **.39**
- 15-200 meter coils (set of 4) . . . . . **.95**
- 200-310 meter coil. . . . . **.39**
- 310-350 meter coil. . . . . **.39**
- 550-1050 meter coil. . . . . **.60**
- 1000-2000 meter coil. . . . . **.60**
- Metal cabinet . . . . . **1.50**
- Kit of three tubes. . . . . **2.40**
- Wired and tested in our lab., additional . . . . . **2.00**

**WRITE IN FOR FREE NEW CATALOG ON HAM AND P.A. EQUIPMENT**

20% DEPOSIT WITH ALL C. O. D. ORDERS      REMIT BY M. O. INCLUDE POSTAGE      Cable Address: GROSSINC

**GROSS RADIO, INC., 51 VESEY STREET, NEW YORK CITY, N. Y.**

# Taylor Tubes

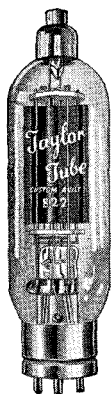

## MORE WATTS *per dollar*



Transmitting tubes are rated by the number of watts the tubes will dissipate and tubes should be operated within that rating. Overloading of tubes was necessary a few years back because it was cheaper to blow up a 210 at \$7.00 than it was to purchase a 203-A at a cost of \$25.00. There were no tubes between the 210 and 203-A at that time.



TAYLOR TUBES, INC. was organized with a definite aim. To give the Amateur Radio Experimenter more tube value for his dollar and to produce new type tubes that were so vitally needed to fill the gaps between the tubes then on the market. In the TAYLOR line you will find a wide range of power ratings at such reasonable prices that it is no longer economical to overload tubes. We firmly believe that TAYLOR TUBES were largely responsible for the intermediate power tubes that are now available to the Amateurs. Proper choice of tubes for your particular circuit and operation within their ratings, will give you longer tube life, thereby cutting down your replacement cost.

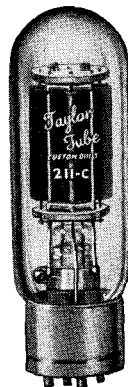

There are over 50,000 TAYLOR TUBES in use today in all parts of the world. THERE MUST BE A REASON.

### Free

*Have you received our tube manual catalog? If not, write for one. It contains valuable technical information and is sent to you without cost. Drop your request in the mail today.*

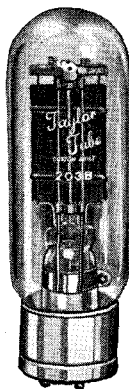

## Taylor Tubes, Inc.

2341 Wabansia Avenue  
CHICAGO, ILLINOIS

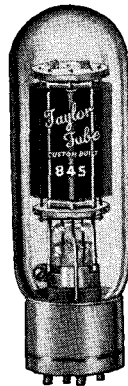



# Taylor **CUSTOM BUILT** Tubes

## MORE WATTS *per dollar* with TAYLOR CARBON ANODE TUBES

Over 50,000 satisfied users prove TAYLOR TUBES are superior. Pick a TAYLOR TUBE to serve your purpose.

TYPE	USE	PLATE DISSIPATION WATTS	PRICE
T-200	Osc. & RF Amplifier . . . . .	200	\$21.50
T-155	H.F. Osc. & RF Amplifier . . . . .	155	19.50
822	RF Amp. & Class "B" Mod. . . . .	200	18.50
814	Osc. & RF Amp. . . . .	200	18.50
HD-203-A	General Purpose Tube . . . . .	150	17.50
203-A	General Purpose Tube . . . . .	100	12.50
845	Audio Amp. . . . .	100	12.50
211	General Purpose Tube . . . . .	100	12.50
211-C	H.F. Osc. & RF Amp. . . . .	100	12.50
203-B	Class "B" Mod. . . . .	50	7.50
T-55	H. F. General Purpose Tube . . . . .	55	8.00
841-A	General Purpose Tube . . . . .	50	7.00
756	General Purpose Tube . . . . .	40	4.95
825	General Purpose Tube . . . . .	40	4.95
866	H.W.M.V. Rect. 2½ volts 5 amps. . . . .		1.65
866-B	H.W.M.V. Rect. 5 volts 5 amps. . . . .		3.00
872	H.W.M.V. Rect. 5 volts 10 amps. . . . .		12.00

*Fully Guaranteed*

# Taylor Tubes

CHICAGO, ILLINOIS

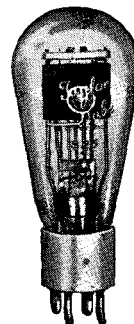
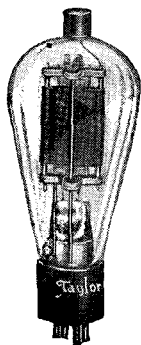
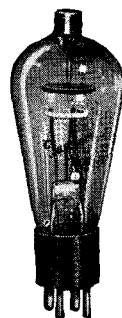
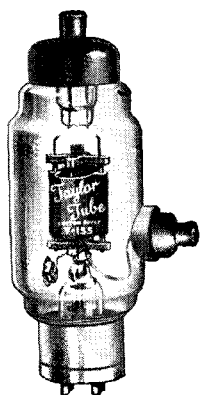
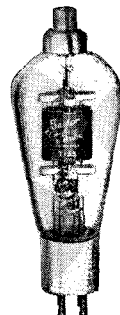
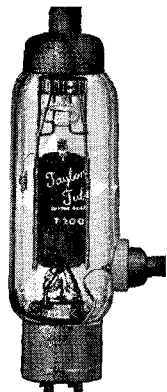



*Most Complete Transformer  
 Line in the World*

**QUALITY • RELIABILITY**

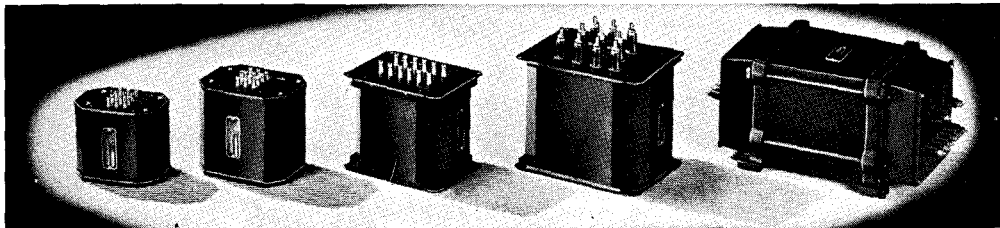

VM-1

VM-2

VM-3

VM-4

VM-5

## *Don't Forget ...* the **NEW UTC VARIMATCH** Modulation Transformer will Match **ANY** Modulator Tubes to **ANY** RF Load . . . .

The Varimatch transformer will not only match PRESENT available modulator tubes, but any tube that may be released at a FUTURE date.

All you have to decide is the DC input to your RF stage. Then just pick the VARIMATCH output transformer that will handle the maximum audio power required.

These transformers will also match the line impedance output of PA or similar amplifiers direct to the Class C tubes.

**VM-1** Will handle any power tubes to modulate a 20 to 60 watt Class C stage. Maximum audio output 30 watts.

**VM-2** Will handle any power tubes to modulate a 40 to 120 watt Class C stage. Maximum audio output 60 watts.

**VM-3** Will handle any power tubes to modulate a 100 to 250 watt Class C stage. Maximum audio output 125 watts.

**VM-4** Will handle any power tubes to modulate a 200 to 600 watt Class C stage. Maximum audio output 300 watts.

**VM-5** Will handle any power tubes to modulate a 450 watt to 1 KW plus, Class C stage. Maximum audio output 600 watts.

Net to Hams **\$4.80**

Net to Hams **\$7.50**

Net to Hams **\$12.00**

Net to Hams **\$19.50**

Net to Hams **\$42.00**

The secondaries of all Varimatch transformers are designed to carry the Class C plate current.

## *The Varimatch Transformer Never Becomes Obsolete*

### NEW VARIMATCH INPUT TRANSFORMERS

- |   |                |  |
|---|----------------|--|
|   | Net to<br>Hams |  |
| <b>PA-49</b> Push pull 45, 59 or 6L6 plates to push pull 845A prime grids. PA-2 .....   | <b>\$4.50</b>  |  |
| <b>PA-50AX</b> Single 53, 56, 6C5, 6C6 triode, 6A6 to Class B 53, 6A6 or 6E6 grids or single 89 to Class B 89 grids. PA-1 .....   | <b>3.30</b>    |  |
| <b>PA-51AX</b> Single 46 or 6L6 to Class B 46 or 59 grids. Single 45, 59, 2A3 or 6L6 to Class B 46 or 59 grids. Single 49 to Class B 49 grids. Single 37, 76, 6C6 or 6C5 triode to Class B 19 or 79 grids. Single 30 to Class B 19 or 79 grids. Single 89 to Class B 19 or 79 grids. Single 2A5, 42, 45 triode plate to A prime 45's, 2A5's or 42's. PA-1 ..... | <b>3.30</b>    |  |
| <b>PA-52AX</b> Push pull, 45, 59, 2A3 or 6L6 plates to 2-46 Class B grids. Push pull 45, 59, 2A3 or 6L6 plates to 4-46 or 59 Class B grids. Push pull 2A3's to 2-841 Class B grids. PA-2 .....  | <b>3.90</b>    |  |

- |  |                |
|--|----------------|
|  | Net to<br>Hams |
| <b>PA-53AX</b> Push pull 42, 45, 50, 59, 2A3 or 6L6 plates to two 210, 801, RK-18, 35T or 800 Class B grids. Push pull 2A3 plates to two 838, 203A, 50T, 35T, 211A, 242A, 830B, 800, RK-18, 801 or 210 Class B grids. PA-2 .....   | <b>\$4.50</b>  |
| <b>PA-59AX</b> 500, 200 or 50 ohm line to two 805, 838, 203A, 830B, 800, RK-18, 801 or 210 Class B grids .....   | <b>4.50</b>    |
| <b>PA-238AX</b> Push pull parallel 2A3, 45, 50, 59 or 6L6 to four 805, 838, or 203A Class B grids. Push pull parallel 2A3, 45, 50, 59, 6L6 or two 211A, 845 plates to Class B 204A, HF-300 or 849 grids. Push pull parallel 2A3, 45, 50 or two 50T, 211A, 845 plates to Class B 150T or HF-200 Class B grids. PA-3 ..... | <b>10.50</b>   |
| <b>PA-512</b> 500, 200 or 50 ohm line to two 150T, HF-300, HF-200, 204A or 849 Class B grids. PA-3 .....   | <b>12.00</b>   |

# Power to spare . . .

Built-in integrity that Hamdom associates with every UTC product... at prices that every Ham can afford...

## the *New* UTC PLATE TRANSFORMERS are superior and do not cost any more

ASK YOUR UTC DISTRIBUTOR FOR THESE UNITS

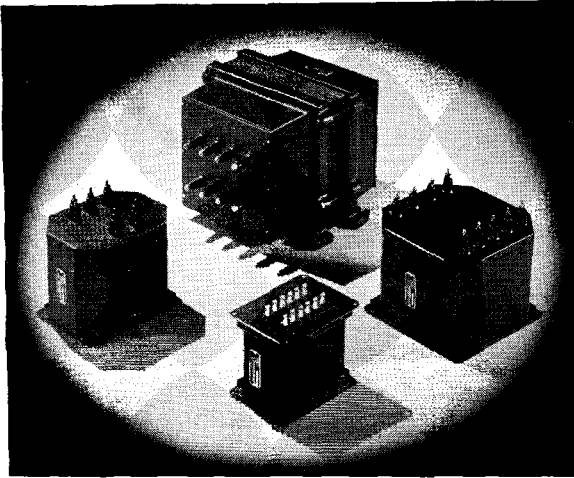

HIGHER VOLTAGES, more current at no increase in cost! Primary 105, 115, 220, 230 volts A.C. 50/60 cycles.

		Net to Hams
PA-110	515 or 625 each side of center at 200 MA 400 VDC or 500 VDC. PA-3	\$ 6.00
PA-111	750 or 950 each side of center at 350 MA; DC voltage 600 or 750. PA-4	10.80
PA-112	1250 or 1500 each side of center at 500 MA; DC. voltage 1050 or 1250. PA-6	21.00
PA-113	1750 or 2100 each side of center at 500 MA; DC. voltage 1500 or 1750. PA-6	28.50
PA-114	1750, 2350, 3000 or 3500 each side of center at 500 MA; DC. voltage 1500, 2000, 2500 or 3000. UTS mtg.	45.60
PA-154	3500, 4000 each side of center at 500 MA 3050 VDC or 3500 VDC. UTS case	60.00
PA-115	C bias plate transformer for class B 203A's, 830B's, 800's, or 210's using one or two 82 rectifiers. PA-3	6.00
PA-116	1250 or 1500 each side of center at 300 MA; DC. voltage 1050 or 1250. PA-5	15.00
PA-117	3500 or 3000 each side of center at 1 ampere. 2620 VDC or 3050 VDC. UTS case	69.00
PA-118	1750 or 2400 each side of center at 325 MA; DC. voltage 1500 or 2000. PA-6 mtg.	23.40
PA-119	1500 or 1750 each side of center at 1 amp. DC voltage 1250 or 1500. UTS case	45.60

NOTE: For reduced power operation, and when required, using these transformers on the 115 volt line, the DC output voltage can be reduced to half of normal value by switching to the 230 volt tap. These transformers will also operate on 25 to 40 cycle current if the 115 volt line is connected to the 230 volt tap.

NOTE: CS types are similar in appearance and design to PA types of like voltages and current but differ from PA types in that they are designed ONLY for operation on 115 volt 50/60 cycle current.

		Net to Hams
CS-200	450 each side of center at 150 MA; 5V-3A; 2 1/2 V-10A. CV mtg.	\$ 3.90
CS-201	500 each side of center at 200 MA; 2 1/2 V.C.T. 14 A; 5 V.C.T. 3 A; CD mtg.	4.80
CS-202	600 each side of center at 200 MA; 2 1/2 V-10A; 7 1/2 V-3A; 5V-3A. CD mtg.	6.00
CS-203	800 each side of center at 150 MA; 660 V. P.S. CD mtg.	4.50
CS-204	800 each side of center at 250 MA; 650 V. DC. CD. mtg.	6.60
CS-205	750 or 950 each side of center at 350 MA; DC. voltage 600 or 750. PA-4 mtg.	10.20
CS-206	1250 or 1500 each side of center at 500 MA; DC. voltage 1050 or 1250. PA-6 mtg.	19.20
CS-207	1750 or 2100 each side of center at 500 MA; DC. voltage 1500 or 1750. PA-6 mtg.	26.10
CS-208	1750, 2350, 3000 or 3500 each side of center at 500 MA; DC. voltage 1500, 2000, 2500 or 3000	39.00
CS-209	1250 or 1500 each side of center at 200 MA; DC. voltage 1050 or 1250. PA-5 mtg.	12.00
CS-210	1750 or 2400 each side of center at 325 MA; DC. voltage 1500 or 2000. PA-6 mtg.	21.00
CS-212	475 each side of center at 500 MA; 5 V.C.T. 6A, for 4-6L6's fixed bias etc. DC. voltage 400 CD mtg.	8.40
CS-213	1250 or 1500 each side of center at 300 MA; DC. voltage 1050 or 1250. PA-5 mtg.	13.80
CS-214	1500 or 1750 each side of center at 1 amp. DC. voltage 1250 or 1500. UTS mtg.	39.00

# UNITED TRANSFORMER CORP.

72 SPRING STREET

NEW YORK, N. Y.

EXPORT DIVISION: 100 VARICK STREET NEW YORK, N. Y. CABLES: "ARLAB"

# Popular Western Electric Tubes for amateur use!

## For Ultra High Frequency

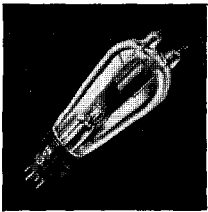

**304B** Upper frequency  
**TRIODE:** limit—300 megacycles. Maximum voltage—1250 volts. Nominal power output, Class C—unmodulated—**\$12.50** 85 watts. **in U. S. A.**

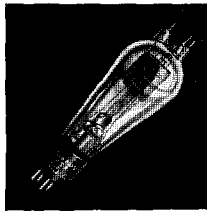

**305A** Full ratings  
**SCREEN GRID:** up to 50 megacycles. Maximum voltage—1000. Nominal power output, Class C—unmodulated—**\$38.50** 85 watts. **in U. S. A.**

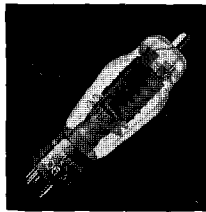

**306A** Full ratings up  
**PENTODE:** to 50 megacycles—reduced ratings up to 70 megacycles. Maximum voltage—300 volts. Maximum power **\$10.80** output 8.8 watts. **in U.S.A.**

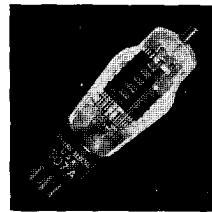

**307A** Full ratings up  
**PENTODE:** to 40 megacycles—reduced ratings to 70 megacycles. Maximum voltage—500 volts. Carrier power out—**\$13.65** put—20 watts. **in U. S. A.**

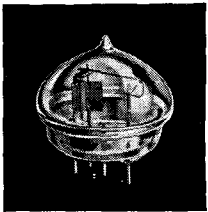

**316A** Upper frequency  
**TRIODE:** limit—750 megacycles. Maximum voltage—450 volts. Nominal power output at 500 megacycles—7.5 **\$10.50** watts. **in U. S. A.**

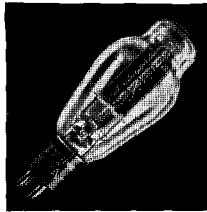

**300A** High quality audio. Maxi-  
**TRIODE:** mum voltage—450 volts. **\$9.75** Maximum output—17.8 watts. **in U.S.A.**

**FOR  
AUDIO  
FRE-  
QUENCY**

**POWER  
AMPLI-  
FIER**

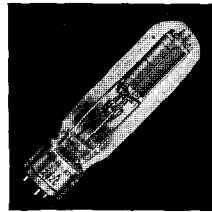

**242C** Maximum voltage—1250 watts.  
**TRIODE:** Approximate carrier output, Class B, 100% modulated—50 watts. 100% Modulated Class C nomi- **\$15.00** nal power output—130 watts. **in U.S.A.**

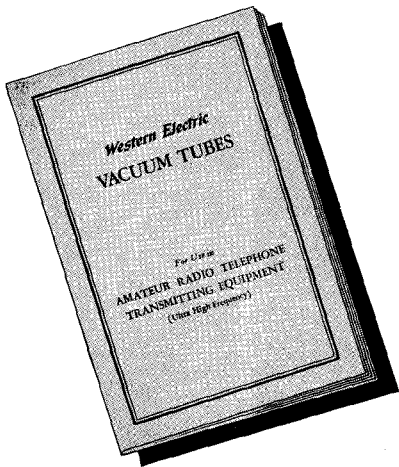

Write to distributors listed below for booklet giving detailed information and characteristics of the 304B, 305A, 307A, 316A and 300A tubes — Data sheets available on 306A and 242C.

## Western Electric BROADCASTING EQUIPMENT

Distributors:

Graybar Electric Company, Graybar Building, New York  
In Canada: Northern Electric Co., Ltd., 1261 Shearer St., Montreal, P. Q.

In other foreign countries:

International Standard Electric Corporation, 67 Broad Street, New York, N. Y.

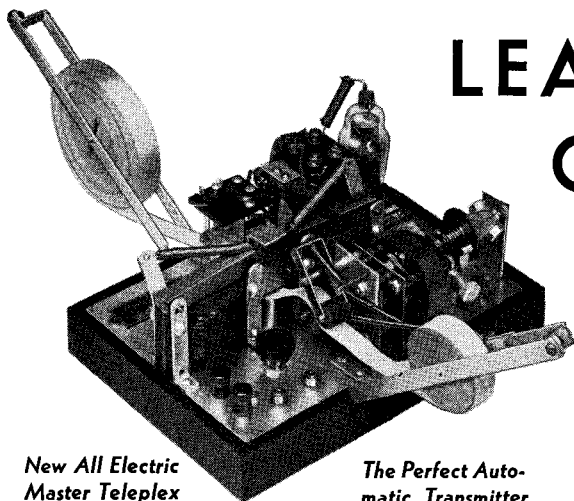

*New All Electric  
Master Teleplex*

*The Perfect Auto-  
matic Transmitter*

# LEARN CODE

*the way you'll  
be using it*

# BY SOUND

There is only one way to learn to read code and that is by listening to code. There is only one proper way to learn to send code and that is by hearing your own sending repeated back to you. With the Master Teleplex Code Teacher you learn code the natural, easy, fascinating way. Only instrument ever produced which records your sending in visible dots and dashes—then SENDS BACK your own key work at any speed you desire. Master Teleplex is the only way you can learn the code and check your progress. We furnish complete course, lend you the New All Electric Master Teleplex, give you personal instruction with a **MONEY BACK GUARANTEE**—all at a surprisingly low cost per month. Write today for **FREE** catalog QH. No obligation.

## TELEPLEX CO.

72-76 Cortlandt Street

New York, N. Y.

### "HAM" SPECIAL STANDARD TELEPLEX

A highly efficient code teacher using heavy specially prepared waxed paper tape, having two rows of perforations. Preferred by thousands of hams, because they receive signals under actual working conditions. Write for Free folder QA.

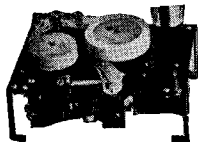

Instrument, with tapes prepared by expert and complete course of lessons: **\$11.95** all for.....  
Without Oscillator

DEALERS — Correspondence invited with dealers for protected territories.

TELEPLEX CO.

Dept. QH, 72-76 Cortlandt St., New York, N. Y.

Please send me Free Catalog and details of your money-back guarantee.

NAME.....

STREET.....

CITY..... STATE.....

# FOR ACCURACY

## SANGAMO MICA CONDENSERS



Type D Condensers. Actual size.  
 Available in capacities from .00004  
 to .0005.



Type C Condensers. Actual size.  
 Available in capacities from .00004  
 to .003.

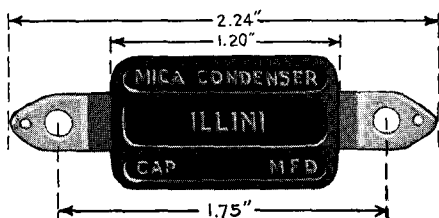

Type B-10 Condensers. Available  
 in capacities from .00005 to .01.  
 Also available in 2500 v. test, ca-  
 pacities .00005 to .002.

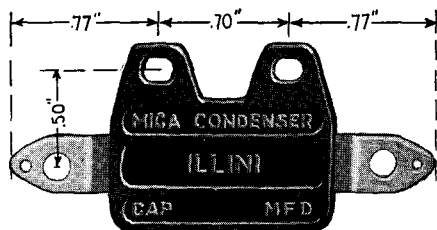

Type BE-10 and BE-25 Condensers,  
 supplied with insulated mountings  
 as shown.

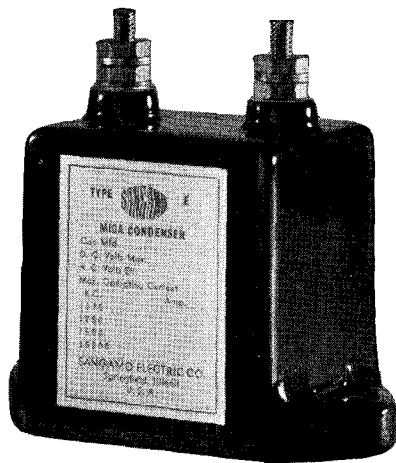

### TYPE E PORCELAIN CASE CONDENSERS

Available in capacities  
 from .00005 to 0.1, volt-  
 ages up to 12,500.

ALL RATINGS LISTED IN OUR  
 NEW BULLETIN—WRITE FOR IT

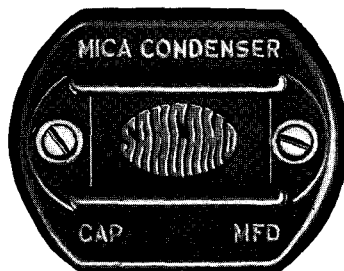

Type A Condensers - the ac-  
 cepted standard for precision  
 work. Supplied in 1000,  
 2500 and 5000 volt ratings.

**SANGAMO**  
 ELECTRIC COMPANY  
 SPRINGFIELD, ILLINOIS

## RME - 69

RELAY RACK MODEL,  
combining all component parts  
in one compact cabinet . . . re-  
ceiver, speaker, cords. Satin  
aluminum or crinkle black finish  
optional.

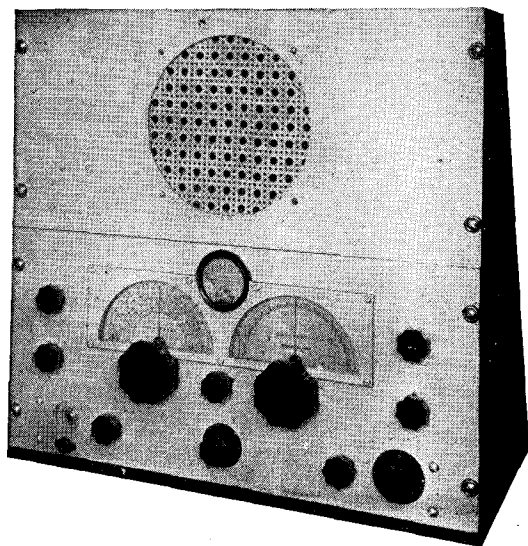

# INDIVIDUALIZED

WRITE FOR BULLETIN  
NO. 69 and PRICES

The 1937 RME-69 Single Signal Super-receiver, represents the very last word in radio engineering achievement. Outstanding both in appearance and performance, it is truly a precision instrument. Being the product of an engineering laboratory, RME-69 may be ordered equipped with certain accessories for your own special requirements . . . an advantage not obtainable in mass-production instruments. Our Bulletin will tell you what special adaptations may be provided for your individual station layout. And remember . . . *you must be satisfied.*

# RME - 69

## RADIO MFG. ENGINEERS INC.

306 First Avenue, Peoria, Illinois

# The Mueller Line

## TEST and BATTERY CLIPS ALL SIZES FOR ALL PURPOSES

Stocked by Jobbers Everywhere



No. 45-C

### SOLID COPPER RADIO FREQUENCY TEST CLIP

Equipped with phosphor bronze spring and brass screw. ENTIRELY NON-FERROUS and ideal for use on transmitters. Will not heat up on high frequency circuits. Jaw spread  $\frac{1}{4}$ ".



No. 85 Clip with No. 87 Insulator

### ALLIGATOR CLIP and RUBBER INSULATOR

Long, slender jaws will make contact in cramped quarters. Teeth really mesh on both sides and front end. Both screw and barrel connection.  $2\frac{3}{8}$ " long. Jaw spread  $\frac{1}{2}$ ".

Insulators furnished separately — one half red and one half black.



No. 45 Pee Wee

A very small test clip for radio and electrical work. For making connection to dry cells, meters and helices. Teeth on both jaws which mesh. 5 Amperes.  $1\frac{1}{2}$ " long. Jaw spread  $\frac{3}{8}$ ".



No. 48-B

A small test and battery clip for connections to B batteries and for general test purposes. Teeth mesh. 5 Amperes. 2" long. Jaw spread  $\frac{9}{16}$ ".



No. 27

A high grade test clip for use on meters, in laboratories, testing devices, etc. Teeth mesh on three sides of jaws. 10 Amperes.  $2\frac{1}{4}$ " long. Jaw spread  $\frac{3}{16}$ ".



No. 24-A

A medium sized clip for connections to storage batteries. Heavy, flanged construction. Lead Plated. Copper shunt protects spring. 25 Amperes.  $2\frac{7}{8}$ " long. Jaw spread 1".

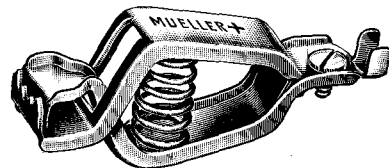

No. 21-A  
4" long. Jaw Spread  $1\frac{1}{4}$ ".

A heavy duty, lead plated battery clip. Also used for ground connections. 50 Amperes.

No. 11-A — 100 Ampere, Lead Plated Clip.



No. 99

### SNAPPER

An insulated, elongated test clip. Spring jaws are operated by a push of the thumb on the opposite end. 7" long. Will reach into inaccessible spots. May also be used as a prod or a retriever. Packed two in a box, 1 red and 1 black.

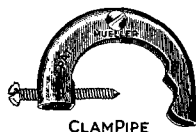

CLAMPIPE

### CLAMPIPE GROUND CLAMP

Patented, channelled construction gives 5-point contact with great strength and rigidity. Screw is hardened. All cadmium plated. The best ground clamp made. Takes pipe up to  $1\frac{3}{4}$ " outside diameter.



### RUBBER INSULATORS FOR CLIPS

Rubber insulators, one half red and one half black are made to fit each size of Mueller Clip.

They are constructed so that clips cannot slip forward or back and the long tail forces the wire to bend in an arc thus preventing breakage. A convenient protection against short circuit and shock.

Just give the number of the clip you want the insulator to fit.

### SOLID COPPER CLIPS

All sizes of Mueller Clips are also offered made of copper with steel screws and steel springs.

Specify ampere capacity wanted.

Ask for Catalog 683 for Further Details

### PRICES

Assort Any Products to Obtain Quantity Prices

CODE NO.	Price
11-A steel clip	\$.50
21-A steel clip	.17
24-A steel clip	.10
26 Insulator for 24-A	.20
27 Steel clip	.12 $\frac{1}{2}$
29 Insulator for 27	.11
45 Steel clip	.05
45-C Copper clip	.10
47 Insulator for 45	.07 $\frac{1}{2}$
48-B steel clip	.05
58 Ground clamp	.08
99 Snapper	.75
85 Steel clip	.07
87 Insulator for 85	.05

*Mueller Electric Co.*

ESTABLISHED 1908

1583 E. 31st St., Cleveland, Ohio



## HIS CATALOG

covers practically the complete Johnson line for 1936-37. For complete listing, send for Bulletin 961H. Commercial types of inductors and other items such as large fixed and variable air condensers are not shown, and inquiries are solicited. Technical bulletins are available where noted, and will be sent free on request.



A

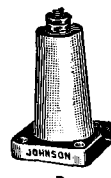

B



C



D



E



F

### STAND-OFF INSULATORS

The original Johnson Stand-Off Insulators are characterized by perfection of ceramic design, logical proportions and range of sizes, accuracy, and, most important, a very superior quality of porcelain and hardware. The new "Bee-hive" and straight side insulators (styles B and C) have unbreakable cadmium plated drawn steel bases and as usual mount in very little space. Jack types are available in many sizes. Specify white or brown glaze.

Cat. No.	Body Height	Hardware	Style	List Price
20	1 9/16"	10-32	D	12¢
20J	1 9/16"	74 Jack	D	15¢
22	1"	8-32	D	8¢
22J	1"	74 Jack	D	12¢
24	5/8"	6-32	D	7¢
60	4 1/2"	1/4-20	A	65¢
62	2 3/4"	1/4-20	A	30¢
65	1 3/8"	10-32	C	20¢
65J	1 3/8"	74 Jack	C	25¢
66	2 3/4"	1/4-20	B	35¢
66J	2 3/4"	76 Jack	B	55¢
67	4 1/2"	1/4-20	B	55¢
67J	4 1/2"	76 Jack	B	75¢

### THRU-PANEL INSULATORS

The carefully worked out line of Johnson Thru-Panel Insulators reflect the same qualities possessed by the Stand-Off types. Low absorption porcelain (highly important in R.F. circuits), smooth glazing; solid brass nickel plated hardware with milled nuts; cushion washers; flat, large area mounting surfaces; longer bottom sections with extended leakage path; soldering terminals on jack types—are features of Johnson design. Specify white or brown glaze.

Cat. No.	Body Top	Body Bottom	Panel Hole	Hardware	List Price
40	1 1/4"	1/2"	1/2"	10-32	25¢
40J	1 1/4"	1/2"	1/2"	74 Jack	30¢
42	7/8"	3/8"	7/16"	10-32	20¢
42J	7/8"	3/8"	7/16"	74 Jack	25¢
44	5/8"	5/16"	5/16"	6-32	14¢
45	1 3/8"	11/16"	9/16"	10-32	30¢
45J	1 3/8"	11/16"	9/16"	74 Jack	35¢
4576J	1 3/8"	11/16"	9/16"	76A Jack	55¢
46	2 3/4"	1"	3/4"	1/4-20	55¢
46J	2 3/4"	1"	3/4"	76 Jack	75¢
47	4 1/2"	1 1/2"	1 1/16"	1/4-20	80¢
47J	4 1/2"	1 1/2"	1 1/16"	76 Jack	\$1.00

45, 45J, and 4576J are Style E, others Style F

### HANDLE INDICATORS

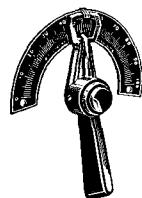

Highly attractive solid molded bakelite controls which enhance the appearance of any equipment. "Window" design makes possible three separate scales if desired. No. 204 has 4" diameter etched scale with polished figures on black background, and fits 1/4" shaft. No. 206 is similar, with 6" scale, fits 1/4" shaft, and has removable bushing for 3/8" shaft.

No. 204. Handle Indicator. List Price \$1.00

No. 206. Handle Indicator. List Price 1.25

### TRANSMITTING TUBE SOCKETS

For many years the accepted "best" for mounting "UX" and "50 Watt" tubes, now also made for 5 prong tubes such as the RK28 and RCA803. All have a heavy polished nickel plated brass shell—a necessity for properly supporting transmitting tubes. Contacts are one piece, of heavy cadmium plated phosphor bronze, and make firm wiping side contact with the tube prongs. Connections may be soldered directly to contact springs. "FB" types are for vertical panel mounting and are enclosed in black finished cast aluminum cases. Bases are of fine quality low absorption porcelain—specify whether white or brown glaze.

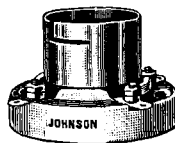

Cat. No.	Type of Tube	List Price
210	"UX" base	\$1.00
210FB	"UX" base	2.50
211	"50 watt"	1.50
211FB	"50 watt"	3.50
216	5 prong	2.50

### "250 WATT" SOCKET SET

A new improved mounting for 204A, 849, and similarly based tubes. Plate terminal has "safety cup," preventing accidental displacement of the tube. White glazed low absorption porcelain bases.

No. 215. "250 Watt" Socket Set. List Price . . . . . \$3.50

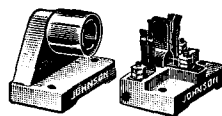

### PLUGS AND JACKS

#### "Banana Spring" Type

Johnson perfected design, nickel-silver springs, and high grade nickeled brass screw machine parts with accurate threads and milled nuts, result in superior plugs and jacks of this popular type. Studs extend full length of springs. 77A Plug is like 77 but has 10-32 screw for mounting on ceramic coil forms, etc.

Cat. No.	Length	Thread	List Price
74 Jack	1 1/16"	1/4-28	6¢
75 Plug	3/4"	6-32	6¢
75A Plug	3/4"	6-32	6¢
76 Jack	1 3/8"	3/8-24	25¢
76A Jack	1 3/8"	1/4-20	25¢
77 Plug	1 1/8"	1/4-28	20¢
77A Plug	1 1/8"	10-32	25¢

\* Lengths do not include screw thread

#### "Spring Sleeve" Type

A Johnson development, to solve the need for mechanically strong, low resistance plugs and jacks, having no "wobble." Made of brass, brightly nickeled, with phosphor bronze spring giving permanent tension and smooth action. Plugs will fit into copper tubing of same size as body, and have holes in threaded ends for soldering leads.

Cat. No.	Length*	Thread	List Price
70 Jack	1 1/2"	1/4-20	35¢
71 Plug	1 1/8"	1/4-28	12¢
72 Jack	1 1/8"	10-32	20¢
73 Plug	1"	10-32	6¢
73A Plug	1"	10-32	6¢

\* Lengths do not include screw thread

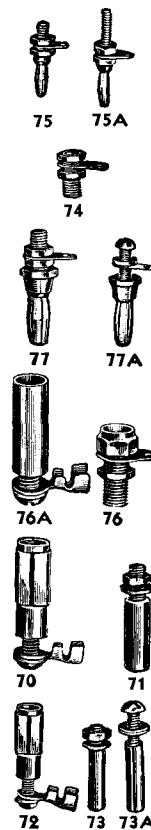

## VARIABLE CONDENSERS

Catalog Number	Plate Spacing	Capacity $\mu\text{f}^*$	List Price
<b>Single Section Models</b>			
50D35		46	\$ 6.50
100D35		100	7.25
150D35	.080"	150	8.00
250D35		250	9.50
350D35		350	11.00
500D35		500	13.25
50D70		50	7.50
100D70		100	9.50
150D70		150	11.50
250D70	.175"	250	15.50
350D70		350	19.75
500C70		500	21.00
50D90		50	9.00
100D90		100	11.00
150D90	.250"	150	13.00
250D90		250	17.00
350C90		350	20.60
50C110		50	9.00
100C110	.350"	100	11.80
250C110		250	20.80
50C130		50	9.90
100C130	.500"	100	14.10
<b>Dual Section Models</b>			
100DD35		100	\$11.00
150DD35	.080"	150	12.50
200DD35		200	14.00
300DD35		300	17.00
70DD70		70	12.50
100DD70		100	14.75
150DD70	.175"	150	18.25
200DD70		200	22.00
50DD90		50	13.25
100DD90	.250"	100	17.25
200CD90		200	25.30
50CD110		50	13.70
100CD110	.350"	100	19.30
50CD130	.500"	50	15.55

\*Capacities given in table are per section.  
New Type "C" numbers are printed in red.

Johnson Condensers have been especially designed for high frequency transmitting — not merely adapted from receiving condenser parts. Careful engineering has made possible extreme values of capacity and plate spacing in comparatively small bulk. Heavy construction is used throughout — in the end plates, tierods, rotor and stator plates, spacers, insulation, bearings, contacts. Genuine MYCALEX and ALSIMAG 196 Ceramic insulation is used — both the finest money can buy — with long path from stator to frame. The most expensive condensers to manufacture, yet averaging with the lowest in price!

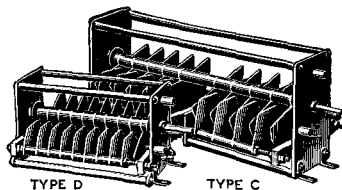

Note the wide plate spacings available in both types "D" and "C", for use with the newer high voltage low C tubes. Special capacities can be furnished promptly. For additional information, obtain Bulletin 201H.

### Note These Unusual Features!

**Heaviest plates**, edges smoothly rounded . . . **MYCALEX and ALSIMAG 196** insulation . . . **Long insulation paths**, few in number . . . **Large laminated rotor brushes** front and rear . . . **Adjustable bi-metallic cone bearings** . . . **Heavy tie rods** for ample protection and frame rigidity . . . **Large diameter shaft and spacers** properly located for stiffness of rotor and stator assemblies . . . **Shafts extended** both front and rear . . . **Insulated tie-rods** eliminating "short-circuit loops" . . . **High capacities and wider spacings** made possible by Johnson design.

### General Specifications

**Material:** Aluminum. Plates .051" thick, edges rounded and polished; ends 1/8" thick; tie rods 5/16" diameter; frame is satin etched finish.

**Shaft:** Steel, cadmium plated, 1/4" diameter, extended 1 1/2" front, 3/4" rear.

**Voltage Ratings:** Approximate peak values.

Spacing	.060"	.080"	.175"	.250"	.350"	.500"
Voltage	2500	3500	7000	9000	11,000	13,000

**Panel Space:** Type "D", 4 1/4" wide x 4" high; Type "C", 5 1/2" wide x 5 3/8" high.

Watch for other new Johnson condensers to appear shortly, featuring:

**Extreme compactness . . . minute losses . . . very low minimum capacities . . . new mechanical design.**

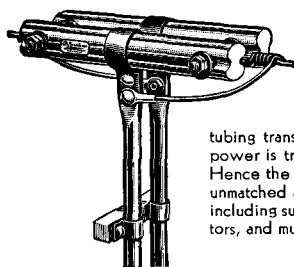

## TYPE "Q" ANTENNA

The Johnson Type "Q" Antenna has achieved outstanding success in high frequency transmitters throughout the world because of its high efficiency. The special quarter-wave tubing transformer accurately matches line and antenna impedances, and power is transferred with practically no losses even with very long lines. Hence the Type "Q" will radiate TWICE as much power as the common unmatched antenna-feeder system. Bulletin 100H gives further information, including suggestions for coupling to the transmitter, use on harmonic radiators, and multiple band operation.

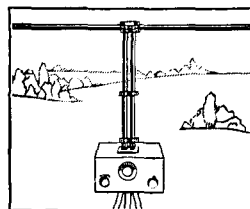

Cat. No.	Amateur Band	List Price
5Q	5 meters	\$ 6.50
5QM	5 meters	9.50
10Q	10 meters	6.25
20Q	20 meters	9.90
40Q	40 meters	17.50
80Q	80 meters	32.75

## SPECIAL 5 METER "Q" ANTENNA

This special form of "Q" antenna for 5 meters is designed for convenient installation with fixed or portable transmitters. May be mounted directly on the transmitter case, or suspended in the air with a transmission line back to the equipment. Impedances remain accurately matched in both cases. Suitable Mycalex insulated fittings are made for convenient line construction, and are described in Bulletin 100H. The 5QM is a special model. Mycalex insulated in place of porcelain.

## ENAMELED COPPERWELD ANTENNA WIRE

Developed for use with the "Q" Antenna, Johnson Enamelled Copperweld Antenna Wire is the ideal material for transmitting doublets, directional antenna systems, and other applications where the wire must not stretch nor sag. It has a steel core, welded to a heavy copper exterior and enamelled, combining high R.F. conductivity, freedom from corrosion, and almost three times the strength of ordinary enamelled copper antenna wire.



Cat. No.	B & S Ga.	Ft. per lb.	Strength	List per ft.
346	8	22	1700 lbs.	4¢
348	10	34 1/2	1130 lbs.	2 1/2¢
350	12	54	720 lbs.	1 1/2¢
352	14	85	400 lbs.	1¢

E·F·JOHNSON·COMPANY

Radio Transmitting Equipment

WASECA · MINNESOTA · U.S.A.

## "HI-Q" INDUCTORS

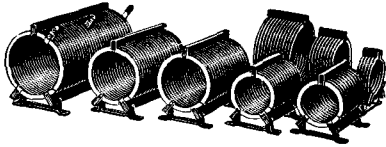

### Impedance Matching Inductors

Inductors No. 610 and No. 611 (formerly 2402HL3 and 2202HL3), while useful for other purposes as well, are designed for use in "pi-section" impedance matching networks for amateur frequencies. Two No. 611, for balanced circuits, or one No. 610, for unbalanced circuits, are used in combination with two variable condensers, either 350D35, or 350D70, and provide an accurate impedance match and hence assure maximum energy transfer from the tank circuit to the line or radiating system.



### Inductor Clips

LC4 Inductor Clips should be used with all "HI-Q" Inductors, since they offer practically zero contact resistance. Made of spring phosphor bronze, nickel plated, with tinned terminal. Should be ordered separately for all except plug-in inductors.

LC4 Inductor Clip, List Price.....20¢

The following Inductor Bulletins are available: "HI-Q" Inductors, Bulletin 351H; Impedance Matching Networks, Bulletin 130H; Commercial Inductors, Bulletin 300H.

\* If dual section condensers are used, each section must be double the indicated capacity.

\*\* "Two Units" refers to two coaxial inductors in series, usually with a coupling coil between, as in balanced tank circuits.

Plug-in and stationary types of HI-Q Transmitting Inductors are ideal for modern amateur transmitters. High electrical efficiency is secured by proper proportions, generous conductor size, and the use of excellent hard rubber insulation correctly applied. Johnson edgewise wound copper (nickel plated) produces inductors unequalled for compactness, rigidity, and ease of adjustment. The flat surface offers excellent contact to the LC4 Clips, which can be accurately placed and readily moved, greatly facilitating coupling adjustments, band changing, retuning, etc. Contrast these points with other types, including wire wound coils with either solid or skeleton forms!

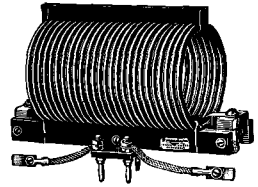

The Plug-in series is so designed that all amateur bands from 10 to 160 meters may be covered with one variable condenser with a maximum capacity of 100 µf. They are equipped with two No. 77 and three No. 75 plugs (two of which attach to flexible leads and LC4 Clips for an integral coupling winding) and mount on two 4576J and three 40J Johnson Insulators (see page 506).

Amateur Band Meters	Tuning Capacity µf *	Inductor**	
		Single Unit	Two Units
160	100	630	
	100	620	622
	200	622	
80	75	632	
	50	622	624
	100	624	626
	200	626	
40	45	634	
	25	624	626
	50	626	628
	120	628	
20	30	636	
	15	626	628
	30	628	
10	25	638	

Cat. No.	µh	Dimensions L x I.D.		List Price
<b>Stationary Types</b>				
610	33	7 3/4"	2 1/2"	\$5.40
611	14	4 7/8"	2 1/2"	3.60
620	88	9"	4 1/2"	6.75
622	44	6 1/2"	3 1/4"	5.15
624	21	6 1/2"	3 1/4"	4.20
626	10	5"	2 1/2"	3.50
628	4.4	4 3/4"	2 1/2"	3.00
†619	20	3 1/4"	4 1/2"	3.35
†623	8.1	2 1/4"	3 1/4"	2.75
†627	2.2	1 1/2"	2 1/2"	2.40
<b>Plug-in Types</b>				
630	74	8"	4"	8.30
632	27	8"	3 1/2"	6.25
634	12	8"	2 1/2"	5.50
636	4.3	8"	2 1/2"	5.10
638	11	8"	2"	4.80

† Generally used as coupling coils with tank coils of like diameters.

‡ Variable by means of end clips.

## ANTENNA INSULATORS

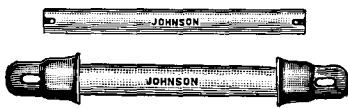

- 107
- 112
- 120
- 151
- 152
- 153

These insulators are of genuine WET PROCESS porcelain with smooth white glazing. The all-porcelain types are 1" in diameter and will stand 1500 pounds pull. Their long leakage path, low capacity, and freedom from moisture absorption result in exceptional efficiency. The new Commercial Type is 1 1/2" in diameter for uses where much greater strength is necessary. The aluminum alloy fittings are non-corrosive.

Cat. No.	Length	List Price	Cat. No.	Length net overall	List Price
107	7"	\$.70	151	8" 15 1/4"	\$ 7.00
112	12"	.90	152	12" 19 1/4"	8.50
120	20"	1.50	153	18" 25 1/4"	12.00

## STRAIN INSULATORS

The No. 32 Airplane Strain Insulator is also very useful for light guys and receiving antennas. The new No. 38 "Cruciform" Strain Insulator is specially designed for R.F. applications, having low capacity, long leakage path, light weight. Both are 1 1/2" long, of white glazed low absorption porcelain.

No. 32 Airplane Insulator. List.....7¢  
No. 38 Strain Insulator. List.....15¢



## TRANSPPOSITION INSULATORS

Much used for both receiving and transmitting feed lines. This original Johnson insulator simplifies installation, weighs very little, does not twist the line, and has high insulating value. White glazed low absorption porcelain.

No. 31. Transposition Insulator. List Price 12¢

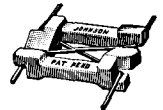

## FEEDER SPREADERS

A new Commercial Feeder Spreader of best WET PROCESS white glazed porcelain. Heavy duty type, 7/16" x 5/8" x 6".

No. 146. Commercial Type Spreader. List Price.....40¢

Cat. No.	Length	List Price
No. 132	2" long.	12¢
No. 134	4" long.	15¢
No. 136	6" long.	20¢

Every amateur transmitting and receiving need is supplied by these new 2", 4", and 6" feeder spreaders. 3/8" x 1/2" cross section, of white glazed low absorption porcelain.

# CRESCENT CORD SETS

*with Parts—Ready to Install*

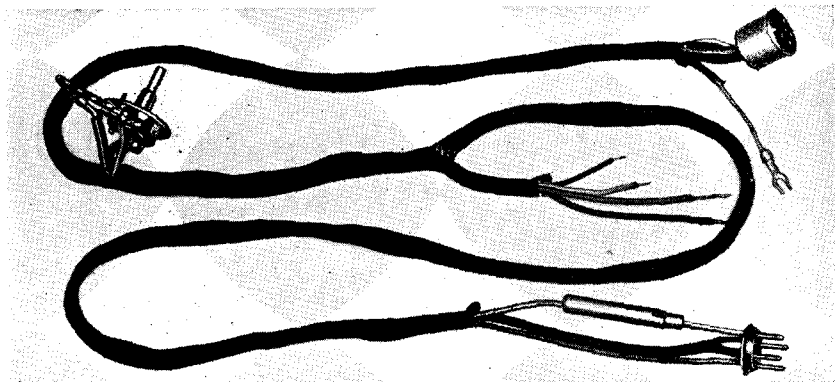

## RADIO MANUFACTURERS

*make big savings with*

## CRESCENT COMPLETE CORD SETS

•  
*The cost of making only a few such cord assemblies is, of course, prohibitive.*

We are making large savings for radio manufacturers by assembling their cords complete with switches, sockets, fittings, etc.

We specialize in this work. Our testing and inspection is complete and we guarantee 100% perfect cords ready for installation. Send us your blue prints for prices on quantity production.

•  
**Receiver Cords**  
**Assembly Cords**  
**Antenna Cords**  
**Shielded Cords**

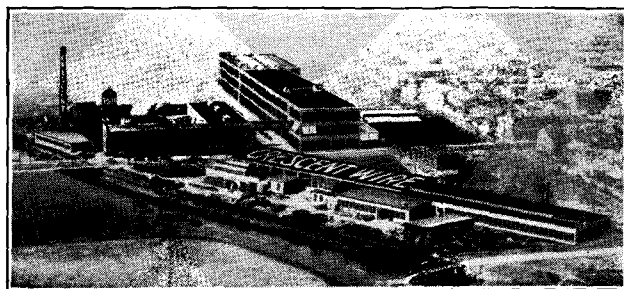

Address Department R. A. D.

**CRESCENT**  
**INSULATED WIRE**  **& CABLE CO. INC.**

TRENTON, NEW JERSEY.

# ultra-high

THE STANDARD FIXED OR MOBILE UNIT FOR OVER A YEAR

## Type TR-6A6

### Duplex Transmitter-Receiver

**General:** Type TR-6A6 Duplex Unit is a medium power Transmitter employing the latest type twin-triodes, unity coupling with the new 6E6 higher efficiency push-pull oscillator and Class B modulation; and a four tube super-regenerative Receiver with tuned r.f. and integral dynamic speaker. It is designed for phone or i.c.w. without the use of external microphone battery or tone. Our laboratory developed the first transceiver using twin-triodes and now offers these compact tubes in an efficient modern duplex unit. Type TR-6A6 has communicated at 100 miles with a high antenna and 35 miles from a moving car.

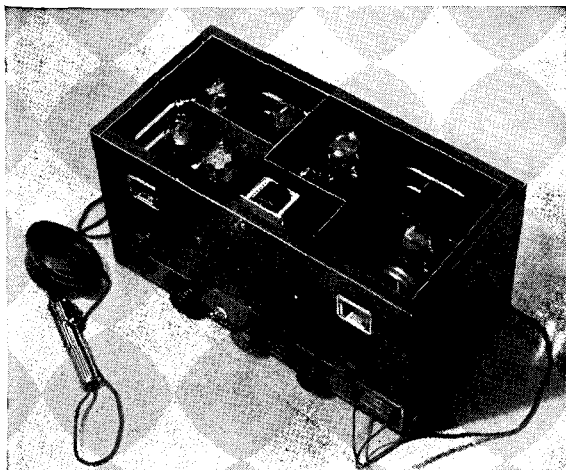

# SPECIAL FEATURES

**Frequency Range:** 56 Mc to 60 Mc tuned by a Cardwell isolantite insulated condenser and vernier dial. Also supplied for 30 to 41 Mc experimental frequencies.

**Duplex Operation:** Duplex or break-in operation is two way transmission and reception similar to that of a land telephone circuit. The operator talks and listens without throwing a switch and he may interrupt the conversation at will, or "break-in." A panel switch knob is provided for turning off the transmitter when listening on the transmitting frequency. Provision for headphones is incorporated.

**Carrier Power:** 7 watts; 28 watts on peaks.

**Microphone:** A single button microphone of the highly damped type should be used in order to avoid acoustic feedback between speaker and microphone. No microphone battery is required.

**I.C.W.:** A jack for the insertion of key leads for code transmission is incorporated. No external tone is required.

**Power Supply:** Transmitter and receiver are separate units completely shielded from each other, and each has its own power supply socket. The unit may be installed with individual power supplies for transmitter and receiver, or both may be connected to the same power source. Supply cables should be shielded to prevent receiver radiation.

**Receiver:** The receiver employs a super-regenerative detector of the in-

directly heated cathode type. No better type of receiver has been developed for ultra-high frequencies to date. The enormous sensitivity of this type of receiver creates a background noise when no signals are received, but this noise is completely eliminated when a strong station carrier is tuned in. A super-heterodyne of equal sensitivity would have as great a noise level and an automatic volume control would be necessary. The super regenerative receiver has a perfect automatic volume control inherent with the detecting action. Automobile ignition interference is completely eliminated without the use of suppressors.

**Radiation Elimination:** Radiation from the detector and its attendant interference to other receivers is eliminated by the use of a screen grid tuned r.f. stage and careful shielding. The receiving antenna and receiver proper are shielded from detector radiation. If complete shielding is required, supply leads must be shielded as well. The r.f. stage is instrumental in appreciably increasing the signal to noise ratio and overall sensitivity.

**Receiver Audio Output:** The super-regenerative detector is followed by a stage of a.f. amplification. A volume control is introduced in this circuit as are tip jacks for headphone insertion. The final or output stage employs a power pentode capable of delivering 3.5 watts to the five inch dynamic speaker, which

is mounted behind the grill shown in the photograph.

**Antenna:** Type TR-53-6A6 may be used with  $\frac{1}{4}$  or  $\frac{1}{2}$  wave rods and single or two wire transmission lines of any length.

**Mounting:** The entire duplex unit is mounted on a removable panel, is housed in a black crackle finished steel case, and is provided with ventilating louvers and handles. The latter may be used for securing a strap for carrying or for fastenings in mobile use.

**Dimensions:** (Width) 15 x (Height)  $7\frac{1}{4}$  x (Depth)  $7\frac{1}{2}$  inches.

**Net Weight:** 16 $\frac{1}{2}$  pounds.

**Tubes:** Transmitter: 2 — 6A6 Twin Triodes and 1 6E6  
Receiver: 78, 76, 76, 42.

**Amateur Net Price: \$39.75**  
7 Tubes \$4.27.

**Power Supply:** 110 v. 60 cycle — Class B swinging and output chokes, 300 v. at 200 M.A., 6.3 v. at 3.4 amps and extra 2.5 v. at 10.75 amps. Complete with cables, plugs, pilot lamp and 5Z3 rectifier tubes \$25.53.

**E2-X Dynamotor:** Made to our specifications by Pioneer. Silver Band type, dust tight case, grease-sealed bearings, quiet smooth operation. Input 6 v. 15 A. Output 300 v. 175 M.A. Complete with U.H.F. filter. This is the unit used by Police Cars and Aircraft. Amateur net price \$45.00.

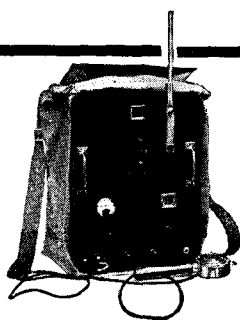

TYPE PTR-19  
Used to Broadcast

- The National Golf Open,
- Poughkeepsie Regatta,
- Arrival of the Queen Mary and other events to millions through national chains.

F.O.B. Factory, less tubes

**\$120.00**

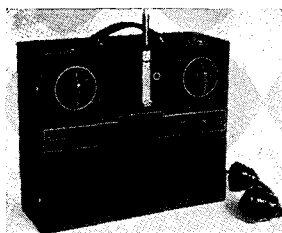

"THE COMPACT"

- Integral Batteries
- Five Tubes — 1A4, 30, 30, 19, 19
- 2 Watt Carrier
- 100% Modulation
- Duplex Operation

F.O.B. Factory, less tubes

**\$26.50**

ENGINEERING and CONSTRUCTION SERVICE for SPECIAL REQUIREMENTS

# radio transceiver

8627-115 STREET  
RICHMOND HILL, N. Y.

# laboratories

# BLILEY

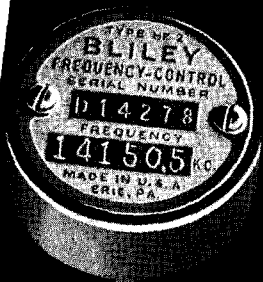
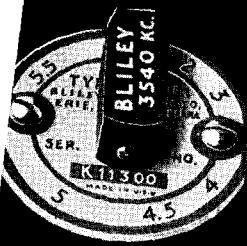

## TYPE VF 1

The Type VF 1 Variable Crystal Unit is a mounted low drift 80 meter crystal whose frequency is adjustable over a range of 6KC merely by turning the knob mounted on the holder. The frequency adjustment has no appreciable effect on the activity and stability of the crystal. The minimum frequency power output is the same as any Bliley LD2 Crystal Unit, while at the maximum frequency, the power output is decreased by only 20%. The VF 1 Unit plugs into any standard 5 prong tube socket and is not affected by position of mounting.

Price—minimum frequency within 5KC of specified . . . . . \$8.00

Price—minimum frequency at exact integral specified KC's . . . . . \$10.00

## TYPE LD 2

The Type LD2 Crystal Unit is the outstanding amateur crystal available today. It has a powerful, highly active crystal with a frequency drift of less than 4 cycles/MC/°C. Furnished in the 40, 80 and 160 meter amateur bands.

Price—Frequency within 5KC of specified, or choice from dealer's stock . . . \$4.80

Price—Frequency to exact integral specified KC's . . . . . \$5.90

## TYPE HF 2

The Type HF2 Crystal Unit is a mounted crystal designed especially for high frequency operation. It may be used for outputs at the fundamental, or for frequency multiplying to the 10 and 5 meter bands. The crystal is thicker than other cuts, possesses higher activity, and has a drift of only 20 cycles/MC/°C.

Price—14.0 to 14.4MC, within 15KC of specified frequency . . . . . \$6.50

Price—within 5KC of specified frequency \$10.00

Price—14.4 to 15.0MC, within 30KC of specified frequency . . . . . \$6.50

Price—within 5KC of specified frequency \$15.00

## TYPE BC 3

The Type BC3 Crystal Unit is an economically priced mounted X-cut power type crystal which possesses unusual activity and power output. Frequency drift is only 23 cycles/MC/°C. Holder plugs into standard 5 prong tube socket and may be mounted in any position. Supplied for the 40 and 80 meter amateur bands.

Price—within 5KC of specified frequency, or choice from dealer's stock . . . \$3.95

Price—frequency to exact integral specified KC's . . . . . \$4.95

**BLILEY ELECTRIC CO.**

Your Bliley dealer has a copy of the new Bliley 1937 Catalog which describes in detail the complete line of Bliley Crystals, Holders and Ovens for amateur and general communication frequencies.

# CRYSTALS

## TYPE VP 4

The Type VP4 Crystal Unit is for the discriminating amateur who desires the utmost in precision and stability. The crystal is inch square and has a frequency drift of less than 4 cycles/MC/°C. The holder is of low-loss glazed Steatite and incorporates an adjustable electrode pressure feature, which permits operation with the greatest efficiency. Supplied for the 40, 80 or 160 meter bands.

- Price—within 5KC of specified KC . . . \$12.00
- Price—within 1KC of specified KC . . . 15.00
- Price—exact specified frequency . . . 17.50

## TYPE CF 1

The Type CFI Crystal Filter Unit is a mounted precision quartz crystal for use in short wave receivers to provide the high degree of selectivity essential in modern radio communications. Each crystal is ground for maximum response and to have no spurious frequencies within 7KC of the fundamental. The CFI Unit may also be used in crystal oscillators for alignment or testing purposes. Supplied for I.F. frequencies of 456KC, 465KC, 500KC and 525KC.

- Price . . . . . \$5.50
- (choice of GR plugs or tube pins at no extra cost)

## TYPE CO 6

The Type CO6 Crystal Oven is designed for purchasers of Bliley HF2, BC3, or LD2 Crystal Units where the addition of temperature control is desired for greatest stability. The oven is connected to a 6-7.5 volt heater supply by means of flexible leads and fits snugly over the crystal holder in its socket. No circuit or transmitter changes are required to use this oven. The crystal temperature is held within a maximum variation of 2°C. of the fixed operating temperature of 50°C.

- Price . . . . . \$3.25

## TYPE SOC 100

The Type SOC 100 Standard Frequency Crystal Unit is a mounted low drift 100KC bar having a frequency drift of under 3 cycles/MC/°C. Included in this mounting is a tank coil of the proper characteristics for dependable operation. This unit, in a simple circuit, provides reliable accuracy for calibration of frequency meters, test oscillators, radio receivers, or frequency measurements in general. Holder plugs into standard 5 prong tube socket.

- Price—Type SOC 100 . . . . . \$18.50
- Price—Type SOC 100X—mounted 100KC  
X-cut bar, but less tank coil . . . \$9.50

ERIE, PENNA.



The Bliley Electric Company also manufactures a complete line of crystals, holders and ovens for operation between 20KC and 28MC. Bliley broadcast frequency crystals and ovens are approved by the F. C. C.

# Gordon

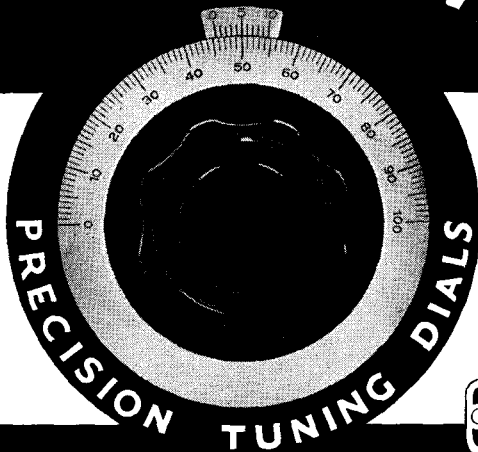

**STANDARD  
NAME PLATE**

2/3 Actual Size

**DE LUXE  
NAME PLATE**

2/3 Actual Size

**ANTENNA TUNING**

**CRYSTAL OSC. PLATE**

**DE LUXE NAME PLATES**

**STANDARD NAME PLATES**

Size: 2 1/2" x 1 1/2". Corners rounded. This size presents a most harmonizing appearance when used on or above 3" to 3 1/2" meters and 2 3/4" to 4" tuning dials. In addition, the size of GORDON De Luxe name plates allows for 3/16" high lettering, which is very clear and legible even at a distance. Made of brass, which is first nickel-plated and then chrome-plated, finished off in a soft satin grain. This makes an ever-lasting, non-tarnishable finish. Backgrounds are etched dull black.

List Price De Luxe Name Plates 15c Each

Your Cost 10 Cents Each

Size: 1 1/2" x 3/4". Corners rounded. The quality and appearance of the Standard line is identical to our De Luxe name plates. The material and finish of both the De Luxe and Standard lines far excel any other, including aluminum, German, and Nickel-Silver. The latter two both have a pleasing appearance when new, but they are highly tarnishable, especially near the seaside where the salty atmosphere has a corrosive effect.

List Price Standard Name Plates 10c Each

Your Cost 6 Cents Each

## LIST OF 106 NAME PLATES — DE LUXE OR STANDARD — AVAILABLE

Self-Tapping mounting screws are furnished with both DE LUXE and STANDARD name plates

Oscillator	3rd Buffer Grid	Antenna Tuning	Microphone	Pre-Selector
Oscillator Tank	3rd Buf. Gr. Tank	Ground	Microphone Cur.	Mixer No. 1
Crystal	1st Buf. Dblr. Plate	Neut. Condenser	Gain Control	Mixer No. 2
Crystal Osc. Plate	1st Buf. Dblr. Pl. Tank	Plate Voltage	Volume	Mixer No. 3
Crystal Osc. Grid	1st Buf. Dblr. Grid	Filament Voltage	% Modulation	Fader
Tritet Osc.	1st Buf. Dblr. Gr. Tank	Key	Transceiver	Power
Tripler Plate	2nd Buf. Dblr. Plate	Screen Current	Field	Speaker
Tripler Grid	2nd Buf. Dblr. Pl. Tank	Phone — CW	Heater Voltage	Radio
Cathode Tun. Cond.	2nd Buf. Dblr. Grid	Off — On	Generator	Record
Transmitter	2nd Buf. Dblr. Gr. Tank	Rectifier	Battery Charge	Tone
Buffer	3rd Buf. Dblr. Plate	Bias Voltage	Battery Discharge	Input
1st Buffer Plate	3rd Buf. Dblr. Pl. Tank	Send	Beat Oscillator	Output
1st Buf. Pl. Tank	3rd Buf. Dblr. Grid	Receive	Plate No. 1	200 Ohm Inpu
1st Buffer Grid	3rd Buf. Dblr. Gr. Tank	Send — Receive	Plate No. 2	200 Ohm Output
1st Buf. Gr. Tank	Doubler	Telegraph or CW	Coupling	500 Ohm Inpu
2nd Buffer Plate	Amplifier	Telephone	Excitation	500 Ohm Output
2nd Buf. Pl. Tank	Power Amp. Plate	Speech Amplifier	D. C. Inpu	500 Ohm Output
2nd Buffer Grid	P. A. Plate Tank	Modulator Plate	D. C. Output	50 Ohm Inpu
2nd Buf. Gr. Tank	Power Amp. Grid	Modulator Grid	A. C. Inpu	125 Ohm Output
3rd Buffer Plate	P. A. Grid Tank	Class B Modulator	A. C. Output	50 Ohm Inpu
3rd Buf. Pl. Tank	Antenna Cur.	Class A Modulator	Regeneration	125 Ohm Output

Individually engraved De Luxe name plates — you specify the wording desired — are available on special order

### GORDON DIALS

The only dials available in both direct drive and 5 to 1 vernier drive that are identical in appearance. Made of heavy gauge brass, chromium-plated, finished in a circular grain sun-ray satin that will not tarnish even by the seaside. The graduations are die stamped which assures accuracy (not to be confused with etched types which are less costly and less accurate). Spring mounted decimal indicators permit readings to one tenth of one division.

No. 292 — Dia. 4" direct drive dial. List price \$2.50 — your cost \$1.50

No. 294 — Dia. 2 3/4" direct drive dial. List price \$1.65 — your cost 90c

No. 296 — Dia. 4" vernier drive dial. List price \$6.50 — your cost \$3.90

See our catalog for additional dial listings and other items

### PLANETARY OR VERNIER UNIT

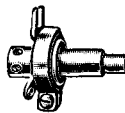

You can use this duo-ratio — 7 to 1 vernier and 1 to 1 direct drive — planetary assembly on all types of controls. Mounts on control shaft behind panel with drive shaft projecting through panel. Uses two knobs — one for the vernier drive and one for direct drive. About 1/2 actual size.

No. 599 — Vernier planetary unit only. List price \$1.50 — your cost 90c

No. 289 — Black bakelite knobs for above. List price, pair, 20c — your cost 12c

**GORDON SPECIALTIES COMPANY**  
440 SOUTH DEARBORN STREET, CHICAGO, ILLINOIS





2 Watts

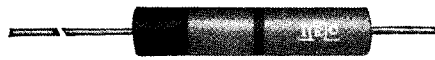

1 Watt



1/2 Watt

Type BT Insulated Metallized (Actual Size)

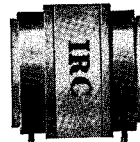

Type WW-3 Precision Wire Wound

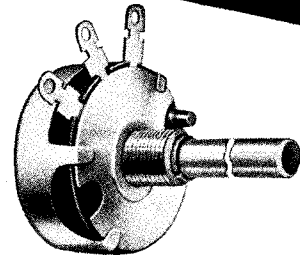

Type C Volume Control



Type WW-1 Precision Wire Wound

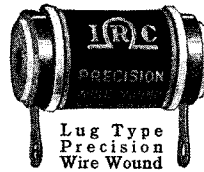

Lug Type Precision Wire Wound



Type MS Noise Suppressor

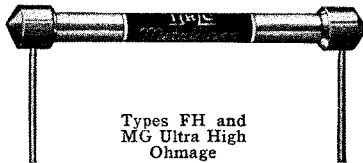

Types FH and MG Ultra High Ohmage



Type F Metallized

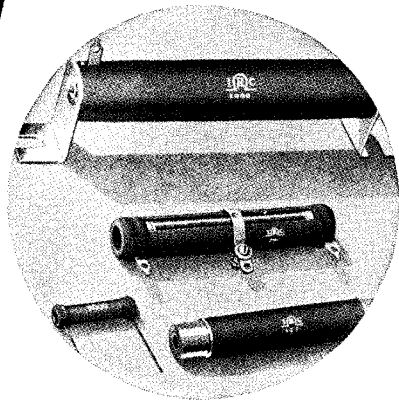

Heavy Duty Wire Wound Types



1/2 Watt



1 Watt  
Type BW Insulated Wire Wound (Actual Size)



Type MW Insulated Power Wire Wound (With Taps)



Type MW Insulated (Ferrule End) Wire Wound

TRANSMITTING AND SPECIAL PURPOSE TUBES

# RCA Communication Equipment

Amateur's		DESCRIPTION	Elec- trodes	Max. Plate Dissipation Watts	Cath- ode Type	Cath- ode Volts
Type	Net Price					
203-A	\$15.00	R-F Power Amplifier, Oscillator, Class B Modulator	3	100	Filament	10.0
204-A	97.50	Oscillator, R-F Power Amplifier, Class B Modulator	3	250	Filament	11.0
211	15.00	R-F Power Amplifier, Oscillator, A-F Power Amplifier, Modulator	3	100	Filament	10.0
800	10.00	R-F Power Amplifier, Oscillator, Class B Modulator	3	35	Filament	7.5
801	4.50	R-F and A-F Power Amplifier, Oscillator, Modulator	3	20	Filament	7.5
802	3.90	R-F Power Amplifier Pentode	5	10	Heater	6.3
803	38.50	R-F Power Amplifier Pentode	5	125	Filament	10.0
804	15.00	R-F Power Amplifier Pentode	5	40	Filament	7.5
805	18.00	R-F Power Amplifier, Oscillator, Class B Modulator	3	125	Filament	10.0
830-B	10.00	Class B Modulator, R-F Power Amplifier, Oscillator	3	60	Filament	10.0
831	265.00	Oscillator, R-F Power Amplifier	3	400	Filament	11.0
834	12.50	R-F Power Amplifier and Oscillator	3	50	Filament	7.5
837	8.50	R-F Power Amplifier Pentode	5	12	Heater	12.6
838	16.00	Class B Modulator, R-F Power Amplifier, Oscillator	3	100	Filament	10.0
840	6.00	R-F Pentode	5	—	Filament	2.0
841	3.25	R-F Power Amplifier, Oscillator A-F Voltage Amplifier	3	—	Filament	7.5
842	3.25	A-F Power Amplifier, Modulator	3	12	Filament	7.5
843	12.50	Power Amplifier, Oscillator	3	15	Heater	2.5
844	18.00	Screen-Grid R-F Power Amplifier	4	15	Heater	2.5
845	16.00	Modulator, A-F Power Amplifier	3	75	Filament	10.0
849	160.00	Modulator, A-F Power Amplifier, R-F Power Amplifier, Oscillator	3	400	Filament	11.0
850	37.50	Screen-Grid R-F Power Amplifier	4	100	Filament	10.0
851	350.00	Modulator, A-F Power Amplifier, R-F Power Amplifier, Oscillator	3	750	Filament	11.0
852	16.40	Oscillator, R-F Power Amplifier	3	100	Filament	10.0
860	32.50	Screen-Grid R-F Power Amplifier	4	100	Filament	10.0
861	295.00	Screen-Grid R-F Power Amplifier	4	400	Filament	11.0
864	1.60	Amplifier (Low Microphonic Design)	3	—	Filament	1.1
865	12.75	Screen-Grid R-F Power Amplifier	4	15	Filament	7.5
868	5.00	Phototube	2	—	—	—
917	6.00	Phototube (High-Vacuum Type)	2	—	—	—
918	5.00	Phototube (High Sensitivity)	2	—	—	—
919	6.00	Phototube (High-Vacuum Type)	2	—	—	—
920	7.00	Twin Phototube	4	—	—	—
954	5.80	Detector, Amplifier Pentode (Acorn Type)	5	—	Heater	6.3
955	3.75	Amplifier, Detector, Oscillator (Acorn Type)	3	—	Heater	6.3
956	5.80	Super-Control R-F Pentode (Acorn Type)	5	—	Heater	6.3
991	.90	Voltage Regulator	2	—	—	—
1602	2.75	Amplifier Triode (Low-Microphonic Type)	3	15	Filament	7.5
1603	2.25	Amplifier Pentode (Low-Microphonic Type)	5	—	Heater	6.3

Amateur's		RECTIFIERS	Elec- trodes	Max. Peak Inverse Volts	Cath- ode Type	Cath- ode Volts
Type	Net Price					
217-A	20.00	Half-Wave, High-Vacuum	2	3,500	Filament	10.0
217-C	20.00	Half-Wave, High-Vacuum	2	7,500	Filament	10.0
836	11.50	Half-Wave, High-Vacuum	2	5,000	Heater	2.5
866	1.75	Half-Wave, Mercury-Vapor	2	7,500	Filament	2.5
866-A	4.00	Half-Wave, Mercury-Vapor	2	10,000	Filament	2.5
872	14.00	Half-Wave, Mercury-Vapor	2	7,500	Filament	5.0
872-A	16.50	Half-Wave, Mercury-Vapor	2	10,000	Filament	5.0
873	11.00	Half-Wave, High-Vacuum for Cathode-Ray Tubes	2	20,000	Filament	2.5
879	3.00	Half-Wave, High-Vacuum for Cathode-Ray Tubes	2	7,500	Filament	2.5
885	2.00	Gas-Triode for Cathode-Ray Sweep-Circuit Control	3	300	Heater	2.5

Amateur's		HIGH-VACUUM CATHODE-RAY TUBES	Elec- trodes	Max. Anode No. 2 Volts	Cath- ode Type	Cath- ode Volts
Type	Net Price					
903	97.50	9 in., Electromagnetic Deflection, High-Vacuum	5	7,000	Heater	2.5
904	52.50	5 in., Electrostatic-Magnetic Deflection, High-Vacuum	5	4,600	Heater	2.5
905	45.00	5 in., Electrostatic Deflection, High-Vacuum	4	2,000	Heater	2.5
906	18.00	3 in., Electrostatic Deflection, High-Vacuum	4	1,200	Heater	2.5
907	48.75	5 in., Electrostatic Deflection, High-Vacuum, Short Persistence Screen	4	2,000	Heater	2.5
908	21.00	3 in., Electrostatic Deflection, High-Vacuum, Short Persistence Screen	4	1,200	Heater	2.5
909	49.00	5 in., Electrostatic Deflection, High-Vacuum, Long Persistence Screen	4	2,000	Heater	2.5
910	21.25	3 in., Electrostatic Deflection, High-Vacuum, Long Persistence Screen	4	1,200	Heater	2.5
911	22.50	3 in., Electrostatic Deflection, High-Vacuum, (Electron gun of low-magnetic material)	4	1,200	Heater	2.5
912	163.40	5 in., Electrostatic Deflection, High-Voltage, High-Vacuum	4	15,000	Heater	2.5

Prices effective Oct. 12, 1936. Prices subject to change or withdrawal without notice.

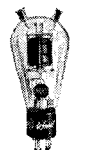

RCA 800



RCA 801



RCA 802



RCA 803



RCA 805



RCA 955

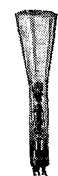

RCA 906

RCA Manufacturing Co., Inc.  
Camden, N. J.



For

# ... HIGH QUALITY ... LOW PRICE

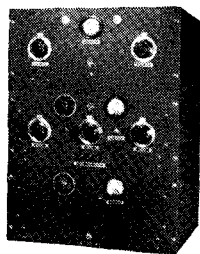

ACT 40

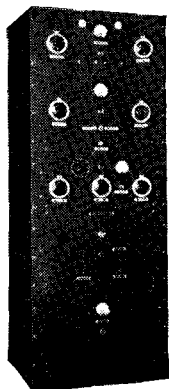

ACT 200

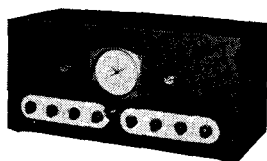

ACR 175

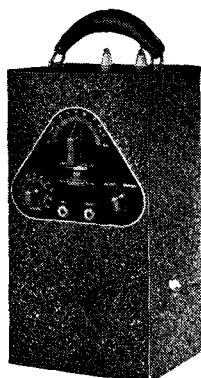

ATR 219

The ACT-40 Transmitter is nominally rated at 40 watts output on either 'phone or c.w. The r-f system employs an RCA-47 as a crystal oscillator, an RCA-802 as a buffer or doubler and two RCA-801's as final amplifiers. Coils are available for the 20, 40, 80 and 160 meter amateur bands. The a-f system employs an RCA-57 and RCA-56 as speech amplifiers, 2 RCA-45's as drivers and 2 RCA-801's as Class "B" Modulators. Individual units of the ACT-40 may be purchased separately. The price complete for 'phone operation with one set of coils but less tubes, crystals, microphone, key and other accessories is \$235.00.

The ACT-200 Transmitter is nominally rated at 200 watts output on 'phone and 250 watts output on c.w. The r-f system employs the r-f unit used in the ACT-40 to drive 2 RCA-838's in the power amplifier. The a-f system consists of a separate speech amplifier unit which mounts on the operating table, driver stages mounted in the transmitter proper, and 2 RCA-838's as Class "B" Modulators. Individual units of the ACT-200 may be purchased separately. Coils are available for 20, 40, 80 and 160 meter bands. Amateur's net price for ACT-200 with one set of coils but less tubes, crystals, microphone, key and other accessories, \$475.00.

The ACR-175 Receiver is an 11 tube superheterodyne covering from 500 to 60,000 kilocycles. Incorporating such advanced design features as magnetite-core i-f transformers, crystal filter, electron-ray tuning and signal-input measuring tube, two i-f stages, a.v.c., band-change switch, single-control tuning, this receiver is ideally suited for communication requirements. The amateur's net price complete with tubes, speaker and power supply is \$119.50.

The ATR-219 Transceiver is designed for operation by licensed amateurs in the five meter band. For transmitting, an RCA-19 is employed as a unity-coupled oscillator, another RCA-19 as a Class "B" Modulator and an RCA-30 as a speech amplifier. For receiving, one RCA-19 is used as a super-regenerative detector, the RCA-30 as an a-f amplifier, and the other RCA-19 as a Class "B" audio-output tube. Space is provided in the cabinet for batteries. The amateur's net price less tubes, batteries, headphones, microphone, etc., is \$19.95.

*Note: All prices are f.o.b. Factory and are subject to change or withdrawal without notice. For additional information on products listed or information on other RCA products, write to Amateur Radio Section, RCA Manufacturing Company, Inc., Camden, New Jersey.*

# Amateur Radio



AMATEUR EQUIPMENT



# Transmitting Condensers

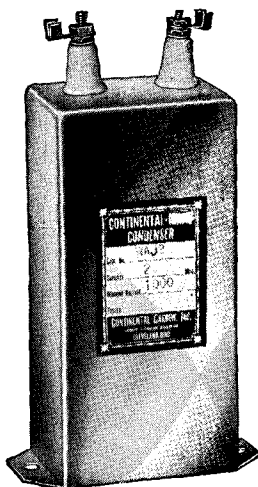

CONTINENTAL engineers have developed these compact high-voltage non-inductive condensers especially to meet the requirements of amateur transmitters.

They provide, at extremely reasonable price, a wax-impregnated high-voltage filter unit having the characteristics of an oil condenser, capable of withstanding severe overloads. Ratings are conservative. These new "W" condensers are not only compact but extremely attractive in appearance. Binding post

terminals are provided on top; these are the new type stand-off porcelain insulators. Convenient mounting ears are provided at the bottom.

Code	Mfds. Capacity	Voltage	Size			List
			H.	W.	D.	
WAJ1	1	1000	5"	2"	2"	\$2.10
WAJ2	2	1000	5"	2 1/2"	1 7/8"	3.30
WAJ4	4	1000	5"	2 1/2"	2 1/4"	4.85
WAE1	1	1500	5"	2 1/2"	1 7/8"	2.90
WAE2	2	1500	5"	2 1/2"	2 1/4"	3.90
WAE4	4	1500	5"	4"	3"	6.50
WBJ1	1	2000	5"	2 1/2"	1 7/8"	3.55
WBJ2	2	2000	5"	2 1/2"	2 1/4"	4.75
WBJ4	4	2000	5"	4"	3"	8.00

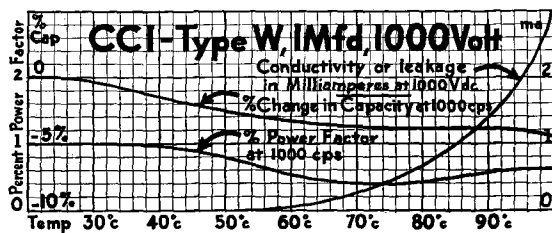

Characteristic curves of the CONTINENTAL Carbon Type W transmitting condensers indicate the excellent performance of these capacitors.

## CONTINENTAL CARBON CONDENSERS

All standard types of tubular, metal cased, and cardboard cased, non-inductive, wax-impregnated, paper dielectric capacitors are manufactured by CONTINENTAL Carbon Inc. Write for Bulletin 103.



### R.F. TRANSMITTING CHOKES

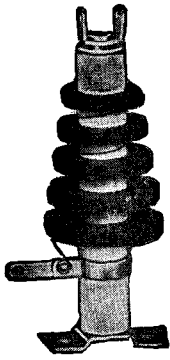

CI-20

A compact heavy-duty choke for the high power stage. Particularly suited to the 160, 80, 40 Meter bands. Wound with five continuous universal tapered pies on a one-half inch core, three inches long. The effective impedance is high enough to make parallel plate feed practical. The current carrying capacity is conservatively rated at .6 amp. continuous and .8 amp. intermittent service.

Inductance, 3.6 mh., D. C. resistance, 11 ohms; Size 3 5/8 in. x 1 1/8 in.

Type CI-20  
List Price \$1.25

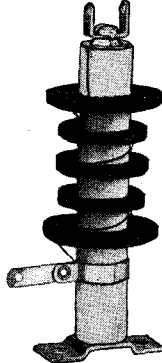

CI-21

Designed especially to offer maximum impedance at frequencies in the 80, 40, and 20 Meter bands. The pies are universal HONEYCOMB wound for low distributed capacity. This feature together with a unique winding method for obtaining a balanced distributed capacity between pies has resulted in a choke unparalleled in efficiency. Steatite core and current ratings similar to the CI-20.

Inductance, 1.1 mh.; D. C. resistance, 6 ohms; Size 3 5/8 in. x 1 1/4 in.

Type CI-21 List Price \$1.25

A popular choke applicable to high frequency receiver construction and low power transmitter stages. Wound on a Steatite core with four continuous universal pies, TAPERED to provide maximum impedance in the amateur bands. Fitted with nickel plated caps permitting either grid leak mounting or soldered connections. Inductance, 2.5 mh.; current carrying capacity, .125 amp.; D. C. resistance, 40 ohms; Size, 1 1/2 in. x 1/2 in.



CI-11

Type CI-11 List Price \$6.60

This unit meets a demand for a choke capable of carrying more current than the popular 125 ma. type. Retaining all the features of the CI-11, it will pass 250 milliamperes without heating. Inductance, 2.2 mh.; D. C. resistance, 18.5 ohms; Size, 1 1/2 in. x 5/8 in.

Type CI-12 List Price \$7.75

### COTO 5-METER CHOKE

A compact unit for transceivers, etc., where space is at a premium. Single layer winding on Steatite, capped and pig-tailed similar to the CI-11 and CI-12. Overall length, 1 1/2 in.

Type CI-13 List Price \$4.40



CI-13

### CONTROL WHEEL

THE NEW, MODERN Tuning Control for transmitters and electrical equipment. Molded of genuine bakelite and supplied complete with an aluminum scale, pointer, and choice of 22 interchangeable Indicator Plates. Inserts are standard for 1/4" shafts but may be had for 3/8 and 1/2" on special order.

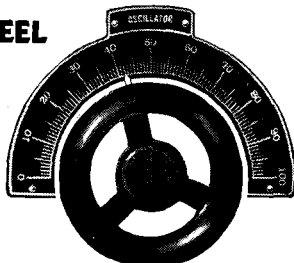

3 1/4 inch — TWO SIZES — 2 1/4 inch

Type	Description	List Price
CI-40	3 1/4" CONTROL WHEEL, complete	\$2.50
CI-41	3 1/4" CONTROL WHEEL, only	2.00
CI-45	2 1/4" CONTROL WHEEL, complete	2.00
CI-46	2 1/4" CONTROL WHEEL, only	1.50

### LOW-LOSS INDUCTORS

The modern way to work all bands. Highly efficient inductances available from 160 to 10 Meters for Tank, Buffer, or Antenna and equipped with plugs (including centertap) on standard mounting centers for rapid band change. Coils are wound with transparent enamel coated copper wire, each turn being cemented in its own slot for accuracy and ruggedness. Supporting strips are Cellulose Acetate, an excellent dielectric material having extremely low power factor

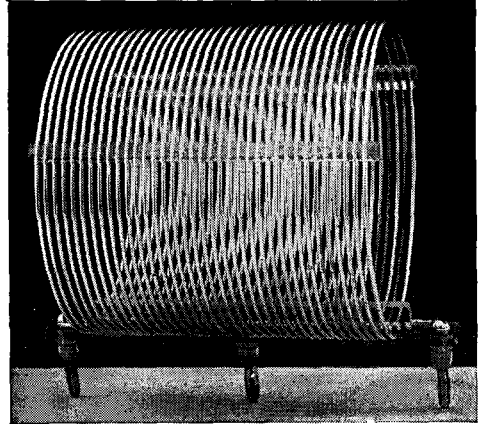

"T" SERIES — 1KW Cap  
Mtg. Centers — 7 1/2"  
Centertapped

"B" SERIES — 300W. Cap  
Mtg. Centers — 5 1/4"

"BT" Series same but centertapped at slight additional cost.

Type	List Price	Type	List Price
160T	\$3.25	160B	\$2.30
80T	2.75	80B	2.20
40T	2.40	40B	1.80
20T	1.90	20B	1.50
10T	1.80	10B	1.40

### MAGICORE I.F. TRANSFORMERS

Designed to meet the demand for greater selectivity on the Amateur Bands. Modernize your present Communication Receiver by installing a set of MAGICORE I.F. TRANSFORMERS. Three stages will reduce the I.F. Channel Bandwidth from an approximate 20KC. to from 3 to 5KC. wide, with gain equal to that of an air core amplifier. The Ultra-Selective Characteristic of the MAGICORE I.F. TRANSFORMERS is due to the use of a newly developed iron core composed of a magnesium-ferrous alloy resulting in a coil with a Q factor hitherto unattainable. Note extremely loose couplings.

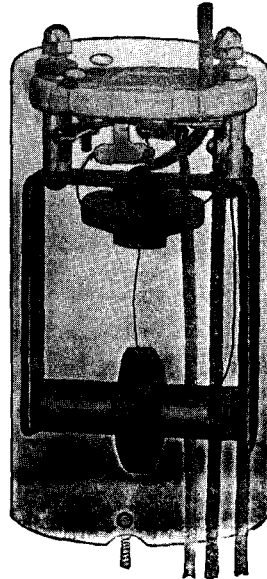

#### MAGICORE I.F. TRANSFORMERS

(Communication Type — 465 KC.)

CI-50	Interstage (58's or 6D6's)
CI-51	Crystal Input or Diode Det. Input (Secondary Centertapped)
CI-52	Crystal Output (Step-up to First I.F. Grid)

LIST PRICE \$2.00

COTO RADIO PRODUCTS and bulletins are available at all leading jobbers.  
List prices are subject to usual amateur discount.

**COTO-COIL COMPANY, Inc., PROVIDENCE, R. I.**

# Use These "Specialized Helps"

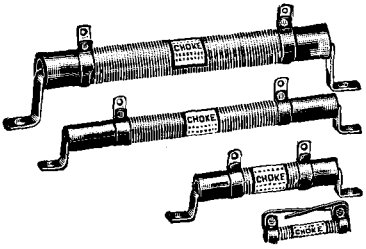

## R. F. PLATE CHOKES

At last! The many advantages of single layer winding are available in chokes for the plate circuit of transmitters up to 1000 M.A. plate current. These chokes are wound over ceramic tubes and coated with special moisture resisting enamel. Ample space at ends to prevent flash-over. Four sizes to cover six main amateur bands:

Stock No.	Amateur Bands, meters	Length	Diameter	List Price
Z-1	5	1 3/4"	5/8"	\$0.25
Z-2	10 and 20	3 "	3/8"	.75
Z-3	20 and 40	6 "	1/2"	1.10
Z-4	20, 40, 80 and 160	6 1/2"	7/8"	1.50

## Power RHEOSTATS

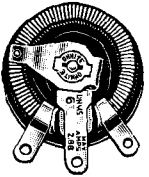

Tube manufacturers insist that exact value of filament voltage is imperative for longest life consistent with maximum output. OHMITE Rheostats provide close control in the primary of filament transformers for every tube type. Made in six sizes and many values. Listed with Underwriters' Laboratories.

Model	Watts	Diameter	Range (ohms)	List Price
H	25	1 1/2"	1-5000	\$4.00-\$4.75
J	50	2 1/4"	0.5-10,000	4.50-5.00
K	100	3 1/8"	0.5-10,000	7.00-9.00
L	150	4 "	0.5-10,000	9.00-12.00
N	300	6 "	1-2,500	13.50
R	500	8 "	1.5-2,500	19.50

## CORDOHM Line Cord Resistor

This unit is useful in building portable transmitters and receivers of low power where it is desirable to eliminate the weight of filament and plate transformers. Heavily insulated, made with non-breakable plug which prevents cord from unravelling. Stock numbers below indicate resistance in ohms of each model.



Stock No.	Voltage Drop in Filaments	List Price
C-330	18.0 to 24.0	\$ .55
C-290	25.0 to 31.5	.55
C-250	32.0 to 44.5	.55
C-220	45.0 to 52.0	.55
C-180	53.0 to 61.0	.55
C-160	62.0 to 68.9	.55
C-135	69.0 to 75.2	.55

## Multipoint TAPSWITCHES

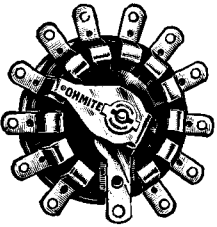

Suitable for many applications such as crystal and band-switching, switching tapped transformer primaries, meter switching, etc. All porcelain construction, ample insulation to handle heavy currents and high voltages. Units with four to eight points are only 2 3/4" in diameter; switches with nine to twelve points are 3 3/4" in diameter. Made in

both shorting type (\$4.25 to \$8.25 list) and non-shortening type (\$4.75 to \$8.75 list).

## Transmitting BANDSWITCH

No more cumbersome coil changing when you want to change transmitter frequency. Modern transmitters have one or more OHMITE Bandswitches mounted on the control panel for instant, flick-of-the-wrist frequency change. Low-loss, all-porcelain construction for best insulation against high voltages and frequencies. Diagrams for all basic circuits shown in Ohmite Amateur Handbook.

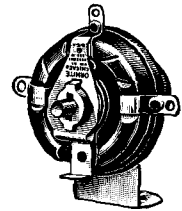

Stock No. BC-3. List Price.....\$3.00

## ORDER FROM YOUR DEALER AT REGULAR DISCOUNTS

The parts shown on these pages are carried in stock by dealers in all parts of the country. More detailed information (including complete lists of values with prices) will be found in OHMITE Catalog 14. Mail a postcard for your copy—FREE!

OHMITE

# for More Efficient Operation

## DIVIDOHM Semi-Variable Resistors

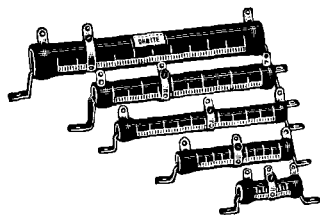

These units are widely used as bleeders in transmitter, receiver and C bias power supplies. Exclusive OHMITE Vitreous Enamel insulated. Patented percentage-of-resistance scale makes it easy

to set lugs for approximate values. Six sizes; more than 200 resistance values.

Watts	Size	Range (ohms)	List Price
25	2" x 3/8"	1 to 25,000	\$ .85 to \$1.10
50	4" x 3/8"	5 to 100,000	1.35 to 2.00
75	6" x 3/8"	5 to 100,000	1.75 to 2.50
100	6 1/2" x 7/8"	5 to 100,000	2.00 to 2.75
160	8 1/2" x 1 1/4"	5 to 100,000	2.50 to 3.25
200	10 1/2" x 1 1/4"	5 to 100,000	3.00 to 3.50

## Vitreous Enamel Fixed RESISTORS

The larger sizes make ideal power supply bleeders. Wound on porcelain core. Famous OHMITE Vitreous Enamel coating. More than 150 values in five sizes.

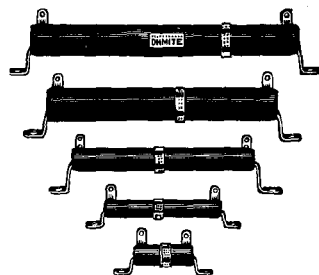

Watts	Size	Range (ohms)	List Price
25	2" x 3/8"	5 to 100,000	\$ .75 to \$1.75
50	4" x 3/8"	5 to 250,000	1.10 to 2.75
100	6 1/2" x 7/8"	5 to 100,000	1.50 to 2.50
160	8 1/2" x 1 1/4"	5 to 100,000	2.00 to 2.70
200	10 1/2" x 1 1/4"	5 to 100,000	2.50 to 3.00

## BROWN DEVIL Vitreous Resistors

These genuine wire-wound units, furnished in 10 and 20 watt sizes, afford ample protection against resistor failure, so often encountered when low wattage resistors are used. Wound on ceramic cores, and protected against mechanical and electrical damage by genuine OHMITE Vitreous Enamel.

Watts	Size	Range (ohms)	List Price
10	1 3/4" x 3/8"	1 to 25,000	\$ .40
20	2" x 1/2"	5 to 15,000	.65
20	2" x 1/2"	20,000 to 50,000	.75
20	2" x 1/2"	55,000 to 100,000	1.00



## RED DEVIL Cement Coated Resistors

Here is a genuine high-temperature resistor, similar to the BROWN DEVIL except that it is coated with a special high temperature refractory cement. The only unit to withstand the heat test in which a ten watt unit dissipates fifty watts.

Watts	Size	Range (ohms)	List Price
10	1 3/4" x 3/8"	1 to 25,000	\$ .40
20	2" x 1/2"	30,000 to 50,000	.75
20	2" x 1/2"	55,000 to 100,000	1.00

## WIREWATT One-Watt Resistors



High gain amplifiers will operate much more quietly when composition units are replaced with WIREWATTS, having no heat or voltage characteristics. Same size as composition units — will fit most radio circuits. Rated at one watt, furnished in 42 values from 100 to 25,000 ohms.

List Price.....\$.25

## Center-Tapped RESISTORS

Used to provide an electrical center where filament transformer has no center tap of its own. Furnished in BROWN DEVIL, RED DEVIL or WIREWATT types, as shown below.

Type	Watts	Range (ohms)	List Price
Brown Devil	10	10 to 200	\$ .50
Red Devil	10	10 to 200	.50
Wirewatt	1	10 to 200	.35

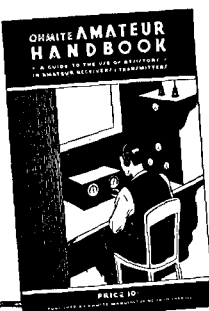
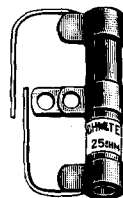

## Get Your REVISED SECOND EDITION of the OHMITE AMATEUR HANDBOOK

Last year's popular edition has been completely revised and enlarged to 24 pages. A whole new section has been added on bandswitching, with diagrams for most basic circuits. Another new chapter discusses plate choke applications for 5-to-160 meter transmitters. The new edition also contains data on modulators from 4 to 100 watts.

Last year's ingenious tables and charts have been revised and supplemented. They eliminate formulas and do away with difficult calculations. From your dealer or sent direct, 10c postpaid.

# IS YOUR XMTR \*HÆMOPHILIAC?



★ *A transmitter utilizing bleeders dissipating wattage in order to obtain correct operating potentials thereby reducing efficiency and impairing load regulation.*

Before modernizing your present equipment or buying a new plate transformer why not get the dope on our new exclusive triple winding plate transformer and compare it on merit alone with others. This new exclusive triple winding plate transformer provides the utmost in flexibility. Over 30 voltages are available ranging from 400 to 1600 volts. Regardless of revolutionary overnight changes in radio, this unit will never become obsolete. Low in price yet built to stand the gaff.

*Kenyon manufacturers, in addition, a complete line of quality audio products that defy competition both as to quality and price.*

Our new transmitter manual contains complete up-to-date transmitter circuits ranging in size from 5 watts to one kilowatt. Ten pages are entirely devoted to full page Ken-O-Grafs which cover most of the calculations used in radio in a modern and painless method. This book is no subterfuge for a catalog. To receive your copy send \$.25 in stamps or coin.

*Have you seen a copy of our monthly live-wire magazine, The Kenyon Engineering News? Write for sample copy today.*

Chief Engineer — Amateur Division

**KENYON TRANSFORMER CO., INC.**  
840 Barry Street, New York, N. Y.



# Use SHURE MICROPHONES

The specially-engineered microphone for Communications Work is an original Shure Development. In addition to the world famous 70S now doing notable duty in thousands of amateur phone stations, Shure Brothers now gives you a "Communications-Type" Microphone with "4-Way Utility" flexibility . . . outstanding performance plus a new "high" in utility and convenience!

For a complete listing of Shure Microphones, Stands and Accessories for every application, write for Bulletin 141H. We'll include FREE, on request, a copy of Microphone Applications and Specifications Chart 227H.



## 4-WAY UTILITY MICROPHONES — CRYSTAL and CARBON TYPES

You get 4 Microphones in One! Special handle and base with coupling makes possible a Desk type instrument for home use and a portable Hand microphone for field work . . . in one unit . . . plus adaptability for Stand Mounting or Ring Suspension whenever needed . . . at no extra cost. Here is real utility and economy for the "Phone Man"!

Shure 4-Way Utility Microphones are available in "Communications-Type" Crystal, General-Purpose Crystal, and Two-Button Carbon Types. All models are complete with special handle, base, adapter, 4 "Quickway" Hooks and Cable.

**Model 70SK.** "Communications-Type" Crystal Microphone specially designed for reproduction of speech. Doubles power on important intelligibility speech frequencies . . . produces

clear, crisp, powerful signals that cut through noise and static. List Price . . . . . \$26

**Model 70HK.** A General-Purpose Crystal Microphone for high quality reproduction of speech and music. List Price . . . . . \$27.50

**Model 10BK.** Two-Button Carbon Microphone for economical Amateur and P.A. use. List Price . . . . . \$12

**Model 70S.** Famous Shure "Communications-Type" Crystal Microphone. Complete with integral Desk Mount and 7 ft. shielded cable. List Price . . . . . \$25

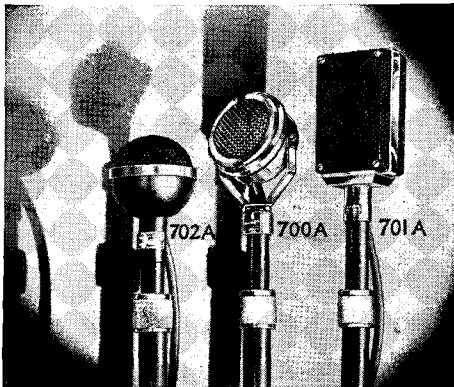

## New "Ultra" Wide-Range Crystal Microphones

These new Shure "Ultra" Microphones bring you amazingly life-like reproduction . . . dependable trouble-proof service . . . at low cost. They embody 8 exclusive Shure Features. Wide-Range reproduction approaching the most Rigid True High Fidelity standards makes them ideal wherever highly faithful reproduction is essential. Available in Spherical, Swivel and "Grille-Type" models as illustrated above. Complete with 7 ft. cable. List Price . . . . . \$25

Crystal Microphones licensed under patents of the Brush Development Company. Shure patents pending.

## Model 3B Two-Button Carbon Microphone

Model 3B is the lowest-priced full-size "standard brand" microphone available today. It is recommended for use where economy is most important. Rigid built-in protective grill. Finished in bright nickel plate. Complete with 4 "Quickway" Hooks. List Price . . . . . \$5.50

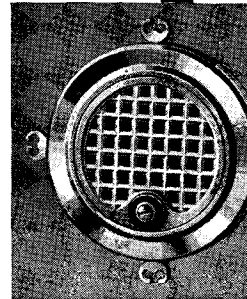

## Model 5B Two-Button Carbon Microphone

A full-size two-button Carbon Microphone with large adjustable precision buttons. Combines Performance, Style, and Quality Materials with low cost. Overall diameter 3 3/4". Polished chromium plated. List Price . . . . . \$10

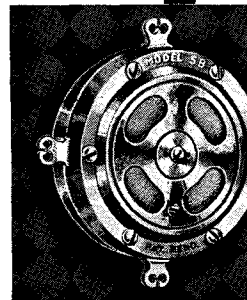

### Microphone Repair Service

Use our expert repair service for all types and makes of microphones. Write for quotations.

# SPRAGUE Transmitting CONDENSERS



- ▶ OIL IMPREGNATED
- ▶ OIL FILLED

! We don't attempt to sell anything on a price basis where real QUALITY is so absolutely essential as it is in Transmitting Condensers. However, we're glad to announce new low competitive prices which mean that amateurs no longer have to pay a premium to use the finest oil-impregnated, oil-filled units. You get extra quality at no extra price.

Remember: Spragues are the smallest size at the highest voltage and of the most popular type ever offered — and they're rated to conform to tube characteristics.

*DIRECT ORDERS from amateurs will be accepted if their jobbers do not stock Sprague Transmitting Condensers. Don't accept substitutes! You can get IMMEDIATE DELIVERY from us.*

Catalog Number	Capacity	D. C. Working Voltage	Surge Voltage	Old List Price	New List Price	New Net Price
OT-27	2 Mfd.	700 v	1000 v	\$3.50	\$3.00	\$1.80
OT-11	1 Mfd.	1000 v	1500 v	2.50	2.50	1.50
OT-21	2 Mfd.	1000 v	1500 v	4.00	3.35	2.01
OT-41	4 Mfd.	1000 v	1500 v	6.00	4.85	2.91
OT-115	1 Mfd.	1500 v	2000 v	4.00	2.85	1.71
OT-215	2 Mfd.	1500 v	2000 v	5.25	3.90	2.34
OT-12	1 Mfd.	2000 v	3000 v	4.75	3.55	2.13
OT-22	2 Mfd.	2000 v	3000 v	6.50	4.75	2.85
OT-13	1 Mfd.	3000 v	3500 v	10.00	8.50	5.10

## NEW! SPRAGUE

Just the thing to meet the rapidly growing need for extremely small, but reliable condensers! A year in the making — now ready — and they stand head and shoulders above ordinary small condensers. Conservatively rated at 525 volts, but actually will take surges as high as 560 to 580 volts. Will not break down. Sprague humidity proof sealing and many other features at no additional cost. 4 mfd. list price only 75c, net 45c; 8 mfd. list 95c, net 57c; 8-8 mfd. list \$1.50, net 90c.

SPRAGUE PRODUCTS CO. North Adams, Mass.



**SPRAGUE 600 LINE**

**SPRAGUE 450 VOLTS**

# JEFFERSON

Radio

**JEFFERSON ELECTRIC COMPANY**  
Bellwood ~ Illinois

### Filament and Plate Supply Transformers

Special filament and plate supply transformers are designed for amateur radio operators and manufacturers. A high quality line with simple forms of tubes for use in the high volume components in this category.

**FILAMENT TRANSFORMERS**

Single or combination secondary windings in various types of multiple adjustments, standard for the tubes given below. Each secondary is covered with a drop wire, where the full primary is covered for 120 volts.

Model	Primary	Secondary	Rating
Fig. 1	120	6.3, 2.5, 2.5, 2.5, 2.5, 2.5	100
Fig. 2	120	6.3, 2.5, 2.5, 2.5, 2.5, 2.5, 2.5	100
Fig. 3	120	6.3, 2.5, 2.5, 2.5, 2.5, 2.5, 2.5, 2.5	100
Fig. 4	120	6.3, 2.5, 2.5, 2.5, 2.5, 2.5, 2.5, 2.5, 2.5	100
Fig. 5	120	6.3, 2.5, 2.5, 2.5, 2.5, 2.5, 2.5, 2.5, 2.5, 2.5	100

**Plate Supply Transformers**

These plate supply transformers combine the best of materials and workmanship selected with care and are available in the following sizes:

Model	Primary	Secondary	Rating
Fig. 1	120	250, 250, 250, 250, 250, 250, 250, 250, 250, 250	100
Fig. 2	120	250, 250, 250, 250, 250, 250, 250, 250, 250, 250, 250	100
Fig. 3	120	250, 250, 250, 250, 250, 250, 250, 250, 250, 250, 250, 250	100
Fig. 4	120	250, 250, 250, 250, 250, 250, 250, 250, 250, 250, 250, 250, 250	100
Fig. 5	120	250, 250, 250, 250, 250, 250, 250, 250, 250, 250, 250, 250, 250, 250	100

**Driver, Modulation and Mixing Transformers**

**CLASS "B" DRIVER TRANSFORMERS**

Designed to operate the 6X4 tube under the condition where appreciable power is taken by the Class "B" amplifier tubes.

**MODULATION TRANSFORMERS**

Designed for coupling to Class "C" modulators. Will effectively handle the audio frequency secondary are designed to carry the full load of the Class "C" amplifier at all times.

**MIXING TRANSFORMERS**

These transformers are furnished in three sizes. These transformers are designed to handle the full load of the Class "C" modulator at all times.

The following pages contain brief descriptions of the many items making up the complete Jefferson line — each a leader in its field — each engineered in the most thorough and precise manner — of all materials and now skilfully labor — with a touch of experience dating to the very beginning of the electrical industry.

Catalog pages completely describing and illustrating the various lines briefly mentioned herein will be furnished on request.

## NEW

### P. P. 6L6 MODULATION TRANSFORMER

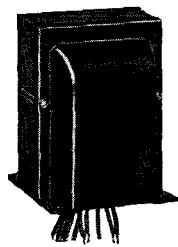

**60 Watts Capacity**  
Catalog No. 467-526

A newly developed unit for coupling push pull 6L6's to a Class "C" load. **Primary — 3800 ohms — push pull 6L6's.**

**Secondary — 7200 ohms — with 120 MA. D.C. or 3000 ohms — with 200 MA. D.C.**

For single 03A or two 800's.

**LIST PRICE . . . . \$9.00**

Order by Catalog No. 467-526

### NEW HEAVY DUTY 203A Modulation Transformer

A specially designed transformer of rugged construction for use with Heavy Duty Taylor 203A tubes.

A husky transformer of 500-watt audio capacity to modulate 2-150T's, 2-204A's, or 2-849's.

**Primary resistance, 8000 ohms; secondary, 3000, 4000, 6000 and 10000 ohms with 500 M.A. direct current.**

**Weight: 46 lbs.**

**LIST PRICE . . \$40.00**

Order by Catalog Number: 467-527

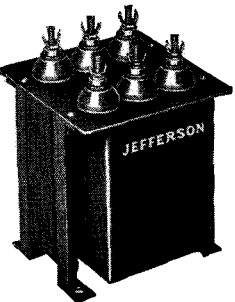

## Complete Line to Select From

Jefferson radio transformers meet all requirements of the amateur in applying iron core components to popular circuits. Filament transformers — plate supply, modulation, microphone and audio driver transformers are built to a standard of excellence which marks all Jefferson products.

Ask your wholesaler for a Jefferson catalog — or clip and mail the coupon below. JEFFERSON ELECTRIC COMPANY, Bellwood (Suburb of Chicago), Illinois. Canadian Factory: 535 College Street, Toronto.

Get Catalog and latest Amplifier Circuits.

JEFFERSON ELECTRIC COMPANY  
Bellwood, Ill.

Mail (free of charge) Radio Catalog and new Amplifier Diagrams

Name . . . . .

Street Address . . . . .

City and State . . . . .

**STABLE  
AS GIBRALTAR**

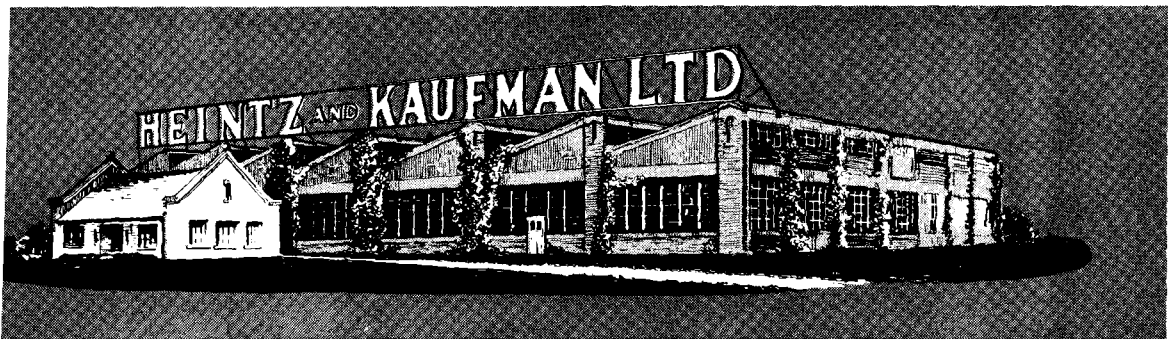

### **STABILITY**

Background and Experience is of prime importance in developing products to meet your requirements!

Gammatron transmitting tubes have been manufactured by Heintz and Kaufman Ltd. since 1928. Their quality has always been irreproachable.

Tantalum construction insures satisfaction and has been incorporated with Gammatrons continually since 1928, Heintz and Kaufman Ltd. having pioneered its application to transmitting tubes.

### **DEPENDABILITY**

Dependable performance is mandatory with amateur stations as well as commercial stations.

Gammatrons warrant your confidence equally with all other Heintz and Kaufman Ltd. products. Insist on the same tubes that are used in commercial installations.

*Our distributors are near you...let them supply full details  
or write direct for our latest Gammatron Data Sheets.*





IN KEEPING with its policy of providing all services within its power, The American Radio Relay League makes available to amateurs and would-be amateurs literature properly prepared to present in the best form all available information pertaining to amateur radio. The fact that its offices are the national and international headquarters of radio amateurs, makes League publications authoritative, complete, up-to-the-minute; written from a thoroughly practical amateur's point-of-view. These publications are frequently revised to keep abreast of the fast-changing field. All are printed in the familiar *QST* format which permits thorough but economical presentation of the information. Various invaluable printed forms, designed to facilitate compliance with the rules of good amateur practice, are available at moderate cost. We maintain to the best of our ability a stock of back copies of *QST* which are available at the original single-copy price. Many of the publications and supplies described in the following pages are handled by your dealer for your convenience.

The American Radio Relay League, Inc.

West Hartford, Connecticut





The  
**OFFICIAL**  
**MAGAZINE**  
of  
The  
**AMERICAN**  
**RADIO**  
**RELAY**  
**LEAGUE**

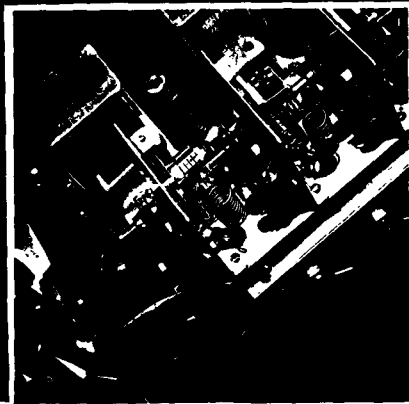

For twenty years (and thereby the oldest radio magazine) *QST* has been the "bible" of Amateur Radio. It faithfully and adequately reports each month the rapid development which makes Amateur Radio so intriguing. Edited in the sole interests of the members of The American Radio Relay League, who are its owners, *QST* treats of equipment and practices and construction and design, and the romance which is part of Amateur Radio, in a direct and analytical style which has made *QST* famous all over the world. It is essential to the well-being of any radio amateur. *QST* goes to every member of The American Radio Relay League and membership costs \$2.50 per year in the United States and Possessions, and Canada. All other countries \$3.00 per year. Elsewhere in this book will be found an application blank for A.R.R.L. membership.





# QST BACK COPIES

The back copies of *QST* contain the record of development of modern amateur technique. They are invaluable as technical references. Our supply of most issues is already exhausted, but many since 1925 are still available.

Please consult this list before ordering specific issues referred to in *QST* and *Handbook* texts.

1925 copies — (except Jan., Mar., May and July)	\$2.00
1926 copies — complete	2.50
1927 copies — (except January, July and October)	2.25
1928 copies — (except Jan., Feb., Mar., Aug., Sept.)	1.50
1929 copies — complete	2.50
1930 copies — (except January, February and July)	2.25
1931 copies — (except November)	2.50
1932 copies — (except Feb., July, Aug., Sept., Oct.)	1.75
1933 copies — (except January and February)	2.50
1934 copies — complete	2.50
1935 copies — complete	2.50
1936 copies — as issued, each 25c — complete year	2.50
1937 copies — as issued, each 25c — complete year	2.50
Single Copies, 25c Each, and Yearly Sets at Price Indicated, Postpaid	

Foreign add 50c for Yearly Sets



# QST YEARLY BINDERS

Those who take pride in the appearance of their lay-out and wish to keep their reference file of *QST*'s in a presentable manner, appreciate the *QST* binder. It is stiff-covered, finished in beautiful and practical maroon fabri-

koid. Cleverly designed to take each issue as received and hold it firmly without mutilation, it permits removal of any desired issue without disturbing the rest of the file. It accommodates 12 copies of *QST* and the yearly index. Opens flat at any page of any issue.

With each Binder is furnished a sheet of gold and black gummed labels for years 1919 through 1938. The proper one can be cut from the sheet and pasted in the space provided for it on the back of the binder.

A file of several years of *QST*, kept in order in binders, is a most valuable reference library for any Radio Amateur.

Price **\$1.50** postpaid

Available only in United States and possessions, and Canada





The *Handbook* tells the things which are needed for a comprehensive understanding of Amateur Radio. From the story of how Amateur Radio started through an outline of its wide scope of the present — from suggestions on how to learn the code through explanations of traffic-handling procedure and good operating practices — from electrical and radio fundamentals through the design, construction, and operation of amateur equipment — this book covers the subject thoroughly. It includes the latest and the best information on everything in Amateur Radio.

**\$1** POSTPAID  
\$1.25 OUTSIDE  
CONTINENTAL  
U. S. A.

*Buckram bound — \$2.50 postpaid*

Amateurs are noted for their ingenuity in overcoming by clever means the minor and major obstacles they meet in their pursuit of their chosen hobby. An amateur must be resourceful and a good tinkerer. He must be able to make a small amount of money do a great deal for him. He must frequently be able to utilize the contents of the junk box rather than buy new equipment. *Hints and Kinks* is a compilation of hundreds of good ideas which amateurs have found helpful. It will return its cost many times in money savings — and it will save hours of time.

*Price 50¢ postpaid*







Before you can operate an amateur transmitter, you must have a government license and an officially assigned call. These cost nothing — but you must be able to pass the examination. The License Manual tells how to do that — tells what you must do and how to do it. It makes a simple and comparatively easy task of what otherwise might seem difficult. In addition to a large amount of general information, it contains 198 typical questions and answers such as are asked in the government examinations. If you know the answers to the questions in this book, you can pass the examination without trouble.

Price **25¢** postpaid

Universally recognized as the standard elementary guide for the prospective amateur, **HOW TO BECOME A RADIO AMATEUR** describes, in clear understandable language, apparatus incorporating features hitherto confined to more advanced stations. Although completely modernized, the station can still be built at a minimum of expense, and the designs have been made flexible so that parts out of the junk box readily can be substituted. While easy to build, the performance of the equipment is such that any amateur can own and operate it with satisfaction and pleasure. Complete operating instructions and references to sources of detailed information on licensing procedure are given, as well as a highly absorbing narrative account of just what amateur radio is and does.

Price **25¢** postpaid





# LIGHTNING

by the

Aware of the practical bent of the average amateur and knowing of his limited time, the League, under license of the designer, W. P. Koechel, has made available several calculators to obviate the tedious and sometimes difficult mathematical work involved in the design and construction of radio equipment. The various lightning calculators are ingenious devices for rapid, certain and simple solution of the various mathematical problems which arise in all kinds of radio and allied work. They make it possible to read direct answers without struggling with formulas and computations. They are tremendous time-savers for

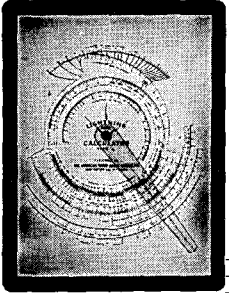

## RADIO CALCULATOR

### Type A

This calculator is useful for the problems that confront the average amateur every time he builds a new rig or rebuilds an old one or winds a coil or designs a circuit. It has two scales for physical dimensions of coils from one-half inch to five and one-half inches in diameter and from one-quarter to ten inches in length; a frequency scale from 400 kilocycles through 150 megacycles; a wave length-in-meters scale from two to 600 meters; a capacity scale from 3 to 1,000 micro-micro-farads; two inductance scales with a range of from one micro-henry through 1,500; a turns-per-inch scale to cover enameled or single silk covered wire from 12 to 35 gauge, double silk or cotton covered from 0 to 36 and double cotton covered from 2 to 36. Using these scales in the simple manner outlined in the instructions on the back of the calculator, it is possible to solve problems involving frequency in kilocycles, wave length in meters, inductance in micro-henrys and capacity in micro-farads, for practically all problems that the amateur will have in designing — from high-powered transmitters down to simple receivers. Gives the direct reading answers for these problems with accuracy well within the tolerances of practical construction.

**\$1.00**  
POSTPAID

## OHM'S LAW CALCULATOR

### Type B

This calculator has six scales:

A power scale from microwatts through 10 kilowatts.

A resistance scale from 0.1 ohms through 10 megohms.

A current scale from microamperes through 100 amperes.

A voltage scale from microvolts through 100 kilovolts.

A supplementary wire scale from 0 to 40 B. & S.

A decibel scale, plus and minus 40 db.

With this concentrated collection of tables, calculations may be made involving voltage, current, and resistance, and can be made with a single setting of a dial. The power or voltage or current or resistance in any circuit can be found easily if any two are known. The resistance in ohms per thousand feet of copper wire is shown to the limit of the B. & S. wire gauge scale. The power ratio of any two power values expressed in decibels can readily be obtained from the calculator, and instructions are also given for finding the answers when the value is greater than 40 db, the limit of the scale. All answers will be accurate within the tolerances of commercial equipment.

**\$1.00**  
POSTPAID





# CALCULATORS

## A.R.R.L.

amateurs, engineers, servicemen and experimenters. They are practically accurate and computations made by them have greater mathematical accuracy than can be measured by ordinary means. Each calculator has on its reverse side detailed instructions for its use; the greatest mathematical ability required is that of dividing or multiplying simple numbers. All calculators are printed in several colors and are wrapped in cellophane. You will find lightning calculators the most useful gadgets you ever owned.

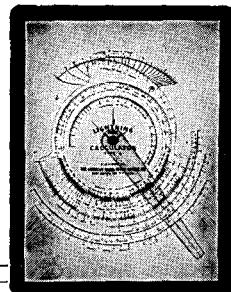

### Wire Data Calculator

#### Type C

Makes instantly available information on electrical conductors which would require hours of work and access to many textbooks. It has scales for dia. in mills, Stubbs and B&S wire gauges, current carrying capacity in milliamps, turns-per-inch and turns-per-centimeter for all kinds of insulated and bare wire, and a current-carrying-capacity scale for weather-proof and rubber-insulated wire. It gives turns per sq. in., ft. per lb., ohms per mi., ohms per km., ohms per 1000', volts lost per 1000' per amp., current carrying capacity at 1500 cm. per amp., lbs. per 1000', lbs. per mi., approximate tensile strength, ft. and meters per ohm, circular mills, equivalent in sq. wire. Nichrome, manganin, nickel, brass, aluminum, copper and silver wires are covered by these scales.

50¢ POSTPAID

### Decibel Calculator

#### Type D

With a scale each for input and output level in current or voltage or power, and a transmission loss or gain scale for either voltage or power ratio plus and minus 120 or 60 db., this calculator may be used in determining decibel gain or loss in four types of problems. When input and output voltages are known, when input and output currents are known, when input and output power are known, or when input voltage to receiver and output level are known. The decibel calculator gives an instant and clear picture of what a decibel is—its relation to power and voltage. Anyone having to do with amplifiers, transmission lines, directional antennas, etc., will appreciate this calculator.

50¢ POSTPAID

### Parallel Resistance Series Capacity Calculator

#### Type E

Solves easily an always confusing problem—the total effective resistance of two or more resistors in parallel, or the total effective capacity of two or more condensers in series. Direct reading answers for condensers or resistors of any size. A simple calculator but very useful.

50¢ POSTPAID

### Resistance Calculator

#### Type F

This calculator makes an ohm-meter of your voltmeter. With it, it is possible to measure the resistance of a resistor or circuit by using any voltmeter with a known voltage source of from 1 to 300 volts, such as a "B" battery. Has a range from 1 ohm to 1 megohm.

50¢ POSTPAID





# STATION OPERATING SUPPLIES

Designed by A.R.R.L. Communications Department

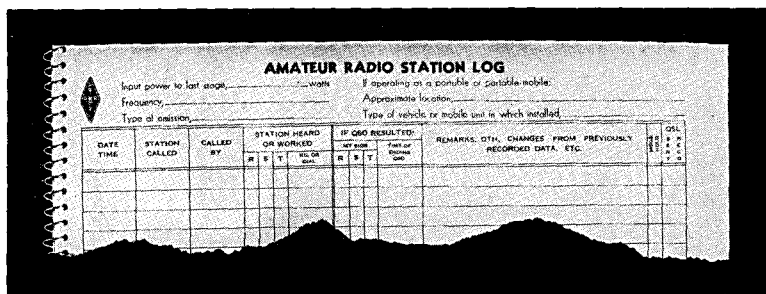

THE  
LOG  
BOOK

As can be seen in the illustration, the log page provides space for all facts pertaining to transmission and reception, and is equally as useful for portable or mobile operation as it is for fixed. The 38 log pages with an equal number of blank pages for notes, six pages of general log information (prefixes, etc.) and a sheet of graph paper are spiral bound, permitting the book to be folded back flat at any page, requiring only the page size of 8½ x 11 on the operating table. In addition, a number sheet for traffic handlers is included with each book. The LOG BOOK sells for 35c per book or 3 books for \$1.

## OFFICIAL RADIOGRAM PADS

The radiogram blank is now an entirely new form, designed by the Communications Department to comply with the new order of transmission. All blocks for fill-in are properly spaced for use in typewriter. It has a strikingly-new heading that you will like. Radiogram blanks, 8½ x 7¼, lithographed in green ink, and padded 100 blanks to the pad, are now priced at 25c per pad, postpaid.

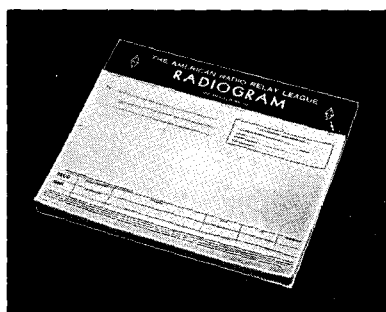

## and MESSAGE DELIVERY CARDS

Radiogram delivery cards embody the same design as the radiogram blank and are available in two

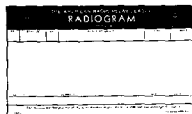

forms — on stamped government postcard, 2c each; unstamped, 1c each.





# MEMBERSHIP SUPPLIES

*Available only to A.R.R.L. members*

## *Insignia of the Radio Amateur*

In the January, 1920 issue of *QST* there appeared an editorial requesting suggestions for the design of an A.R.R.L. emblem — a device whereby every amateur could know his brother amateur when they met, an insignia he could wear proudly wherever he went. There was need for such a device. The post-war boom of amateur radio brought thousands of new amateurs on the air, many of whom were neighbors but did not know each other. In the July, 1920 issue the design was announced — the familiar diamond that greets you everywhere in Ham Radio — adopted by the Board of Directors at its annual meeting. It met with universal acceptance and use. For years it has been the unchallenged emblem of amateur radio, found wherever amateurs gathered, a symbol of the traditional greatness of that which we call Amateur Spirit — treasured, revered, idealized.

### *Do You Wear the A.R.R.L. Pin?*

THE LEAGUE EMBLEM, with both gold border and lettering, and with black enamel background, is available in either pin (with safety clasp) or screw-back button type.

In addition, there are special colors for Communications Department appointees.

- Red enameled background for the SCM.
- Blue enameled background for the ORS or OPS.

(Red available in pin type only. Blue may be had in either pin or button style.)

THE EMBLEM CUT: A mounted printing electrotype,  $\frac{5}{8}$ " high, for use by members on amateur printed matter, letterheads, cards, etc.

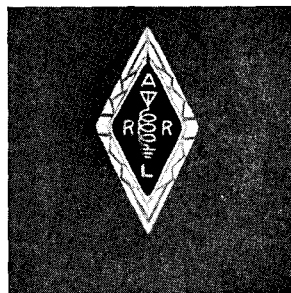

ALL EMBLEMS PRICED THE SAME

**50c**

POSTPAID



## STATIONERY

Members' stationery is standard  $8\frac{1}{2}$  x 11 bond paper which every member should be proud to use for his radio correspondence. Lithographed on  $8\frac{1}{2}$  x 11 heavy bond paper.

**100 Sheets, 50c**

**250 Sheets, \$1.00**

**500 Sheets, \$1.75**

POSTPAID





# TWO HUNDRED METERS AND DOWN

## *The Story of Amateur Radio*

by CLINTON B. DESOTO

A detailed, concise presentation in full book length of all the elements that have served to develop the most unique institution of its kind in the history of the world. A book of history but not a history-book. **TWO HUNDRED METERS AND DOWN: The Story of Amateur Radio** tells in spirited, dramatic fashion the entire chain of significant events in the development of the art.

Part I — From the dawn of the art to the time of the World War. Part II — Spark to C.W.; the progress and recognition accorded to amateur radio. Part III — From the first trans-oceanic communication through development of the short waves. Readjustment and regulation of amateur radio. Its part in expeditions and emergencies. Concluding with an evaluation of the arguments for the future of amateur radio.

Most of today's amateurs have no more than fragmentary knowledge of the beginnings of their art. This book is an invaluable record that every amateur ought to own, to learn thereby the fascinating tale of our earlier days.

*Approximately 200 pages, 90,000 words,  
with durable imitation leather red  
paper cover*

**\$1.00 postpaid**

*Deluxe edition bound  
in blue cloth*

**\$2.00**

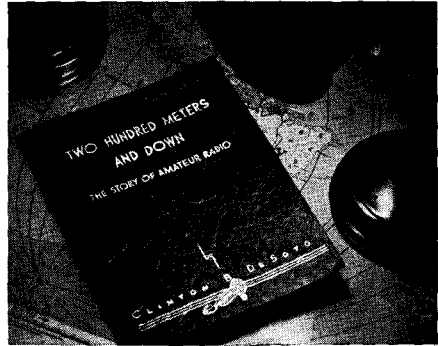

**A.R.R.L.**

**Amateur Radio**

**MAP**

**of the World**

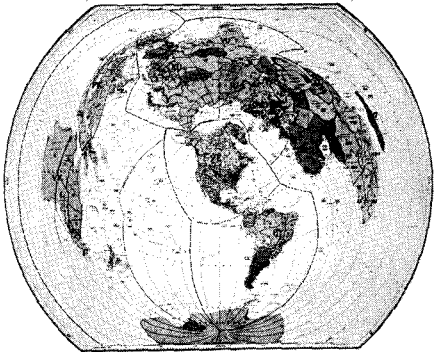

A map entirely new in conception and design, contains every bit of information useful to the radio amateur. A special type of projection made by Rand, McNally to A.R.R.L. specifications. It gives great circle distance measurements in miles or kilometers within an accuracy of 2%. Shows all principal cities of the world; local time zones and Greenwich; WAC divisions; 230 countries, indexed; 180 prefixes, districts and subdivisions, where used; and U. S. examining points. Large enough to be usable, printed in six colors on heavy map paper, 30 x 40 inches.

**Price \$1.25 postpaid**





# THE AMATEUR'S BOOKSHELF

A balanced selection of good technical books, additional to the A.R.R.L. publications, should be on every amateur's bookshelf. We have arranged, for the convenience of our readers, to handle through the A.R.R.L. Book Department those works which we believe to be most useful. Make your selection from the following, add to it from time to time and acquire the habit of study for improvement. *Prices quoted include postage. Please remit with order.*

## RADIO THEORY AND ENGINEERING

**FUNDAMENTALS OF RADIO**, *Second Edition*, by *R. R. Ramsey*. A modernized revision of the author's work which has been a favorite with amateurs and experimenters since 1929. 426 pages, 439 illustrations. Price..... **\$3.50**

**SHORT WAVE WIRELESS COMMUNICATION**, by *A. W. Ladner and C. R. Stoner*. Not a "how-to-make-it" book, but a text satisfying the needs of practical engineers and advanced amateurs by its thorough treatment of principles and practices in short-wave transmission and reception. The chapters on modulation, aeriads and feeders are especially good. 348 pp., 201 illustrations..... **\$3.75**

**COMMUNICATION ENGINEERING**, by *W. L. Everitt*. A general text for both first year and advanced courses. 567 pp., 335 illustrations..... **\$5.00**

**RADIO ENGINEERING**, by *F. E. Terman*. A comprehensive treatment covering all phases of radio communication. A good all around book for students and engineers. 688 pp., 418 illustrations..... **\$5.00**

**MANUAL OF RADIO TELEGRAPHY AND TELEPHONY**, by *Commander (now Admiral) S. S. Robison, U. S. N.* Published by the Naval Institute. Covers both the theoretical and practical fields. 791 pp., 6 1/4 x 9..... **\$4.00**

**ELEMENTS OF RADIO COMMUNICATION**, by *Prof. J. H. Morecroft*. This is the 2nd edition of this book by the author of the "Principles" listed elsewhere. It is about half the size of the larger work, and the subject is treated in more elementary fashion. Simple algebra is sufficient. An excellent book for the "first-year" student. 279 pp., 170 illustrations..... **\$3.00**

**PRINCIPLES OF RADIO COMMUNICATION**, by *Prof. J. H. Morecroft*. An elaborate general textbook, and one of the recognized standards on theory for the engineering student. A working knowledge of mathematics is desirable for the reader who expects to get the greatest benefit from this work. 1001 pp., 5 1/4 x 9..... **\$7.50**

**PRINCIPLES OF RADIO**, by *Keith Henney*. This book is chock-full of meat for the experimenter. The subjects treated range from the fundamentals of electricity to the modern concepts of modulation and detection. 477 pp., 306 illustrations..... **\$3.50**

**THEORY OF THERMIONIC VACUUM TUBES**, by *E. L. Chaffee*. Based on Dr. Chaffee's research and study at Harvard University, this book offers much new material and many new presentations, especially in connection with regeneration. Recommended particularly for advanced study. 652 pp., 360 illustrations..... **\$6.00**

## RADIO EXPERIMENTS AND MEASUREMENTS

**MEASUREMENTS IN RADIO ENGINEERING**, by *F. E. Terman*. A comprehensive engineering discussion of the measurement problems encountered in engineering practice, with emphasis on basic principles rather than on methods in detail. A companion volume to the same author's Radio Engineering, 400 pages, including an appendix of outlines for laboratory experiments and a comprehensive index. 210 illustrations. Price..... **\$4.00**

**THE CATHODE-RAY TUBE AT WORK**, by *John F. Rider*. Every owner and user of a cathode-ray oscilloscope should have his copy of this book. The first 109 pages are devoted to cathode-ray tube theory, sweep circuits, a.c. wave patterns and description of commercial oscilloscope units (the author prefers to call them "oscillographs"); the next 205 pages are packed with practical information on how to use them, including actual photographs of screen patterns representing just about every condition likely to be encountered in audio- and radio-frequency amplifiers, power supplies, complete receivers and transmitters. 322 pages, 44 illustrations. Price **\$2.50**

**RADIO FREQUENCY ELECTRICAL MEASUREMENTS**, by *H. A. Brown*. A thoroughly practical book for the experienced

amateur, the experimenter or engineer who has knowledge of the elementary principles of radio communication and of alternating currents..... **\$4.00**

**HIGH-FREQUENCY MEASUREMENTS**, by *August Hund*. A thorough, modern book, especially useful in advanced laboratory work. Includes a chapter on piezo-electric determinations. 491 pp., 373 illustrations..... **\$5.00**

**EXPERIMENTAL RADIO ENGINEERING**, by *Prof. J. H. Morecroft*. An excellent laboratory text directed specifically to emphasizing the principles involved in the operation of radio apparatus and intended as a companion to the same author's "Principles." Following an introductory chapter on instruments and accessories, 51 choice experiments are outlined. 345 pp., 250 illustrations..... **\$3.50**

**EXPERIMENTAL RADIO**, by *Prof. R. R. Ramsey*. Revised Edition. A splendid book for the experimenter. This is a laboratory manual, describing 128 excellent experiments designed to bring out the principles of radio theory, instruments and measurements. 150 illustrations, 229 pp., 5 1/4 x 7..... **\$2.75**

## COMMERCIAL EQUIPMENT AND OPERATING

**PRACTICAL RADIO COMMUNICATION**, by *A. R. Nilson and J. L. Hornung*. A new modern treatment meeting the expanded scope of today's technical requirements in the various commercial fields. The first six chapters are devoted to principles, the remaining nine to latest practice in broadcasting, police systems, aviation radio and marine communication. 754 pages, including an appendix of tabulated data and a complete topical index. 434 illustrations. Price **\$5.00**

**RADIO THEORY AND OPERATING**, by *Mary Texanna Loomis*. Although giving a moderate amount of theory, it is essentially a practical handbook for commercial and broadcast operators, and as such ranks among the foremost publications of this sort. Used as a textbook by many radio schools. A good book for any amateur. 1000 pp., 800 illustrations..... **\$3.00**

**THE RADIO MANUAL**, by *George E. Sterling*. Another excellent practical handbook, especially valuable to the commercial and

broadcast operator, and covering the principles, methods and apparatus of all phases of radio activity. Over 900 pp..... **\$6.00**

**RADIO TRAFFIC MANUAL AND OPERATING REGULATIONS**, by *Duncan and Drew*. A book for students, amateurs or radio operators who contemplate entering the commercial field; it will enable you to learn quickly and easily all the government and commercial traffic rules and operating regulations. 181 pp..... **\$2.00**

**RADIO OPERATING QUESTIONS AND ANSWERS**, by *Nilson and Hornung*. A companion volume to "Practical Radio Telegraphy" by the same authors. The latest Revised Edition is very complete, covering Commercial and Broadcasting, Amateur, Aeronautical and Police Radio, Beacons, Airways, Meteorology, and Teletype Operating. 389 pp., 5 1/4 x 8..... **\$2.50**

## MISCELLANEOUS

**THE RADIO AMATEUR CALL BOOK**. Lists all U. S. and foreign amateur radio stations, s.w. commercials and broadcasters..... **\$1.25** (Foreign **\$1.35**)

**MAKING A LIVING IN RADIO**, by *Zeh Bouck*. 222 pages, 25 illustrations. A worthwhile book for the radio amateur who is considering entering the Commercial Radio field in its many branches; explodes the bunk, points out the pitfalls..... **\$2.00**

**RADIO DATA CHARTS**, by *R. T. Beatty*. A series of graphic charts for solving, without the use of mathematics, most of the problems involved in receiver design. 82 pp., 8 1/4 x 11..... **\$1.50**

**SERVICING RECEIVERS BY MEANS OF RESISTANCE MEASUREMENTS**, by *J. F. Rider*. 203 pp., 94 illustrations..... **\$1.00**

**WHO'S WHO IN AMATEUR RADIO**. Gives photos, personal and station data on over 3000 amateurs. Also includes comprehensive list of radio clubs, s.w. commercials, etc. 172 pp., 140 photos..... **\$1.50**

**RADIO DESIGN PRACTICE**, by *James Millen and M. B. Sleeper*. A new type of book giving mechanical dimensions and electrical specifications of components and illustrating complete units of 10 manufacturers, with catalog listings appended. Over 150 pages exclusive of the catalog section. Price..... **\$1.00**





To manufacturers of products used  
in Short-Wave Radio Communication:

**T**HE Radio Amateur's Handbook is the world's standard reference on the technique of short-wave radio communication. It is universally used by amateurs, engineers, and experimenters. Fifty thousand copies a year are sold in America and all other countries. We offer to manufacturers whose integrity is established and whose products meet the approval of the technical staff of the A.R.R.L., the use of space in the Catalog Section of the Handbook. At a cost far less than any other method of producing and distributing a catalog, this accomplishes its production in the easiest possible manner, and provides adequate distribution and permanent availability impossible to attain by any other means.

Advertising Department  
American Radio Relay League  
West Hartford, Conn.

